

ISL267817

12-Bit Differential Input 200kSPS SAR ADC

FN7877  
Rev 2.00  
April 19, 2012

The ISL267817 is a 12-bit, 200kSPS sampling SAR-type ADC which features excellent linearity over supply and temperature variations, and provides a drop-in compatible alternative to all ADS7817 performance grades. The robust, fully-differential input offers high impedance to minimize errors due to leakage currents, and the specified measurement accuracy is maintained with input signals up to the supply rails.

The reference accepts inputs between 0.1V to 2.5V, providing design flexibility in a wide variety of applications. The ISL267817 also features up to 8kV Human Body Model ESD survivability.

The serial digital interface is SPI compatible and is easily interfaced to popular FPGAs and microcontrollers. Operating from a 5V supply, power dissipation is 2.15mW at a sampling rate of 200kSPS, and just 25µW between conversions utilizing the Auto Power-Down mode, making the ISL267817 an excellent solution for remote industrial sensors and battery-powered instruments. It is available in the compact, industry-standard 8 Lead SOIC and MSOP packages and is specified for operation over the industrial temperature range (-40°C to +85°C).

Features

- Drop-In Compatible with ADS7817 (All Performance Grades)
- Differential Input
- Simple SPI-compatible Serial Digital Interface
- Guaranteed No Missing Codes
- 200kHz Sampling Rate
- +4.75V to +5.25V Supply
- Low 2.15mW Operating Power (200kSPS)
- Power-down Current between Conversions: 3µA
- Excellent Differential Non-Linearity (1.0LSB max)
- Low THD: -85dB (typ)
- Pb-Free (RoHS Compliant)
- Available in SOIC and MSOP Packages

Applications

- Remote Data Acquisition
- Battery Operated Systems
- Industrial Process Control
- Energy Measurement
- Data Acquisition Systems
- Pressure Sensors
- Flow Controllers

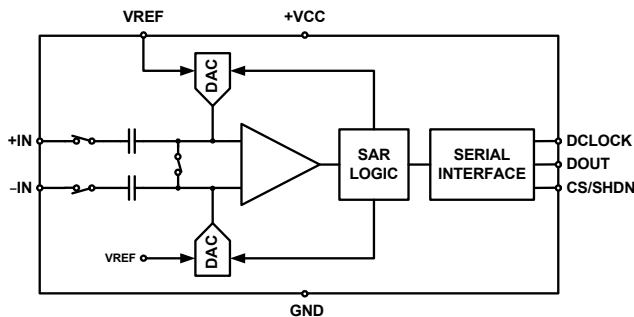

FIGURE 1. BLOCK DIAGRAM

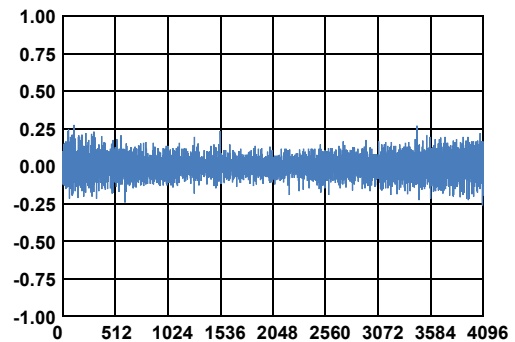
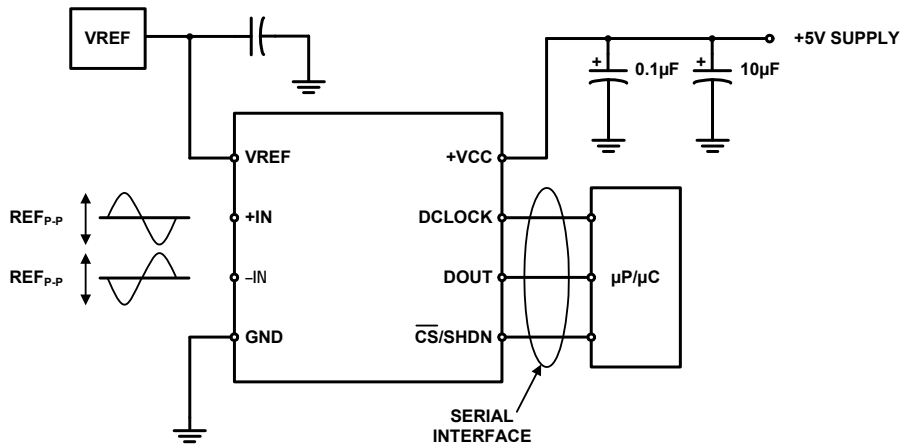

FIGURE 2. DIFFERENTIAL LINEARITY ERROR vs CODE

## Typical Connection Diagram



## Pin Configuration

ISL267817  
(8 LD SOIC, MSOP)  
TOP VIEW

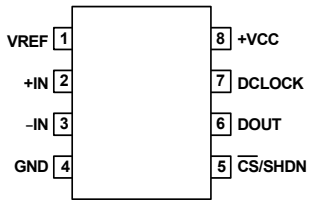

## Pin Descriptions

PIN NAME	PIN NUMBER	DESCRIPTION
VREF	1	Reference Input
+IN	2	Non Inverting Input
-IN	3	Inverting Input
GND	4	Ground
$\overline{\text{CS}}/\text{SHDN}$	5	Low = Chip Select, High = Shutdown
DOUT	6	Serial Output Data
DCLOCK	7	Data Clock
+VCC	8	Power Supply

## Ordering Information

PART NUMBER (Notes 1, 2, 3)	PART MARKING	+VCC RANGE (V)	TEMP RANGE (°C)	PACKAGE	PKG. DWG. #
ISL267817IBZ	267817 IBZ	4.75 to 5.25	-40 °C to +85 °C	8 Ld SOIC	M8.15
ISL267817IUZ	67817	4.75 to 5.25	-40 °C to +85 °C	8 Ld MSOP	M8.118

### NOTES:

1. Add "-T\*" suffix for tape and reel. Please refer to [TB347](#) for details on reel specifications.
2. These Intersil Pb-free plastic packaged products employ special Pb-free material sets, molding compounds/die attach materials, and 100% matte tin plate plus anneal (e3 termination finish, which is RoHS compliant and compatible with both SnPb and Pb-free soldering operations). Intersil Pb-free products are MSL classified at Pb-free peak reflow temperatures that meet or exceed the Pb-free requirements of IPC/JEDEC J STD-020.
3. For Moisture Sensitivity Level (MSL), please see device information page for the [ISL267817](#). For more information on MSL please see tech brief [TB363](#).

---

## Table of Contents

<b>Typical Connection Diagram</b> .....	<b>2</b>
<b>Pin Descriptions</b> .....	<b>2</b>
<b>Absolute Maximum Ratings</b> .....	<b>4</b>
<b>Thermal Information</b> .....	<b>4</b>
<b>Electrical Specifications</b> .....	<b>4</b>
<b>Timing Specifications</b> .....	<b>5</b>
<b>Typical Performance Characteristics</b> .....	<b>8</b>
<b>Functional Description</b> .....	<b>11</b>
ADC Transfer Function .....	11
Analog Input .....	11
Voltage Reference Input .....	12
Power-Down/Standby Modes .....	13
Dynamic Mode .....	13
Static Mode .....	13
Short Cycling .....	13
Power-on Reset .....	13
Power vs Throughput Rate .....	13
<b>Serial Digital Interface</b> .....	<b>14</b>
Data Format .....	14
Terminology .....	14
<b>Application Hints</b> .....	<b>15</b>
Grounding and Layout .....	15
<b>Revision History</b> .....	<b>16</b>
<b>Products</b> .....	<b>16</b>
<b>Package Outline Drawing (M8.15)</b> .....	<b>17</b>
<b>Package Outline Drawing (M8.118)</b> .....	<b>18</b>

**Absolute Maximum Ratings**

Any Pin to GND	-0.3V to +6.0V
Analog Input to GND	-0.3V to +VCC+0.3V
Digital I/O to GND	-0.3V to +VCC+0.3V
Digital Input Voltage to GND	-0.3V to +VCC+0.3V
Maximum Current In to Any Pin	10mA
<b>ESD Rating</b>	
Human Body Model (Tested per JESD22-A114F)	8kV
Machine Model (Tested per JESD22-A115B)	400V
Charged Device Model (Tested per JESD22-C101E)	1.5kV
Latch Up (Tested per JESD78C; Class 2, Level A)	100mA

**Thermal Information**

Thermal Resistance (Typical)	$\theta_{JA}$ (°C/W)	$\theta_{JC}$ (°C/W)
8 Ld SOIC Package (Notes 4, 5)	120	64
8 Ld MSOP Package (Notes 4, 5)	165	64
Operating Temperature	-40°C to +85°C	
Storage Temperature	-65°C to +150°C	
Junction Temperature	+150°C	
Pb-Free Reflow Profile	see link below	
	<a href="http://www.intersil.com/pbfree/Pb-FreeReflow.asp">http://www.intersil.com/pbfree/Pb-FreeReflow.asp</a>	

**CAUTION:** Do not operate at or near the maximum ratings listed for extended periods of time. Exposure to such conditions may adversely impact product reliability and result in failures not covered by warranty.

**NOTES:**

- $\theta_{JA}$  is measured with the component mounted on a high effective thermal conductivity test board in free air. See Tech Brief [TB379](#) for details.
- For  $\theta_{JC}$ , the “case temp” location is taken at the package top center.

**Electrical Specifications** +VCC = +5V,  $f_{DCLOCK} = 3.2\text{MHz}$ ,  $f_S = 200\text{kSPS}$ ,  $V_{REF} = 2.5\text{V}$ ;  $V_{CM} = V_{REF}$ . Typical values are at  $T_A = +25^\circ\text{C}$ . **Boldface limits apply over the operating temperature range, -40°C to +85°C.**

SYMBOL	PARAMETER	TEST CONDITIONS	MIN (Note 6)	TYP	MAX (Note 6)	UNITS
<b>ANALOG INPUT (Note 7)</b>						
AIN	Full-Scale Input Span	+IN – (-IN)	<b>-VREF</b>		<b>+VREF</b>	V
	Absolute Input Voltage	+IN	<b>-0.3</b>		<b>+VCC +0.3</b>	V
		-IN	<b>-0.3</b>		<b>+VCC +0.3</b>	V
$C_{VIN}$	Input Capacitance	Sample/Hold Mode		13/6		pF
$I_{LEAK}$	Input DC Leakage Current		<b>-1</b>	0.01	<b>1</b>	$\mu\text{A}$
<b>SYSTEM PERFORMANCE</b>						
N	Resolution		<b>12</b>			Bits
	No Missing Codes		<b>12</b>			Bits
INL	Integral Nonlinearity		<b>-1</b>	$\pm 0.5$	<b>1</b>	LSB
DNL	Differential Nonlinearity		<b>-1</b>	$\pm 0.4$	<b>1</b>	LSB
OFFSET	Zero-Code Error		<b>-6</b>	$\pm 0.25$	<b>6</b>	LSB
GAIN	Gain Error		<b>-4</b>	$\pm 0.12$	<b>4</b>	LSB
CMRR	Common-Mode Rejection			80		dB
PSRR	Power Supply Rejection			82		dB
<b>SAMPLING DYNAMICS</b>						
$t_{CONV}$	Conversion Time	$f_{DCLOCK} = 3.2\text{MHz}$			<b>12</b>	Clk Cycles
$t_{ACQ}$	Acquisition Time		<b>1.5</b>			Clk Cycles
$f_{max}$	Throughput Rate				<b>200</b>	kSPS
<b>DYNAMIC CHARACTERISTICS</b>						
THD	Total Harmonic Distortion	$V_{IN} = 5.0V_{P-P}$ at $f_{IN} = 1\text{kHz}$		<b>-85</b>		dB
		$V_{IN} = 5.0V_{P-P}$ at $f_{IN} = 5\text{kHz}$		<b>-84</b>		dB
SINAD	Signal-to (Noise + Distortion) Ratio	$V_{IN} = 5.0V_{P-P}$ at $f_{IN} = 1\text{kHz}$		<b>71</b>		dB
SFDR	Spurious Free Dynamic Range	$V_{IN} = 5.0V_{P-P}$ at $f_{IN} = 1\text{kHz}$		<b>85</b>		dB
BW	Full Power Bandwidth	At -3dB		<b>15</b>		MHz

**Electrical Specifications** +VCC = +5V, f<sub>DCLOCK</sub> = 3.2MHz, f<sub>S</sub> = 200kSPS, V<sub>REF</sub> = 2.5V; V<sub>CM</sub> = V<sub>REF</sub>. Typical values are at T<sub>A</sub> = +25°C. Boldface limits apply over the operating temperature range, -40°C to +85°C. (Continued)

SYMBOL	PARAMETER	TEST CONDITIONS	MIN (Note 6)	TYP	MAX (Note 6)	UNITS
<b>REFERENCE INPUT</b>						
VREF	VREF Input Range		<b>0.1</b>		<b>2.5</b>	V
VREFLEAK	Current Drain		<b>-100</b>	4	<b>100</b>	μA
		f <sub>SAMPLE</sub> = 12.5kHz	<b>-20</b>	0.23	<b>20</b>	μA
		$\overline{\text{CS}}/\text{SHDN} = +\text{VCC}$	<b>-3</b>	0.01	<b>3</b>	μA
<b>DIGITAL INPUT/OUTPUT</b>						
	Logic Family		CMOS			
V <sub>IH</sub>	Input High Voltage		<b>3</b>		<b>+VCC + 0.3</b>	V
V <sub>IL</sub>	Input Low Voltage		<b>-0.3</b>		<b>0.8</b>	V
V <sub>OH</sub>	Output High Voltage	I <sub>OH</sub> = -250μA	<b>3.5</b>			V
V <sub>OL</sub>	Output Low Voltage	I <sub>OL</sub> = 250μA			<b>0.4</b>	V
	Output Coding		Two's Complement			
I <sub>LEAK</sub>	Input Leakage Current		<b>-1</b>		<b>1</b>	μA
C <sub>IN</sub>	Input Capacitance			10		pF
I <sub>OZ</sub>	Floating-State Output Current		<b>-1</b>		<b>1</b>	μA
C <sub>OUT</sub>	Floating-State Output Capacitance			5		pF
<b>POWER REQUIREMENTS</b>						
V <sub>CC</sub>	Supply Voltage Range		<b>4.75</b>		<b>5.25</b>	V
I <sub>CC</sub>	Supply Current			430	<b>800</b>	μA
		f <sub>SAMPLE</sub> = 12.5kHz (Notes 8, 9)		38		μA
		f <sub>SAMPLE</sub> = 12.5kHz (Note 9)		223		μA
	Power Down Current	$\overline{\text{CS}}/\text{SHDN} = +\text{VCC}$ , f <sub>SAMPLE</sub> = 0Hz		0.5	<b>3</b>	μA
<b>TEMPERATURE RANGE</b>						
	Specified Performance		<b>-40</b>		<b>+85</b>	°C

## NOTES:

- Compliance to datasheet limits is assured by one or more methods: production test, characterization and/or design.
- The absolute voltage applied to each analog input must be between GND and +VCC to guarantee datasheet performance.
- f<sub>DCLOCK</sub> = 3.2MHz,  $\overline{\text{CS}}/\text{SHDN} = +\text{VCC}$  for 241 clock cycles out of every 256.
- See "Power vs Throughput Rate" on page 13 for more information regarding lower sample rates.

**Timing Specifications** Limits established by characterization and are not production tested. +VCC = 5V, f<sub>DCLOCK</sub> = 3.2MHz, f<sub>S</sub> = 200kSPS, V<sub>REF</sub> = 2.5V; V<sub>CM</sub> = V<sub>REF</sub>. Boldface limits apply over the operating temperature range, -40°C to +85°C.

SYMBOL	PARAMETER	TEST CONDITIONS	MIN (Note 6)	TYP	MAX (Note 6)	UNITS
t <sub>SMPL</sub>	Analog Input Sample Time		<b>1.5</b>		<b>2.0</b>	Clk Cycles
t <sub>CONV</sub>	Conversion Time			12		Clk Cycles
f <sub>CYC</sub>	Throughput Rate				<b>200</b>	kHz
t <sub>CSD</sub>	$\overline{\text{CS}}/\text{SHDN}$ Falling Edge to DCLOCK Low				<b>0</b>	ns
t <sub>SUCS</sub>	$\overline{\text{CS}}/\text{SHDN}$ Falling Edge to DCLOCK Rising Edge		<b>30</b>			ns
t <sub>hDO</sub>	DCLOCK Falling Edge to Current DOUT Not Valid		<b>15</b>			ns

**Timing Specifications** Limits established by characterization and are not production tested. +VCC = 5V,  $f_{DCLOCK} = 3.2\text{MHz}$ ,  $f_S = 200\text{kSPS}$ ,  $V_{REF} = 2.5\text{V}$ ;  $V_{CM} = V_{REF}$  **Boldface limits apply over the operating temperature range, -40°C to +85°C. (Continued)**

SYMBOL	PARAMETER	TEST CONDITIONS	MIN (Note 6)	TYP	MAX (Note 6)	UNITS
$t_{dDO}$	DCLOCK Falling Edge to Next DOUT Valid			35	<b>150</b>	ns
$t_{DIS}$	$\overline{CS}/\text{SHDN}$ Rising Edge to DOUT Disable Time	See Note 10		40	<b>50</b>	ns
$t_{EN}$	DCLOCK Falling Edge to DOUT Enabled			22	<b>100</b>	ns
$t_f$	DCLOCK Fall Time			1	<b>100</b>	ns
$t_r$	DCLOCK Rise Time			1	<b>100</b>	ns

NOTE:

10. During characterization,  $t_{DIS}$  is measured from the release point with a 10pF load (see Figure 4) and the equivalent timing using the ADS7817 loading (3kΩ, 100pF) is calculated.

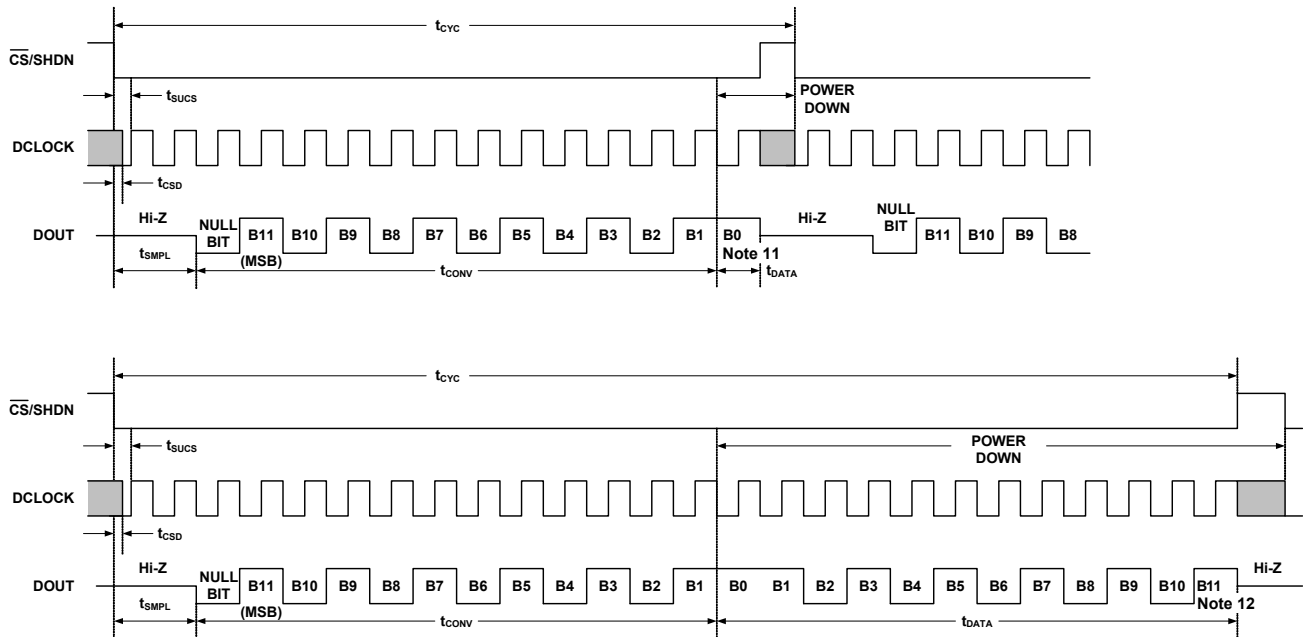

NOTES:

- 11. After completing the data transfer, additional clocks applied while  $\overline{CS}/\text{SHDN}$  is low will result in the previous data being retransmitted LSB-first, followed by indefinite transmission of zeros.
- 12. After completing the data transfer, additional clocks applied while  $\overline{CS}/\text{SHDN}$  is low will result in indefinite transmission of zeros.

FIGURE 3. SERIAL INTERFACE TIMING DIAGRAM

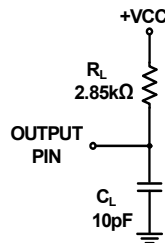

FIGURE 4. EQUIVALENT LOAD CIRCUIT

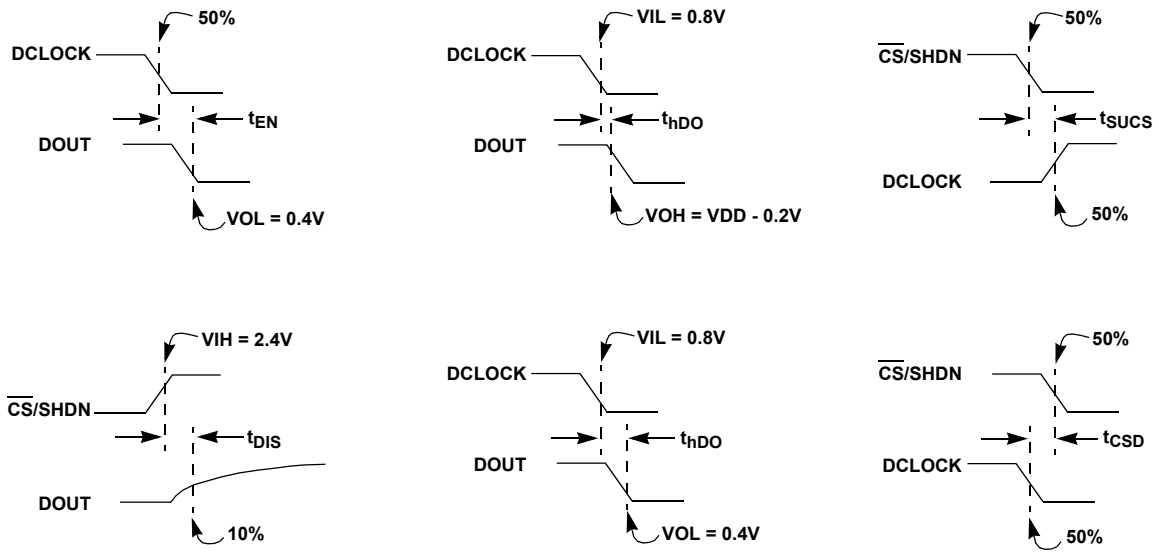

FIGURE 5. TIMING PARAMETER DEFINITIONS

# Typical Performance Characteristics

$T_A = +25^\circ\text{C}$ ,  $V_{CC} = 5\text{V}$ ,  $V_{REF} = 2.5\text{V}$ ,  $f_{\text{SAMPLE}} = 200\text{kHz}$ ,

$f_{\text{CLK}} = 16 * f_{\text{SAMPLE}}$ , unless otherwise specified.

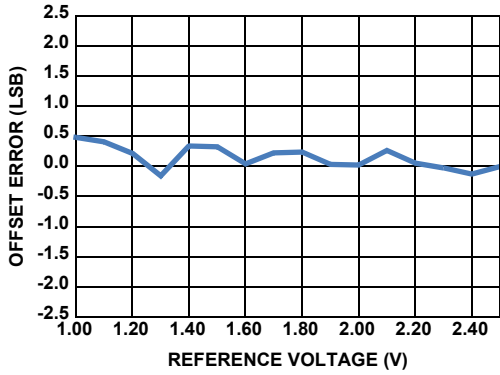

FIGURE 6. CHANGE IN OFFSET vs REFERENCE VOLTAGE

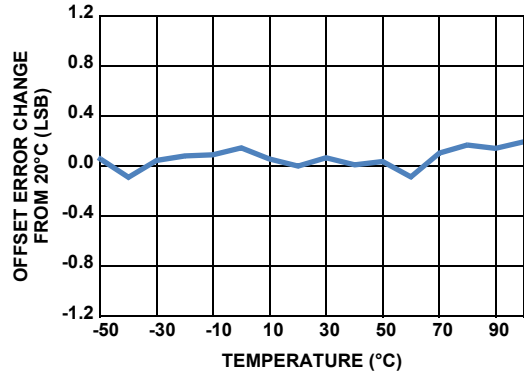

FIGURE 7. CHANGE IN OFFSET vs TEMPERATURE

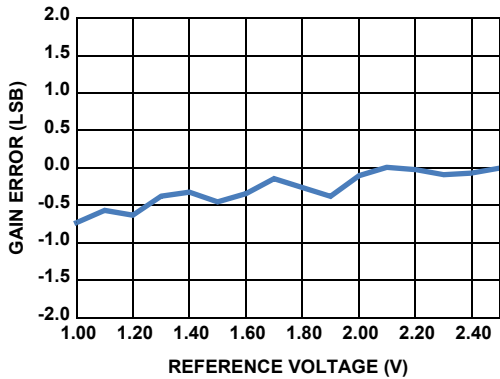

FIGURE 8. CHANGE IN GAIN vs REFERENCE VOLTAGE

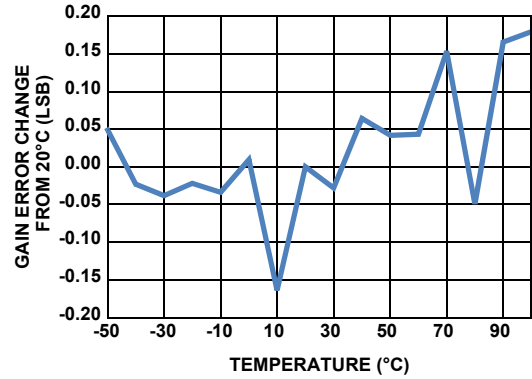

FIGURE 9. CHANGE IN GAIN vs TEMPERATURE

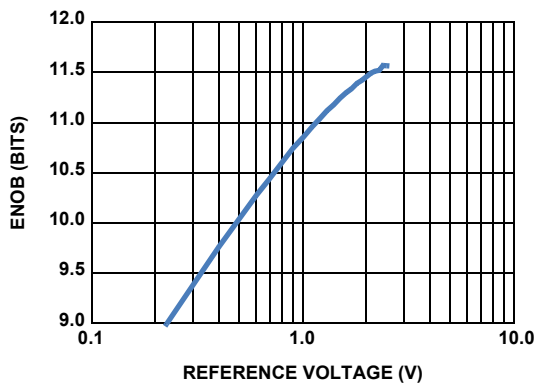

FIGURE 10. EFFECTIVE NUMBER OF BITS vs REFERENCE VOLTAGE

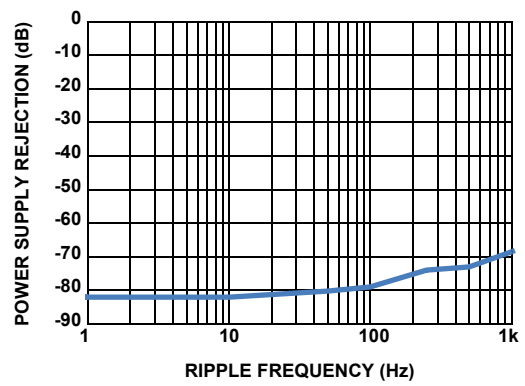

FIGURE 11. POWER SUPPLY REJECTION vs RIPPLE FREQUENCY



**Typical Performance Characteristics**  $T_A = +25^\circ\text{C}$ ,  $V_{CC} = 5\text{V}$ ,  $V_{REF} = 2.5\text{V}$ ,  $f_{\text{SAMPLE}} = 200\text{kHz}$ ,  
 $f_{\text{CLK}} = 16 * f_{\text{SAMPLE}}$ , unless otherwise specified. (Continued)

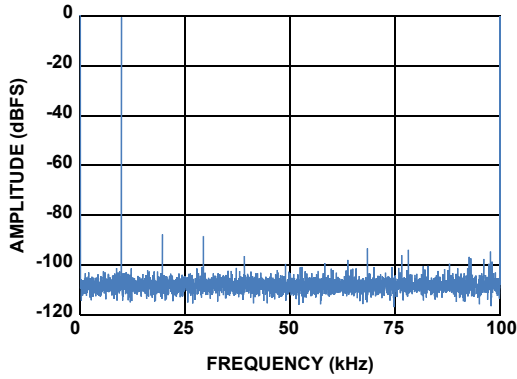

FIGURE 12. FREQUENCY SPECTRUM (8192 POINT FFT);  $f_{\text{IN}} = 9.9\text{kHz}$ ,  $-0.5\text{dB}$

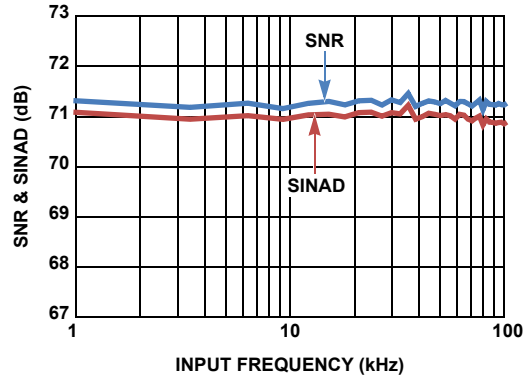

FIGURE 13. SIGNAL-TO-NOISE RATIO AND SIGNAL-TO-(NOISE+DISTORTION) vs INPUT FREQUENCY

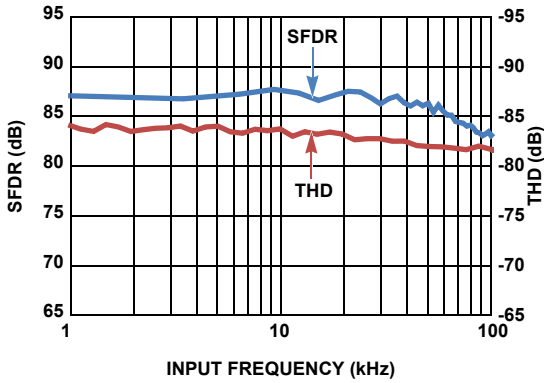

FIGURE 14. SPURIOUS FREE DYNAMIC RANGE AND TOTAL HARMONIC DISTORTION vs INPUT FREQUENCY

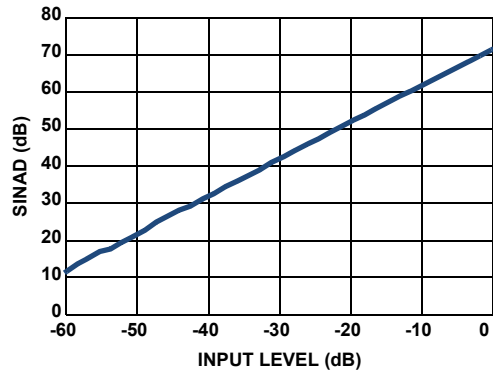

FIGURE 15. SIGNAL-TO-(NOISE+DISTORTION) vs INPUT LEVEL

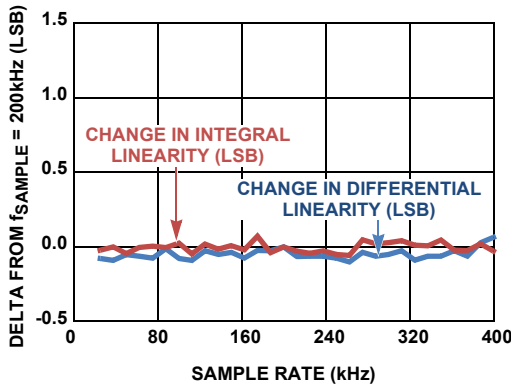

FIGURE 16. CHANGE IN INTEGRAL LINEARITY and DIFFERENTIAL LINEARITY vs SAMPLE RATE

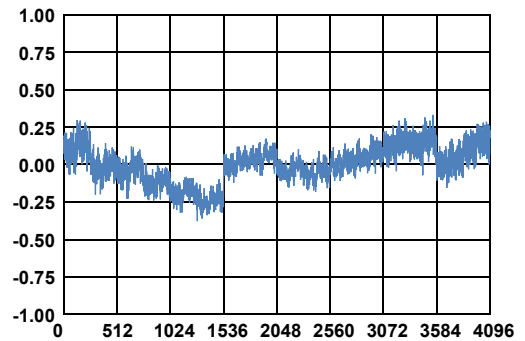

FIGURE 17. INTEGRAL LINEARITY ERROR vs CODE

# Typical Performance Characteristics

$T_A = +25^\circ\text{C}$ ,  $V_{CC} = 5\text{V}$ ,  $V_{REF} = 2.5\text{V}$ ,  $f_{\text{SAMPLE}} = 200\text{kHz}$

$f_{\text{CLK}} = 16 * f_{\text{SAMPLE}}$ , unless otherwise specified. (Continued)

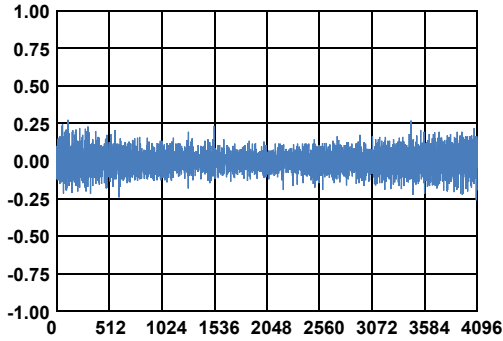

FIGURE 18. DIFFERENTIAL LINEARITY ERROR vs CODE

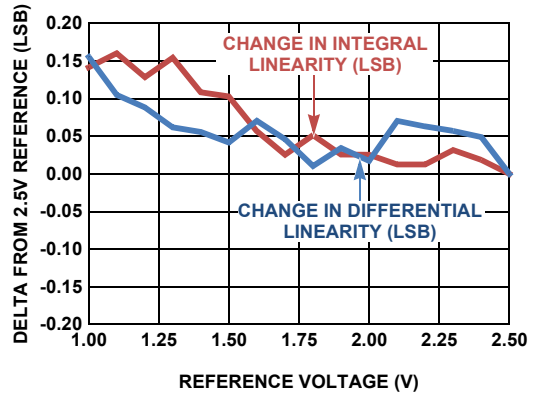

FIGURE 19. CHANGE IN INTEGRAL LINEARITY AND DIFFERENTIAL LINEARITY vs REFERENCE VOLTAGE

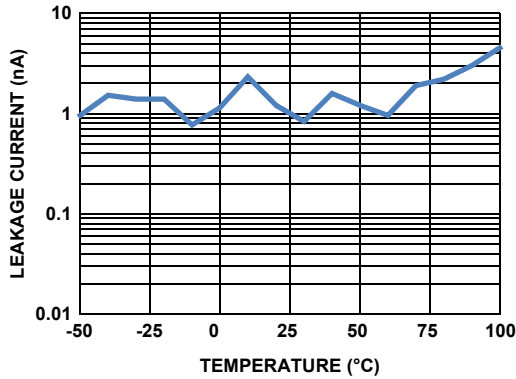

FIGURE 20. INPUT LEAKAGE CURRENT vs TEMPERATURE

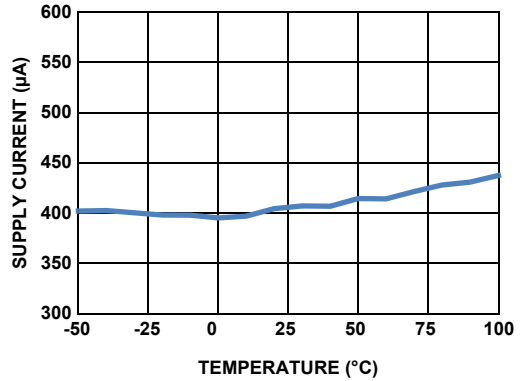

FIGURE 21. SUPPLY CURRENT vs TEMPERATURE

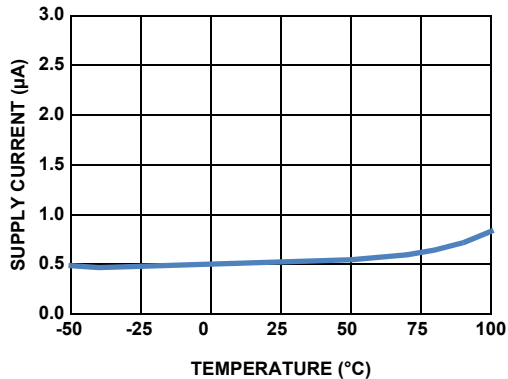

FIGURE 22. POWER DOWN SUPPLY CURRENT vs TEMPERATURE

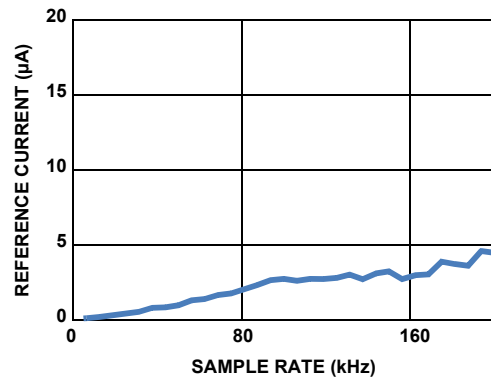

FIGURE 23. REFERENCE CURRENT vs SAMPLE RATE (CODE = FF8h)

## Typical Performance Characteristics

$T_A = +25^\circ\text{C}$ ,  $V_{CC} = 5\text{V}$ ,  $V_{REF} = 2.5\text{V}$ ,  $f_{\text{SAMPLE}} = 200\text{kHz}$ ,  
 $f_{\text{CLK}} = 16 * f_{\text{SAMPLE}}$ , unless otherwise specified. (Continued)

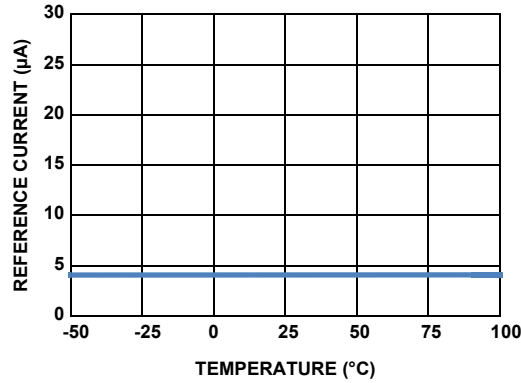

FIGURE 24. REFERENCE CURRENT vs TEMPERATURE (CODE = FF8h)

## Functional Description

The ISL267817 is based on a successive approximation register (SAR) architecture utilizing capacitive charge redistribution digital to analog converters (DACs). Figure 25 shows a simplified representation of the converter. During the acquisition phase (ACQ), the differential input is stored on the sampling capacitors (CS). The comparator is in a balanced state since the switch across its inputs is closed. The signal is fully acquired after  $t_{\text{ACQ}}$  has elapsed, and the switches then transition to the conversion phase (CONV) so the stored voltage may be converted to digital format. The comparator will become unbalanced when the differential switch opens and the input switches transition (assuming that the stored voltage is not exactly at mid-scale). The comparator output reflects whether the stored voltage is above or below mid-scale, which sets the value of the MSB. The SAR logic then forces the capacitive DACs to adjust up or down by one quarter of full-scale by switching in binarily weighted capacitors. Again, the comparator output reflects whether the stored voltage is above or below the new value, setting the value of the next lowest bit. This process repeats until all 12 bits have been resolved.

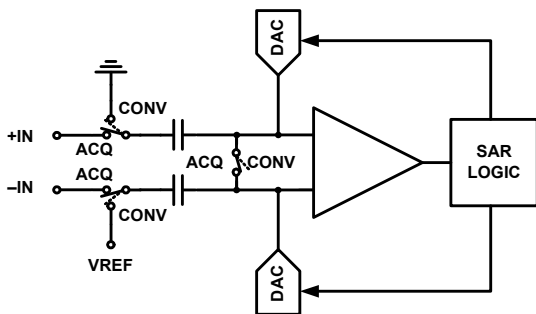

FIGURE 25. SAR ADC ARCHITECTURAL BLOCK DIAGRAM

An external clock must be applied to the DCLOCK pin to generate a conversion result. The allowable frequency range for DCLOCK is 10kHz to 3.2MHz (625SPS to 200kSPS). Serial output data is transmitted on the falling edge of DCLOCK. The receiving device (FPGA, DSP or Microcontroller) may latch the data on the rising edge of DCLOCK to maximize set-up and hold times.

A stable, low-noise reference voltage must be applied to the VREF pin to set the full-scale input range and common-mode voltage. See “Voltage Reference Input” on page 12 for more details.

## ADC Transfer Function

The output coding for the ISL267817 is twos complement. The first code transition occurs at successive LSB values (i.e., 1 LSB, 2 LSB, and so on). The LSB size is  $2 * V_{REF} / 4096$ . The ideal transfer characteristic of the ISL267817 is shown in Figure 26.

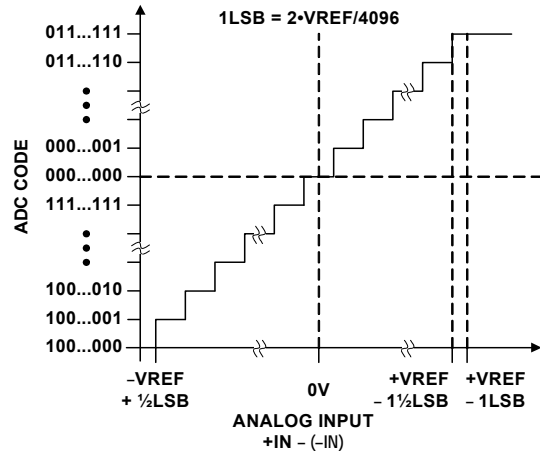

FIGURE 26. IDEAL TRANSFER CHARACTERISTICS

## Analog Input

The ISL267817 features a fully differential input with a nominal full-scale range equal to twice the applied VREF voltage. Each input swings  $V_{REF} V_{P,P}$ ,  $180^\circ$  out-of-phase from one another for a total differential input of  $2 * V_{REF}$  (refer to Figure 27).

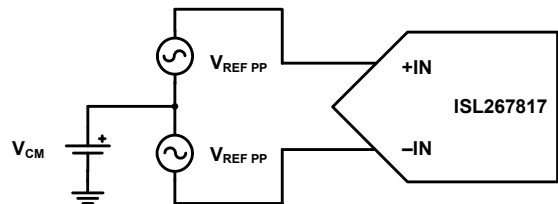

FIGURE 27. DIFFERENTIAL INPUT SIGNALING

Differential signaling offers several benefits over a single-ended input, such as:

- Doubling of the full-scale input range (and therefore the dynamic range)
- Improved even order harmonic distortion
- Better noise immunity due to common mode rejection

Figure 28 shows the relationship between the reference voltage and the full-scale input range for two different values of VREF. Note that there is a trade-off between VREF and the allowable common mode input voltage (VCM). The full-scale input range is proportional to VREF; therefore the VCM range must be limited for larger values of VREF in order to keep the absolute maximum and minimum voltages on the +IN and -IN pins within specification. Figures 29 and 30 illustrate this relationship for single-ended and differential inputs, respectively.

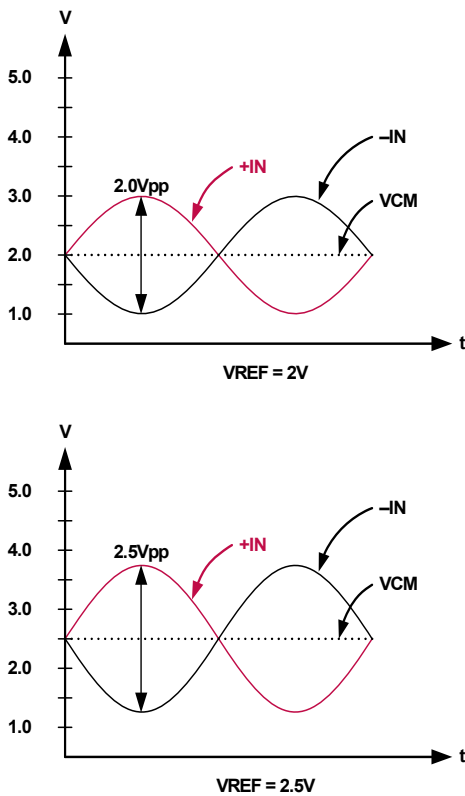

FIGURE 28. RELATIONSHIP BETWEEN VREF AND FULL-SCALE RANGE

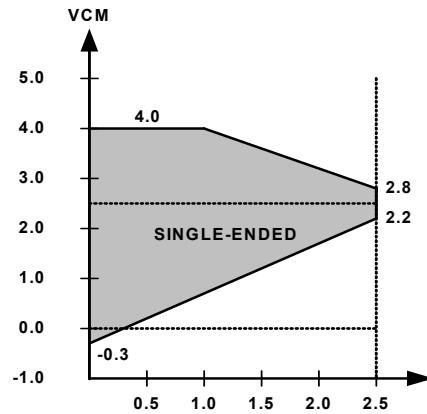

FIGURE 29. RELATIONSHIP BETWEEN VREF AND VCM FOR SINGLE-ENDED INPUTS (+VCC = 5V)

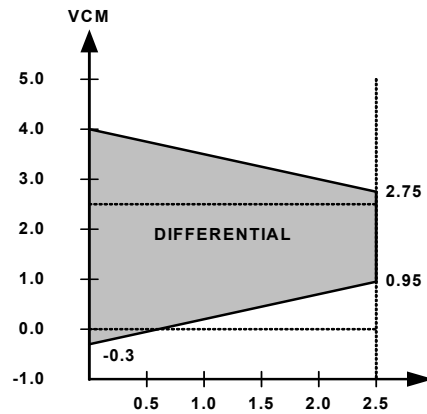

FIGURE 30. RELATIONSHIP BETWEEN VREF AND VCM FOR DIFFERENTIAL INPUTS (+VCC = 5V)

### Voltage Reference Input

An external low-noise reference voltage must be applied to the VREF pin to set the full-scale input range of the converter. The reference input accepts voltages ranging from 0.1V to 2.5V; however the device is specified with a reference voltage of 2.5V.

Figures 31 and 32 illustrate possible voltage reference options for the ISL267817. Figure 31 uses the precision ISL21090 voltage reference which exhibits exceptionally low drift and low noise. The VREF input pin of the ISL267817 devices uses very low current, so the decoupling capacitor can be small (0.1μF).

Figure 32 illustrates the ISL21010 voltage reference being used with these ADCs. The ISL21010 series voltage references have higher noise and drift than the ISL26090 devices, but they consume very low operating current and are excellent for battery-powered applications.

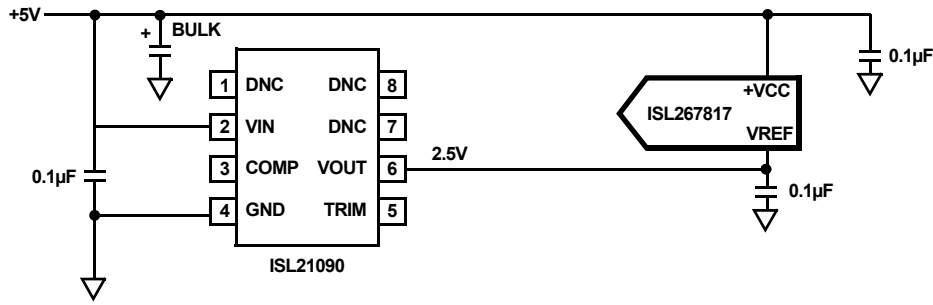

FIGURE 31. PRECISION VOLTAGE REFERENCE

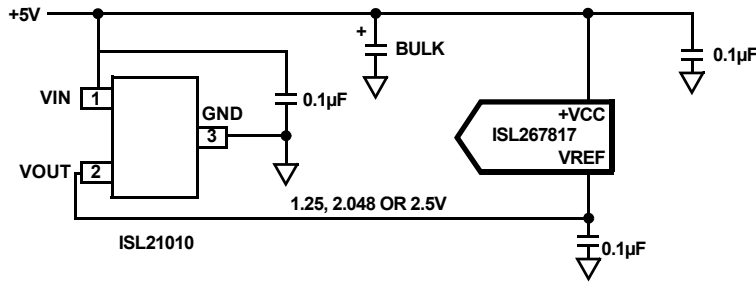

FIGURE 32. LOWER COST VOLTAGE REFERENCE

**POWER-DOWN/STANDBY MODES**

The mode of operation of the ISL267817 is selected by controlling the logic state of the  $\overline{CS}/SHDN$  signal during a conversion. There are two possible modes of operation: dynamic mode or static mode. When  $\overline{CS}/SHDN$  is high (deasserted), the ADC will be in static mode. Conversely, when  $\overline{CS}/SHDN$  is low (asserted), the device will be in dynamic mode. There are no minimum or maximum number of DCLOCK cycles required to enter static mode, which simplifies power management and allows the user to easily optimize power dissipation versus throughput for different application requirements.

**DYNAMIC MODE**

This mode is entered when a conversion result is desired by asserting  $\overline{CS}/SHDN$ . Figure 33 shows the general diagram of operation in this mode. The conversion is initiated on the falling edge of  $\overline{CS}/SHDN$ , as described in the “Serial Digital Interface” section on page 14. As soon as  $\overline{CS}/SHDN$  is brought high, the conversion will be terminated and DOUT will go back into three-state. Sixteen serial clock cycles are required to complete the conversion and access the complete conversion result.  $\overline{CS}/SHDN$  may idle high until the next conversion or idle low until sometime prior to the next conversion. Once a data transfer is complete, i.e., when DOUT has returned to three-state, another conversion can be initiated by again bringing  $\overline{CS}/SHDN$  low.

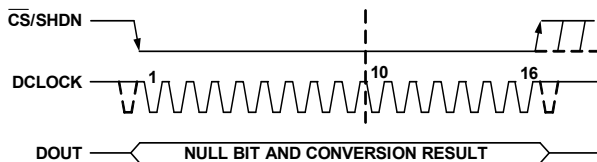

FIGURE 33. NORMAL MODE OPERATION

**STATIC MODE**

The ISL267817 enters the power-saving static mode automatically any time  $\overline{CS}/SHDN$  is deasserted. It is not required that the user force a device into this mode following a conversion in order to optimize power consumption.

**SHORT CYCLING**

In cases where a lower resolution conversion is acceptable,  $\overline{CS}/SHDN$  can be pulled high before 12 DCLOCK falling edges have elapsed. This is referred to as short cycling, and it can be used to further optimize power dissipation. In this mode, a lower resolution result will be acquired, but the ADC will enter static mode sooner and exhibit a lower average power dissipation than if the complete conversion cycle were carried out. The acquisition time ( $t_{ACQ}$ ) requirement must be met for the next conversion to be valid.

**POWER-ON RESET**

The ISL267817 performs a power-on reset when the supplies are first activated, which requires approximately 2.5ms to execute. After this is complete, a single dummy cycle must be executed in order to initialize the switched capacitor track and hold. A dummy cycle will take 5µs with an 3.2MHz DCLOCK. Once the dummy cycle is complete, the ADC mode will be determined by the state of  $\overline{CS}/SHDN$ . At this point, switching between dynamic and static modes is controlled by  $\overline{CS}/SHDN$  with no delay required between states.

**POWER vs THROUGHPUT RATE**

The ISL267817 provides reduced power consumption at lower conversion rates by automatically switching into a low-power mode after completing a conversion. Maximum power savings are achieved by running SCLK at the maximum rate, as shown in Figure 34. If SCLK is operated at a fixed 16x multiple of the

sample rate then the average power consumption of the ADC is roughly constant, decreasing somewhat at lower throughput rates (Figure 35).

The shutdown current is impacted by the state of the  $\overline{CS}/\text{SHDN}$  pin, as shown in Figure 36.

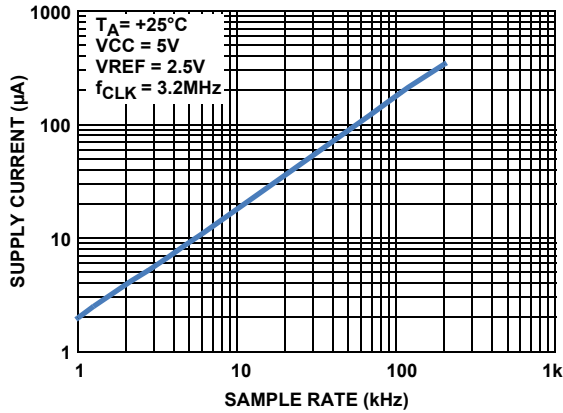

FIGURE 34. POWER CONSUMPTION vs SAMPLE RATE,  $f_{\text{CLK}} = 3.2\text{MHz}$

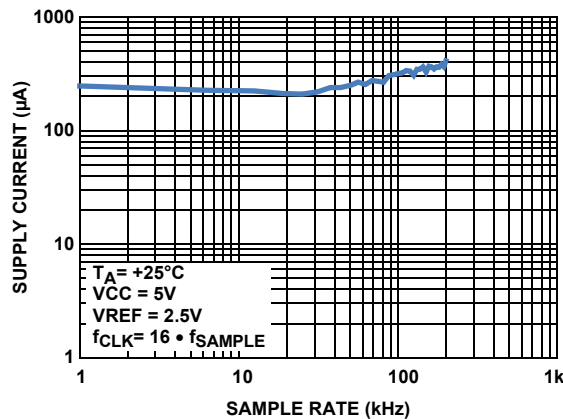

FIGURE 35. SHUTDOWN CURRENT vs SAMPLE RATE,  $f_{\text{CLK}} = 16 \cdot f_{\text{SAMPLE}}$

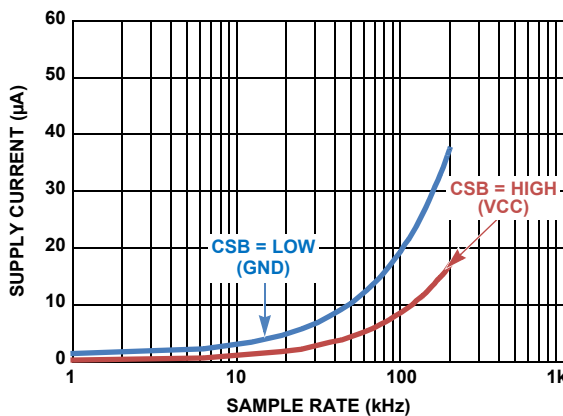

FIGURE 36. SHUTDOWN CURRENT vs SAMPLE RATE

## Serial Digital Interface

Conversion data is accessed with an SPI-compatible serial interface. The interface consists of the data clock (DCLOCK), serial data output (DOUT), and chip select/shutdown ( $\overline{CS}/\text{SHDN}$ ).

A falling edge on the  $\overline{CS}/\text{SHDN}$  signal initiates a conversion by placing the part into the acquisition (ACQ) phase. After  $t_{\text{ACQ}}$  has elapsed, the part enters the conversion (CONV) phase and begins outputting the conversion result starting with a null bit followed by the most significant bit (MSB) and ending with the least significant bit (LSB). The  $\overline{CS}/\text{SHDN}$  pin can be pulled high at this point to put the device into Standby mode and reduce the power consumption. If  $\overline{CS}/\text{SHDN}$  is held low after the LSB bit has been output, the conversion result will be repeated in reverse order until the MSB is transmitted, after which the serial output enters a high impedance state. The ISL267817 will remain in this state, dissipating typical dynamic power levels, until  $\overline{CS}/\text{SHDN}$  transitions high then low to initiate the next conversion.

## Data Format

Output data is encoded in two's complement format, as shown in Table 1. The voltage levels in the table are idealized and don't account for any gain/offset errors or noise.

TABLE 1. TWO'S COMPLEMENT DATA FORMATTING

INPUT	VOLTAGE	DIGITAL OUTPUT
-Full Scale	-VREF	1000 0000 0000
-Full Scale + 1LSB	-VREF + ½ LSB	1000 0000 0001
Midscale	0	0000 0000 0000
+Full Scale - 1LSB	+VREF - 1½ LSB	0111 1111 1110
+Full Scale	+VREF - ½ LSB	0111 1111 1111

## TERMINOLOGY

### Signal-to-(Noise + Distortion) Ratio (SINAD)

This is the measured ratio of signal-to-(noise + distortion) at the output of the ADC. The signal is the RMS amplitude of the fundamental. Noise is the sum of all non-fundamental signals up to half the sampling frequency ( $f_s/2$ ), excluding DC. The ratio is dependent on the number of quantization levels in the digitization process; the more levels, the smaller the quantization noise. The theoretical signal-to-(noise + distortion) ratio for an ideal N-bit converter with a sine wave input is given by Equation 1:

$$\text{Signal-to-(Noise + Distortion)} = (6.02 N + 1.76)\text{dB} \quad (\text{EQ. 1})$$

Thus, for a 12-bit converter this is 74dB, and for a 10-bit this is 62dB.

### Total Harmonic Distortion

Total harmonic distortion (THD) is the ratio of the RMS sum of harmonics to the fundamental. For the ISL267817, it is defined as Equation 2:

$$\text{THD(dB)} = 20\log \frac{\sqrt{V_2^2 + V_3^2 + V_4^2 + V_5^2 + V_6^2}}{V_1^2} \quad (\text{EQ. 2})$$

where  $V_1$  is the RMS amplitude of the fundamental and  $V_2$ ,  $V_3$ ,  $V_4$ ,  $V_5$ , and  $V_6$  are the RMS amplitudes of the second to the sixth harmonics.

#### Peak Harmonic or Spurious Noise (SFDR)

Peak harmonic or spurious noise is defined as the ratio of the RMS value of the next largest component in the ADC output spectrum (up to  $f_s/2$  and excluding DC) to the RMS value of the fundamental. Also referred to as Spurious Free Dynamic Range (SFDR). Normally, the value of this specification is determined by the largest harmonic in the spectrum, but for ADCs where the harmonics are buried in the noise floor, it will be a noise peak.

#### Full Power Bandwidth

The full power bandwidth of an ADC is that input frequency at which the amplitude of the reconstructed fundamental is reduced by 3dB for a full-scale input.

#### Common-Mode Rejection Ratio (CMRR)

The common-mode rejection ratio is defined as the ratio of the power in the ADC output at full-scale frequency,  $f$ , to the power of a 250mV<sub>P-P</sub> sine wave applied to the common-mode voltage of +IN and -IN of frequency  $f_s$ :

$$\text{CMRR(dB)} = 10\log(P_f/P_{f_s}) \quad (\text{EQ. 3})$$

$P_f$  is the power at the frequency  $f$  in the ADC output;  $P_{f_s}$  is the power at frequency  $f_s$  in the ADC output.

#### Integral Nonlinearity (INL)

This is the maximum deviation from a straight line passing through the endpoints of the ADC transfer function.

#### Differential Nonlinearity (DNL)

This is the difference between the measured and the ideal 1 LSB change between any two adjacent codes in the ADC.

#### Zero-Code Error

This is the deviation of the midscale code transition (111...111 to 000...000) from the ideal +IN - (-IN) (i.e., 0 LSB).

#### Gain Error

This is the deviation of the first code transition (100...000 to 100...001) from the ideal +IN - (-IN) (i.e., -VREF + ½ LSB) or the last code transition (011...110 to 011...111) from the ideal +IN - (-IN) (i.e., +VREF - 1½ LSB), after the zero code error has been adjusted out.

#### Track and Hold Acquisition Time

The track and hold acquisition time is the minimum time required for the track and hold amplifier to remain in track mode for its output to reach and settle to within 0.5 LSB of the applied input signal.

#### Power Supply Rejection Ratio (PSRR)

The power supply rejection ratio is defined as the ratio of the power in the ADC output at full-scale frequency,  $f$ , to ADC +VCC supply of frequency  $f_s$ . The frequency of this input varies from 1kHz to 1MHz.

$$\text{PSRR(dB)} = 10\log(P_f/P_{f_s}) \quad (\text{EQ. 4})$$

$P_f$  is the power at frequency  $f$  in the ADC output;  $P_{f_s}$  is the power at frequency  $f_s$  in the ADC output.

## Application Hints

### Grounding and Layout

The printed circuit board that houses the ISL267817 should be designed so that the analog and digital sections are separated and confined to certain areas of the board. This facilitates the use of ground planes that can be easily separated. A minimum etch technique is generally best for ground planes since it gives the best shielding. Digital and analog ground planes should be joined in only one place, and the connection should be a star ground point established as close to the GND pin on the ISL267817 as possible. Avoid running digital lines under the device, as this will couple noise onto the die. The analog ground plane should be allowed to run under the ISL267817 to avoid noise coupling.

The power supply lines to the device should use as large a trace as possible to provide low impedance paths and reduce the effects of glitches on the power supply line.

Fast switching signals, such as clocks, should be shielded with digital ground to avoid radiating noise to other sections of the board, and clock signals should never run near the analog inputs. Avoid crossover of digital and analog signals. Traces on opposite sides of the board should run at right angles to each other. This reduces the effects of feedthrough through the board. A microstrip technique is by far the best but is not always possible with a double-sided board.

In this technique, the component side of the board is dedicated to ground planes, while signals are placed on the solder side.

Good decoupling is also important. All analog supplies should be decoupled with 10µF tantalum capacitors in parallel with 0.1µF capacitors to GND. To achieve the best from these decoupling components, they must be placed as close as possible to the device.



## Revision History

The revision history provided is for informational purposes only and is believed to be accurate, but not warranted. Please go to web to make sure you have the latest revision.

DATE	REVISION	CHANGE
March 19, 2012	FN7877.2	Renamed in Figure 1 pin names to match package pinout names Electrical Spec Table Reference Input on page 5 changed "REF" to "VREF" Modified text in Figures 31 and 32 by renaming Figure titles from "Precision Voltage Reference for +5V Supply" to "Precision Voltage Reference" and "Voltage Reference for +2.7V to +3.6V or for +5V" to "Lower Cost Voltage Reference", Changed pin names VDD to +VCC, Removed +2.7V to +3.5V and leaving +5V in Figure 32 Removed "+" from VREF capacitor in "Typical Connection Diagram" on page 2. Replaced last sentence of 1st paragraph, 2nd paragraph and graphic in "Voltage Reference Input" on page 12. Removed "Applications Information" section M8.15 - Updated to latest revision - Changed Note 1 "1982" to "1994"
December 14, 2011	FN7877.1	Pg 1, Added mention of MSOP package to last paragraph of description and last Features bullet. Pg 2, Removed "Coming Soon" for ISL267817IUZ package in Ordering Information table. Changed "(8 LD SOIC)" to "(8 LD SOIC, MSOP)" in the Pin Configuration Pg 18, Inserted latest M8.118 POD at the end of the document
October 28, 2011	FN7877.0	Initial Release

## Products

Intersil Corporation is a leader in the design and manufacture of high-performance analog semiconductors. The Company's products address some of the industry's fastest growing markets, such as, flat panel displays, cell phones, handheld products, and notebooks. Intersil's product families address power management and analog signal processing functions. Go to [www.intersil.com/products](http://www.intersil.com/products) for a complete list of Intersil product families.

For a complete listing of Applications, Related Documentation and Related Parts, please see the respective device information page on intersil.com: [ISL267817](http://www.intersil.com/ISL267817)

To report errors or suggestions for this datasheet, please go to: [www.intersil.com/askourstaff](http://www.intersil.com/askourstaff)

FITs are available from our website at: <http://rel.intersil.com/reports/search.php>

© Copyright Intersil Americas LLC 2011-2012. All Rights Reserved.  
All trademarks and registered trademarks are the property of their respective owners.

For additional products, see [www.intersil.com/en/products.html](http://www.intersil.com/en/products.html)

Intersil products are manufactured, assembled and tested utilizing ISO9001 quality systems as noted in the quality certifications found at [www.intersil.com/en/support/qualandreliability.html](http://www.intersil.com/en/support/qualandreliability.html)

*Intersil products are sold by description only. Intersil may modify the circuit design and/or specifications of products at any time without notice, provided that such modification does not, in Intersil's sole judgment, affect the form, fit or function of the product. Accordingly, the reader is cautioned to verify that datasheets are current before placing orders. Information furnished by Intersil is believed to be accurate and reliable. However, no responsibility is assumed by Intersil or its subsidiaries for its use; nor for any infringements of patents or other rights of third parties which may result from its use. No license is granted by implication or otherwise under any patent or patent rights of Intersil or its subsidiaries.*

For information regarding Intersil Corporation and its products, see [www.intersil.com](http://www.intersil.com)



# Package Outline Drawing

## M8.15

8 LEAD NARROW BODY SMALL OUTLINE PLASTIC PACKAGE

Rev 4, 1/12

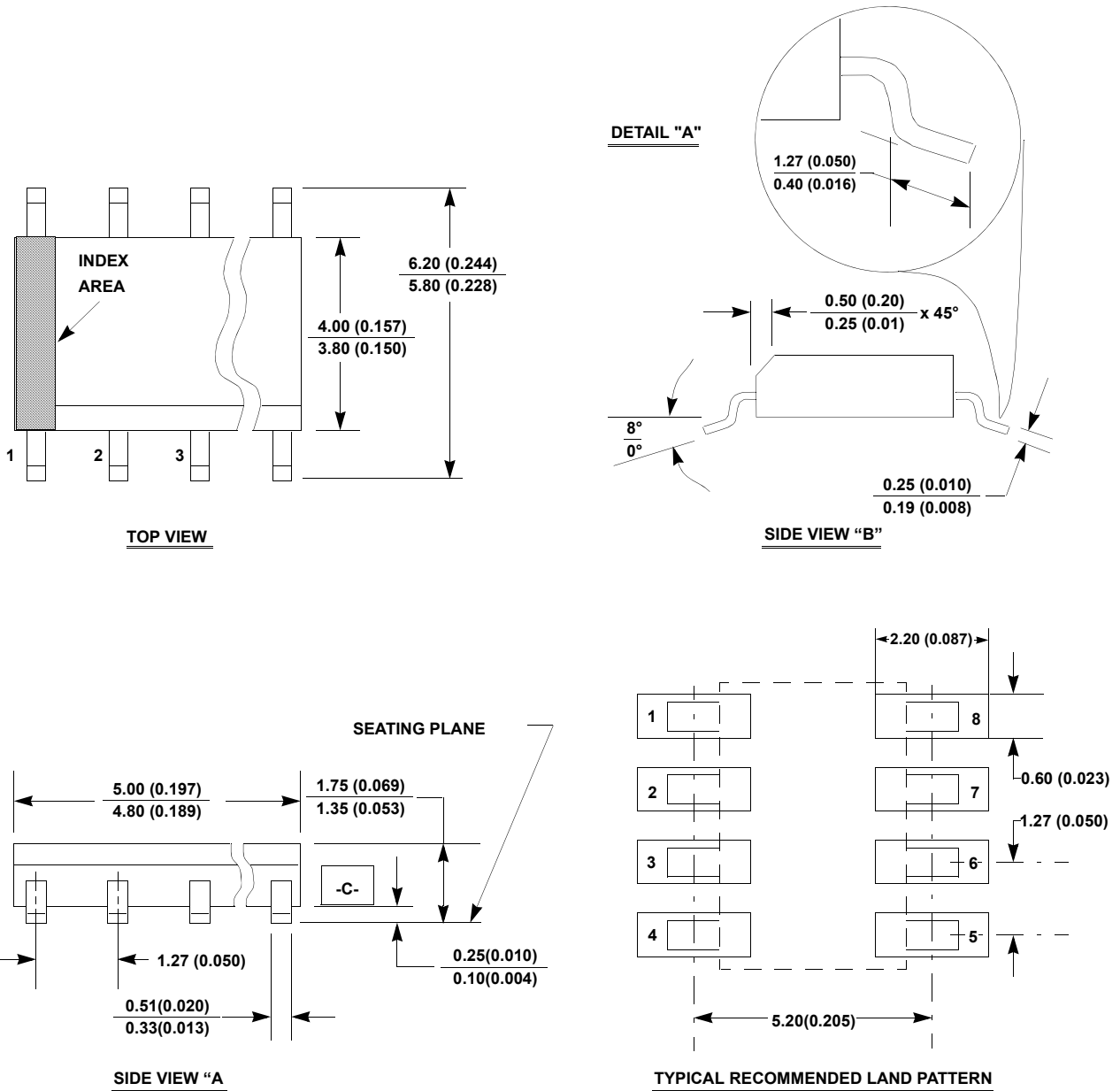

**NOTES:**

1. Dimensioning and tolerancing per ANSI Y14.5M-1994.
2. Package length does not include mold flash, protrusions or gate burrs. Mold flash, protrusion and gate burrs shall not exceed 0.15mm (0.006 inch) per side.
3. Package width does not include interlead flash or protrusions. Interlead flash and protrusions shall not exceed 0.25mm (0.010 inch) per side.
4. The chamfer on the body is optional. If it is not present, a visual index feature must be located within the crosshatched area.
5. Terminal numbers are shown for reference only.
6. The lead width as measured 0.36mm (0.014 inch) or greater above the seating plane, shall not exceed a maximum value of 0.61mm (0.024 inch).
7. Controlling dimension: MILLIMETER. Converted inch dimensions are not necessarily exact.
8. This outline conforms to JEDEC publication MS-012-AA ISSUE C.

# Package Outline Drawing

## M8.118

8 LEAD MINI SMALL OUTLINE PLASTIC PACKAGE

Rev 4, 7/11

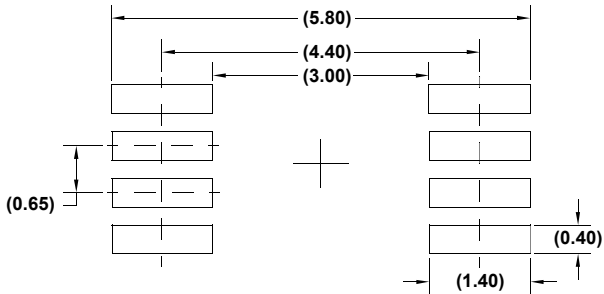
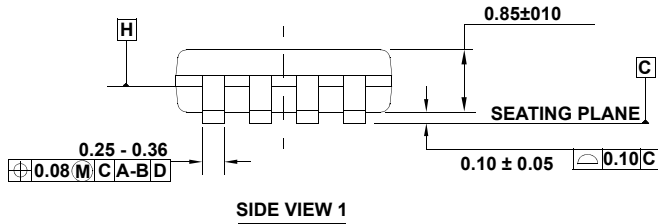
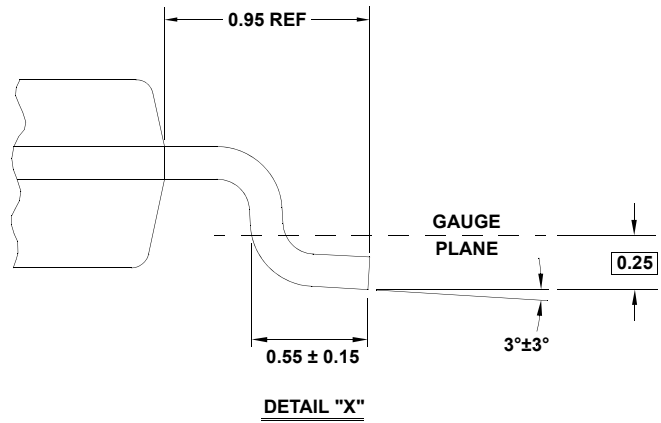
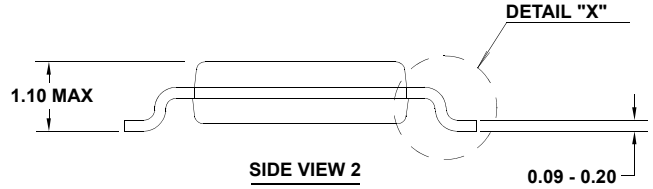
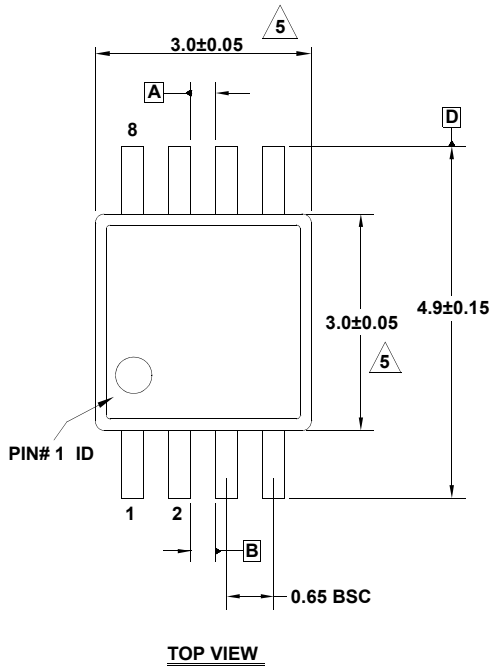

**NOTES:**

1. Dimensions are in millimeters.
2. Dimensioning and tolerancing conform to JEDEC MO-187-AA and AMSEY14.5m-1994.
3. Plastic or metal protrusions of 0.15mm max per side are not included.
4. Plastic interlead protrusions of 0.15mm max per side are not included.
5. Dimensions are measured at Datum Plane "H".
6. Dimensions in ( ) are for reference only.

## X-ON Electronics

Largest Supplier of Electrical and Electronic Components

*Click to view similar products for [Analog to Digital Converters - ADC category](#):*

*Click to view products by [Renesas manufacturer](#):*

Other Similar products are found below :

[017539FB](#) [020296DB](#) [AD7916BRMZ-RL7](#) [AD9257TCPZ-65-EP](#) [ADC0804LCD](#) [ADC0808](#) [512761G](#) [AD9695BCPZ-625](#)  
[MAX15511TGTL+](#) [MAX1111EEE/V+](#) [AD7175-8BCPZ-RL7](#) [MAX1436BECQ+D](#) [MAX16924GGM/VY+](#) [MAX11108AVB+T](#)  
[MAX11647EUA+T](#) [MCP33141-10T-E/MS](#) [MCP33141D-05T-E/MS](#) [MCP33151D-05T-E/MS](#) [MAX11210EEE+T](#) [MCP3202T-CI/MS](#)  
[MAX11137ATI+T](#) [MAX11136ATI+T](#) [MAX11612EUA+T](#) [MAX11212AEUB+T](#) [MAX11101EUB+T](#) [MAX14002AAP+T](#) [MCP33141-05T-](#)  
[E/MS](#) [NCD98010XMXTAG](#) [MAX11636EEE+T](#) [MCP33141D-10T-E/MS](#) [MCP33151-05T-E/MS](#) [MCP33151-10T-E/MS](#) [MCP33151D-10T-](#)  
[E/MS](#) [MAX11259AWX+T](#) [AD7091R-5BRUZ-RL7](#) [ADE1201ACCZ](#) [ADE1202ACCZ](#) [AD9094-1000EBZ](#) [THS1408IPFB](#) [TLC0820ACN](#)  
[TLC2543IN](#) [TLV2543IDW](#) [ISL267450IBZ-T7A](#) [ISL267440IHZ-T7A](#) [ISL26708IHZ-T7A](#) [ADS5231IPAG](#) [ADS7807U](#) [ADS7890IPFBT](#)  
[ADS7891IPFBT](#) [ADS7950QDBTRQ1](#)