

## ISL28236

5MHz, Dual Precision Rail-to-Rail Input-Output (RRIO) Op Amps

FN6921  
Rev 2.00  
July 24, 2014

The ISL28236 is a low-power dual operational amplifier optimized for single supply operation from 2.4V to 5.5V, allowing operation from one lithium cell or two Ni-Cd batteries. The device features a gain-bandwidth product of 5MHz.

The ISL28236 features an Input Range Enhancement Circuit (IREC), which enables the amplifier to maintain CMRR performance for input voltages greater than the positive supply. The input signal is capable of swinging 0.25V above the positive supply and to the negative supply with only a slight degradation of the CMRR performance. The output operation is rail-to-rail.

The part typically draws less than 1mA supply current per amplifier while meeting excellent DC accuracy, AC performance, noise and output drive specifications. The ISL28236 is available in the 8 Ld SOIC and the 8 Ld MSOP. Operation is guaranteed over the -40°C to +125°C temperature range.

### Ordering Information

PART NUMBER (Notes 2, 3)	PART MARKING	PACKAGE (Pb-Free)	PKG. DWG. #
ISL28236FBZ	28236 FBZ	8 Ld SOIC	M8.15E
ISL28236FBZ-T7 (Note 1)	28236 FBZ	8 Ld SOIC	M8.15E
ISL28236FBZ-T7A (Note 1)	28236 FBZ	8 Ld SOIC	M8.15E
ISL28236FUZ	8236Z	8 Ld MSOP	M8.118A
ISL28236FUZ-T7 (Note 1)	8236Z	8 Ld MSOP	M8.118A
ISL28236FUZ-T7A (Note 1)	8236Z	8 Ld MSOP	M8.118A
ISL28236SOICEVAL1Z	Evaluation Board		

#### NOTES:

1. Please refer to [TB347](#) for details on reel specifications.
2. These Intersil Pb-free plastic packaged products employ special Pb-free material sets, molding compounds/die attach materials, and 100% matte tin plate plus anneal (e3 termination finish, which is RoHS compliant and compatible with both SnPb and Pb-free soldering operations). Intersil Pb-free products are MSL classified at Pb-free peak reflow temperatures that meet or exceed the Pb-free requirements of IPC/JEDEC J STD-020.
3. For Moisture Sensitivity Level (MSL), please see product information page for [ISL28236](#). For more information on MSL, please see tech brief [TB363](#).

### Features

- 5MHz gain bandwidth product at  $A_V = 100$
- 2mA typical supply current
- 240 $\mu$ V maximum offset voltage (SOIC package)
- 6nA typical input bias current (SOIC package)
- Down to 2.4V single supply voltage range
- Rail-to-rail input and output
- -40°C to +125°C operation
- Pb-Free (RoHS compliant)

### Applications

- Low-end audio
- 4mA to 20mA current loops
- Medical devices
- Sensor amplifiers
- ADC Buffers
- DAC output amplifiers

### Related Literature

- [AN1420](#), "ISL282x6EVAL1Z Evaluation Board User's Guide"

# Pin Configurations

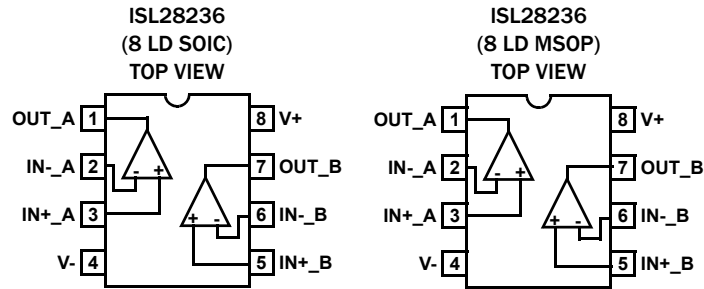

# Pin Descriptions

ISL28236 (8 Ld SOIC)	ISL28236 (8 Ld MSOP)	PIN NAME	FUNCTION	EQUIVALENT CIRCUIT
2	2	IN-_A	Inverting input	<p>Circuit 1</p>
6	6	IN-_B		
3	3	IN+_A	Non-inverting input	See Circuit 1
5	5	IN+_B		
4	4	V-	Negative supply	<p>Circuit 2</p>
1	1	OUT_A	Output	<p>Circuit 3</p>
7	7	OUT_B		
8	8	V+	Positive supply	See Circuit 2

**Absolute Maximum Ratings** ( $T_A = +25^\circ\text{C}$ )

Supply Voltage	5.75V
Supply Turn-on Voltage Slew Rate	1V/ $\mu\text{s}$
Differential Input Current	5mA
Differential Input Voltage	0.5V
Input Voltage	V <sub>-</sub> -0.5V to V <sub>+</sub> + 0.5V
ESD Rating	
Human Body Model	3kV
Machine Model	300V

**Thermal Information**

Thermal Resistance (Typical <a href="#">Notes 4, 5</a> )	$\theta_{JA}$ ( $^\circ\text{C}/\text{W}$ )	$\theta_{JC}$ ( $^\circ\text{C}/\text{W}$ )
8 Ld SOIC Package	120	60
8 Ld MSOP Package	160	55
Storage Temperature Range	-65 $^\circ\text{C}$ to +150 $^\circ\text{C}$	
Pb-Free Reflow Profile	see <a href="#">TB493</a>	

**Operating Conditions**

Ambient Temperature Range	-40 $^\circ\text{C}$ to +125 $^\circ\text{C}$
Junction Temperature	+125 $^\circ\text{C}$

**CAUTION:** Do not operate at or near the maximum ratings listed for extended periods of time. Exposure to such conditions may adversely impact product reliability and result in failures not covered by warranty.

**NOTES:**

- $\theta_{JA}$  is measured with the component mounted on a high effective thermal conductivity test board in free air. See Tech Brief [TB379](#) for details.
- For  $\theta_{JC}$ , the "case temp" location is taken at the package top center.

**IMPORTANT NOTE:** All parameters having Min/Max specifications are guaranteed. Typical values are for information purposes only. Unless otherwise noted, all tests are at the specified temperature and are pulsed tests, therefore:  $T_J = T_C = T_A$

**Electrical Specifications**  $V_+ = 5\text{V}$ ,  $V_- = 0\text{V}$ ,  $V_{CM} = 2.5\text{V}$ ,  $R_L = \text{Open}$ ,  $T_A = +25^\circ\text{C}$  unless otherwise specified. **Boldface limits apply across the operating temperature range, -40 $^\circ\text{C}$  to +125 $^\circ\text{C}$ .** Temperature data established by characterization.

PARAMETER	DESCRIPTION	TEST CONDITIONS	MIN ( <a href="#">Note 6</a> )	TYP	MAX ( <a href="#">Note 6</a> )	UNITS
<b>DC SPECIFICATIONS</b>						
$V_{OS}$	Input Offset Voltage	8 Ld SOIC	-240 <b>-250</b>	20	240 <b>250</b>	$\mu\text{V}$
		8 Ld MSOP	-270 <b>-530</b>	20	270 <b>530</b>	$\mu\text{V}$
$\frac{\Delta V_{OS}}{\Delta T}$	Input Offset Voltage vs Temperature			0.4		$\mu\text{V}/^\circ\text{C}$
$I_{OS}$	Input Offset Current	8 Ld SOIC $T_A = -40^\circ\text{C}$ to +125 $^\circ\text{C}$	-10 <b>-30</b>	2	10 <b>30</b>	nA
		8 Ld MSOP $T_A = -40^\circ\text{C}$ to +125 $^\circ\text{C}$	-23 <b>-50</b>	2	23 <b>50</b>	nA
$I_B$	Input Bias Current	8 Ld SOIC $T_A = -40^\circ\text{C}$ to +125 $^\circ\text{C}$	-40 <b>-50</b>	6	40 <b>50</b>	nA
		8 Ld MSOP $T_A = -40^\circ\text{C}$ to +125 $^\circ\text{C}$	-50 <b>-70</b>	6	50 <b>70</b>	nA
$V_{CM}$	Common-Mode Voltage Range	Guaranteed by CMRR	0		5	V
CMRR	Common-Mode Rejection Ratio	$V_{CM} = 0\text{V}$ to 5V	90 <b>90</b>	115		dB
PSRR	Power Supply Rejection Ratio	$V_+ = 2.4\text{V}$ to 5.5V	90 <b>90</b>	100		dB
$A_{VOL}$	Large Signal Voltage Gain	8 Ld SOIC $V_O = 0.5\text{V}$ to 4V, $R_L = 100\text{k}\Omega$ to $V_{CM}$	600 <b>500</b>	1600		V/mV
		8 Ld MSOP $V_O = 0.5\text{V}$ to 4V, $R_L = 100\text{k}\Omega$ to $V_{CM}$	600 <b>400</b>	1600		V/mV
		$V_O = 0.5\text{V}$ to 4V, $R_L = 1\text{k}\Omega$ to $V_{CM}$		100		V/mV

**Electrical Specifications**  $V_+ = 5V$ ,  $V_- = 0V$ ,  $V_{CM} = 2.5V$ ,  $R_L = \text{Open}$ ,  $T_A = +25^\circ\text{C}$  unless otherwise specified. **Boldface limits apply across the operating temperature range,  $-40^\circ\text{C}$  to  $+125^\circ\text{C}$ .** Temperature data established by characterization. (Continued)

PARAMETER	DESCRIPTION	TEST CONDITIONS	MIN (Note 6)	TYP	MAX (Note 6)	UNITS
V <sub>OUT</sub>	Maximum Output Voltage Swing	Output low, $R_L = 100k\Omega$ to $V_{CM}$		1	<b>10</b> <b>10</b>	mV
		Output low, $R_L = 1k\Omega$ to $V_{CM}$		47	<b>70</b> <b>90</b>	mV
		Output high, $R_L = 100k\Omega$ to $V_{CM}$	4.99 <b>4.99</b>	4.997		V
		Output high, $R_L = 1k\Omega$ to $V_{CM}$	4.93 <b>4.91</b>	4.952		V
I <sub>S</sub>	Supply Current			2	2.5 <b>2.6</b>	mA
I <sub>O+</sub>	Short-Circuit Output Source Current	$R_L = 10\Omega$ to $V_{CM}$	50 <b>40</b>	70		mA
I <sub>O-</sub>	Short-Circuit Output Sink Current	$R_L = 10\Omega$ to $V_{CM}$	50 <b>40</b>	70		mA
V <sub>SUPPLY</sub>	Supply Operating Range	$V_+$ to $V_-$	2.4		5.5	V
<b>AC SPECIFICATIONS</b>						
GBW	Gain Bandwidth Product	$A_V = 100$ , $R_F = 100k\Omega$ , $R_G = R_L = 10k\Omega$ to $V_{CM}$		5		MHz
e <sub>N</sub>	Input Noise Voltage Peak-to-Peak	$f = 0.1\text{Hz}$ to $10\text{Hz}$ , $R_L = 10k\Omega$ to $V_{CM}$		0.4		$\mu\text{V}_{P-P}$
	Input Noise Voltage Density	$f_0 = 1\text{kHz}$ , $R_L = 10k\Omega$ to $V_{CM}$		15		$\text{nV}/\sqrt{\text{Hz}}$
i <sub>N</sub>	Input Noise Current Density	$f_0 = 10\text{kHz}$ , $R_L = 10k\Omega$ to $V_{CM}$		0.35		$\text{pA}/\sqrt{\text{Hz}}$
CMRR at 120Hz	Input Common Mode Rejection Ratio	$V_{CM} = 0.1V_{P-P}$ , $R_L = 10k\Omega$ to $V_{CM}$		90		dB
PSRR+ at 120Hz	Power Supply Rejection Ratio (V+)	$V_+$ , $V_- = \pm 1.2V$ and $\pm 2.5V$ , $V_{SOURCE} = 0.1V_{P-P}$ , $R_L = 10k\Omega$ to $V_{CM}$		88		dB
PSRR- at 120Hz	Power Supply Rejection Ratio (V-)	$V_+$ , $V_- = \pm 1.2V$ and $\pm 2.5V$ , $V_{SOURCE} = 0.1V_{P-P}$ , $R_L = 10k\Omega$ to $V_{CM}$		105		dB
Crosstalk at 10kHz	Channel A to Channel B	$V_+$ , $V_- = \pm 2.5V$ ; $A_V = 1$ $V_{SOURCE} = 0.4V_{P-P}$ , $R_L = 10k\Omega$ to $V_{CM}$		140		dB
<b>TRANSIENT RESPONSE</b>						
SR	Slew Rate	$V_{OUT} = \pm 1.5V$ ; $R_f = 50k\Omega$ , $R_G = 50k\Omega$ to $V_{CM}$		$\pm 1.8$		$\text{V}/\mu\text{s}$
t <sub>r</sub> , t <sub>f</sub> , Large Signal	Rise Time, 10% to 90%, V <sub>OUT</sub>	$A_V = -1$ , $V_{OUT} = 4V_{P-P}$ , $R_L = 10k\Omega$ to $V_{CM}$		2.1		$\mu\text{s}$
	Fall Time, 90% to 10%, V <sub>OUT</sub>	$A_V = -1$ , $V_{OUT} = 4V_{P-P}$ , $R_L = 10k\Omega$ to $V_{CM}$		2		$\mu\text{s}$
t <sub>r</sub> , t <sub>f</sub> , Small Signal	Rise Time, 10% to 90%, V <sub>OUT</sub>	$A_V = +1$ , $V_{OUT} = 100\text{mV}_{P-P}$ , $R_L = 10k\Omega$ to $V_{CM}$		60		ns
	Fall Time, 90% to 10%, V <sub>OUT</sub>	$A_V = +1$ , $V_{OUT} = 100\text{mV}_{P-P}$ , $R_L = 10k\Omega$ to $V_{CM}$		50		ns
t <sub>s</sub>	Settling Time to 0.01%; 4V Step	$V_{OUT} = 4V_{P-P}$ ; $R_L = 10k\Omega$ to $V_{CM}$		5.1		$\mu\text{s}$

## NOTE:

6. Parameters with MIN and/or MAX limits are 100% tested at  $+25^\circ\text{C}$ , unless otherwise specified. Temperature limits established by characterization and are not production tested.

# Typical Performance Curves

$V_+ = 5V, V_- = 0V, V_{CM} = 2.5V, R_L = \text{Open}$ . Plots labeled Min, Median, and Max correspond to a distribution of devices in the SOIC package.

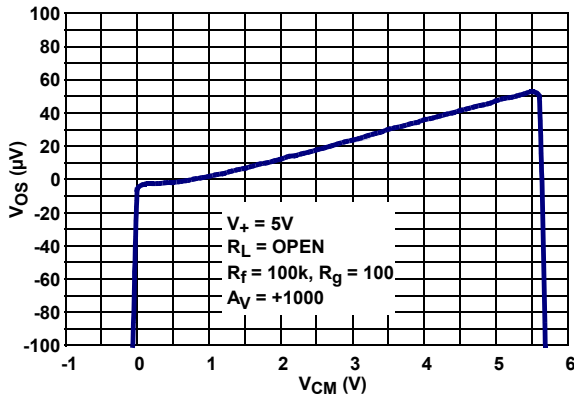

FIGURE 1. INPUT OFFSET VOLTAGE vs COMMON-MODE INPUT VOLTAGE

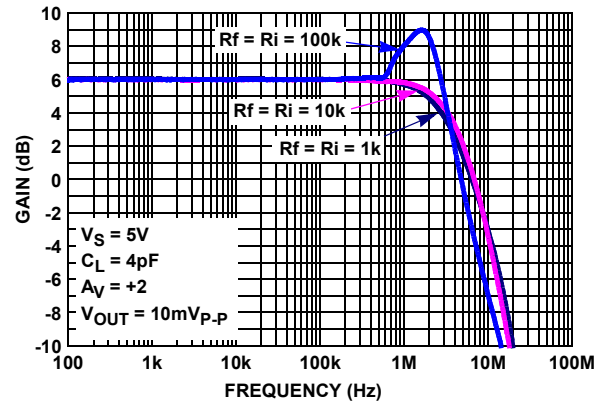

FIGURE 2. GAIN vs FREQUENCY vs FEEDBACK RESISTOR VALUES  $R_f/R_g$

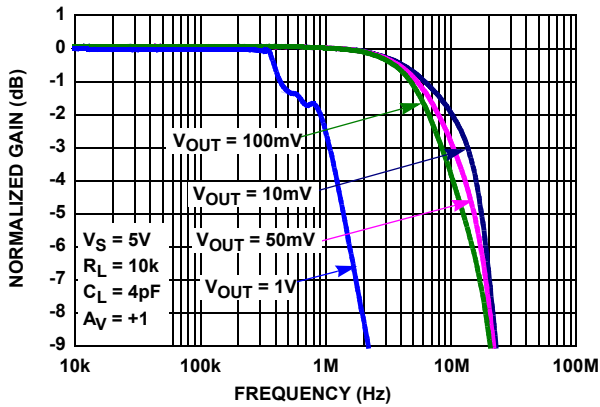

FIGURE 3. GAIN vs FREQUENCY vs  $V_{OUT}, R_L = 10k$

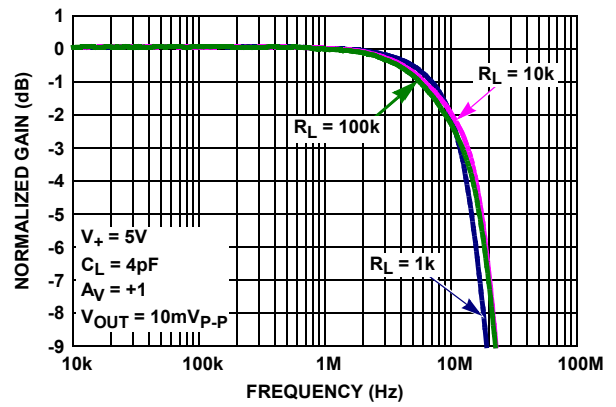

FIGURE 4. GAIN vs FREQUENCY vs  $R_L$

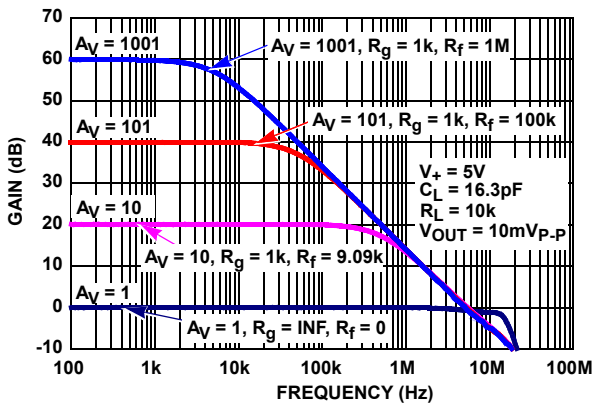

FIGURE 5. FREQUENCY RESPONSE vs CLOSED LOOP GAIN

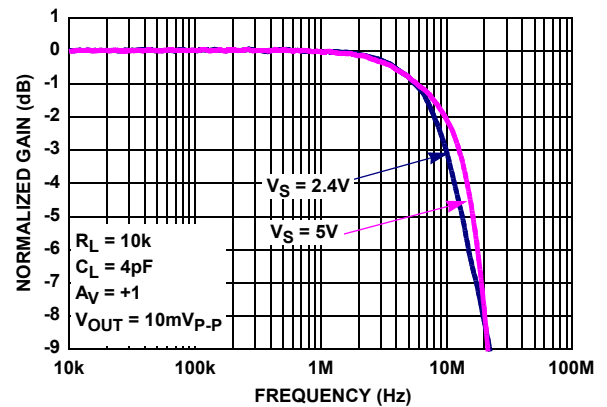

FIGURE 6. GAIN vs FREQUENCY vs SUPPLY VOLTAGE

# Typical Performance Curves

$V_+ = 5V, V_- = 0V, V_{CM} = 2.5V, R_L = \text{Open}$ . Plots labeled Min, Median, and Max correspond to a distribution of devices in the SOIC package. (Continued)

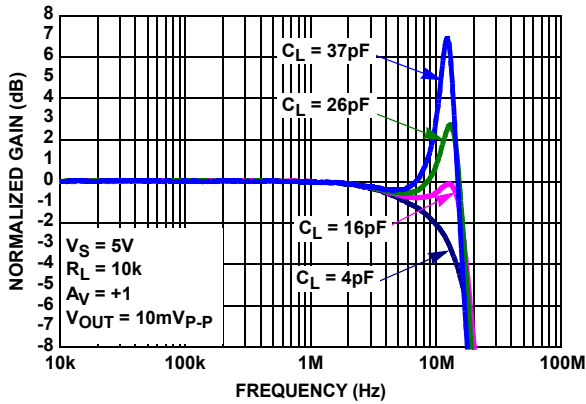

FIGURE 7. GAIN vs FREQUENCY vs  $C_L$

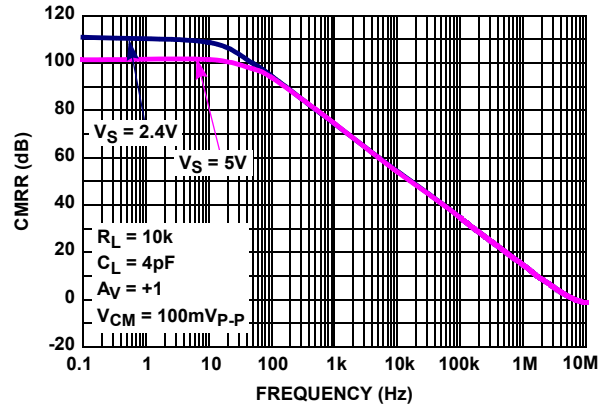

FIGURE 8. CMRR vs FREQUENCY;  $V_+ = 2.4V$  AND  $5V$

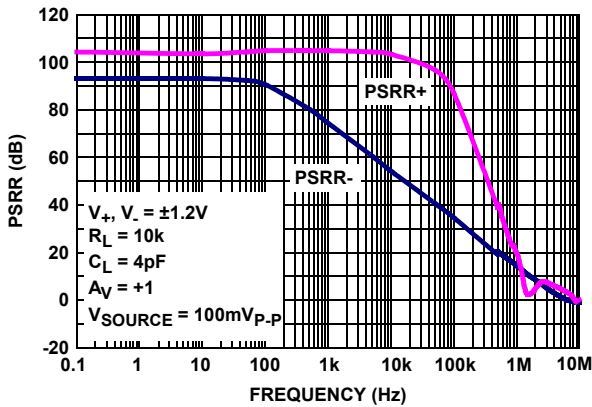

FIGURE 9. PSRR vs FREQUENCY,  $V_+, V_- = \pm 1.2V$

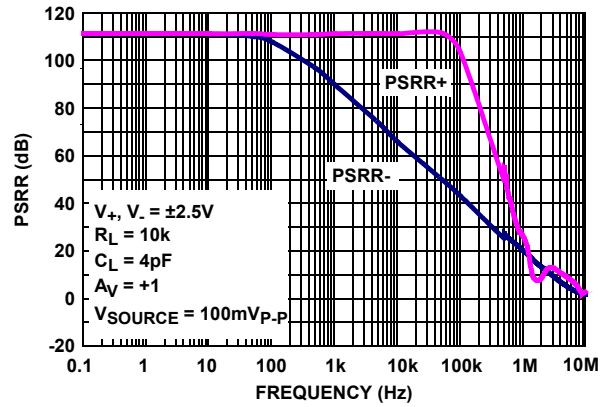

FIGURE 10. PSRR vs FREQUENCY,  $V_+, V_- = \pm 2.5V$

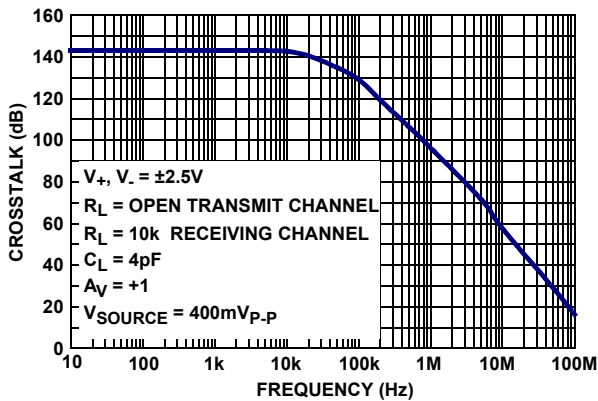

FIGURE 11. CROSSTALK vs FREQUENCY,  $V_+, V_- = \pm 2.5V$

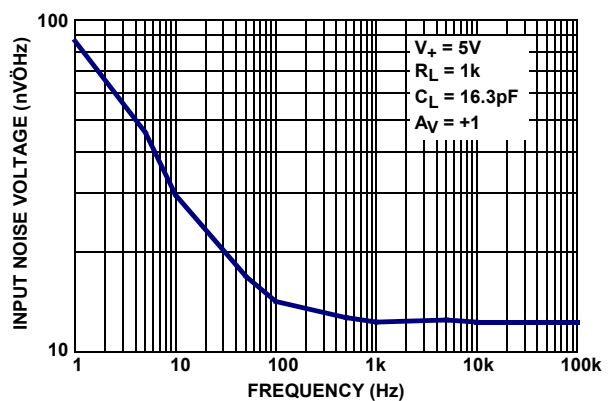

FIGURE 12. INPUT NOISE VOLTAGE DENSITY vs FREQUENCY

## Typical Performance Curves

$V_+ = 5V, V_- = 0V, V_{CM} = 2.5V, R_L = \text{Open}$ . Plots labeled Min, Median, and Max correspond to a distribution of devices in the SOIC package. (Continued)

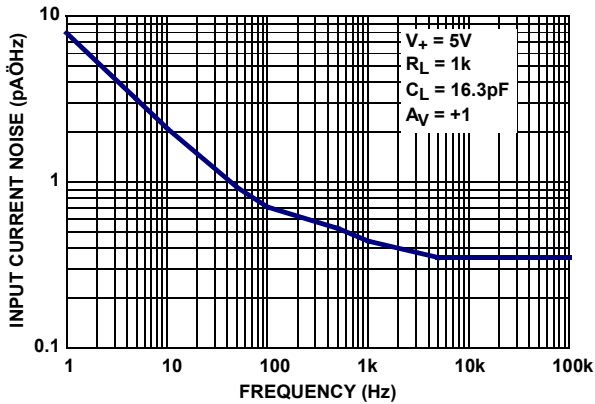

FIGURE 13. INPUT CURRENT NOISE DENSITY vs FREQUENCY

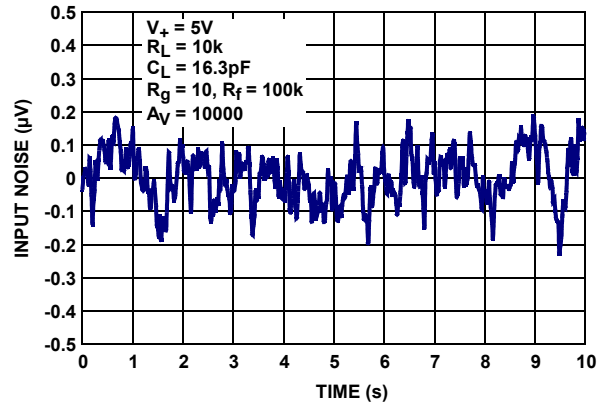

FIGURE 14. INPUT NOISE VOLTAGE 0.1Hz TO 10Hz

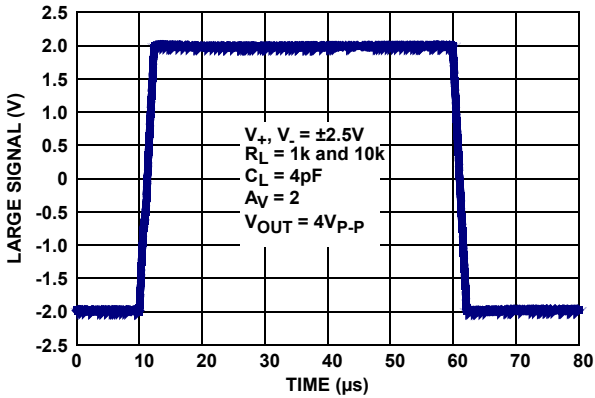

FIGURE 15. LARGE SIGNAL STEP RESPONSE

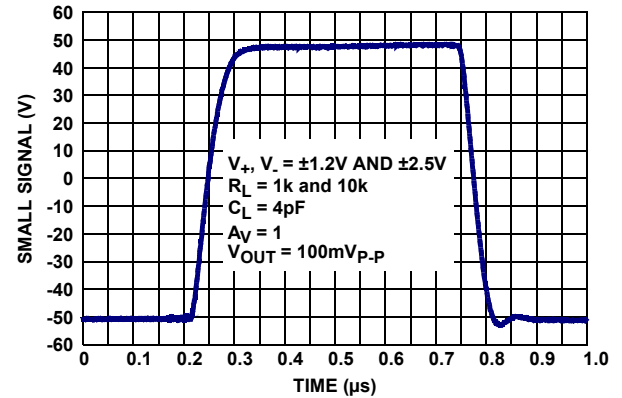

FIGURE 16. SMALL SIGNAL STEP RESPONSE

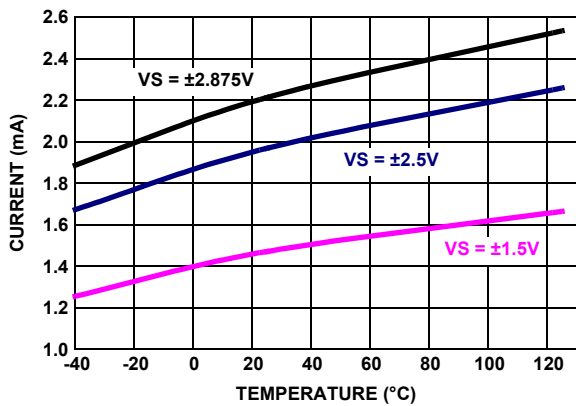

FIGURE 17. SUPPLY CURRENT vs TEMPERATURE vs SUPPLY VOLTAGE

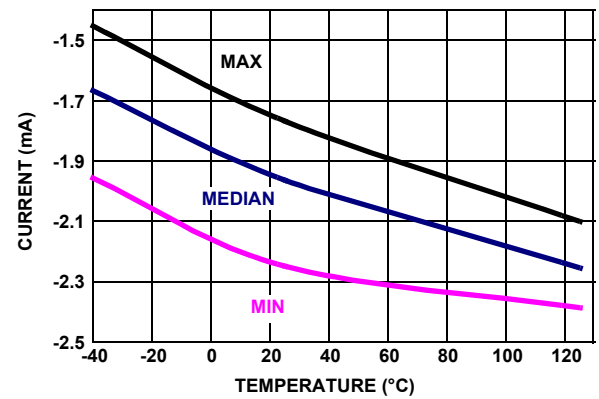

FIGURE 18. NEGATIVE SUPPLY CURRENT vs TEMPERATURE,  $V_+, V_- = \pm 2.5V$

# Typical Performance Curves

$V_+ = 5V, V_- = 0V, V_{CM} = 2.5V, R_L = \text{Open}$ . Plots labeled Min, Median, and Max correspond to a distribution of devices in the SOIC package. (Continued)

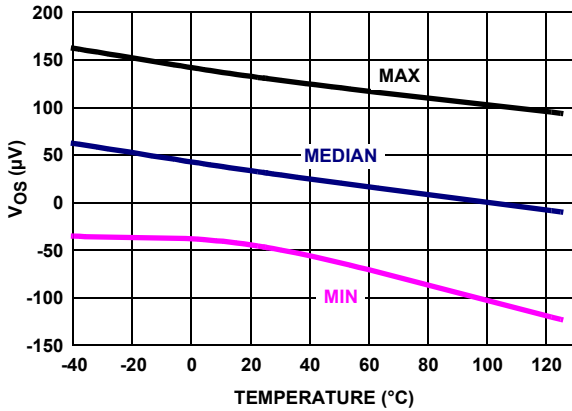

FIGURE 19.  $V_{OS}$  vs TEMPERATURE,  $V_+, V_- = \pm 1.2V$

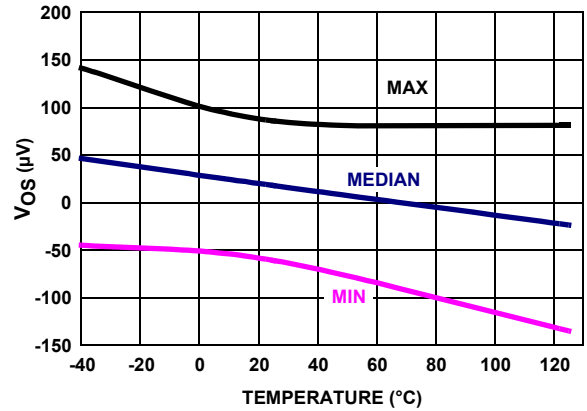

FIGURE 20.  $V_{OS}$  vs TEMPERATURE,  $V_+, V_- = \pm 2.5V$

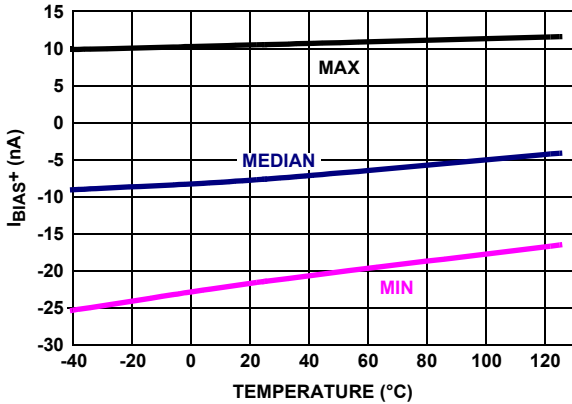

FIGURE 21.  $I_{BIAS+}$  vs TEMPERATURE,  $V_+, V_- = \pm 2.5V$

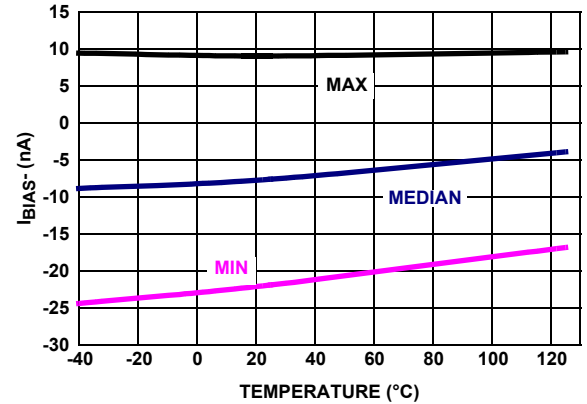

FIGURE 22.  $I_{BIAS-}$  vs TEMPERATURE,  $V_+, V_- = \pm 2.5V$

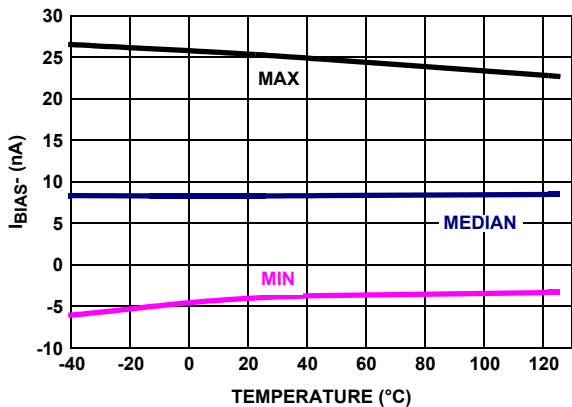

FIGURE 23.  $I_{BIAS+}$  vs TEMPERATURE,  $V_+, V_- = \pm 1.2V$

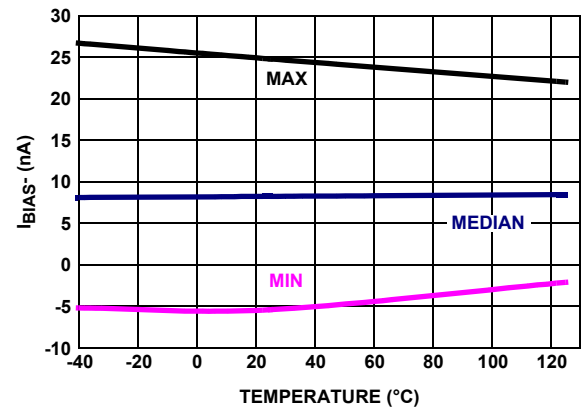

FIGURE 24.  $I_{BIAS-}$  vs TEMPERATURE,  $V_+, V_- = \pm 1.2V$



## Typical Performance Curves

$V_+ = 5V, V_- = 0V, V_{CM} = 2.5V, R_L = \text{Open}$ . Plots labeled Min, Median, and Max correspond to a distribution of devices in the SOIC package. (Continued)

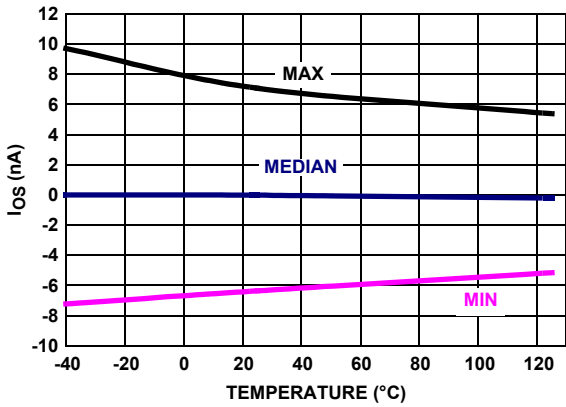

FIGURE 25.  $I_{OS}$  vs TEMPERATURE,  $V_+, V_- = \pm 2.5V$

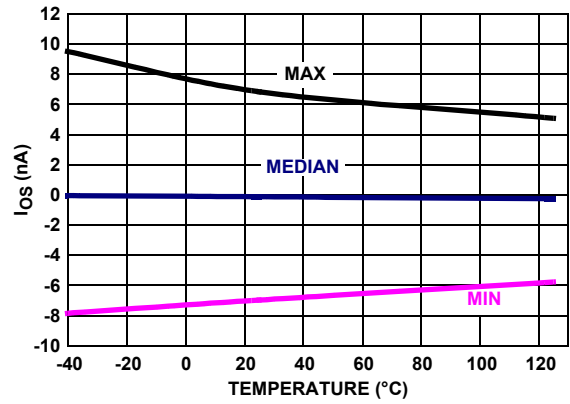

FIGURE 26.  $I_{OS}$  vs TEMPERATURE,  $V_+, V_- = \pm 1.2V$

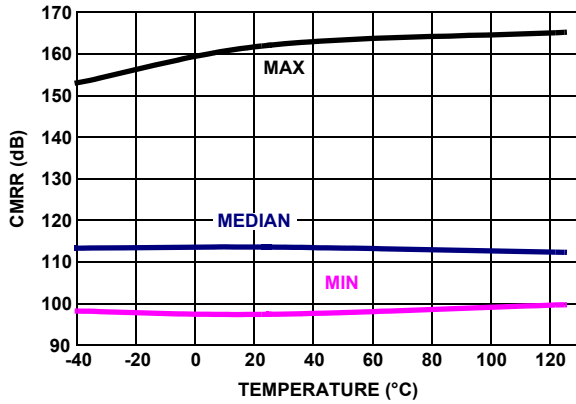

FIGURE 27. CMRR vs TEMPERATURE,  $V_+, V_- = \pm 2.5V$

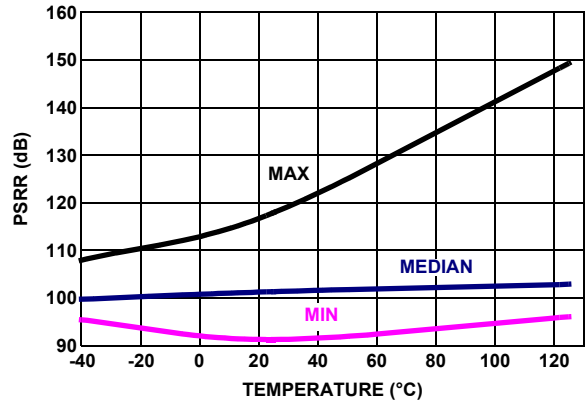

FIGURE 28. PSRR vs TEMPERATURE,  $V_+, V_- = \pm 1.2V$

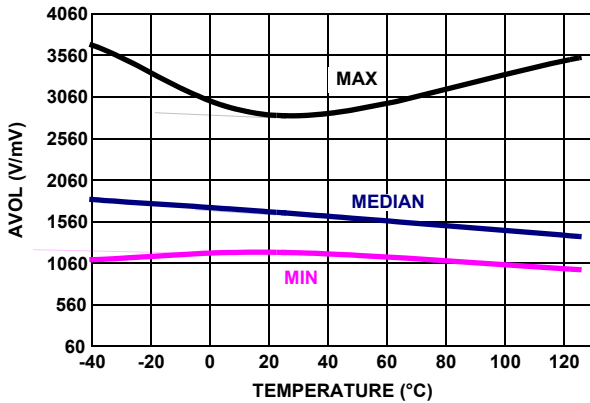

FIGURE 29. AVOL vs TEMPERATURE,  $V_+, V_- = \pm 2.5V, V_O = -2V \text{ TO } +2V, R_L = 100k$

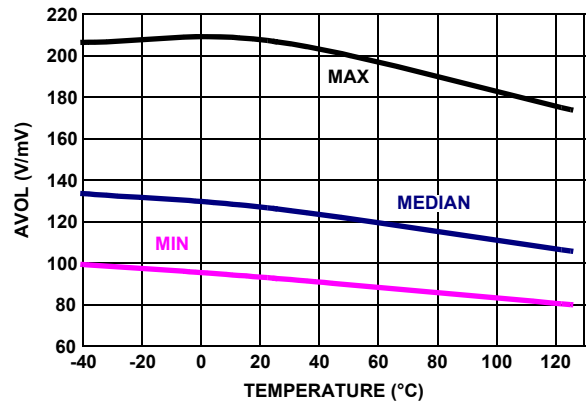

FIGURE 30. AVOL vs TEMPERATURE,  $V_+, V_- = \pm 2.5V, V_O = -2V \text{ TO } +2V, R_L = 1k$

## Typical Performance Curves

$V_+ = 5V, V_- = 0V, V_{CM} = 2.5V, R_L = \text{Open}$ . Plots labeled Min, Median, and Max correspond to a distribution of devices in the SOIC package. (Continued)

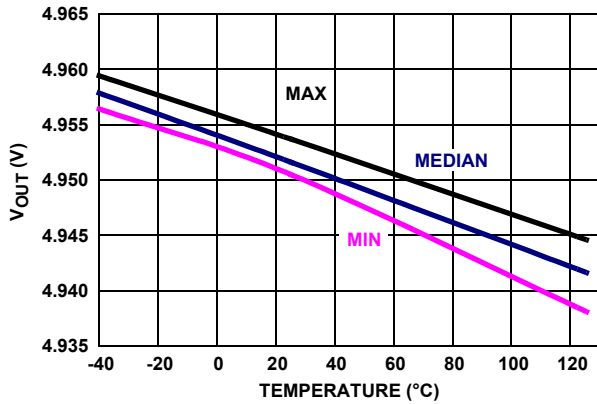

FIGURE 31.  $V_{OUT}$  HIGH vs TEMPERATURE,  $V_+, V_- = \pm 2.5V, R_L = 1k$

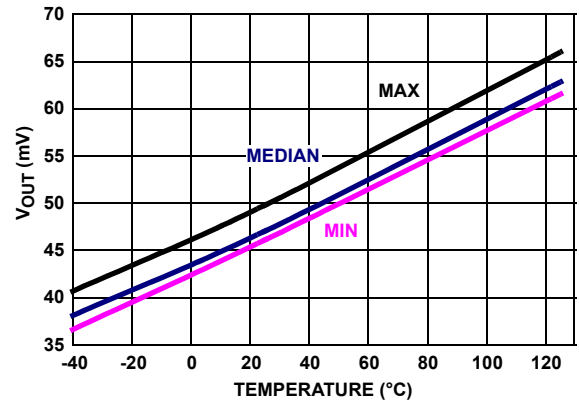

FIGURE 32.  $V_{OUT}$  LOW vs TEMPERATURE,  $V_+, V_- = \pm 2.5V, R_L = 1k$

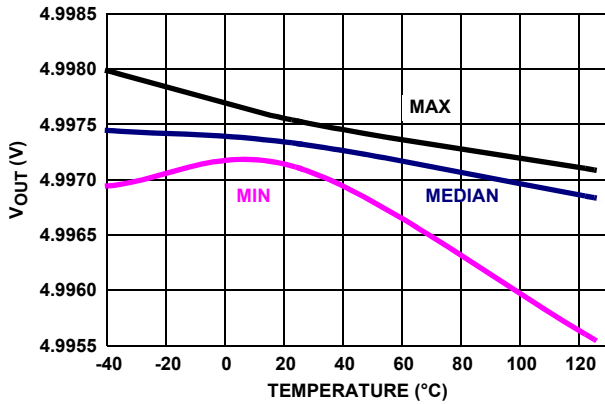

FIGURE 33.  $V_{OUT}$  HIGH vs TEMPERATURE,  $V_+, V_- = \pm 2.5V, R_L = 100k$

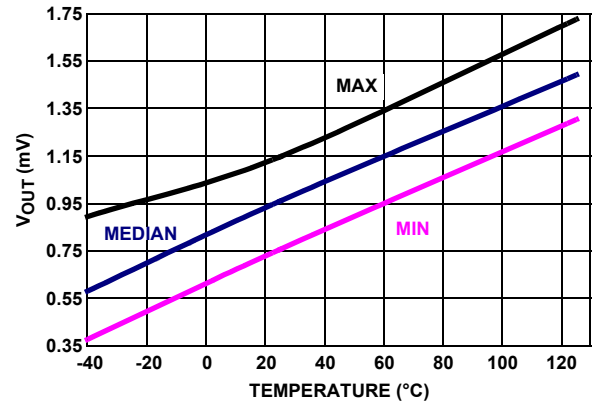

FIGURE 34.  $V_{OUT}$  LOW vs TEMPERATURE,  $V_+, V_- = \pm 2.5V, R_L = 100k$

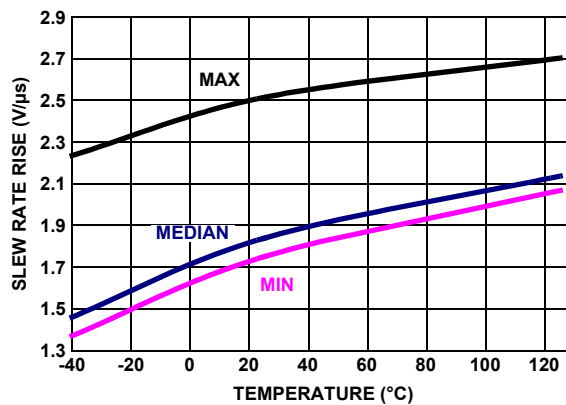

FIGURE 35. SLEW RATE RISE vs TEMPERATURE,  $V_{OUT} = \pm 1.5V, V_{P.P} V_+, V_- = \pm 2.5V, R_L = 100k$

## Applications Information

### Introduction

The ISL28236 is a dual channel Bi-CMOS rail-to-rail input, output (RRIO) micropower precision operational amplifier. The part is designed to operate from a single supply (2.4V to 5.5V) or a dual supply ( $\pm 1.2V$  to  $\pm 2.75V$ ). The ISL28236 has an input common mode range that extends 0.25V above the positive rail and down to the negative supply rail. The output operation can swing within about 3mV of the supply rails with a 100k $\Omega$  load.

### Rail-to-Rail Input

Many rail-to-rail input stages use two differential input pairs, a long-tail PNP (or PFET) and an NPN (or NFET). Severe penalties have to be paid for this circuit topology. As the input signal moves from one supply rail to another, the operational amplifier switches from one input pair to the other. Thus causing drastic changes in input offset voltage and an undesired change in magnitude and polarity of input offset current.

The ISL28236 solves this problem using an internal charge pump to provide a voltage boost to the V+ supply rail driving the input differential pair. This results in extending the input common mode voltage rails to 0.25V beyond the V+ positive rail. The input offset voltage exhibits a smooth behavior throughout the extended common-mode input range. The input bias current versus the common-mode voltage range gives an undistorted behavior from the negative rail to 0.25V higher than the positive rail.

### Power Supply Decoupling

The internal charge pump operates at approximately 27MHz and oscillator ripple doesn't show up in the 5MHz bandwidth of the amplifier. Good power supply decoupling with 0.01 $\mu F$  capacitors at each device power supply pin, is the most effective way to reduce oscillator ripple at the amplifier output. [Figure 36](#) shows the electrical connection of these capacitors using split power supplies. For single supply operation with V- tied to a ground plane, only a single 0.01 $\mu F$  capacitor from V+ is needed. When multiple ISL28236 op amps are used on a single PC board, each op amp will require a 0.01 $\mu F$  decoupling capacitor at each supply pin.

### Rail-to-Rail Output

The rail-to-rail output stage uses CMOS devices that typically swing to within 3mV of the supply rails with a 100k $\Omega$  load. The NMOS sinks current to swing the output in the negative direction. The PMOS sources current to swing the output in the positive direction.

### Current Limiting

These devices have no internal current limiting circuitry. If the output is shorted, it is possible to exceed the absolute maximum rating for output current or power dissipation, potentially resulting in the destruction of the device.

### Results Of Overdriving The Output

Caution should be used when overdriving the output for long periods of time. Overdriving the output can occur in two ways.

1. The input voltage times the gain of the amplifier exceeds the supply voltage by a large value or,

2. The output current required is higher than the output stage can deliver.

These conditions can result in a shift in the Input Offset Voltage ( $V_{OS}$ ) (as much as 1 $\mu V$ /hr. of exposure) under these conditions.

### IN+ and IN- Input Protection

All input terminals have internal ESD protection diodes to both positive and negative supply rails, limiting the input voltage to within one diode beyond the supply rails. They also contain back-to-back diodes across the input terminals (see "[Pin Descriptions](#)" on page 2 - Circuit 1). For applications where the input differential voltage is expected to exceed 0.5V, an external series resistor must be used to ensure the input currents never exceed 5mA ([Figure 36](#)).

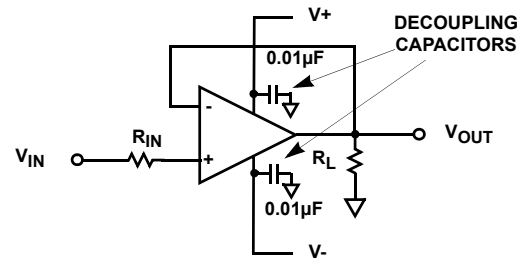

FIGURE 36. LOCAL POWER SUPPLY DECOUPLING AND INPUT CURRENT LIMITING

### Limitations of the Differential Input Protection

If the input differential voltage is expected to exceed 0.5V, an external current limiting resistor must be used to ensure the input current never exceeds 5mA. For non-inverting unity gain applications, the current limiting can be via a series IN+ resistor, or via a feedback resistor of appropriate value. For other gain configurations, the series IN+ resistor is the best choice, unless the feedback ( $R_F$ ) and gain setting ( $R_G$ ) resistors are both sufficiently large to limit the input current to 5mA.

Large differential input voltages can arise from several sources:

1. During open loop (comparator) operation. Used this way, the IN+ and IN- voltages don't track, so differentials arise.
2. When the amplifier is disabled but an input signal is still present. An  $R_L$  or  $R_G$  to GND keeps the IN- at GND, while the varying IN+ signal creates a differential voltage. Mux Amp applications are similar, except that the active channel  $V_{OUT}$  determines the voltage on the IN- terminal.
3. When the slew rate of the input pulse is considerably faster than the op amp's slew rate. If the  $V_{OUT}$  can't keep up with the IN+ signal, a differential voltage results, and visible distortion occurs on the input and output signals. To avoid this issue, keep the input slew rate below 1.9V/ $\mu s$ , or use appropriate current limiting resistors.

Large (>2V) differential input voltages can also cause an increase in disabled  $I_{CC}$ .

## Using Only One Channel

If the application only requires one channel, the user must configure the unused channel to prevent it from oscillating. The unused channel will oscillate if the input and output pins are floating. This will result in higher than expected supply currents and possible noise injection into the channel being used. The proper way to prevent this oscillation is to short the output to the negative input and ground the positive input (as shown in [Figure 37](#)).

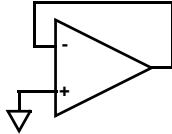

FIGURE 37. PREVENTING OSCILLATIONS IN UNUSED CHANNELS

## Power Dissipation

It is possible to exceed the +125°C maximum junction temperatures under certain load and power supply conditions. It is therefore important to calculate the maximum junction temperature ( $T_{JMAX}$ ) for all applications to determine if power supply voltages, load conditions, or package type need to be modified to remain in the safe operating area. These parameters are related in [Equation 1](#):

$$T_{JMAX} = T_{MAX} + (\theta_{JA} \times P_{D_{MAXTOTAL}}) \quad (EQ. 1)$$

where:

- $P_{D_{MAXTOTAL}}$  is the sum of the maximum power dissipation of each amplifier in the package ( $P_{D_{MAX}}$ )
- $P_{D_{MAX}}$  for each amplifier can be calculated using [Equation 2](#):

$$P_{D_{MAX}} = V_S \times I_{S_{MAX}} + (V_S - V_{OUTMAX}) \times \frac{V_{OUTMAX}}{R_L} \quad (EQ. 2)$$

where:

- $T_{MAX}$  = Maximum ambient temperature
- $\theta_{JA}$  = Thermal resistance of the package
- $P_{D_{MAX}}$  = Maximum power dissipation of 1 amplifier
- $V_S$  = Total supply voltage
- $I_{S_{MAX}}$  = Maximum supply current of 1 amplifier
- $V_{OUTMAX}$  = Maximum output voltage swing of the application
- $R_L$  = Load resistance

## Revision History

The revision history provided is for informational purposes only and is believed to be accurate, but not warranted. Please go to the web to make sure that you have the latest revision.

DATE	REVISION	CHANGE
July 24, 2014	FN6921.2	Ordering information table on page 1: Added T7A parts and Evaluation Board. Thermal Information table on page 3: Added theta JC values to SOIC and MSOP package and updated the notes.
May 20, 2014	FN6921.1	Updated to New Template Updated Ordering Information Table by removing "coming soon" from FUZ parts, Pkg DWG #'s changed from MDP0027 to M8.15E (SOIC) and MDP0043 to M8.118A (MSOP), numbered all notes, added MSL note Updated Electrical Specifications Table by adding conditions for package extension. Added Rev History and About Intersil verbiage.
June 11, 2009	FN6921.0	Initial Release.

## About Intersil

Intersil Corporation is a leading provider of innovative power management and precision analog solutions. The company's products address some of the largest markets within the industrial and infrastructure, mobile computing and high-end consumer markets.

For the most updated datasheet, application notes, related documentation and related parts, please see the respective product information page found at [www.intersil.com](http://www.intersil.com).

You may report errors or suggestions for improving this datasheet by visiting [www.intersil.com/ask](http://www.intersil.com/ask).

Reliability reports are also available from our website at [www.intersil.com/support](http://www.intersil.com/support)

© Copyright Intersil Americas LLC 2009-2014. All Rights Reserved.  
All trademarks and registered trademarks are the property of their respective owners.

For additional products, see [www.intersil.com/en/products.html](http://www.intersil.com/en/products.html)

Intersil products are manufactured, assembled and tested utilizing ISO9001 quality systems as noted in the quality certifications found at [www.intersil.com/en/support/qualandreliability.html](http://www.intersil.com/en/support/qualandreliability.html)

*Intersil products are sold by description only. Intersil may modify the circuit design and/or specifications of products at any time without notice, provided that such modification does not, in Intersil's sole judgment, affect the form, fit or function of the product. Accordingly, the reader is cautioned to verify that datasheets are current before placing orders. Information furnished by Intersil is believed to be accurate and reliable. However, no responsibility is assumed by Intersil or its subsidiaries for its use; nor for any infringements of patents or other rights of third parties which may result from its use. No license is granted by implication or otherwise under any patent or patent rights of Intersil or its subsidiaries.*

For information regarding Intersil Corporation and its products, see [www.intersil.com](http://www.intersil.com)

# Package Outline Drawing

## M8.15E

8 LEAD NARROW BODY SMALL OUTLINE PLASTIC PACKAGE

Rev 0, 08/09

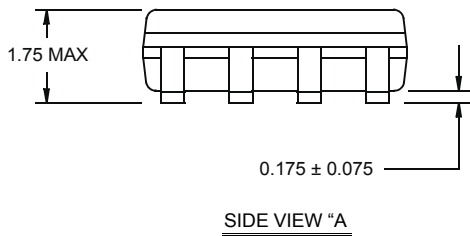
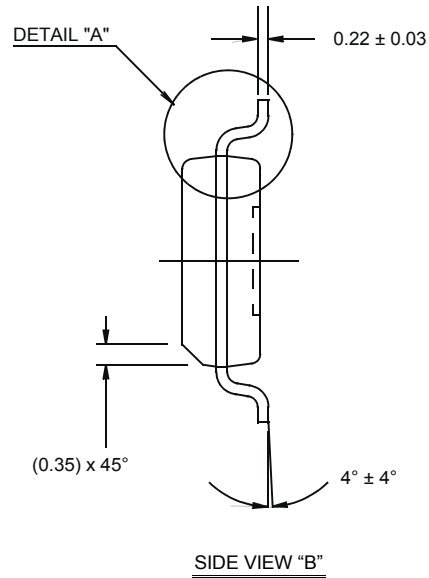

**NOTES:**

1. Dimensions are in millimeters.  
Dimensions in ( ) for Reference Only.
2. Dimensioning and tolerancing conform to AMSE Y14.5m-1994.
3. Unless otherwise specified, tolerance : Decimal ± 0.05
4. Dimension does not include interlead flash or protrusions.  
Interlead flash or protrusions shall not exceed 0.25mm per side.
5. The pin #1 identifier may be either a mold or mark feature.
6. Reference to JEDEC MS-012.

# Package Outline Drawing

## M8.118A

8 LEAD MINI SMALL OUTLINE PLASTIC PACKAGE (MSOP)

Rev 0, 9/09

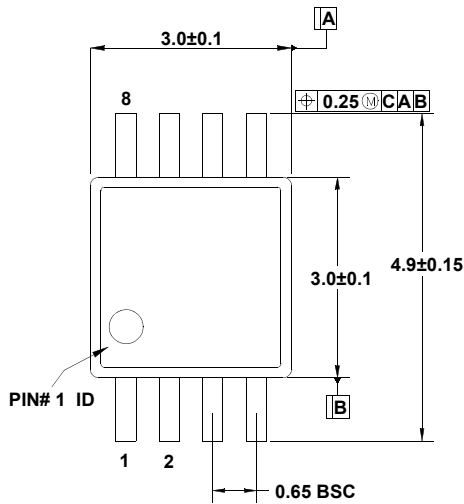

**TOP VIEW**

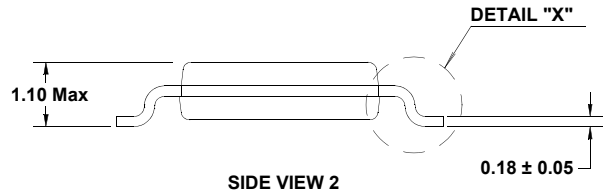

**SIDE VIEW 2**

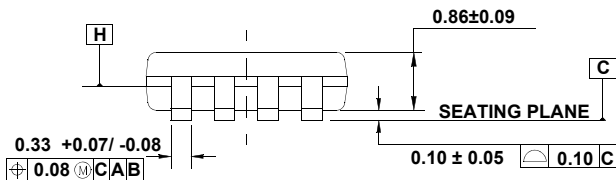

**SIDE VIEW 1**

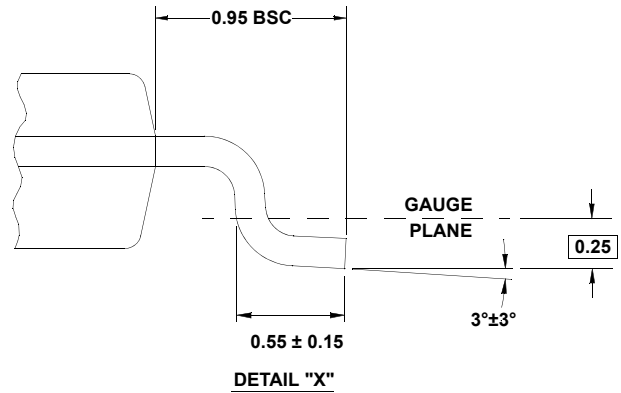

**DETAIL "X"**

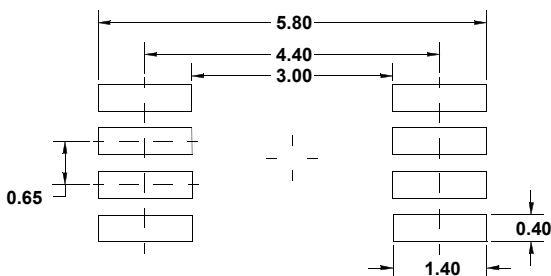

**TYPICAL RECOMMENDED LAND PATTERN**

**NOTES:**

1. Dimensions are in millimeters.
2. Dimensioning and tolerancing conform to JEDEC MO-187-AA and AMSE Y14.5m-1994.
3. Plastic or metal protrusions of 0.15mm max per side are not included.
4. Plastic interlead protrusions of 0.25mm max per side are not included.
5. Dimensions "D" and "E1" are measured at Datum Plane "H".
6. This replaces existing drawing # MDP0043 MSOP 8L.

## X-ON Electronics

Largest Supplier of Electrical and Electronic Components

*Click to view similar products for [Precision Amplifiers](#) category:*

*Click to view products by [Renesas](#) manufacturer:*

Other Similar products are found below :

[561681F](#) [LT6005HGN#PBF](#) [LT6238CGN#PBF](#) [LT6238HGN#PBF](#) [OP05CN8#PBF](#) [OP227GN#PBF](#) [LT6020IDD-1#PBF](#) [LT1124CS8#TR](#)  
[NCV20166SN2T1G](#) [NCS20166SN2T1G](#) [NCS21802MUTBG](#) [LT1637MPS8](#) [LT1498IS8](#) [LT1492CS8](#) [TLC27L7CP](#) [TLV2473CDR](#)  
[LMP2234AMA/NOPB](#) [LMP7707MA/NOPB](#) [5962-8859301M2A](#) [LMP2231AMAE/NOPB](#) [LMP2234AMTE/NOPB](#) [LMC6022IM/NOPB](#)  
[LMC6024IM/NOPB](#) [LMC6081IMX/NOPB](#) [LMP2011MA/NOPB](#) [LMP2231AMFE/NOPB](#) [LMP2232BMA/NOPB](#) [LMP2234AMAE/NOPB](#)  
[LMP7717MAE/NOPB](#) [LMV2011MA/NOPB](#) [LT1013DDR](#) [TL034ACDR](#) [TLC2201AMDG4](#) [TLE2024BMDWG4](#) [TS9222IYDT](#)  
[TLV2474AQDRG4Q1](#) [TLV2472QDRQ1](#) [TLC4502IDR](#) [TLC27M2ACP](#) [TLC2652Q-8DG4](#) [OPA2107APG4](#) [TL054AIDR](#) [AD8619WARZ-](#)  
[R7](#) [TLC272CD](#) [AD8539ARMZ](#) [LTC6084HDD#PBF](#) [LT1638CMS8#TRPBF](#) [LTC1050CN8#PBF](#) [LT1112ACN8#PBF](#) [LT1996AIDD#PBF](#)