

ISL28148, ISL28248

4.5MHz, Single and Dual Precision Rail-to-Rail Input-Output Op Amps with Very Low Input Bias Current

FN6337
Rev 5.00
January 22, 2016

The [ISL28148](#), [ISL28248](#) are 4.5MHz low-power single and dual operational amplifiers. The parts are optimized for single supply operation from 2.4V to 5.5V, allowing operation from one lithium cell or two Ni-Cd batteries.

The single and dual feature an Input Range Enhancement Circuit (IREC), which enables them to maintain CMRR performance for input voltages greater than the positive supply. The input signal is capable of swinging 0.25V above the positive supply and to 100mV below the negative supply with only a slight degradation of the CMRR performance. The output operation is rail-to-rail.

The parts draw minimal supply current (900µA per amplifier) while meeting excellent DC accuracy, AC performance, noise and output drive specifications. The ISL28148 features an enable pin that can be used to turn the device off and reduce the supply current to a maximum of 16µA. Operation is guaranteed across the -40°C to +125°C temperature range.

Features

- 4.5MHz gain bandwidth product
- 900µA supply current (per amplifier)
- 1.8mV maximum offset voltage (ISL28248)
- 1pA typical input bias current
- Down to 2.4V single supply operation
- Rail-to-rail input and output
- Enable pin (ISL28148 SOT-23 package only)
- -40°C to +125°C operation
- Pb-free (RoHS compliant)

Applications

- Low-end audio
- 4mA to 20mA current loops
- Medical devices
- Sensor amplifiers
- ADC buffers
- DAC output amplifiers

Ordering Information

| PART NUMBER (Notes 2, 3) | PART MARKING | TAPE AND REEL QUANTITY (UNITS) | PACKAGE (RoHS Compliant) | PKG. DWG. # |
|------------------------------|------------------|-----------------------------------|-----------------------------|----------------|
| ISL28148FHZ-T7 (Notes 1, 4) | GABT | 3k | 6 Ld SOT-23 | P6.064A |
| ISL28148FHZ-T7A (Notes 1, 4) | GABT | 250 | 6 Ld SOT-23 | P6.064A |
| ISL28248FBZ | 28248 FBZ | | 8 Ld SOIC | M8.15E |
| ISL28248FBZ-T7 (Note 1) | 28248 FBZ | 1k | 8 Ld SOIC | M8.15E |
| ISL28248FUZ | 8248Z | | 8 Ld MSOP | M8.118A |
| ISL28248FUZ-T7 (Note 1) | 8248Z | 1.5k | 8 Ld MSOP | M8.118A |
| ISL28148EVAL1Z | Evaluation Board | | | |
| ISL28248MSOPEVAL1Z | Evaluation Board | | | |
| ISL28248SOICEVAL1Z | Evaluation Board | | | |

NOTES:

1. Please refer to [TB347](#) for details on reel specifications.
2. These Intersil Pb-free plastic packaged products employ special Pb-free material sets, molding compounds/die attach materials, and 100% matte tin plate plus anneal (e3 termination finish, which is RoHS compliant and compatible with both SnPb and Pb-free soldering operations). Intersil Pb-free products are MSL classified at Pb-free peak reflow temperatures that meet or exceed the Pb-free requirements of IPC/JEDEC J STD-020.
3. For Moisture Sensitivity Level (MSL), please see product information page for [ISL28148](#), [ISL28248](#). For more information on MSL, please see tech brief [TB363](#).
4. The part marking is located on the bottom of the part.

Pin Configurations

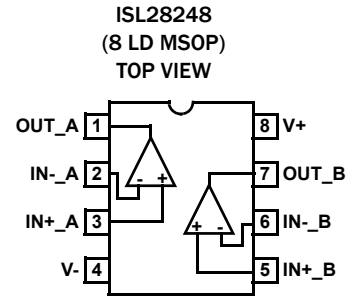
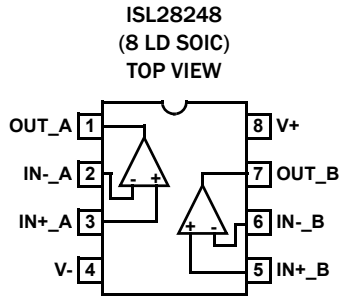
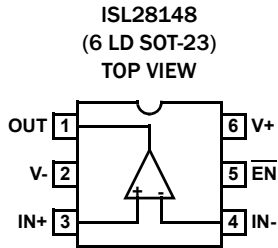

Pin Descriptions

| ISL28148 (6 Ld SOT-23) | ISL28248 (8 Ld SOIC) (8 Ld MSOP) | PIN NAME | FUNCTION | EQUIVALENT CIRCUIT |
|---------------------------|--|-----------------------|--------------------|--------------------|
| 4 | 2 (A) 6 (B) | IN- IN-_A IN-_B | inverting input | <p>Circuit 1</p> |
| 3 | 3 (A) 5 (B) | IN+ IN+_A IN+_B | Noninverting input | (See circuit 1) |
| 2 | 4 | V- | Negative supply | <p>Circuit 2</p> |
| 1 | 1 (A) 7 (B) | OUT OUT_A OUT_B | Output | <p>Circuit 3</p> |
| 6 | 8 | V+ | Positive supply | (See circuit 2) |
| 5 | | EN | Chip enable | <p>Circuit 4</p> |

Absolute Maximum Ratings ($T_A = +25^\circ\text{C}$)

| | |
|----------------------------------|--|
| Supply Voltage | 5.75V |
| Supply Turn On Voltage Slew Rate | 1V/ μs |
| Differential Input Current | 5mA |
| Differential Input Voltage | 0.5V |
| Input Voltage | V ₋ - 0.5V to V ₊ + 0.5V |
| ESD Rating | |
| Human Body Model | 3kV |
| Machine Model | 300V |
| Charged Device Model | 1200V |

Thermal Information

| | |
|---|---|
| Thermal Resistance (Typical, Note 5) | θ_{JA} ($^\circ\text{C}/\text{W}$) |
| 6 Ld SOT-23 Package | 165 |
| 8 Ld SOIC Package | 120 |
| 8 Ld MSOP Package | 160 |
| Ambient Operating Temperature Range | -40 $^\circ\text{C}$ to +125 $^\circ\text{C}$ |
| Storage Temperature Range | -65 $^\circ\text{C}$ to +150 $^\circ\text{C}$ |
| Operating Junction Temperature | +125 $^\circ\text{C}$ |
| Pb-Free Reflow Profile | see TB493 |

CAUTION: Do not operate at or near the maximum ratings listed for extended periods of time. Exposure to such conditions may adversely impact product reliability and result in failures not covered by warranty.

NOTE:

5. θ_{JA} is measured with the component mounted on a high effective thermal conductivity test board in free air. See Tech Brief [TB379](#) for details.

Electrical Specifications ($V_S \pm 5\text{V}$) $V_- = 0\text{V}$, $V_{CM} = 2.5\text{V}$, $R_L = \text{Open}$, $T_A = +25^\circ\text{C}$ unless otherwise specified. **Boldface limits apply across the operating temperature range, -40 $^\circ\text{C}$ to +125 $^\circ\text{C}$. Temperature data established by characterization.**

| PARAMETER | DESCRIPTION | TEST CONDITIONS | MIN (Note 6) | TYP | MAX (Note 6) | UNIT |
|----------------------------------|---------------------------------------|--|-----------------------------------|---------|-----------------------------------|------------------------------|
| V _{OS} | Input Offset Voltage | ISL28148 | -2.3 -2.8 | 0 | 2.3 2.8 | mV |
| | | ISL28248 | -1.8 -2.8 | 0 | 1.8 2.8 | mV |
| $\frac{\Delta V_{OS}}{\Delta T}$ | Input Offset Voltage vs Temperature | | | 0.03 | | $\mu\text{V}/^\circ\text{C}$ |
| I _{OS} | Input Offset Current | $T_A = -40^\circ\text{C}$ to $+85^\circ\text{C}$ | -35 -80 | ± 5 | 35 80 | pA |
| I _B | Input Bias Current | $T_A = -40^\circ\text{C}$ to $+85^\circ\text{C}$ | -30 -80 | ± 1 | 30 80 | pA |
| CMIR | Common-Mode Voltage Range | Guaranteed by CMRR | 0 | | 5 | V |
| CMRR | Common-Mode Rejection Ratio | $V_{CM} = 0\text{V}$ to 5V | 75 70 | 98 | | dB |
| PSRR | Power Supply Rejection Ratio | $V_+ = 2.4\text{V}$ to 5.5V | 80 75 | 98 | | dB |
| A _{VOL} | Large Signal Voltage Gain | $V_O = 0.5\text{V}$ to 4.5V , $R_L = 100\text{k}\Omega$ to V_{CM} | 200 150 | 580 | | V/mV |
| | | $V_O = 0.5\text{V}$ to 4.5V , $R_L = 1\text{k}\Omega$ to V_{CM} | | 50 | | V/mV |
| V _{OUT} | Maximum Output Voltage Swing | Output low, $R_L = 100\text{k}\Omega$ to V_{CM} | | 3 | 6 8 | mV |
| | | Output low, $R_L = 1\text{k}\Omega$ to V_{CM} | | 50 | 70 110 | mV |
| | | Output high, $R_L = 100\text{k}\Omega$ to V_{CM} | 4.994 4.99 | 4.998 | | V |
| | | Output high, $R_L = 1\text{k}\Omega$ to V_{CM} | 4.93 4.89 | 4.95 | | V |
| I _{S,ON} | Quiescent Supply Current, Enabled | Per Amplifier | | 0.9 | 1.25 1.4 | mA |
| I _{S,OFF} | Quiescent Supply Current, Disabled | ISL28148 SOT-23 package only | | 10 | 14 16 | μA |
| I _{O+} | Short-Circuit Output Source Current | $R_L = 10\Omega$ to V_{CM} | 48 45 | 75 | | mA |
| I _{O-} | Short-Circuit Output Sink Current | $R_L = 10\Omega$ to V_{CM} | | -68 | -48 -45 | mA |
| V _{SUPPLY} | Supply Operating Range | V_+ to V_- | 2.4 | | 5.5 | V |
| V _{ENH} | $\overline{\text{EN}}$ Pin High Level | ISL28148 SOT-23 package only | 2 | | | V |

Electrical Specifications ($V_S \pm 5V$) $V_- = 0V$, $V_{CM} = 2.5V$, $R_L = \text{Open}$, $T_A = +25^\circ\text{C}$ unless otherwise specified. **Boldface limits apply across the operating temperature range, -40°C to $+125^\circ\text{C}$. Temperature data established by characterization. (Continued)**

| PARAMETER | DESCRIPTION | TEST CONDITIONS | MIN (Note 6) | TYP | MAX (Note 6) | UNIT |
|------------------------------|---|--|-----------------|---------|--------------------------|------------------------------|
| V_{ENL} | \overline{EN} Pin Low Level | ISL28148 SOT-23 package only | | | 0.8 | V |
| I_{ENH} | \overline{EN} Pin Input High Current | $V_{\overline{EN}} = V_+$, ISL28148 SOT-23 package only | | 1 | 1.5 1.6 | μA |
| I_{ENL} | \overline{EN} Pin Input Low Current | $V_{\overline{EN}} = V_-$, ISL28148 SOT-23 package only | | 12 | 25 30 | nA |
| AC SPECIFICATIONS | | | | | | |
| GBW | Gain Bandwidth Product | $A_V = 100$, $R_f = 100\text{k}\Omega$, $R_g = 1\text{k}\Omega$, $R_L = 10\text{k}\Omega$ to V_{CM} | | 4.5 | | MHz |
| Unity Gain Bandwidth | -3dB Bandwidth | $A_V = 1$, $R_f = 0\Omega$, $V_{OUT} = 10\text{mV}_{P-P}$, $R_L = 10\text{k}\Omega$ to V_{CM} | | 13 | | MHz |
| e_N | Input Noise Voltage Peak-to-Peak | $f = 0.1\text{Hz}$ to 10Hz | | 2 | | μV_{PP} |
| | Input Noise Voltage Density | $f_0 = 1\text{kHz}$ | | 28 | | $\text{nV}/\sqrt{\text{Hz}}$ |
| i_N | Input Noise Current Density | $f_0 = 1\text{kHz}$ | | 0.016 | | $\text{pA}/\sqrt{\text{Hz}}$ |
| CMRR at 60Hz | Input Common-Mode Rejection Ratio | $V_{CM} = 1\text{V}_{P-P}$, $R_L = 10\text{k}\Omega$ to V_{CM} | | 85 | | dB |
| PSRR- At 120Hz | Power Supply Rejection Ratio (V_-) | V_+ , $V_- = \pm 1.2\text{V}$ and $\pm 2.5\text{V}$, $V_{SOURCE} = 1\text{V}_{P-P}$, $R_L = 10\text{k}\Omega$ to V_{CM} | | -82 | | dB |
| PSRR+ At 120Hz | Power Supply Rejection Ratio (V_+) | V_+ , $V_- = \pm 1.2\text{V}$ and $\pm 2.5\text{V}$, $V_{SOURCE} = 1\text{V}_{P-P}$, $R_L = 10\text{k}\Omega$ to V_{CM} | | -100 | | dB |
| TRANSIENT RESPONSE | | | | | | |
| SR | Slew Rate | | | ± 4 | | $\text{V}/\mu\text{s}$ |
| t_r , t_f , Large Signal | Rise Time, 10% to 90%, V_{OUT} | $A_V = +2$, $V_{OUT} = 3\text{V}_{P-P}$, $R_g = R_f = 10\text{k}\Omega$, $R_L = 10\text{k}\Omega$ to V_{CM} | | 530 | | ns |
| | Fall Time, 90% to 10%, V_{OUT} | $A_V = +2$, $V_{OUT} = 3\text{V}_{P-P}$, $R_g = R_f = 10\text{k}\Omega$, $R_L = 10\text{k}\Omega$ to V_{CM} | | 530 | | ns |
| t_r , t_f , Small Signal | Rise Time, 10% to 90%, V_{OUT} | $A_V = +2$, $V_{OUT} = 10\text{mV}_{P-P}$, $R_g = R_f = R_L = 10\text{k}\Omega$ to V_{CM} | | 50 | | ns |
| | Fall Time, 90% to 10%, V_{OUT} | $A_V = +2$, $V_{OUT} = 10\text{mV}_{P-P}$, $R_g = R_f = R_L = 10\text{k}\Omega$ to V_{CM} | | 50 | | ns |
| t_{EN} | Enable to Output Turn-On Delay Time, 10% \overline{EN} to 10% V_{OUT} , (ISL28148) | $\overline{EN} = 5\text{V}$ to 0V , $A_V = +2$, $R_g = R_f = R_L = 1\text{k}\Omega$ to V_{CM} | | 5 | | μs |
| | Enable to Output Turn-Off Delay Time, 10% \overline{EN} to 10% V_{OUT} , (ISL28148) | $V_{\overline{EN}} = 0\text{V}$ to 5V , $A_V = +2$, $R_g = R_f = R_L = 1\text{k}\Omega$ to V_{CM} | | 0.2 | | μs |

NOTE:

6. Parameters with MIN and/or MAX limits are 100% tested at $+25^\circ\text{C}$, unless otherwise specified. Temperature limits established by characterization and are not production tested.

Typical Performance Curves $V_+ = 5V, V_- = 0V, V_{CM} = 2.5V, R_L = \text{Open}.$

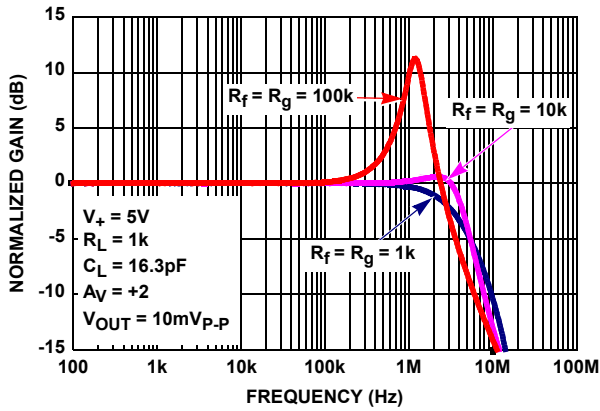

FIGURE 1. GAIN vs FREQUENCY vs FEEDBACK RESISTOR VALUES R_f/R_g

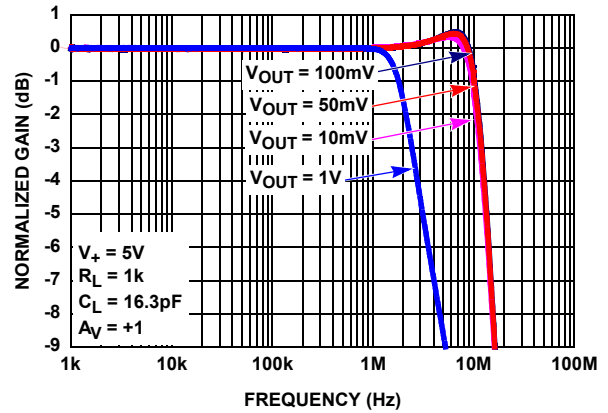

FIGURE 2. GAIN vs FREQUENCY vs $V_{OUT}, R_L = 1k$

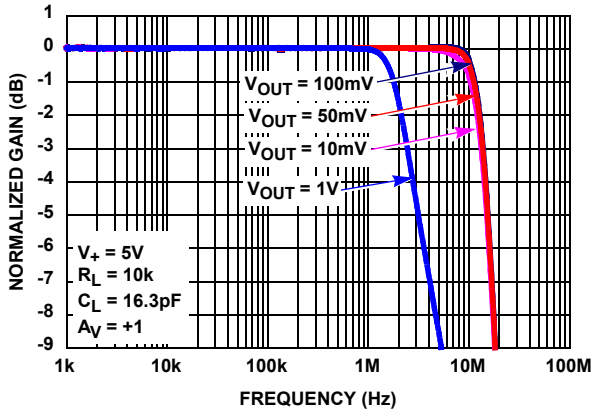

FIGURE 3. GAIN vs FREQUENCY vs $V_{OUT}, R_L = 10k$

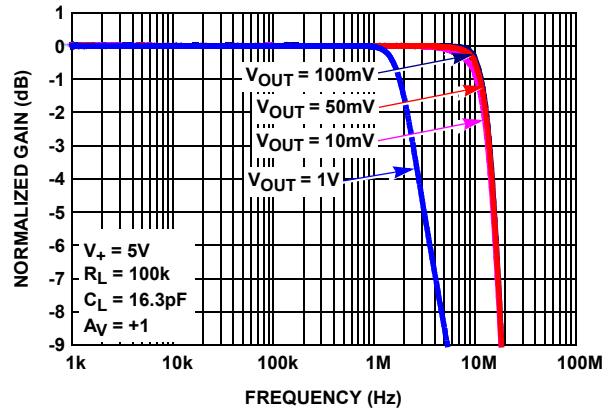

FIGURE 4. GAIN vs FREQUENCY vs $V_{OUT}, R_L = 100k$

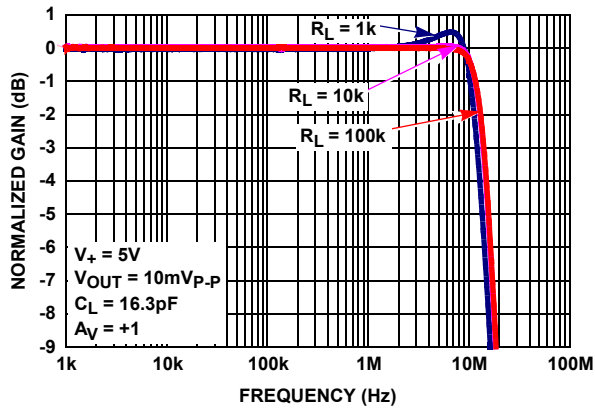

FIGURE 5. GAIN vs FREQUENCY vs R_L

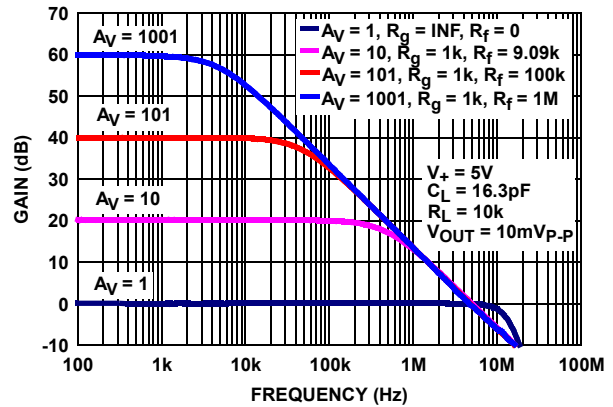

FIGURE 6. FREQUENCY RESPONSE vs CLOSED LOOP GAIN

Typical Performance Curves $V_+ = 5V, V_- = 0V, V_{CM} = 2.5V, R_L = \text{Open. (Continued)}$

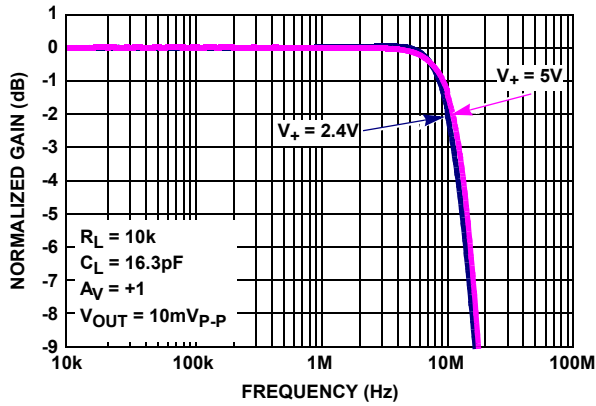

FIGURE 7. GAIN vs FREQUENCY vs SUPPLY VOLTAGE

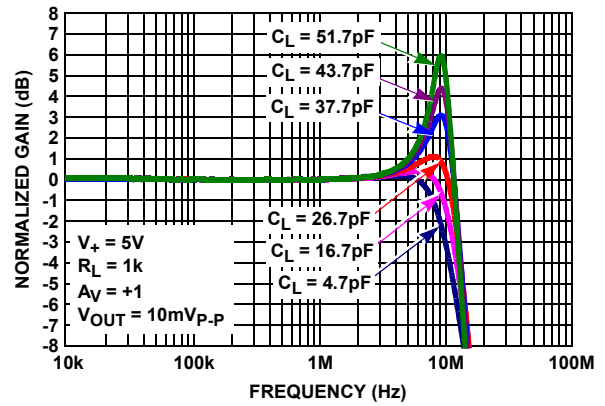

FIGURE 8. GAIN vs FREQUENCY vs C_L

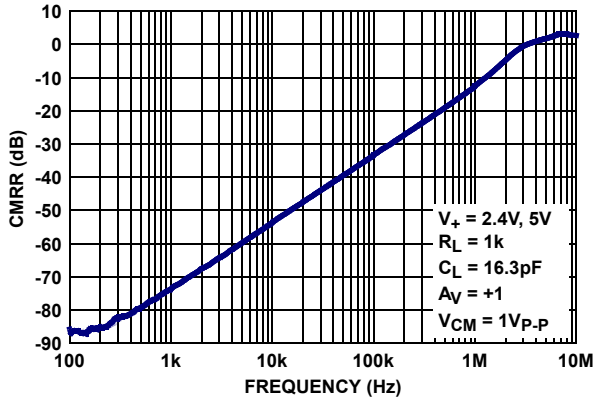

FIGURE 9. CMRR vs FREQUENCY; $V_+ = 2.4V$ AND $5V$

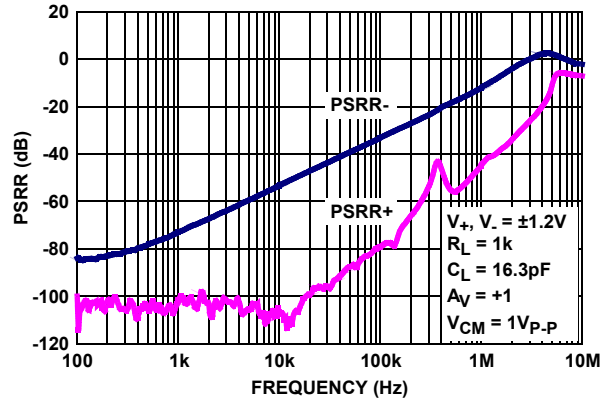

FIGURE 10. PSRR vs FREQUENCY, $V_+, V_- = \pm 1.2V$

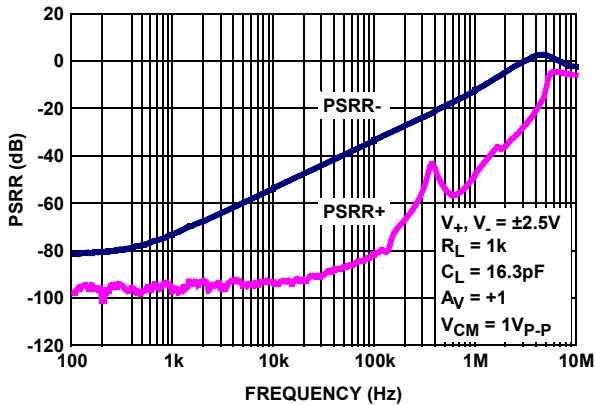

FIGURE 11. PSRR vs FREQUENCY $V_+, V_- = \pm 2.5V$

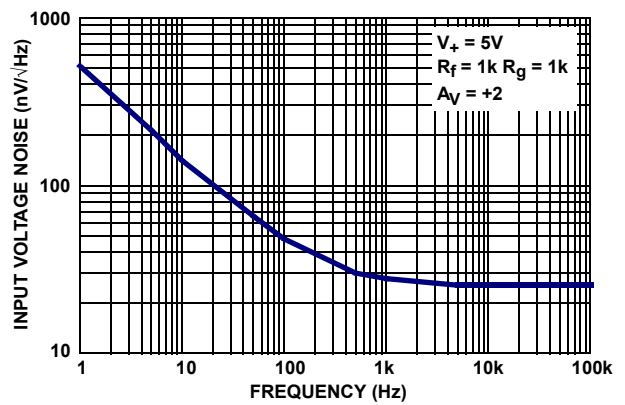

FIGURE 12. INPUT VOLTAGE NOISE DENSITY vs FREQUENCY

Typical Performance Curves $V_+ = 5V, V_- = 0V, V_{CM} = 2.5V, R_L = \text{Open. (Continued)}$

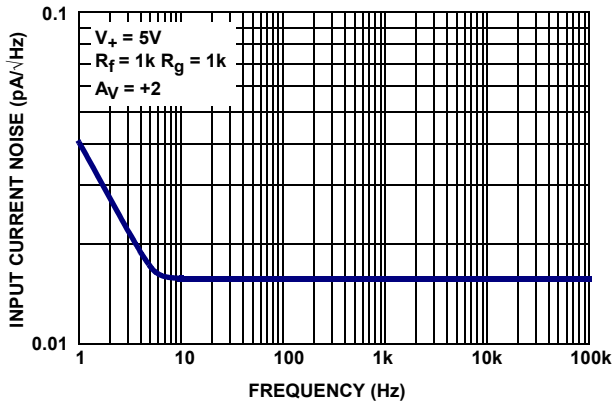

FIGURE 13. INPUT CURRENT NOISE DENSITY vs FREQUENCY

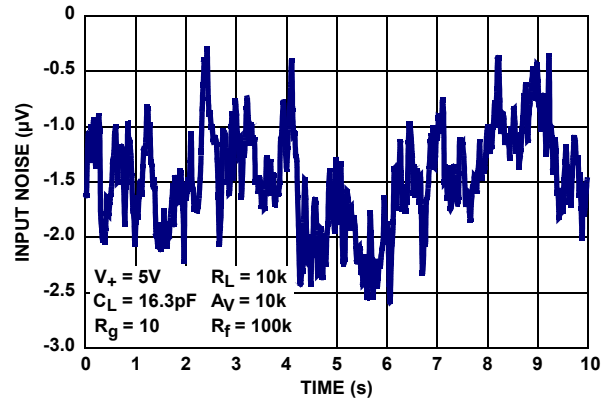

FIGURE 14. INPUT VOLTAGE NOISE 0.1Hz to 10Hz

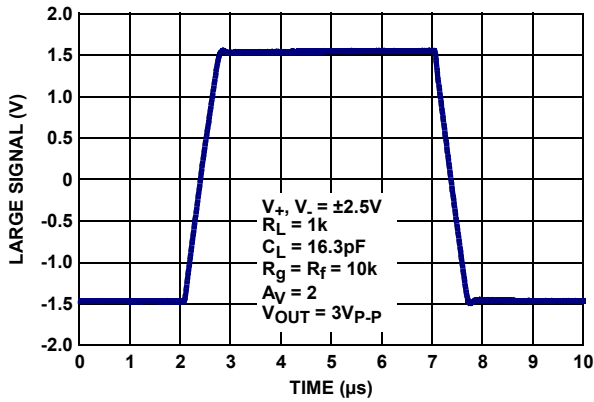

FIGURE 15. LARGE SIGNAL STEP RESPONSE

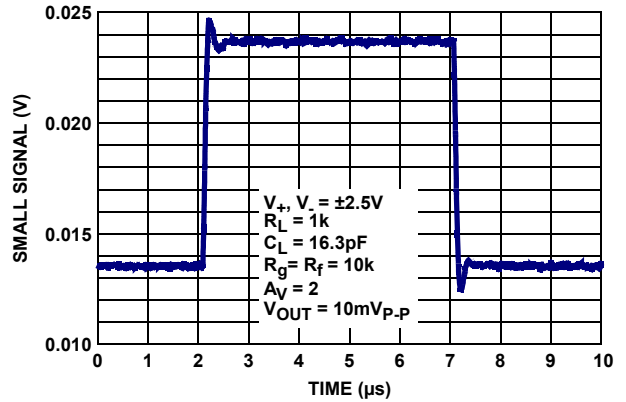

FIGURE 16. SMALL SIGNAL STEP RESPONSE

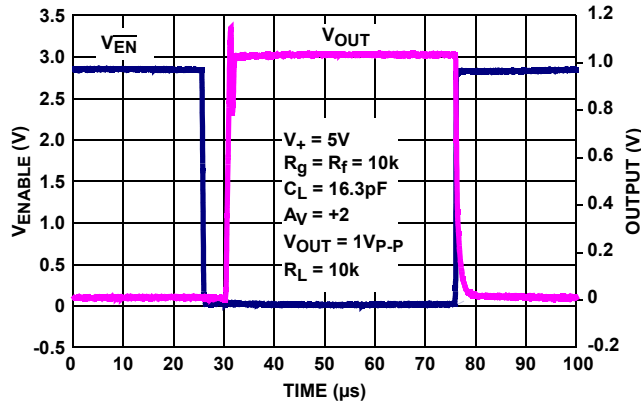

FIGURE 17. ISL28148 ENABLE TO OUTPUT RESPONSE

Typical Performance Curves $V_+ = 5V, V_- = 0V, V_{CM} = 2.5V, R_L = \text{Open. (Continued)}$

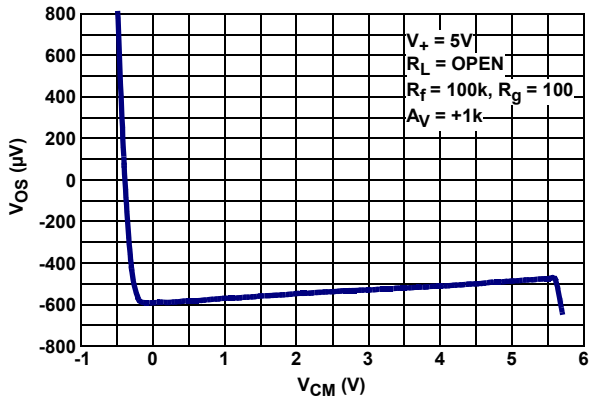

FIGURE 18. INPUT OFFSET VOLTAGE vs COMMON-MODE INPUT VOLTAGE

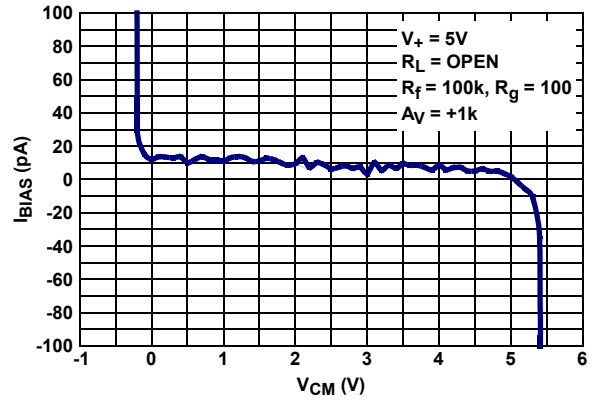

FIGURE 19. INPUT BIAS CURRENT vs COMMON-MODE INPUT VOLTAGE

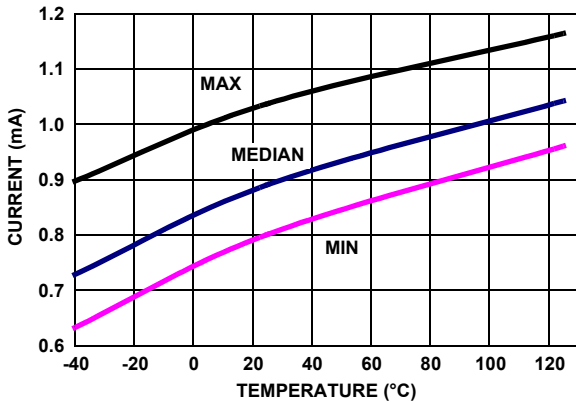

FIGURE 20. SUPPLY CURRENT ENABLED vs TEMPERATURE $V_+, V_- = \pm 2.5V$

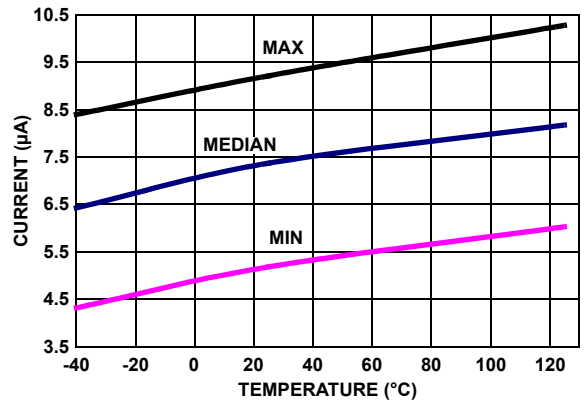

FIGURE 21. SUPPLY CURRENT DISABLED vs TEMPERATURE $V_+, V_- = \pm 2.5V$

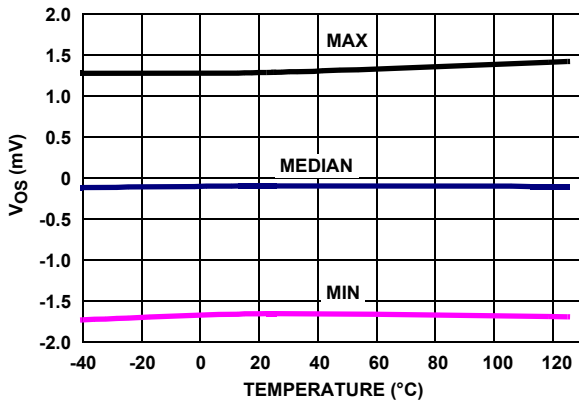

FIGURE 22. V_{OS} vs TEMPERATURE $V_{IN} = 0V, V_+, V_- = \pm 2.75V$

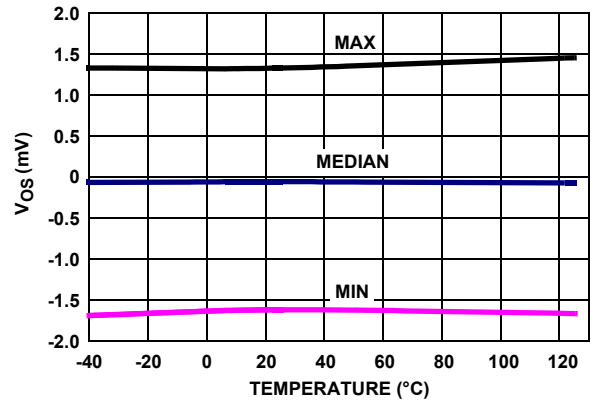

FIGURE 23. V_{OS} vs TEMPERATURE $V_{IN} = 0V, V_+, V_- = \pm 2.5V$

Typical Performance Curves $V_+ = 5V, V_- = 0V, V_{CM} = 2.5V, R_L = \text{Open. (Continued)}$

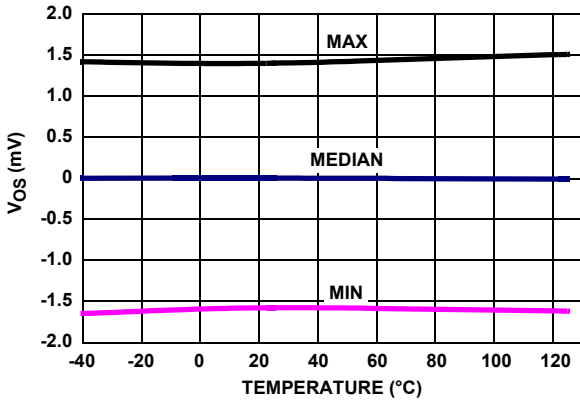

FIGURE 24. V_{OS} vs TEMPERATURE $V_{IN} = 0V, V_+, V_- = \pm 1.2V$

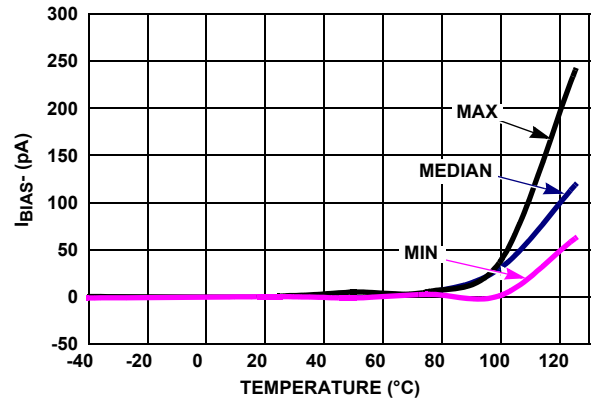

FIGURE 25. I_{BIAS-} vs TEMPERATURE $V_+, V_- = \pm 2.5V$

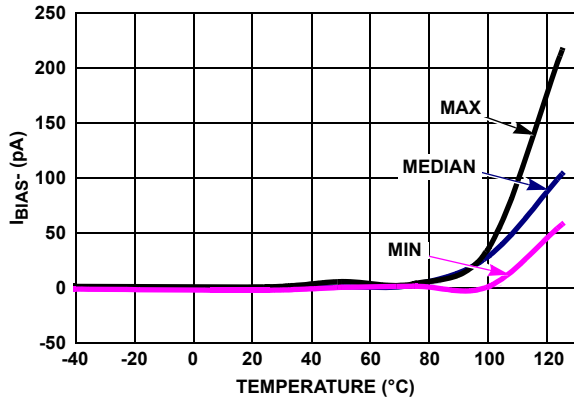

FIGURE 26. I_{BIAS-} vs TEMPERATURE $V_+, V_- = \pm 1.2V$

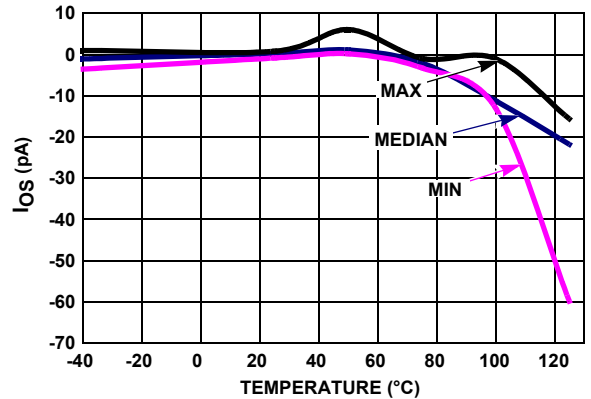

FIGURE 27. I_{OS} vs TEMPERATURE $V_+, V_- = \pm 2.5V$

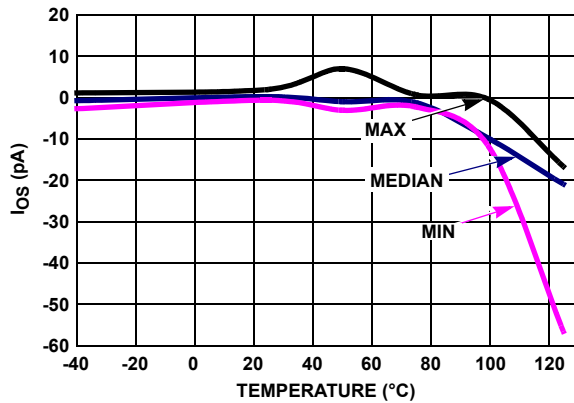

FIGURE 28. I_{OS} vs TEMPERATURE $V_+, V_- = \pm 1.2V$

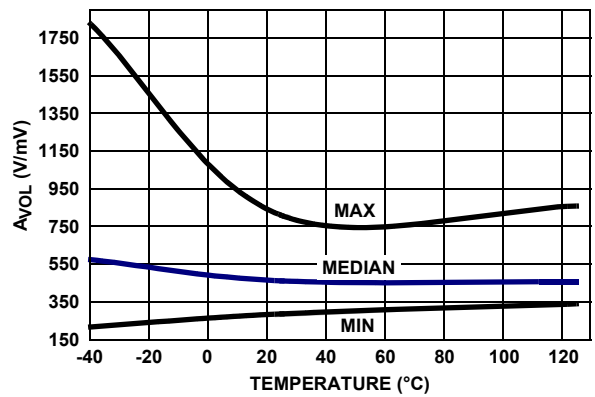

FIGURE 29. A_{VOL} vs TEMPERATURE $R_L = 100k, V_+, V_- = \pm 2.5V, V_O = -2V \text{ TO } +2V$

Typical Performance Curves $V_+ = 5V, V_- = 0V, V_{CM} = 2.5V, R_L = \text{Open. (Continued)}$

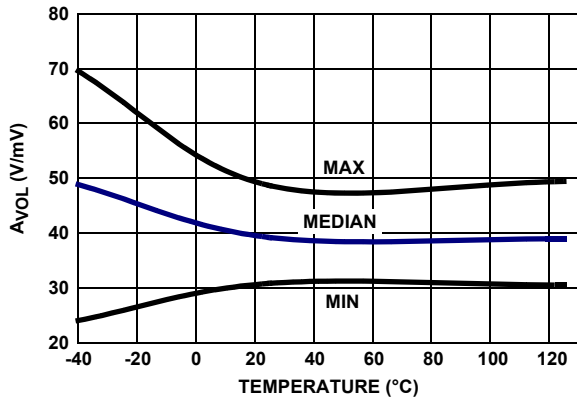

FIGURE 30. A_{VOL} vs TEMPERATURE $R_L = 1k, V_+, V_- = \pm 2.5V, V_0 = -2V$ TO $+2V$

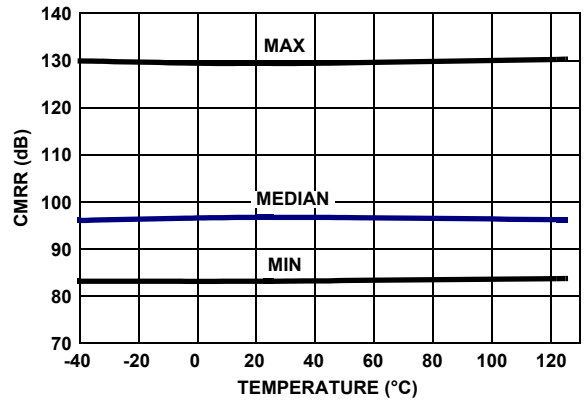

FIGURE 31. CMRR vs TEMPERATURE $V_{CM} = -2.5V$ TO $+2.5V, V_+, V_- = \pm 2.5V$

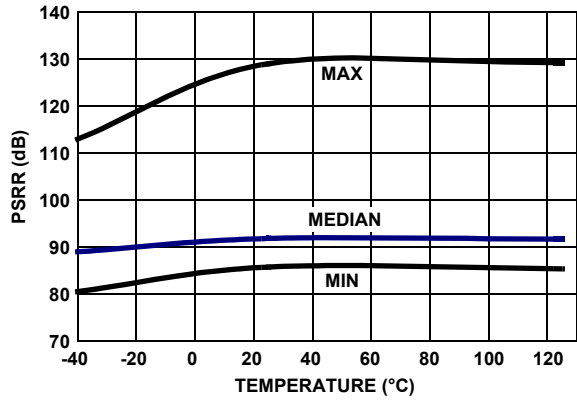

FIGURE 32. PSRR vs TEMPERATURE $V_+, V_- = \pm 1.2V$ TO $\pm 2.75V$

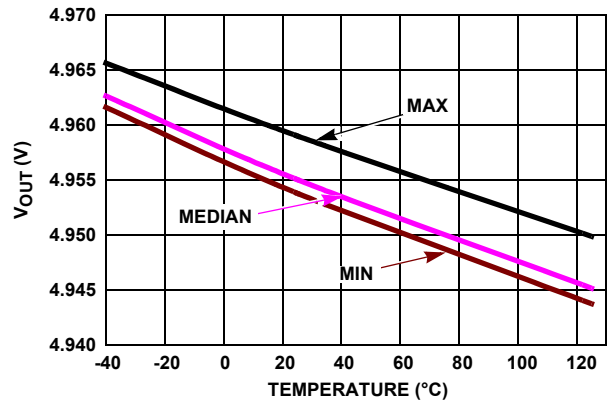

FIGURE 33. $V_{OUT HIGH}$ vs TEMPERATURE $R_L = 1k, V_+, V_- = \pm 2.5V$

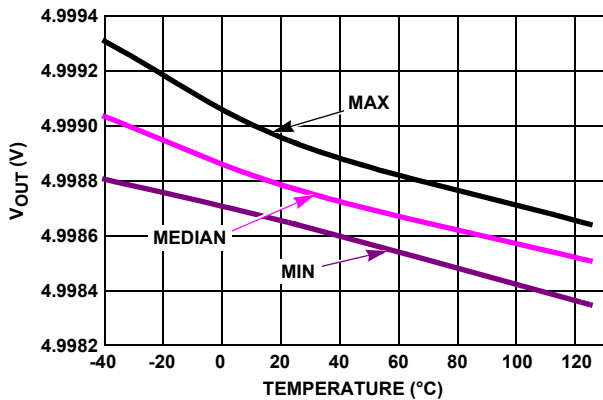

FIGURE 34. $V_{OUT HIGH}$ vs TEMPERATURE $R_L = 100k, V_+, V_- = \pm 2.5V$

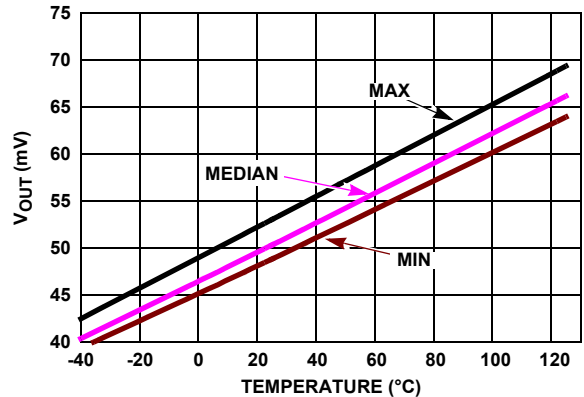

FIGURE 35. $V_{OUT LOW}$ vs TEMPERATURE $R_L = 1k, V_+, V_- = \pm 2.5V$

Typical Performance Curves $V_+ = 5V, V_- = 0V, V_{CM} = 2.5V, R_L = \text{Open. (Continued)}$

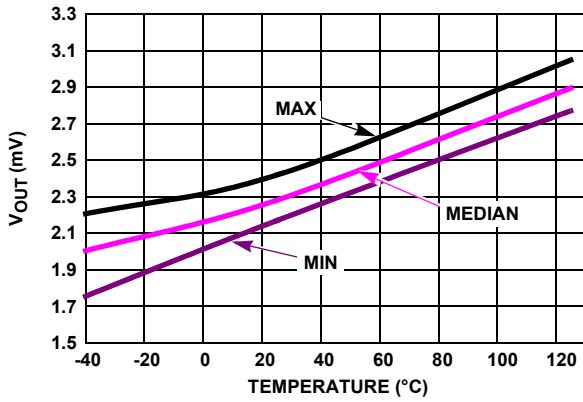

FIGURE 36. $V_{OUT\ LOW}$ vs TEMPERATURE $R_L = 100k, V_+, V_- = \pm 2.5V$

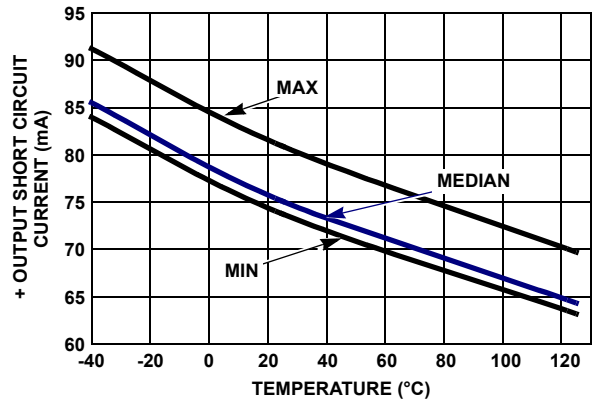

FIGURE 37. + OUTPUT SHORT CIRCUIT CURRENT vs TEMPERATURE $V_{IN} = 2.55V, R_L = 10, V_+, V_- = \pm 2.5V$

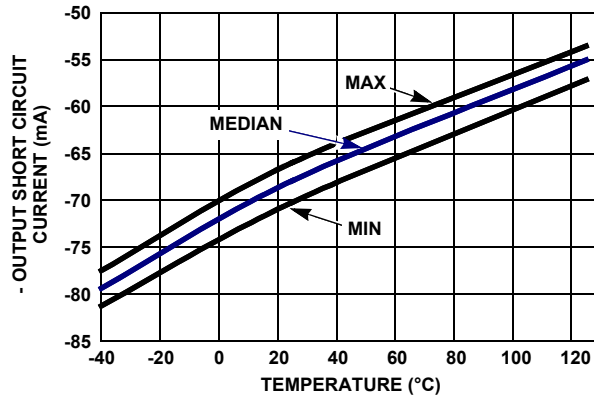

FIGURE 38. - OUTPUT SHORT CIRCUIT CURRENT vs TEMPERATURE $V_{IN} = -2.55V, R_L = 10, V_+, V_- = \pm 2.5V$

Applications Information

Introduction

The ISL28148, ISL28248 are single and dual channel CMOS rail-to-rail input, output (RRIO) micropower precision operational amplifiers. The parts are designed to operate from a single supply (2.4V to 5.5V) or a dual supply ($\pm 1.2V$ to $\pm 2.75V$). The parts have an input common-mode range that extends 0.25V above the positive rail and 100mV below the negative supply rail. The output can swing within about 3mV of the supply rails with a 100k Ω load.

Rail-to-Rail Input

Many rail-to-rail input stages use two differential input pairs, a long-tail PNP (or PFET) and an NPN (or NFET). Severe penalties have to be paid for this circuit topology. As the input signal moves from one supply rail to another, the operational amplifier switches from one input pair to the other causing drastic changes in input offset voltage and an undesired change in magnitude and polarity of input offset current.

The parts achieve input rail-to-rail operation without sacrificing important precision specifications and degrading distortion performance. The devices' input offset voltage exhibits a smooth behavior throughout the entire common-mode input range. The input bias current vs the common-mode voltage range gives us an undistorted behavior from typically 100mV below the negative rail and 0.25V higher than the V_+ rail.

Rail-to-Rail Output

A pair of complementary MOS devices are used to achieve the rail-to-rail output swing. The NMOS sinks current to swing the output in the negative direction. The PMOS sources current to swing the output in the positive direction. The devices' with a 100k Ω load will swing to within 3mV of the positive supply rail and within 3mV of the negative supply rail.

Results of Overdriving the Output

Caution should be used when overdriving the output for long periods of time. Overdriving the output can occur in two ways:

1. The input voltage times the gain of the amplifier exceeds the supply voltage by a large value or
2. The output current required is higher than the output stage can deliver. These conditions can result in a shift in the Input Offset Voltage (V_{OS}) as much as 1 μV /hr. of exposure under these conditions.

IN+ and IN- Input Protection

All input terminals have internal ESD protection diodes to both positive and negative supply rails, limiting the input voltage to within one diode beyond the supply rails. They also contain back-to-back diodes across the input terminals (see "Pin Descriptions" table - Circuit 1 on [page 2](#)). For applications where the input differential voltage is expected to exceed 0.5V, an external series resistor must be used to ensure the input currents never exceed 5mA ([Figure 39](#)).

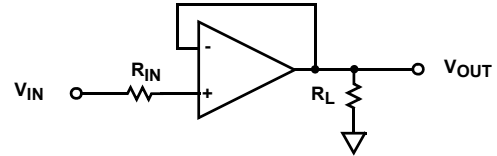

FIGURE 39. INPUT CURRENT LIMITING

Enable/Disable Feature

The ISL28148 offers an \overline{EN} pin that disables the device when pulled up to at least 2.0V. In the disabled state (output in a high impedance state), the part consumes typically 10 μA at room temperature. By disabling the part, multiple ISL28148 parts can be connected together as a MUX. In this configuration, the outputs are tied together in parallel and a channel can be selected by the \overline{EN} pin. The loading effects of the feedback resistors of the disabled amplifier must be considered when multiple amplifier outputs are connected together. Note that feed-through from the IN+ to IN- pins occurs on any Mux Amp disabled channel where the input differential voltage exceeds 0.5V (e.g., active channel $V_{OUT} = 1V$, while disabled channel $V_{IN} = GND$), so the Mux implementation is best suited for small signal applications. If large signals are required, use series IN+ resistors, or large value R_f , to keep the feed-through current low enough to minimize the impact on the active channel. See "[Limitations of the Differential Input Protection](#)" on [page 12](#) for more details. The \overline{EN} pin also has an internal pull-down. If left open, the \overline{EN} pin will pull to the negative rail and the device will be enabled by default. When not used, the \overline{EN} pin should either be left floating or connected directly to the V- pin.

Limitations of the Differential Input Protection

If the input differential voltage is expected to exceed 0.5V, an external current limiting resistor must be used to ensure the input current never exceeds 5mA. For noninverting unity gain applications the current limiting can be via a series IN+ resistor, or via a feedback resistor of appropriate value. For other gain configurations, the series IN+ resistor is the best choice, unless the feedback (R_f) and gain setting (R_g) resistors are both sufficiently large to limit the input current to 5mA.

Large differential input voltages can arise from several sources:

- During open loop (comparator) operation. Used this way, the IN+ and IN- voltages don't track, so differentials arise.
- When the amplifier is disabled but an input signal is still present. An R_L or R_g to GND keeps the IN- at GND, while the varying IN+ signal creates a differential voltage. Mux Amp applications are similar, except that the active channel V_{OUT} determines the voltage on the IN- terminal.
- When the slew rate of the input pulse is considerably faster than the op amp's slew rate. If the V_{OUT} cannot keep up with the IN+ signal, a differential voltage results and visible distortion occurs on the input and output signals. To avoid this issue, keep the input slew rate below 4.8V/ μs , or use appropriate current limiting resistors.

Large (>2V) differential input voltages can also cause an increase in disabled I_{CC} .

Using Only One Channel

If the application does not use all channels, then the user must configure the unused channel(s) to prevent them from oscillating. The unused channel(s) will oscillate if the input and output pins are floating. This will result in higher than expected supply currents and possible noise injection into the channel being used. The proper way to prevent this oscillation is to short the output to the negative input and ground the positive input (as shown in [Figure 40](#)).

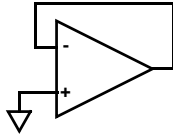

FIGURE 40. PREVENTING OSCILLATIONS IN UNUSED CHANNELS

Proper Layout Maximizes Performance

To achieve the maximum performance of the high input impedance and low offset voltage, care should be taken in the circuit board layout. The PC board surface must remain clean and free of moisture to avoid leakage currents between adjacent traces. Surface coating of the circuit board will reduce surface moisture and provide a humidity barrier, reducing parasitic resistance on the board. When input leakage current is a concern, the use of guard rings around the amplifier inputs will further reduce leakage currents. [Figure 41](#) shows a guard ring example for a unity gain amplifier that uses the low impedance amplifier output at the same voltage as the high impedance input to eliminate surface leakage. The guard ring does not need to be a specific width, but it should form a continuous loop around both inputs. For further reduction of leakage currents, components can be mounted to the PC board using Teflon standoff insulators.

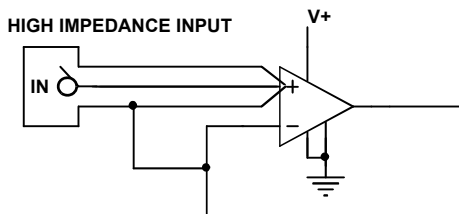

FIGURE 41. GUARD RING EXAMPLE FOR UNITY GAIN AMPLIFIER

Current Limiting

These devices have no internal current limiting circuitry. If the output is shorted, it is possible to exceed the absolute maximum rating for output current or power dissipation, potentially resulting in the destruction of the device.

Power Dissipation

It is possible to exceed the +150°C maximum junction temperatures under certain load and power-supply conditions. It is therefore important to calculate the maximum junction temperature (T_{JMAX}) for all applications to determine if power supply voltages, load conditions, or package type need to be modified to remain in the safe operating area. These parameters are related in [Equation 1](#):

$$T_{JMAX} = T_{MAX} + (\theta_{JA} \times PD_{MAXTOTAL}) \quad (EQ. 1)$$

Where:

- $PD_{MAXTOTAL}$ is the sum of the maximum power dissipation of each amplifier in the package (PD_{MAX})
- PD_{MAX} for each amplifier can be calculated as shown in [Equation 2](#):

$$PD_{MAX} = 2 \times V_S \times I_{SMAX} + (V_S - V_{OUTMAX}) \times \frac{V_{OUTMAX}}{R_L} \quad (EQ. 2)$$

Where:

- T_{MAX} = Maximum ambient temperature
- θ_{JA} = Thermal resistance of the package
- PD_{MAX} = Maximum power dissipation of 1 amplifier
- V_S = Supply voltage (Magnitude of V_+ and V_-)
- I_{MAX} = Maximum supply current of 1 amplifier
- V_{OUTMAX} = Maximum output voltage swing of the application
- R_L = Load resistance

Revision History

The revision history provided is for informational purposes only and is believed to be accurate, but not warranted. Please go to web to make sure you have the latest Rev.

| DATE | REVISION | CHANGE |
|------------------|----------|--|
| January 22, 2016 | FN6337.5 | <ul style="list-style-type: none"> -Removed part number ISL28448 throughout the datasheet. -Updated 3rd bullet under Features section. -Ordering information table on page 1: Added ISL28248MSOPEVAL1Z, ISL28248SOICEVAL1Z. -Electrical spec table on page 3, Changed VOS limits for the ISL28148: Min from -1.8, -2 to -2.3, -2.8 and Max from 1.8, 2 to 2.3, 2.8. Thermal Information table on page 3, changes are: <ul style="list-style-type: none"> 6ld SOT-23: from 230C/W, to 165C/W 8ld SOIC: from 125C/W, to 120C/W 8ld MSOP: from 175C/W, to 160C/W - Added revision history and About Intersil verbiage |

About Intersil

Intersil Corporation is a leading provider of innovative power management and precision analog solutions. The company's products address some of the largest markets within the industrial and infrastructure, mobile computing and high-end consumer markets.

For the most updated datasheet, application notes, related documentation and related parts, please see the respective product information page found at www.intersil.com.

You may report errors or suggestions for improving this datasheet by visiting www.intersil.com/ask.

Reliability reports are also available from our website at www.intersil.com/support

© Copyright Intersil Americas LLC 2007-2016. All Rights Reserved.
All trademarks and registered trademarks are the property of their respective owners.

For additional products, see www.intersil.com/en/products.html

Intersil products are manufactured, assembled and tested utilizing ISO9001 quality systems as noted in the quality certifications found at www.intersil.com/en/support/qualandreliability.html

Intersil products are sold by description only. Intersil may modify the circuit design and/or specifications of products at any time without notice, provided that such modification does not, in Intersil's sole judgment, affect the form, fit or function of the product. Accordingly, the reader is cautioned to verify that datasheets are current before placing orders. Information furnished by Intersil is believed to be accurate and reliable. However, no responsibility is assumed by Intersil or its subsidiaries for its use; nor for any infringements of patents or other rights of third parties which may result from its use. No license is granted by implication or otherwise under any patent or patent rights of Intersil or its subsidiaries.

For information regarding Intersil Corporation and its products, see www.intersil.com

Package Outline Drawing

P6.064A

6 LEAD SMALL OUTLINE TRANSISTOR PLASTIC PACKAGE

Rev 0, 2/10

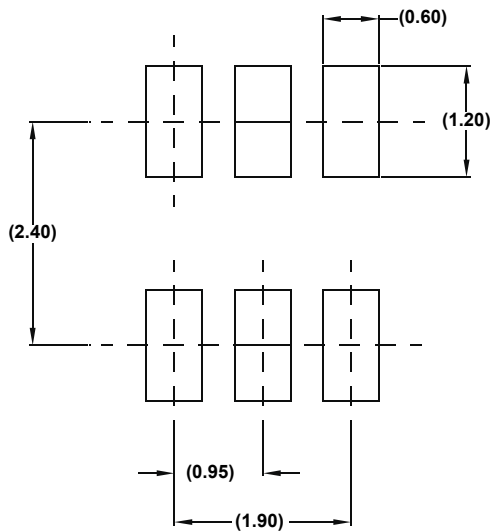
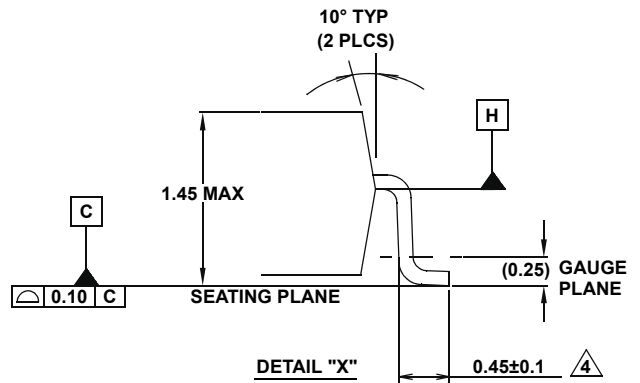
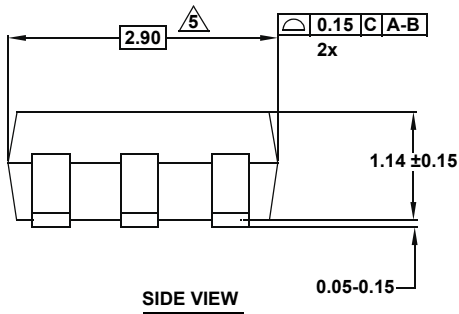
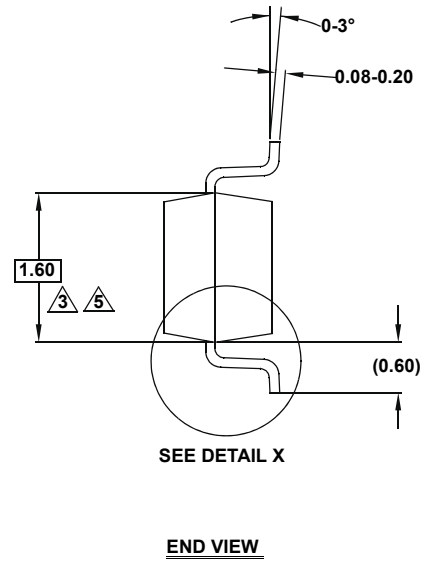
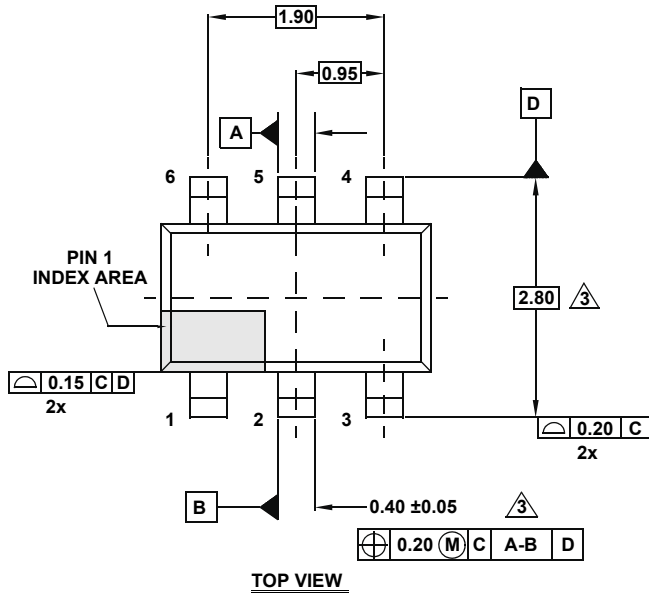

NOTES:

1. Dimensions are in millimeters.
Dimensions in () for Reference Only.
2. Dimensioning and tolerancing conform to ASME Y14.5M-1994.
3. Dimension is exclusive of mold flash, protrusions or gate burrs.
4. Foot length is measured at reference to gauge plane.
5. This dimension is measured at Datum "H".
6. Package conforms to JEDEC MO-178AA.

Package Outline Drawing

M8.15E

8 LEAD NARROW BODY SMALL OUTLINE PLASTIC PACKAGE

Rev 0, 08/09

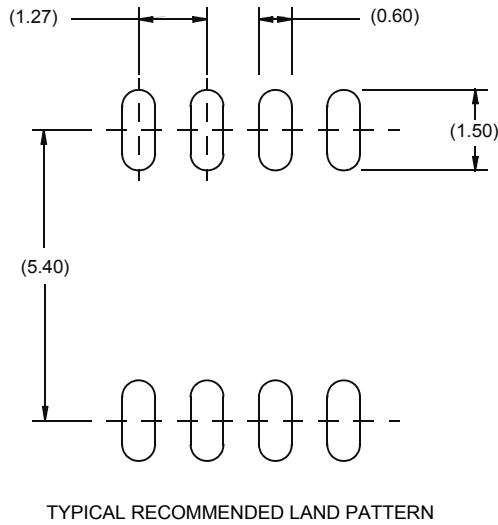
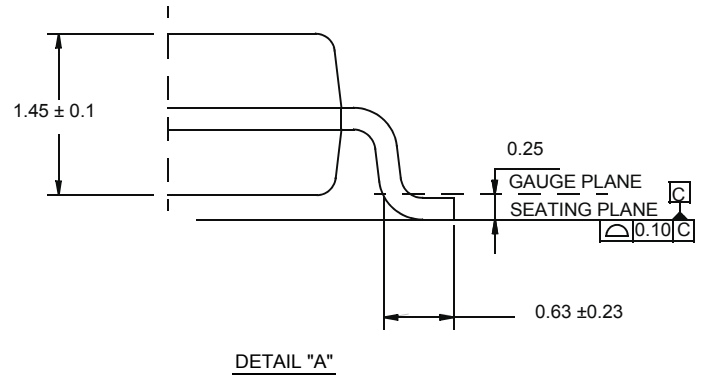
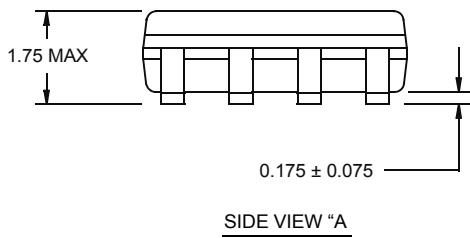
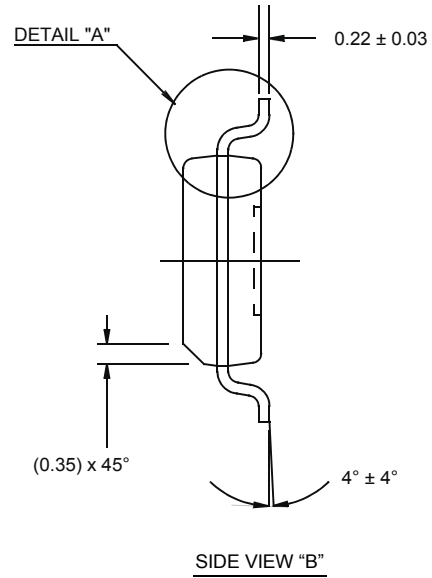
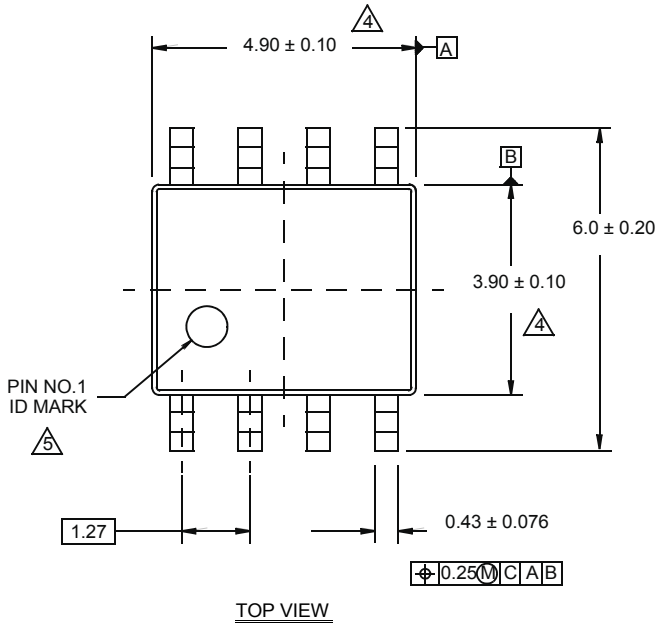

NOTES:

1. Dimensions are in millimeters.
Dimensions in () for Reference Only.
2. Dimensioning and tolerancing conform to AMSE Y14.5m-1994.
3. Unless otherwise specified, tolerance : Decimal ± 0.05
4. Dimension does not include interlead flash or protrusions.
Interlead flash or protrusions shall not exceed 0.25mm per side.
5. The pin #1 identifier may be either a mold or mark feature.
6. Reference to JEDEC MS-012.

Package Outline Drawing

M8.118A

8 LEAD MINI SMALL OUTLINE PLASTIC PACKAGE (MSOP)

Rev 0, 9/09

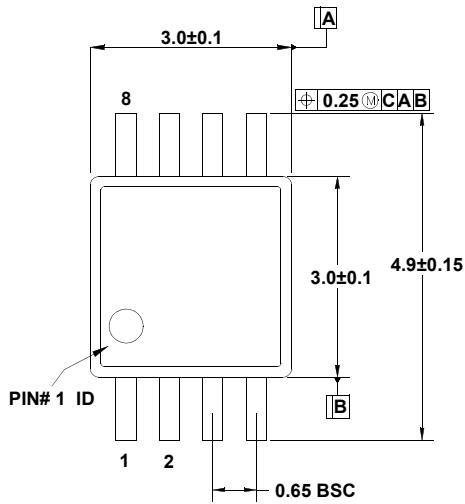

TOP VIEW

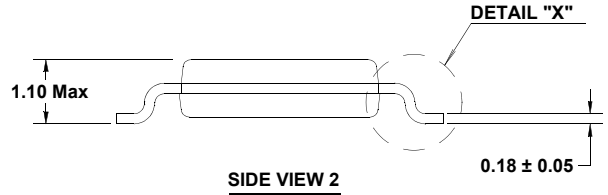

SIDE VIEW 2

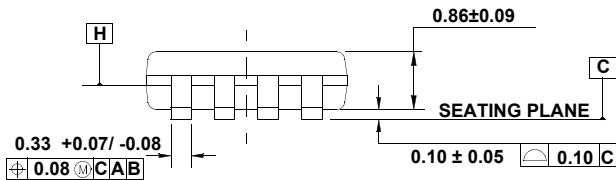

SIDE VIEW 1

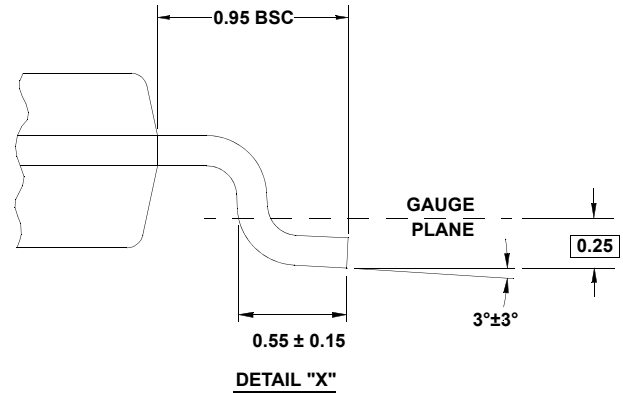

DETAIL "X"

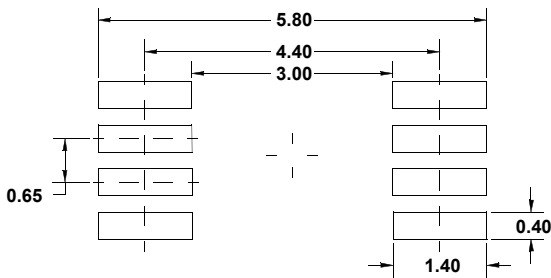

TYPICAL RECOMMENDED LAND PATTERN

NOTES:

1. Dimensions are in millimeters.
2. Dimensioning and tolerancing conform to JEDEC MO-187-AA and AMSE Y14.5m-1994.
3. Plastic or metal protrusions of 0.15mm max per side are not included.
4. Plastic interlead protrusions of 0.25mm max per side are not included.
5. Dimensions "D" and "E1" are measured at Datum Plane "H".
6. This replaces existing drawing # MDP0043 MSOP 8L.

X-ON Electronics

Largest Supplier of Electrical and Electronic Components

Click to view similar products for [Amplifier IC Development Tools](#) category:

Click to view products by [Renesas](#) manufacturer:

Other Similar products are found below :

[EVAL-ADCMP566BCPZ](#) [EVAL-ADCMP606BKSZ](#) [AD8013AR-14-EBZ](#) [AD8033AKS-EBZ](#) [AD8044AR-EBZ](#) [AD8225-EVALZ](#)
[ADA4859-3ACP-EBZ](#) [ADA4862-3YR-EBZ](#) [DEM-OPA-SO-2B](#) [AD744JR-EBZ](#) [AD8023AR-EBZ](#) [AD8030ARJ-EBZ](#) [AD8040ARU-EBZ](#)
[AD8073JR-EBZ](#) [AD813AR-14-EBZ](#) [AD848JR-EBZ](#) [ADA4858-3ACP-EBZ](#) [ADA4922-1ACP-EBZ](#) [551600075-001/NOPB](#) [DEM-OPA-SO-](#)
[2E](#) [THS7374EVM](#) [EVAL-ADCMP553BRMZ](#) [EVAL-ADCMP608BKSZ](#) [MIOP 42109](#) [EVAL-ADCMP609BRMZ](#) [MAX9928EVKIT+](#)
[MAX9636EVKIT+](#) [MAX9611EVKIT](#) [MAX9937EVKIT+](#) [MAX9934TEVKIT+](#) [MAX44290EVKIT#](#) [MAX2644EVKIT](#) [MAX2634EVKIT](#)
[MAX4073EVKIT+](#) [DEM-OPA-SO-2C](#) [MAX2643EVKIT](#) [ISL28158EVAL1Z](#) [MAX40003EVKIT#](#) [MAX2473EVKIT](#) [MAX2472EVKIT](#)
[MAX4223EVKIT](#) [MAX9700BEVKIT](#) [MADL-011014-001SMB](#) [DC1685A](#) [DEM-OPA-SO-2D](#) [MAX2670EVKIT#](#) [DEM-OPA-SO-1E](#)
[AD8137YCP-EBZ](#) [EVAL-ADA4523-1ARMZ](#) [MAX44242EVKIT#](#)