

ISL3179E, ISL3180E

High ESD Protected, +125°C, 40Mbps, 3.3V, Full Fail-Safe RS-485/RS-422 Transceivers

FN6365
Rev. 6.00
Nov 9, 2017

The [ISL3179E](#) and [ISL3180E](#) are high ESD protected (see [Table 2 on page 2](#)), 3.3V powered, single transceivers that meet both the RS-485 and RS-422 standards for balanced communication. Each device has low bus currents (+220µA/-150µA), so they present a “1/5 unit load” to the RS-485 bus. This allows up to 160 transceivers on the network without violating the RS-485 specification’s 32 unit load maximum, and without using repeaters.

Receiver (Rx) inputs feature a “full fail-safe” design, which ensures a logic high Rx output if Rx inputs are floating, shorted, or terminated but undriven.

The ISL3180E is configured for full duplex applications. The ISL3179E half duplex version multiplexes the Rx inputs and Tx outputs to allow a transceiver with an output disable function in 8 Ld packages.

Hot plug circuitry ensures that the Tx and Rx outputs remain in a high impedance state while the power supply stabilizes.

Related Literature

- For a full list of related documents, visit our website - [ISL3179E](#) and [ISL3180E](#) product pages

Applications

- Motor controller/position encoder systems
- Factory automation
- Field bus networks
- Security networks
- Building environmental control systems
- Industrial/process control networks

Features

- High ESD protection on RS-485 I/O pins
 - ISL3179E..... ±16.5kV IEC61000
 - ISL3180E ±12kV HBM
 - Class 3 HBM level on all other pins (ISL3179E)..... >9kV
- Specified for +125°C operation
- High data rates..... up to 40Mbps
- 5V tolerant logic inputs
- 1/5 unit load allows up to 160 devices on the bus
- Full fail-safe (open, shorted, terminated/undriven) receiver
- Hot plug - Tx and Rx outputs remain three-state during power-up
- Low quiescent current..... 4mA (max)
- Low current shutdown mode 1µA (max)
- -7V to +12V common-mode input voltage range
- Three-state Rx and Tx outputs
- 16/16.5ns (max) Tx/Rx propagation delays; 1.5ns (max) skew
- Operates from a single +3.3V supply (10% tolerance)
- Current limiting and thermal shutdown for driver overload protection
- Pb-free (RoHS compliant)

TABLE 1. KEY DIFFERENCES BETWEEN HIGH-SPEED INTERFACE FAMILY OF PARTS

| PART NUMBER | FULL/HALF DUPLEX | VCC (V) | VOD (V) | DATA RATE (Mbps) |
|-------------|------------------|---------|---------|------------------|
| ISL3179E | Half | 3.3 | 1.5 | 40 |
| ISL3180E | Full | 3.3 | 1.5 | 40 |
| ISL3159E | Half | 5 | 2.1 | 40 |
| ISL3259E | Half | 5 | 2.1 | 100 |



FIGURE 1. TYPICAL OPERATING CIRCUIT - ISL3179E

Ordering Information

| PART NUMBER (Note 4, 5) | PART MARKING | TEMP. RANGE (°C) | PACKAGE (RoHS Compliant) | PKG. DWG. # |
|--|--------------|---------------------|-----------------------------|-------------|
| ISL3179EFBZ (Note 1) | 3179 EFBZ | -40 to +125 | 8 Ld SOIC | M8.15 |
| ISL3179EFUZ (Note 1) | 179FZ | -40 to +125 | 8 Ld MSOP | M8.118 |
| ISL3179EFRZ (Note 2) | 79FZ | -40 to +125 | 10 Ld DFN | L10.3x3C |
| ISL3179EIBZ (Note 1) | 3179 EIBZ | -40 to +85 | 8 Ld SOIC | M8.15 |
| ISL3179EIUZ (Note 1) | 179IZ | -40 to +85 | 8 Ld MSOP | M8.118 |
| ISL3179EIRZ (Note 2) | 79IZ | -40 to +85 | 10 Ld DFN | L10.3x3C |
| ISL3180EIBZ (Note 3) | ISL3180 EIBZ | -40 to +85 | 14 Ld SOIC | M14.15 |

NOTES:

1. Add "-T" suffix for 2.5k unit tape or "-T7A" suffix for 250 unit tape and reel options. Refer to [TB347](#) for details on reel specifications.
2. Add "-T" suffix for 6k unit tape or "-T7A" suffix for 250 unit tape and reel options. Refer to [TB347](#) for details on reel specifications.
3. Add "-T" suffix for 2.5k unit tape and reel options. Refer to [TB347](#) for details on reel specifications.
4. Intersil Pb-free plastic packaged products employ special Pb-free material sets, molding compounds/die attach materials, and 100% matte tin plate plus anneal (e3 termination finish, which is RoHS compliant and compatible with both SnPb and Pb-free soldering operations). Intersil Pb-free products are MSL classified at Pb-free peak reflow temperatures that meet or exceed the Pb-free requirements of IPC/JEDEC J STD-020.
5. For Moisture Sensitivity Level (MSL), refer to the product information page for the [ISL3179E](#) and the [ISL3180E](#). For more information about MSL, refer to [TB363](#).

TABLE 2. SUMMARY OF FEATURES

| PART NUMBER | HALF/FULL DUPLEX | DATA RATE (Mbps) | RS-485 PIN ESD LEVEL | HOT PLUG? | RX/TX ENABLE? | QUIESCENT I _{CC} (mA) | LOW POWER SHUTDOWN? | PIN COUNT |
|-------------|------------------|------------------|----------------------|-----------|---------------|--------------------------------|---------------------|-----------|
| ISL3179E | HALF | 40 | 16.5kV IEC61000 | YES | YES | 2.6 | YES | 8, 10 |
| ISL3180E | FULL | 40 | 12kV HBM | YES | YES | 2.6 | YES | 14 |

Pin Configurations



Truth Table

| TRANSMITTING | | | | |
|-----------------|----|----|---------|---------|
| INPUTS | | | OUTPUTS | |
| \overline{RE} | DE | DI | B/Z | A/Y |
| X | 1 | 1 | 0 | 1 |
| X | 1 | 0 | 1 | 0 |
| 0 | 0 | X | High-Z | High-Z |
| 1 | 0 | X | High-Z* | High-Z* |

NOTE: *Shutdown Mode

Truth Table

| RECEIVING | | | | |
|-----------------|----------------|----------------|---------------------------|--------------|
| INPUTS | | | | OUTPUT |
| \overline{RE} | DE Half Duplex | DE Full Duplex | A-B | RO |
| 0 | 0 | X | $V_{AB} \geq -0.05V$ | 1 |
| 0 | 0 | X | $-0.05V > V_{AB} > -0.2V$ | Undetermined |
| 0 | 0 | X | $V_{AB} \leq -0.2V$ | 0 |
| 0 | 0 | X | Inputs Open/Shorted | 1 |
| 1 | 0 | X | X | High-Z* |
| 1 | 1 | X | X | High-Z |

NOTE: *Shutdown Mode

Pin Descriptions

| PIN | FUNCTION |
|-----------------|---|
| RO | Receiver output: If A-B \geq -50mV, RO is high; If A-B \leq -200mV, RO is low; If A and B are unconnected (floating) or shorted, or connected to a terminated bus that is undriven, RO is high. |
| \overline{RE} | Receiver output enable. RO is enabled when \overline{RE} is low; RO is high impedance when \overline{RE} is high. If the Rx enable function isn't required, connect \overline{RE} directly to GND. |
| DE | Driver output enable. The driver outputs, Y and Z, are enabled by bringing DE high, and they are high impedance when DE is low. If the Tx enable function is not required, connect DE to V _{CC} through a 1k Ω or greater resistor. |
| DI | Driver input. A low on DI forces output Y low and output Z high. Similarly, a high on DI forces output Y high and output Z low. |
| GND | Ground connection. This is also the potential of the DFN's exposed metal pad. |
| A/Y | $\pm 16.5kV$ IEC61000 ESD protected RS-485/RS-422 level, noninverting receiver input and noninverting driver output. Pin is an input (A) if DE = 0; pin is an output (Y) if DE = 1. ISL3179E only. |
| B/Z | $\pm 16.5kV$ IEC61000 ESD protected RS-485/RS-422 level, inverting receiver input and inverting driver output. Pin is an input (B) if DE = 0; pin is an output (Z) if DE = 1. ISL3179E only. |
| A | $\pm 12kV$ HBM ESD protected RS-485/RS-422 level, noninverting receiver input. ISL3180E only. |
| B | $\pm 12kV$ HBM ESD protected RS-485/RS-422 level, inverting receiver input. ISL3180E only. |
| Y | $\pm 12kV$ HBM ESD protected RS-485/RS-422 level, noninverting driver output. ISL3180E only. |
| Z | $\pm 12kV$ HBM ESD protected RS-485/RS-422 level, inverting driver output. ISL3180E only. |
| V _{CC} | System power supply input (3.0V to 3.6V). |
| NC | No internal connection. |
| EP | The exposed metal pad on the bottom of the DFN; connect to GND. |

Typical Operating Circuits

(SOIC AND MSOP PIN NUMBERS SHOWN)



FIGURE 2. ISL3179E

(PIN NUMBERS FOR SOIC)



FIGURE 3. ISL3180E

Absolute Maximum Ratings

| | |
|---------------------------|--------------------------------------|
| V _{CC} to Ground | 7V |
| Input Voltages | |
| DI, DE, \overline{RE} | -0.3V to 7V |
| Input/Output Voltages | |
| A, B, Y, Z, A/Y, B/Z | -9V to +13V |
| RO | -0.3V to (V _{CC} + 0.3V) |
| Short-circuit Duration | |
| Y, Z | Continuous |
| ESD Rating | Refer to "Electrical Specifications" |

Thermal Information

| | | |
|--|--------------------------------|----------------------|
| Thermal Resistance (Typical) | θ_{JA} (°C/W) | θ_{JC} (°C/W) |
| 8 Ld SOIC Package (Note 6) | 160 | N/A |
| 14 Ld SOIC Package (Note 6) | 91 | N/A |
| 8 Ld MSOP Package (Note 6) | 132.5 | N/A |
| 10 Ld DFN Package (Notes 7, 8) | 46 | 3.5 |
| Maximum Junction Temperature (Plastic Package) | +150°C | |
| Maximum Storage Temperature Range | -65°C to +150°C | |
| Pb-free Reflow Profile | Refer to TB493 | |

Operating Conditions

| | |
|----------------------|-----------------|
| Temperature Range | |
| ISL3179EF | -40°C to +125°C |
| ISL3179EI, ISL3180EI | -40°C to +85°C |

CAUTION: Do not operate at or near the maximum ratings listed for extended periods of time. Exposure to such conditions may adversely impact product reliability and result in failures not covered by warranty.

NOTES:

- θ_{JA} is measured with the component mounted on a high-effective thermal conductivity test board in free air. Refer to [TB379](#) for details.
- For θ_{JC} , the "case temp" location is the center of the exposed metal pad on the package underside.
- θ_{JA} is measured in free air with the component mounted on a high-effective thermal conductivity test board with "direct attach" features. Refer to [TB379](#) for details.

Electrical Specifications Test Conditions: V_{CC} = 3.0V to 3.6V; Typicals are at V_{CC} = 3.3V, T_A = +25°C. **Boldface limits apply across the operating temperature range.** (Note 9)

| PARAMETER | SYMBOL | TEST CONDITIONS | TEMP (°C) | MIN (Note 19) | TYP | MAX (Note 19) | UNIT | |
|---|-------------------|---|-----------------------|-----------------------------|-------------|-----------------|------------|----|
| DC CHARACTERISTICS | | | | | | | | |
| Driver Differential V _{OUT} | V _{OD} | R _L = 100Ω (RS-422) (Figure 4A), (Note 18) | Full | 2 | 2.3 | - | V | |
| | | R _L = 54Ω (RS-485) (Figure 4A) | Full | 1.5 | 2.1 | V _{CC} | V | |
| | | No load | Full | - | - | V _{CC} | | |
| | | R _L = 60Ω, -7V ≤ V _{CM} ≤ 12V (Figure 4B), (Note 18) | Full | 1.5 | 2 | - | V | |
| Change in Magnitude of Driver Differential V _{OUT} for Complementary Output States | ΔV _{OD} | R _L = 54Ω or 100Ω (Figure 4A) | Full | - | 0.01 | 0.2 | V | |
| Driver Common-Mode V _{OUT} | V _{OC} | R _L = 54Ω or 100Ω (Figure 4A) | Full | - | 2 | 2.5 | V | |
| Change in Magnitude of Driver Common-Mode V _{OUT} for Complementary Output States | ΔV _{OC} | R _L = 54Ω or 100Ω (Figure 4A) | Full | - | 0.02 | 0.2 | V | |
| Logic Input High Voltage | V _{IH} | DI, DE, \overline{RE} | Full | 2 | - | - | V | |
| Logic Input Low Voltage | V _{IL} | DI, DE, \overline{RE} | Full | - | - | 0.8 | V | |
| Logic Input Current | I _{IN1} | DI = DE = \overline{RE} = 0V or V _{CC} | Full | -2 | - | 2 | μA | |
| Input Current (A, B, A/Y, B/Z) | I _{IN2} | DE = 0V, V _{CC} = 0V or 3.6V | V _{IN} = 12V | Full | - | - | 220 | μA |
| | | | V _{IN} = -7V | Full | -160 | - | - | μA |
| Y or Z Output Leakage Current | I _{OZ} | DE = 0V, -7V ≤ V _Y or V _Z ≤ 12V, ISL3180E only | Full | -40 | - | 40 | μA | |
| Driver Short-Circuit Current, V _O = High or Low | I _{OSD1} | DE = V _{CC} , -7V ≤ V _Y or V _Z ≤ 12V (Note 11) | Full | - | - | ±250 | mA | |
| Receiver Differential Threshold Voltage | V _{TH} | -7V ≤ V _{CM} ≤ 12V | Full | -200 | - | -50 | mV | |
| Receiver Input Hysteresis | ΔV _{TH} | V _{CM} = 0V | 25 | - | 28 | - | mV | |
| Receiver Output High Voltage | V _{OH} | I _O = -12mA, V _{ID} = -50mV | Full | V_{CC} - 0.5 | - | - | V | |

Electrical Specifications Test Conditions: $V_{CC} = 3.0V$ to $3.6V$; Typical are at $V_{CC} = 3.3V$, $T_A = +25^\circ C$. **Boldface limits apply across the operating temperature range.** (Note 9) (Continued)

| PARAMETER | SYMBOL | TEST CONDITIONS | TEMP (°C) | MIN (Note 19) | TYP | MAX (Note 19) | UNIT |
|---|--------------------|---|--------------|----------------------------|-------------|-----------------------------|------------|
| Receiver Output Low Voltage | V_{OL} | $I_O = +10mA$, $V_{ID} = -200mV$ | Full | - | - | 0.4 | V |
| Receiver Output Low Current | I_{OL} | $V_{OL} = 1V$, $V_{ID} = -200mV$ | Full | 25 | - | - | mA |
| Three-State (high impedance) Receiver Output Current | I_{OZR} | $0.4V \leq V_O \leq 2.4V$ | Full | -1 | 0.015 | 1 | μA |
| Receiver Input Resistance | R_{IN} | $-7V \leq V_{CM} \leq 12V$ | Full | 54 | 80 | - | k Ω |
| Receiver Short-Circuit Current | I_{OSR} | $0V \leq V_O \leq V_{CC}$ | Full | ± 20 | - | ± 110 | mA |
| SUPPLY CURRENT | | | | | | | |
| No-Load Supply Current (Note 10) | I_{CC} | $DI = DE = 0V$ or V_{CC} | Full | - | 2.6 | 4 | mA |
| Shutdown Supply Current | I_{SHDN} | $DE = 0V$, $\overline{RE} = V_{CC}$, $DI = 0V$ or V_{CC} | Full | - | 0.05 | 1 | μA |
| ESD PERFORMANCE | | | | | | | |
| RS-485 Pins (A/Y, B/Z) ISL3179E Only | | IEC61000-4-2, Air-gap Discharge Method | 25 | - | ± 16.5 | - | kV |
| | | IEC61000-4-2, Contact Discharge Method | 25 | - | ± 9 | - | kV |
| | | Human Body Model, from bus pins to GND | 25 | - | ± 16.5 | - | kV |
| All Pins ISL3179E Only | | Human Body Model, per JEDEC | 25 | - | $> \pm 9$ | - | kV |
| | | Machine Model, per JEDEC | 25 | - | $> \pm 400$ | - | V |
| RS-485 Pins (A, B, Y, Z) ISL3180E Only | | IEC61000-4-2, Air-gap Discharge Method | 25 | - | ± 4 | - | kV |
| | | IEC61000-4-2, Contact Discharge Method | 25 | - | ± 5 | - | kV |
| | | Human Body Model, from bus pins to GND | 25 | - | ± 12 | - | kV |
| All Pins ISL3180E Only | | Human Body Model, per JEDEC | 25 | - | ± 3 | - | kV |
| | | Machine Model, per JEDEC | 25 | - | ± 150 | - | V |
| DRIVER SWITCHING CHARACTERISTICS | | | | | | | |
| Maximum Data Rate | f_{MAX} | $V_{OD} \geq \pm 1.5V$, $R_D = 54\Omega$, $C_L = 100pF$ (Figure 7) | Full | 40 | 60 | - | Mbps |
| Driver Differential Output Delay | t_{DD} | $R_D = 54\Omega$, $C_D = 50pF$ (Figure 5) | Full | - | 11 | 16 | ns |
| Prop Delay Part-to-Part Skew | t_{SKP-P} | $R_D = 54\Omega$, $C_D = 50pF$ (Figure 5), (Note 17) | Full | - | - | 4 | ns |
| Driver Differential Output Skew | t_{SKEW} | $R_D = 54\Omega$, $C_D = 50pF$ (Figure 5) | Full | - | 0 | 1.5 | ns |
| Driver Differential Rise or Fall Time | t_R, t_F | $R_D = 54\Omega$, $C_D = 50pF$ (Figure 5) | Full | - | 4 | 7 | ns |
| Driver Enable to Output High | t_{ZH} | $R_L = 110\Omega$, $C_L = 50pF$, $SW = GND$ (Figure 6), (Note 12) | Full | - | 18 | 25 | ns |
| Driver Enable to Output Low | t_{ZL} | $R_L = 110\Omega$, $C_L = 50pF$, $SW = V_{CC}$ (Figure 6), (Note 12) | Full | - | 16 | 25 | ns |
| Driver Disable from Output High | t_{HZ} | $R_L = 110\Omega$, $C_L = 50pF$, $SW = GND$ (Figure 6) | Full | - | 15 | 25 | ns |
| Driver Disable from Output Low | t_{LZ} | $R_L = 110\Omega$, $C_L = 50pF$, $SW = V_{CC}$ (Figure 6) | Full | - | 18 | 25 | ns |
| Time to Shutdown | t_{SHDN} | (Note 14) | Full | 60 | - | 600 | ns |
| Driver Enable from Shutdown to Output High | $t_{ZH(SHDN)}$ | $R_L = 110\Omega$, $C_L = 50pF$, $SW = GND$ (Figure 6), (Notes 14, 15) | Full | - | - | 1000 | ns |
| Driver Enable from Shutdown to Output Low | $t_{ZL(SHDN)}$ | $R_L = 110\Omega$, $C_L = 50pF$, $SW = V_{CC}$ (Figure 6), (Notes 14, 15) | Full | - | - | 1000 | ns |
| RECEIVER SWITCHING CHARACTERISTICS | | | | | | | |
| Maximum Data Rate | f_{MAX} | $V_{ID} = \pm 1.5V$ | Full | 40 | 60 | - | Mbps |
| Receiver Input to Output Delay | t_{PLH}, t_{PHL} | Figure 8 | Full | - | 10 | 16.5 | ns |
| Prop Delay Part-to-Part Skew | t_{SKP-P} | Figure 8, Note 17 | Full | - | - | 4 | ns |

Electrical Specifications Test Conditions: $V_{CC} = 3.0V$ to $3.6V$; Typicals are at $V_{CC} = 3.3V$, $T_A = +25^\circ C$. **Boldface limits apply across the operating temperature range.** (Note 9) (Continued)

| PARAMETER | SYMBOL | TEST CONDITIONS | TEMP (°C) | MIN (Note 19) | TYP | MAX (Note 19) | UNIT |
|--|----------------|--|-----------|---------------|-----|---------------|------|
| Receiver Skew $t_{PLH} - t_{PHL}$ | t_{SKD} | Figure 8 | Full | - | 0 | 1.5 | ns |
| Receiver Enable to Output High | t_{ZH} | $R_L = 1k\Omega$, $C_L = 15pF$, SW = GND (Figure 9), (Note 13) | Full | - | 10 | 15 | ns |
| Receiver Enable to Output Low | t_{ZL} | $R_L = 1k\Omega$, $C_L = 15pF$, SW = V_{CC} (Figure 9), (Note 13) | Full | - | 11 | 15 | ns |
| Receiver Disable from Output High | t_{HZ} | $R_L = 1k\Omega$, $C_L = 15pF$, SW = GND (Figure 9) | Full | - | 10 | 15 | ns |
| Receiver Disable from Output Low | t_{LZ} | $R_L = 1k\Omega$, $C_L = 15pF$, SW = V_{CC} (Figure 9) | Full | - | 10 | 15 | ns |
| Time to Shutdown | t_{SHDN} | (Note 14) | Full | 60 | - | 600 | ns |
| Receiver Enable from Shutdown to Output High | $t_{ZH(SHDN)}$ | $R_L = 1k\Omega$, $C_L = 15pF$, SW = GND (Figure 9), (Notes 14, 16) | Full | - | - | 1000 | ns |
| Receiver Enable from Shutdown to Output Low | $t_{ZL(SHDN)}$ | $R_L = 1k\Omega$, $C_L = 15pF$, SW = V_{CC} (Figure 9), (Notes 14, 16) | Full | - | - | 1000 | ns |

NOTES:

- All currents into device pins are positive; all currents out of device pins are negative. All voltages are referenced to device ground unless otherwise specified.
- Supply current specification is valid for loaded drivers when $DE = 0V$.
- Applies to peak current. Refer to "Typical Performance Curves" on page 9 for more information.
- Because of the shutdown feature, keep $\overline{RE} = 0$ to prevent the device from entering SHDN.
- Because of the shutdown feature, the \overline{RE} signal high time must be short enough (typically <100ns) to prevent the device from entering SHDN.
- These ICs are put into shutdown by bringing \overline{RE} high and DE low. If the inputs are in this state for less than 60ns, the parts are guaranteed not to enter shutdown. If the inputs are in this state for at least 700ns, the parts are guaranteed to have entered shutdown. Refer to "Low Power Shutdown Mode" on page 13.
- Keep $\overline{RE} = V_{CC}$, and set the DE signal low time >700ns to ensure that the device enters SHDN.
- Set the \overline{RE} signal high time >700ns to ensure that the device enters SHDN.
- This is the part-to-part skew between any two units tested with identical test conditions (Temperature, V_{CC} , etc.).
- $V_{CC} = 3.3V \pm 5\%$.
- Compliance to datasheet limits is assured by one or more methods: production test, characterization, and/or design.

Test Circuits and Waveforms



FIGURE 4A. V_{OD} AND V_{OC}



FIGURE 4B. V_{OD} WITH COMMON-MODE LOAD

FIGURE 4. DC DRIVER TEST CIRCUITS

Test Circuits and Waveforms (Continued)



FIGURE 5A. TEST CIRCUIT



FIGURE 5B. MEASUREMENT POINTS

FIGURE 5. DRIVER PROPAGATION DELAY AND DIFFERENTIAL TRANSITION TIMES



| PARAMETER | OUTPUT | \overline{RE} | DI | SW |
|----------------|--------|-----------------|-----|----------|
| t_{HZ} | Y/Z | X | 1/0 | GND |
| t_{LZ} | Y/Z | X | 0/1 | V_{CC} |
| t_{ZH} | Y/Z | 0 (Note 12) | 1/0 | GND |
| t_{ZL} | Y/Z | 0 (Note 12) | 0/1 | V_{CC} |
| $t_{ZH(SHDN)}$ | Y/Z | 1 (Note 15) | 1/0 | GND |
| $t_{ZL(SHDN)}$ | Y/Z | 1 (Note 15) | 0/1 | V_{CC} |

FIGURE 6A. TEST CIRCUIT



FIGURE 6B. MEASUREMENT POINTS

FIGURE 6. DRIVER ENABLE AND DISABLE TIMES



FIGURE 7A. TEST CIRCUIT



FIGURE 7B. MEASUREMENT POINTS

FIGURE 7. DRIVER DATA RATE

Test Circuits and Waveforms (Continued)



FIGURE 8A. TEST CIRCUIT



FIGURE 8B. MEASUREMENT POINTS

FIGURE 8. RECEIVER PROPAGATION DELAY



FIGURE 9A. TEST CIRCUIT

| PARAMETER | DE | A | SW |
|--------------------------|----|-------|----------|
| t_{HZ} | 0 | +1.5V | GND |
| t_{LZ} | 0 | -1.5V | V_{CC} |
| t_{ZH} (Note 13) | 0 | +1.5V | GND |
| t_{ZL} (Note 13) | 0 | -1.5V | V_{CC} |
| $t_{ZH(SHDN)}$ (Note 16) | 0 | +1.5V | GND |
| $t_{ZL(SHDN)}$ (Note 16) | 0 | -1.5V | V_{CC} |

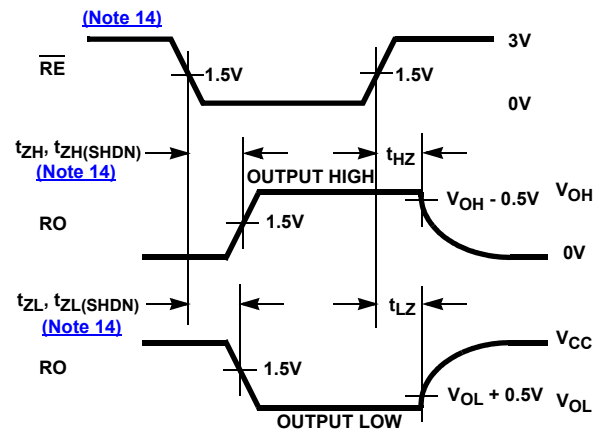

FIGURE 9B. MEASUREMENT POINTS

FIGURE 9. RECEIVER ENABLE AND DISABLE TIMES

Typical Performance Curves

$V_{CC} = 3.3V$, $T_A = +25^\circ C$; unless otherwise specified



FIGURE 10. DRIVER OUTPUT CURRENT vs DIFFERENTIAL OUTPUT VOLTAGE



FIGURE 11. DRIVER DIFFERENTIAL OUTPUT VOLTAGE vs TEMPERATURE

Typical Performance Curves $V_{CC} = 3.3V, T_A = +25^\circ C$; unless otherwise specified (Continued)



FIGURE 12. DRIVER OUTPUT CURRENT vs SHORT-CIRCUIT VOLTAGE



FIGURE 13. SUPPLY CURRENT vs TEMPERATURE



FIGURE 14. DRIVER DIFFERENTIAL PROPAGATION DELAY vs TEMPERATURE



FIGURE 15. DRIVER DIFFERENTIAL SKEW vs TEMPERATURE



FIGURE 16. DRIVER AND RECEIVER WAVEFORMS

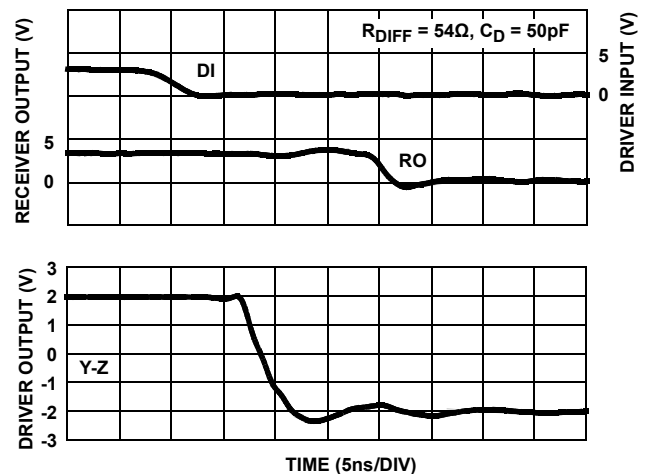

FIGURE 17. DRIVER AND RECEIVER WAVEFORMS

Typical Performance Curves $V_{CC} = 3.3V, T_A = +25^\circ C$; unless otherwise specified (Continued)



FIGURE 18. DRIVER AND RECEIVER WAVEFORMS DRIVING 100' (31m) OF CAT5 CABLE (DOUBLE TERMINATED WITH 120Ω)



FIGURE 19. DRIVER AND RECEIVER WAVEFORMS DRIVING 500' (152m) OF CAT5 CABLE (DOUBLE TERMINATED WITH 120Ω)



FIGURE 20. RECEIVER OUTPUT CURRENT vs RECEIVER OUTPUT VOLTAGE

Die Characteristics

SUBSTRATE AND DFN THERMAL PAD POTENTIAL (POWERED UP):

GND

PROCESS:

Si Gate BiCMOS

Application Information

RS-485 and RS-422 are differential (balanced) data transmission standards for use in long haul or noisy environments. RS-422 is a subset of RS-485, so RS-485 transceivers are also RS-422 compliant. RS-422 is a point-to-multipoint (multidrop) standard, which allows only one driver and up to 10 receivers on each bus, assuming one unit load devices. RS-485 is a true multipoint standard, which allows up to 32 one unit load devices (any mix of drivers and receivers) on each bus. To allow for multipoint operation, the RS-485 specification requires that drivers must handle bus contention without sustaining any damage.

Another important advantage of RS-485 is the extended common-mode range (CMR), which specifies that the driver outputs and receiver inputs withstand signals that range from +12V to -7V. RS-422 and RS-485 are intended for cable lengths as long as 4000ft (~1200m), so the wide CMR is necessary to handle ground potential differences, as well as voltages induced in the cable by external fields.

Receiver (Rx) Features

This transceiver utilizes a differential input receiver for maximum noise immunity and common-mode rejection. Input sensitivity is $\pm 200\text{mV}$, as required by the RS-422 and RS-485 specifications. Receiver inputs function with common-mode voltages as great as +9/-7V outside the power supplies (+12V and -7V), making them ideal for long networks, or industrial environments, where induced voltages are a realistic concern.

The receiver input resistance of 50k Ω surpasses the RS-422 specification of 4k Ω , and is five times the RS-485 "Unit Load" (UL) requirement of 12k Ω minimum. Thus, the ISL3179E is known as a "one-fifth UL" transceiver, and there can be up to 160 devices on the RS-485 bus while still complying with the RS-485 loading specification.

The receiver is a "full fail-safe" version that guarantees a high level receiver output if the receiver inputs are unconnected (floating), shorted together, or connected to a terminated bus with all the transmitters disabled (terminated/undriven).

Rx outputs deliver large low state currents (typically 28mA at $V_{OL} = 1\text{V}$) to ease the design of optically coupled isolated networks.

Receivers easily meet the 40Mbps data rate supported by the driver, and the receiver output is tri-statable through the active low \overline{RE} input.

Driver (Tx) Features

The RS-485/RS-422 driver is a differential output device that delivers at least 1.5V across a 54 Ω load (RS-485), and at least 2V across a 100 Ω load (RS-422). The drivers feature low propagation delay skew to maximize bit width and to minimize EMI.

Driver outputs are not slew rate limited, so faster output transition times allow data rates of at least 40Mbps. Driver outputs are tri-statable through the active high DE input.

For parallel applications, bit-to-bit skews between any two transmitter and receiver pairs are guaranteed to be no worse than 8ns (4ns max for any two Tx, 4ns max for any two Rx).

ESD Protection

All pins on the ISL3179E include Class 3 (>9kV) Human Body Model (HBM) ESD protection structures, but the RS-485 pins (driver outputs and receiver inputs) incorporate advanced structures allowing them to survive ESD events in excess of $\pm 16.5\text{kV}$ HBM (ISL3179E) or $\pm 12\text{kV}$ HBM (ISL3180E), and $\pm 16.5\text{kV}$ (ISL3179E) or $\pm 4\text{kV}$ (ISL3180E) IEC61000-4-2. The RS-485 pins are particularly vulnerable to ESD strikes because they typically connect to an exposed port on the exterior of the finished product. Simply touching the port pins, or connecting a cable, can cause an ESD event that can destroy unprotected ICs. These new ESD structures protect the device whether or not it is powered up, and without degrading the RS-485 common-mode range of -7V to +12V. This built-in ESD protection eliminates the need for board level protection structures (for example, transient suppression diodes) and the associated, undesirable capacitive load they present.

IEC61000-4-2 Testing

The IEC61000 test method applies to finished equipment, rather than to an individual IC. Therefore, the pins most likely to suffer an ESD event are those that are exposed to the outside world (the RS-485 pins in this case), and the IC is tested in its typical application configuration (power applied) rather than testing each pin-to-pin combination. The IEC61000 standard's lower current limiting resistor coupled with the larger charge storage capacitor yields a test that is much more severe than the HBM test. The extra ESD protection built into the ISL3179E's RS-485 pins allows the design of equipment meeting Level 4 criteria without the need for additional board level protection on the RS-485 port.

AIR-GAP DISCHARGE TEST METHOD

For this test method, a charged probe tip moves toward the IC pin until the voltage arcs to it. The current waveform delivered to the IC pin depends on approach speed, humidity, temperature, etc., so it is more difficult to obtain repeatable results. The ISL3179E RS-485 pins withstand $\pm 16.5\text{kV}$ air-gap discharges, while the ISL3180E RS-485 pins withstand $\pm 4\text{kV}$.

CONTACT DISCHARGE TEST METHOD

During the contact discharge test, the probe contacts the tested pin before the probe tip is energized, thereby eliminating the variables associated with the air-gap discharge. The result is a more repeatable and predictable test, but equipment limits prevent testing devices at voltages higher than $\pm 9\text{kV}$. The RS-485 pins of the ISL3179E survive $\pm 9\text{kV}$ contact discharges, while the ISL3180E's RS-485 pins withstand $\pm 5\text{kV}$.

Hot Plug Function

When a piece of equipment powers up, a period of time occurs in which the processor or ASIC driving the RS-485 control lines (DE, \overline{RE}) is unable to ensure that the RS-485 Tx and Rx outputs are kept disabled. If the equipment is connected to the bus, a driver activating prematurely during power-up may crash the bus. To avoid this scenario, the ISL3179E and ISL3180E incorporate a

“hot plug” function. Circuitry monitoring V_{CC} ensures that, during power-up and power-down, the Tx and Rx outputs remain disabled, regardless of the state of DE and RE, if V_{CC} is less than $\sim 2.4V$. This gives the processor/ASIC a chance to stabilize and drive the RS-485 control lines to the proper states.



FIGURE 21. HOT PLUG PERFORMANCE (ISL3179E) vs ISL83485 WITHOUT HOT PLUG CIRCUITRY

Data Rate, Cables, and Terminations

RS-485/RS-422 are intended for network lengths up to 4000ft, but the maximum system data rate decreases as the transmission length increases. Devices operating at 40Mbps are limited to lengths less than 100ft.

Twisted pair is the cable of choice for RS-485/RS-422 networks. Twisted pair cables tend to pick up noise and other electromagnetically induced voltages as common-mode signals, which are effectively rejected by the differential receiver in this IC.

Proper termination is imperative to minimize reflections. In point-to-point, or point-to-multipoint (single driver on bus) networks, the main cable should be terminated in its characteristic impedance (typically 120Ω) at the end farthest from the driver. In multireceiver applications, stubs connecting receivers to the main cable should be kept as short as possible. Multipoint (multidriver) systems require that the main cable be terminated in its characteristic impedance at both ends. Stubs connecting a transceiver to the main cable should be kept as short as possible.

The ISL3179E and ISL3180E may also be used at slower data rates over longer cables, but some limitations apply. The Rx is optimized for high speed operation, so its output may glitch if the Rx input differential transition times are too slow. Keeping the transition times below 500ns, which equates to the Tx driving a 1000ft (305m) CAT 5 cable, yields excellent performance over the full operating temperature range.

Built-in Driver Overload Protection

As stated previously, the RS-485 specification requires that drivers survive worst case bus contentions undamaged. These transmitters meet this requirement using driver output short circuit current limits and on-chip thermal shutdown circuitry.

The driver output stages incorporate short-circuit current limiting circuitry, which ensures that the output current never exceeds the RS-485 specification, even at the common-mode voltage range extremes. In the event of a major short-circuit condition, the device also includes a thermal shutdown feature that disables the drivers whenever the die temperature becomes excessive. This eliminates the power dissipation, allowing the die to cool. The drivers automatically reenables after the die temperature drops about $+15^{\circ}C$. If the contention persists, the thermal shutdown/reenable cycle repeats until the fault is cleared. Receivers stay operational during thermal shutdown.

Low Power Shutdown Mode

The BiCMOS transceivers use a fraction of the power required by their bipolar counterparts, but they also include a shutdown feature that reduces the already low quiescent I_{CC} to a 50nA trickle. The devices enter shutdown whenever the receiver and driver are *simultaneously* disabled ($\overline{RE} = V_{CC}$ and $DE = GND$) for a period of at least 600ns. Disabling both the driver and the receiver for less than 60ns guarantees that the transceiver will not enter shutdown.

Note that receiver and driver enable times increase when the transceiver enables from shutdown. Refer to [Notes 12, 13, 14, 15 and 16](#) at the end of “[Electrical Specifications](#)” on [page 5](#) for more information.

Revision History

The revision history provided is for informational purposes only and is believed to be accurate, but not warranted. Please visit our website to make sure you have the latest revision.

| DATE | REVISION | CHANGE |
|--------------|----------|--|
| Nov 9, 2017 | FN6365.6 | Added the Related Literature section. Updated the Receiving Truth Table on page 3. Updated the header/footer. |
| Aug 25, 2015 | FN6365.5 | Added Key Differences table to page 1. |
| Jul 8, 2015 | FN6365.4 | Reformatted datasheet to newest template and standards. Features, page 1 - Changed: "- Class 3 HBM Level on all Other Pins.....>9kV" to: "- Class 3 HBM level on all other pins (ISL3179E).....>9kV" Pin Description on page 3 - Added row for EP pin and added to description of GND. Elec Spec table, page 6 ESD Performance section: Added "ISL3179E Only" to All Pins and changed Test Conditions for HBM and Machine Model to "per JEDEC". - Added 2 rows for "All Pins, ISL3180E Only" Updated note references on Figures 6B and 9B. Die Characteristics section on page 11: removed Transistor Count ESD Protection on page 12 - removed "and ISL3180E" from 1st sentence. Added Revision History table and About Intersil section. Updated POD L10.3x3C on page 16 from rev 2 to rev 4. Changes since rev 2: - Removed package outline and included center to center distance between lands on recommended land pattern. - Removed Note 4 "Dimension b applies to the metallized terminal and is measured between 0.18mm and 0.30mm from the terminal tip." since it is not applicable to this package. Renumbered notes accordingly. - Tiebar Note 4 updated From: Tiebar shown (if present) is a non-functional feature. To: Tiebar shown (if present) is a non-functional feature and may be located on any of the 4 sides (or ends). Updated POD M8.15 on page 17 from rev 3 to rev 4. Changes since rev 3: - Changed Note 1 "1982" to "1994" |

About Intersil

Intersil Corporation is a leading provider of innovative power management and precision analog solutions. The company's products address some of the largest markets within the industrial and infrastructure, mobile computing, and high-end consumer markets.

For the most updated datasheet, application notes, related documentation, and related parts, see the respective product information page found at www.intersil.com.

For a listing of definitions and abbreviations of common terms used in our documents, visit www.intersil.com/glossary.

You can report errors or suggestions for improving this datasheet by visiting www.intersil.com/ask.

Reliability reports are also available from our website at www.intersil.com/support.

© Copyright Intersil Americas LLC 2007-2017. All Rights Reserved.

All trademarks and registered trademarks are the property of their respective owners.

For additional products, see www.intersil.com/en/products.html

Intersil products are manufactured, assembled and tested utilizing ISO9001 quality systems as noted in the quality certifications found at www.intersil.com/en/support/qualandreliability.html

Intersil products are sold by description only. Intersil may modify the circuit design and/or specifications of products at any time without notice, provided that such modification does not, in Intersil's sole judgment, affect the form, fit or function of the product. Accordingly, the reader is cautioned to verify that datasheets are current before placing orders. Information furnished by Intersil is believed to be accurate and reliable. However, no responsibility is assumed by Intersil or its subsidiaries for its use; nor for any infringements of patents or other rights of third parties which may result from its use. No license is granted by implication or otherwise under any patent or patent rights of Intersil or its subsidiaries.

For information regarding Intersil Corporation and its products, see www.intersil.com

Package Outline Drawing

For the most recent package outline drawing, see [M8.118](#).

M8.118

8 LEAD MINI SMALL OUTLINE PLASTIC PACKAGE

Rev 4, 7/11

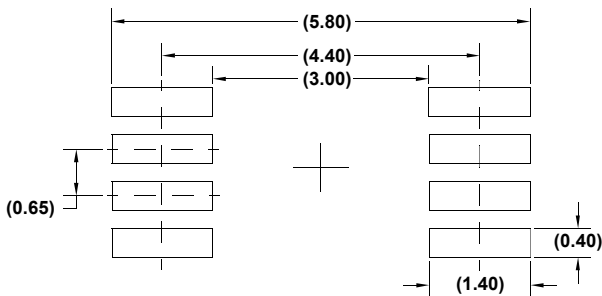
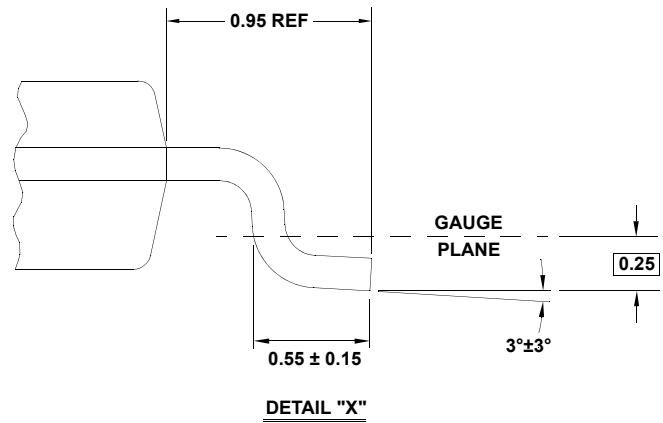
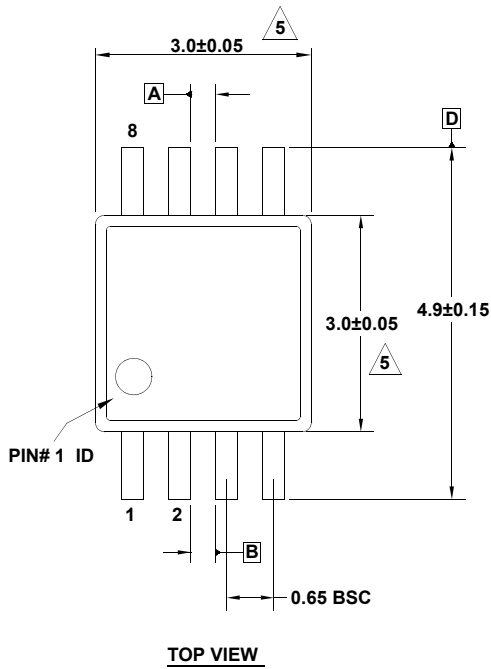

NOTES:

1. Dimensions are in millimeters.
2. Dimensioning and tolerancing conform to JEDEC MO-187-AA and AMSEY14.5m-1994.
3. Plastic or metal protrusions of 0.15mm max per side are not included.
4. Plastic interlead protrusions of 0.15mm max per side are not included.
5. Dimensions are measured at Datum Plane "H".
6. Dimensions in () are for reference only.

Package Outline Drawing

L10.3x3C

10 LEAD DUAL FLAT PACKAGE (DFN)

Rev 4, 3/15

For the most recent package outline drawing, see [L10.3x3C](#).

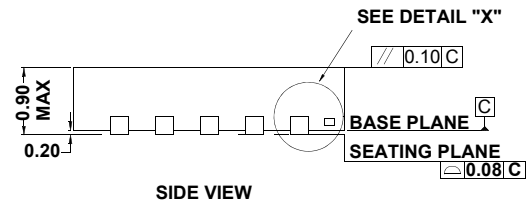
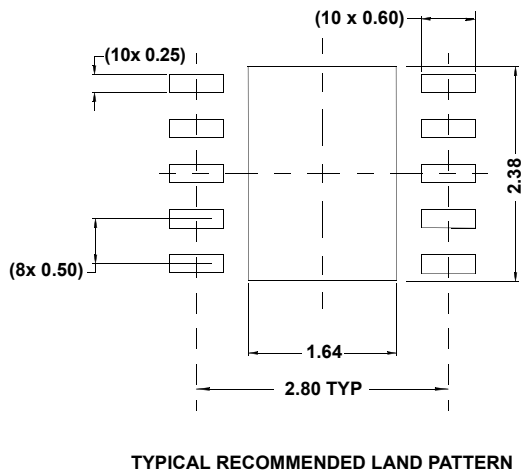

NOTES:

1. Dimensions are in millimeters.
Dimensions in () for Reference Only.
2. Dimensioning and tolerancing conform to AMSE Y14.5m-1994.
3. Unless otherwise specified, tolerance : Decimal ± 0.05
4. Tiebar shown (if present) is a non-functional feature and may be located on any of the 4 sides (or ends).
5. The configuration of the pin #1 identifier is optional, but must be located within the zone indicated. The pin #1 identifier may be either a mold or mark feature.
6. Compliant to JEDEC MO-229-WEED-3 except for E-PAD dimensions.

Package Outline Drawing

For the most recent package outline drawing, see [M8.15](#).

M8.15

8 LEAD NARROW BODY SMALL OUTLINE PLASTIC PACKAGE

Rev 4, 1/12



NOTES:

20. Dimensioning and tolerancing per ANSI Y14.5M-1994.
21. Package length does not include mold flash, protrusions or gate burrs. Mold flash, protrusion and gate burrs shall not exceed 0.15mm (0.006 inch) per side.
22. Package width does not include interlead flash or protrusions. Interlead flash and protrusions shall not exceed 0.25mm (0.010 inch) per side.
23. The chamfer on the body is optional. If it is not present, a visual index feature must be located within the crosshatched area.
24. Terminal numbers are shown for reference only.
25. The lead width as measured 0.36mm (0.014 inch) or greater above the seating plane, shall not exceed a maximum value of 0.61mm (0.024 inch).
26. Controlling dimension: MILLIMETER. Converted inch dimensions are not necessarily exact.
27. This outline conforms to JEDEC publication MS-012-AA ISSUE C.

Package Outline Drawing

For the most recent package outline drawing, see [M14.15](#).

M14.15

14 LEAD NARROW BODY SMALL OUTLINE PLASTIC PACKAGE

Rev 1, 10/09



NOTES:

1. Dimensions are in millimeters.
Dimensions in () for Reference Only.
2. Dimensioning and tolerancing conform to AMSEY14.5m-1994.
3. Datums A and B to be determined at Datum H.
4. Dimension does not include interlead flash or protrusions.
Interlead flash or protrusions shall not exceed 0.25mm per side.
5. The pin #1 identifier may be either a mold or mark feature.
6. Does not include dambar protrusion. Allowable dambar protrusion shall be 0.10mm total in excess of lead width at maximum condition.
7. Reference to JEDEC MS-012-AB.

X-ON Electronics

Largest Supplier of Electrical and Electronic Components

Click to view similar products for [RS-422/RS-485 Interface IC](#) category:

Click to view products by [Renesas](#) manufacturer:

Other Similar products are found below :

[NSI83085](#) [WS3088EESA-GEC](#) [ADM2687EBRIZ-RL7](#) [SN75LBC175ADR](#) [MAX489CPD+](#) [MAX491EPD+](#) [MAX488EEPA+](#)
[MAX3080CPD+](#) [MXL1535EEWI+](#) [SN65LBC173DR](#) [DS16F95J/883](#) [MAX490ESA+T](#) [LT1791CN#PBF](#) [LTM2881CY-3#PBF](#)
[LTC2857IMS8-2#PBF](#) [LT1791ACN#PBF](#) [MAX1487CUA+T](#) [XR3074XID-F](#) [XR3082XID-F](#) [SP1481EEN-L](#) [SN75ALS173NSR](#)
[ADM3491ARZ-REEL](#) [ADM485JN](#) [ADM1485ANZ](#) [ADM1485ARMZ](#) [ADM1485JNZ](#) [ADM1490EBRMZ](#) [ADM489ABRZ](#) [ADM3070EYRZ](#)
[ADM4850ACPZ-REEL7](#) [ADM4850ARMZ-REEL7](#) [ADM485ANZ](#) [ADM485ARMZ](#) [ADM485ARMZ-REEL7](#) [ADM485JNZ](#) [ADM488ANZ](#)
[ADM489ANZ](#) [ADM489ARUZ](#) [ADM3485ARZ-REEL7](#) [ADM3488EARZ-REEL7](#) [ADM3490ARZ](#) [ADM4856ARZ-REEL7](#) [ADM487EARZ-](#)
[REEL7](#) [ADM488ABRZ](#) [ADM1486ARZ](#) [ADM1490EBRZ-REEL7](#) [ADM3485ARZ](#) [ADM3490ARZ-REEL7](#) [ADM3490EARZ-REEL7](#)
[ADM4850ARZ](#)