

ISL68137-61P-EV1Z

Evaluation Board Quick Start User Guide

UG097
Rev 0.00
October 10, 2016

Description

The ISL68137-61P-EV1Z evaluation board provides users a method of evaluating the [ISL68137](#) digital multiphase device. Included on the board is a high-performance transient load generator capable of replicating the type of high di/dt loads typical of today's high current ASICs.

The ISL68137 is combined with the ISL99227 Smart Power Stage (SPS) to provide a highly efficient power solution capable of delivering up to 270A.

While the user may opt to evaluate the solution based on the Intersil default configuration, custom configurations are easily created using [PowerNavigator™](#).

Specifications

This board has been configured and optimized for the following operating conditions:

- 0.6V to 1.8V output range. Up to 3.05V with BOM change
- 6+1 phase: 270A + 30A
- Input range from 5V to 16V

Key Features

- 0.5% V_{OUT} regulation accuracy
- PMBus interface, AVSBus interface
- 3% I_{OUT} telemetry accuracy
- Onboard transient load to facilitate testing
- ATX or bench supply connections for input sources

Related Literature

- For a full list of related documents please visit our website - [ISL68137](#) product page

Ordering Information

PART NUMBER	DESCRIPTION
ISL68137-61P-EV1Z	ISL68137 evaluation board, 6+1 dual output (EVB, PMBus adapter, AVSBus adapter, two USB cables)

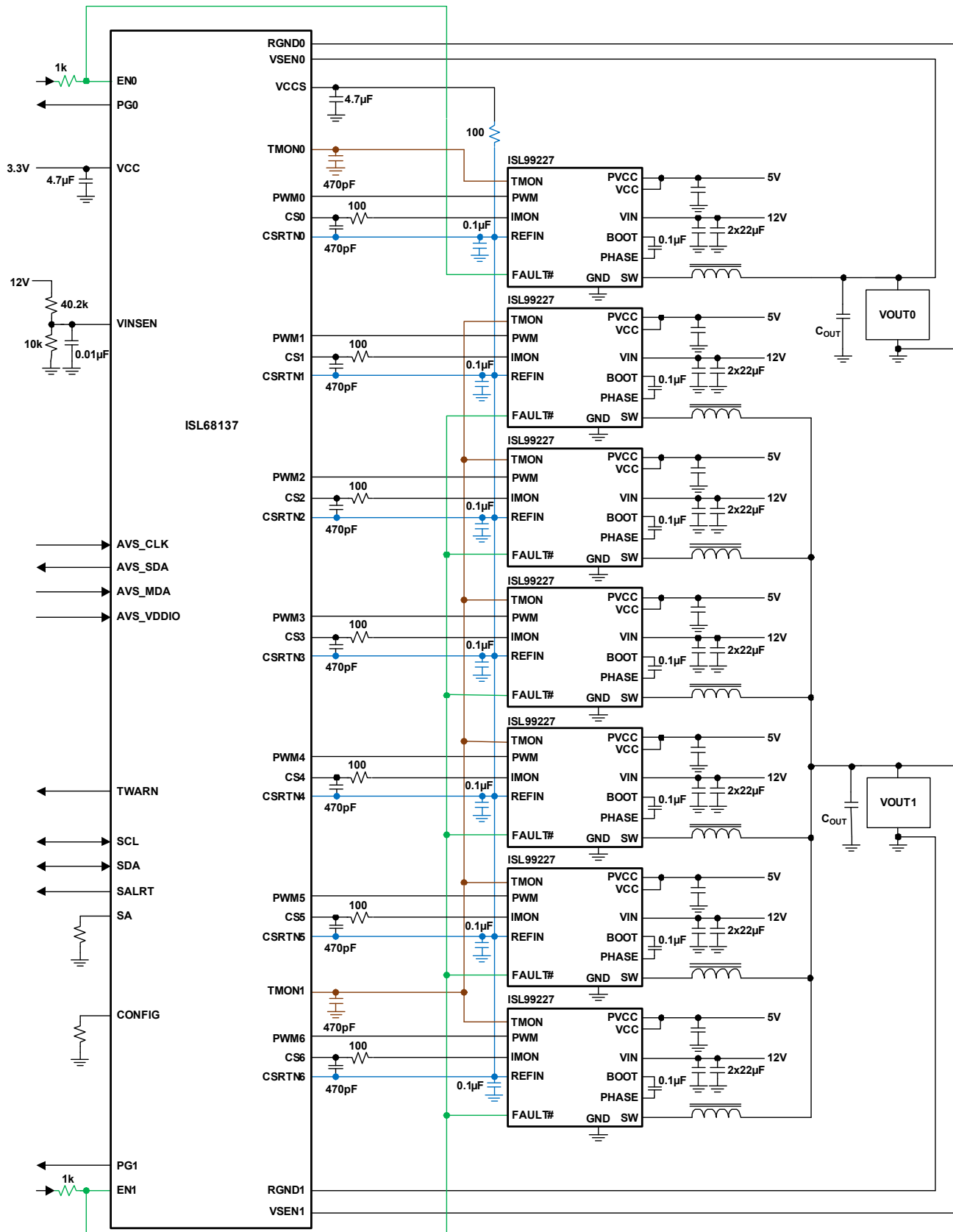

FIGURE 1. ISL68137-61P-EV1Z BLOCK DIAGRAM

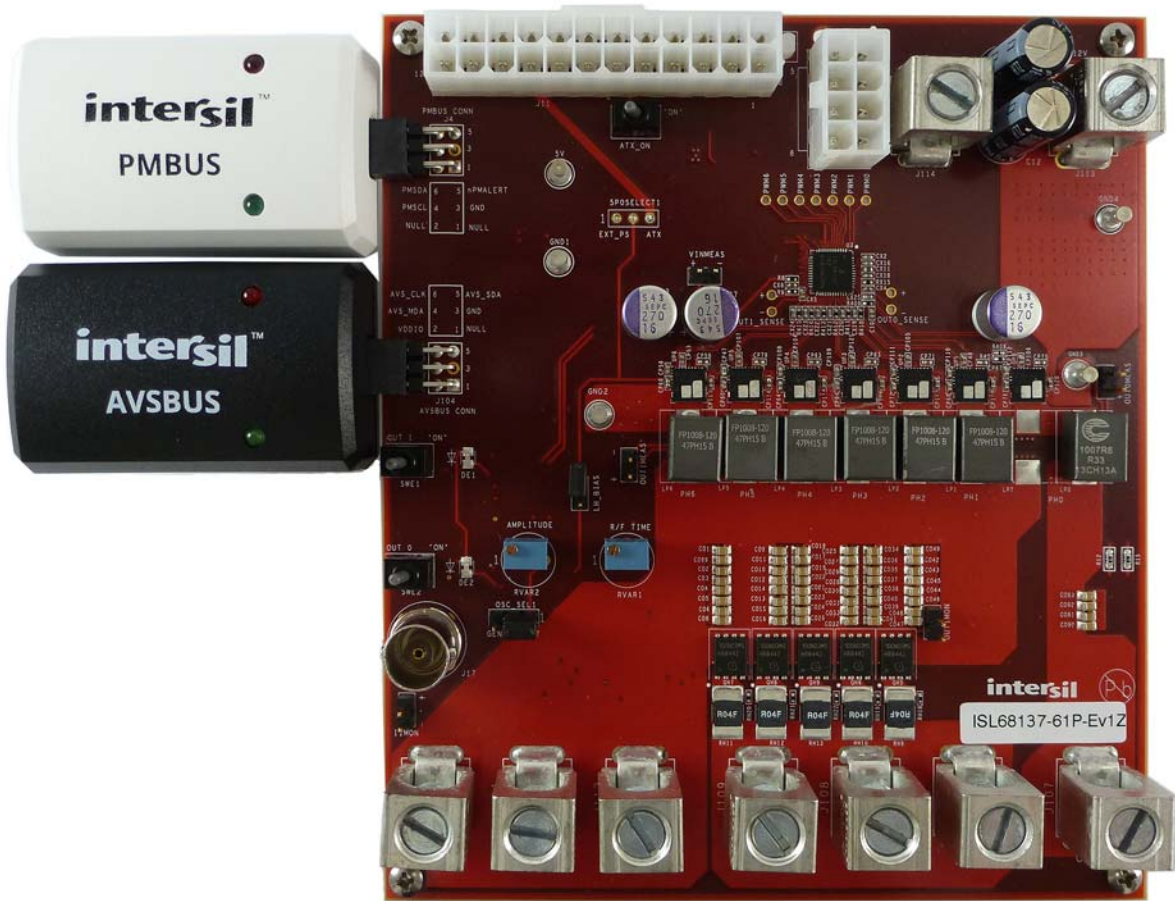

FIGURE 2. CONNECTIONS

Functional Description

The ISL68137-61P-EV1Z provides a convenient method to evaluate the performance of Intersil's family of digital multiphase devices and the onboard transient load provides a realistic way to exercise the regulators outstanding transient performance. IC details are described in the [ISL68137](#) datasheet.

The ISL68137-61P-EV1Z evaluation board is shown in [Figures 8](#) and [9](#). The hardware enables are controlled by toggle switches (SWE1 and SWE2). J4 is provided to interface directly with the Intersil USB to PMBus dongle provided with the evaluation board. J104 provides an interface to the Intersil USB to AVSBus dongle.

Input voltage is supplied via the ATX connectors or via bench supplies using the input connectors provided (J113, J114, 5V). High current output test lugs allow external loading.

Test points are provided to make efficiency data collection easy. VINMEAS, OUTOMEAS, and OUT1MEAS provide convenient points to acquire input and output voltage measurements ([Figure 3](#)).

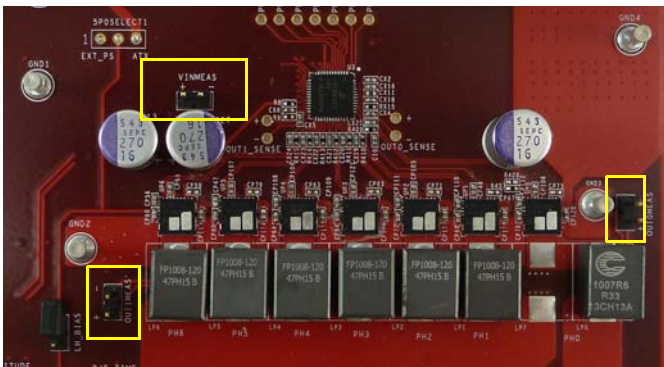

FIGURE 3. TEST POINTS

[Figures 11](#) through [15](#) show performance data typical of the digital multiphase devices.

Operating Range

This evaluation board is configured to support up to 270A on the six phase output and up to 30A on the single phase output. Input voltage range is from 5V to 16V.

Transient Load

The transient load on this board is attached to VOUT1 and is capable of $>100A$ and $>200A/\mu s$ for output voltage down to 1V. It is enabled by installing a jumper on the LH_BIAS header. Transient load current may be monitored from the I1MON header at 10mV/A. Note that while the generator is capable of very high currents, managing the total thermal load is critical. For this reason, it is advised that the duty cycle of the load is kept $<5\%$ or the temperature on the load generation components is monitored. Use of a fan will extend the capability of the load.

Transient load waveforms may be controlled using an internal oscillator or an external oscillator on J17. When using the internal oscillator, RVAR1 is used to adjust slew rate and RVAR2 is used to adjust amplitude of the transient load current.

OUT1MON provides a measurement point for Output 1 during transient load operation. Note that due to proximity to the power inductor, some oscilloscope probes may pick up a stray magnetic field. Care must be taken to ensure accurate measurement of the true output voltage ([Figure 4](#)).

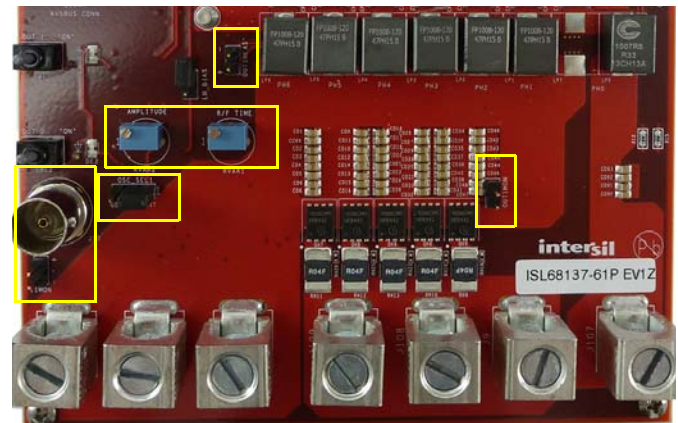

FIGURE 4. MEASUREMENT POINTS

Schematic and PCB Layout Guidelines

Intersil provides both a schematic checklist and PCB layout guide for the digital multiphase IC family. These are available at the [ISL68137](#) product page. In addition, full schematics, PCB files and BOM are provided for this evaluation board.

PowerNavigator™

PowerNavigator™ is required for proper evaluation of the digital multiphase devices. PowerNavigator™ and its User Guide are provided for download at [PowerNavigator™](#).

Default Configuration Settings

Intersil's default configurations for this board are provided via the Intersil website at the [ISL68137](#) product page and as part of the PowerNavigator™ GUI installation.

Power-Up Guide

1. Set SWE1-SWE2 to the OFF position.
2. Connect PMBus dongle to PC and J4.
3. If AVSBus functionality is desired, connect AVSBus dongle to PC and J104.
4. Connect input supply and load cables. If using bench supplies, connect both 5V and 12V.
5. Enable input supplies. If an ATX is used, this is accomplished with the ATX_ON switch.
6. Launch PowerNavigator™. Device should be discovered by PowerNavigator™. Select “Open Existing Project” (Figure 5).

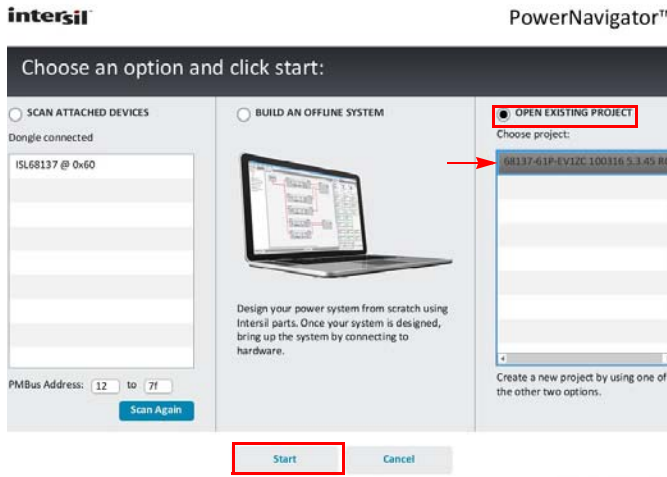

FIGURE 5. LAUNCH PowerNavigator™

7. Select ISL68137-61P-EV1Z and then click “START”.

8. Wait until PowerNavigator™ Power Map is populated and the telemetry meters are displayed (Figure 6).

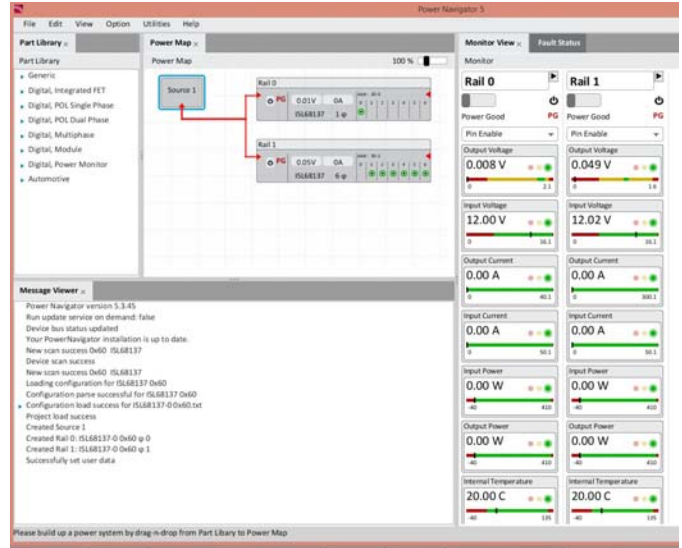

FIGURE 6. POWER NAVIGATOR DEFAULT VIEW

9. Use SWE1 and SWE2 to enable desired output (Figure 7).

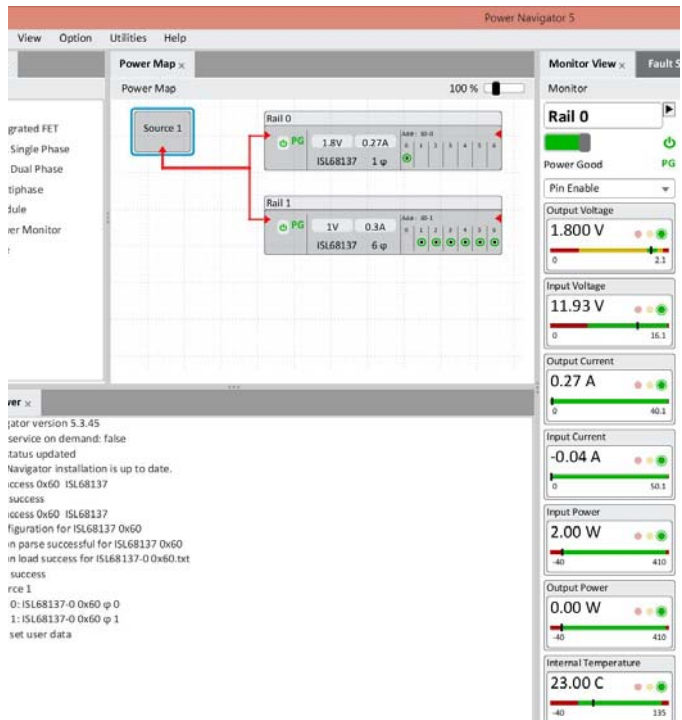

FIGURE 7. POWER MAP

10. Begin Testing.

ISL68137-61P-EV1Z Evaluation Board

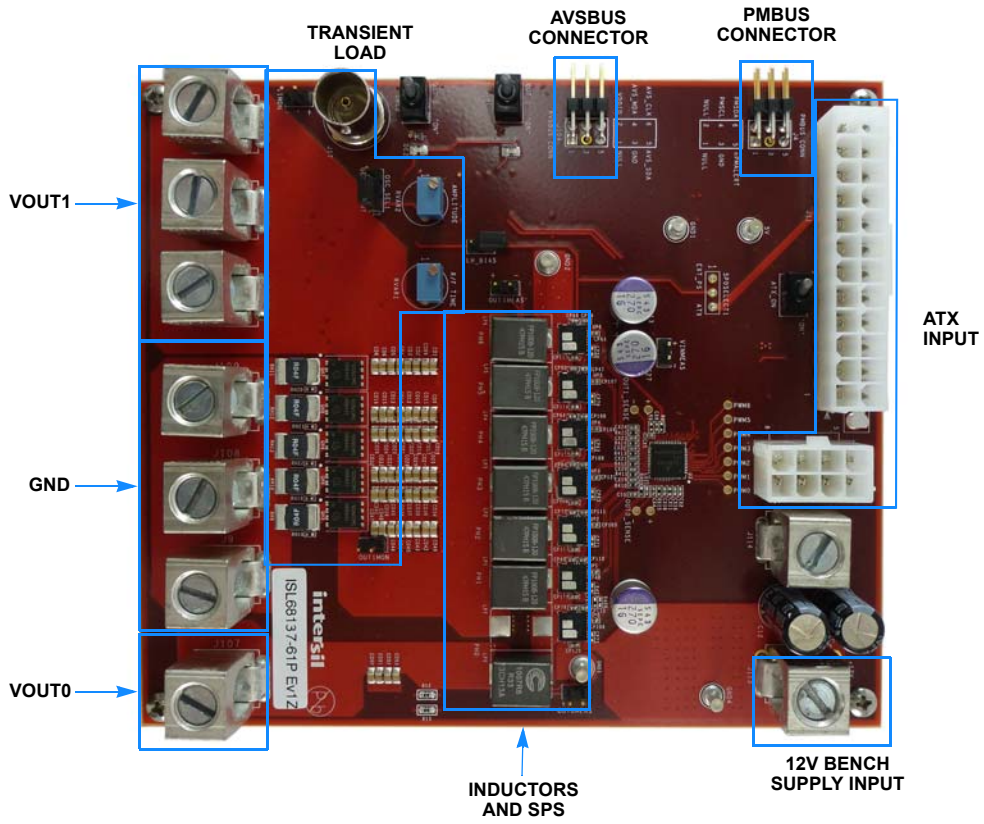

FIGURE 8. TOP SIDE

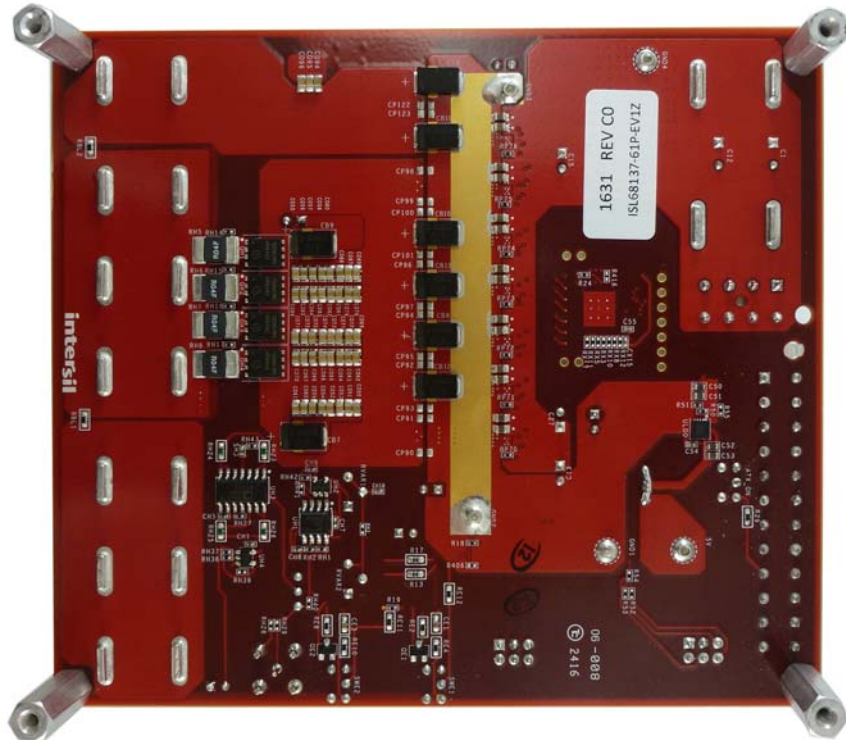

FIGURE 9. BOTTOM SIDE

Typical Performance Curves

Unless otherwise noted: $V_{IN} = 12V$, $f_{SW} = 400kHz$, APD disabled, $T_A = +25^\circ C$

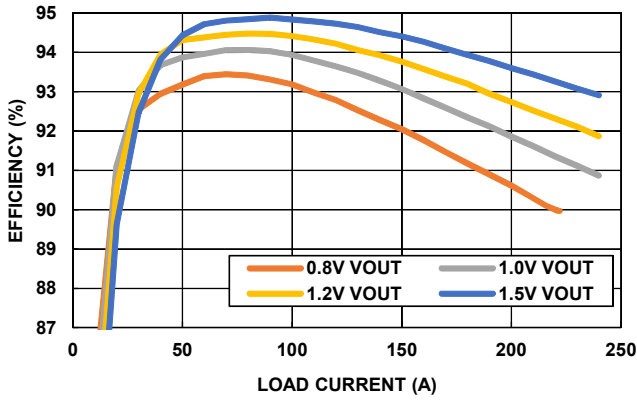

FIGURE 10. 6-PHASE EFFICIENCY

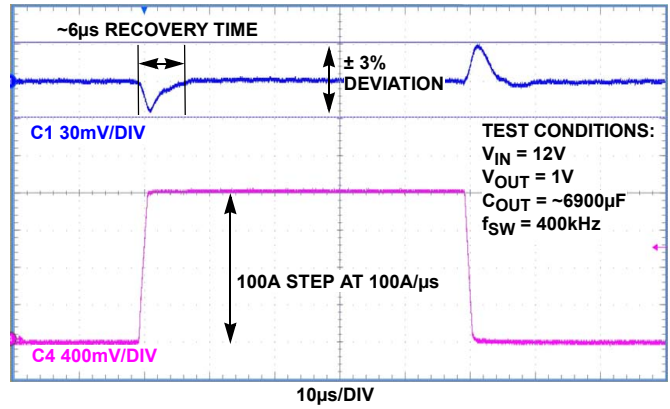

FIGURE 11. DYNAMIC LOAD STEP, 0A TO 100A, di/dt = 100A/μs

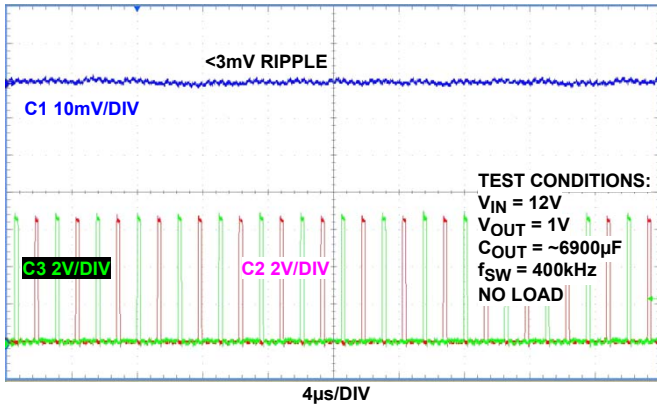

FIGURE 12. V_{OUT} RIPPLE, 3-PHASE INTERLEAVE

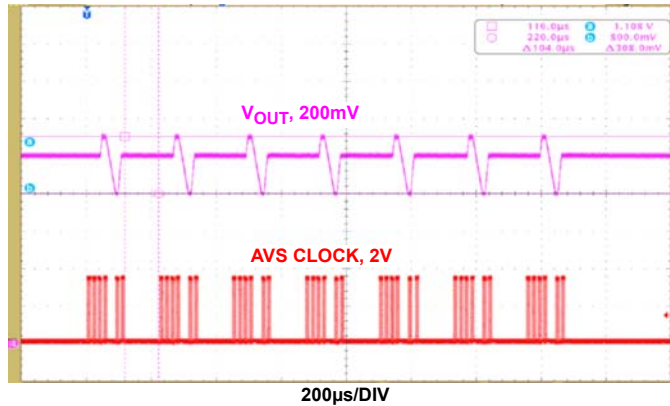

FIGURE 13. AVSBus DYNAMIC V_{OUT} TRANSITIONS

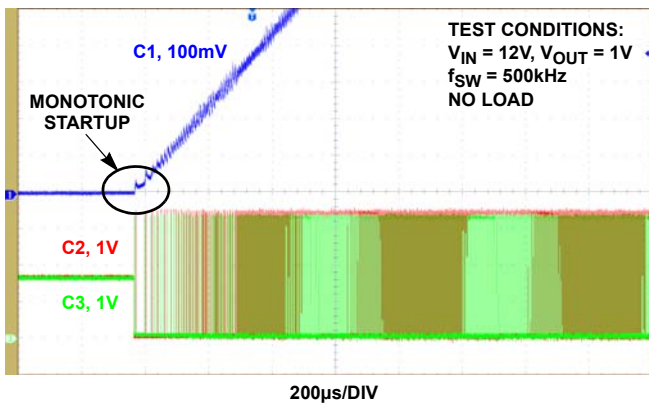

FIGURE 14. SOFT-START RAMP INITIATION

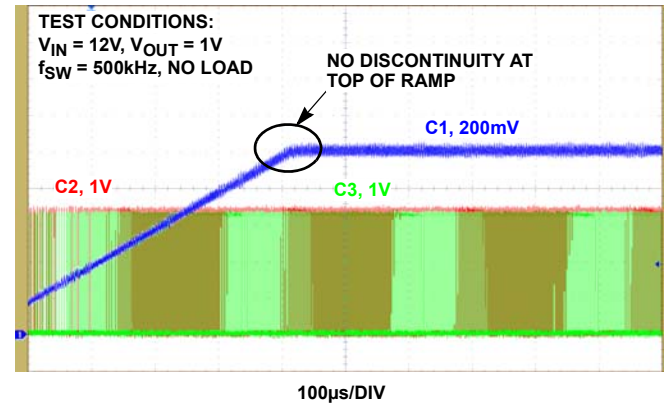

FIGURE 15. SOFT-START RAMP COMPLETION

Notice

1. Descriptions of circuits, software and other related information in this document are provided only to illustrate the operation of semiconductor products and application examples. You are fully responsible for the incorporation or any other use of the circuits, software, and information in the design of your product or system. Renesas Electronics disclaims any and all liability for any losses and damages incurred by you or third parties arising from the use of these circuits, software, or information.
 2. Renesas Electronics hereby expressly disclaims any warranties against and liability for infringement or any other claims involving patents, copyrights, or other intellectual property rights of third parties, by or arising from the use of Renesas Electronics products or technical information described in this document, including but not limited to, the product data, drawings, charts, programs, algorithms, and application examples.
 3. No license, express, implied or otherwise, is granted hereby under any patents, copyrights or other intellectual property rights of Renesas Electronics or others.
 4. You shall not alter, modify, copy, or reverse engineer any Renesas Electronics product, whether in whole or in part. Renesas Electronics disclaims any and all liability for any losses or damages incurred by you or third parties arising from such alteration, modification, copying or reverse engineering.
 5. Renesas Electronics products are classified according to the following two quality grades: "Standard" and "High Quality". The intended applications for each Renesas Electronics product depends on the product's quality grade, as indicated below.
"Standard": Computers; office equipment; communications equipment; test and measurement equipment; audio and visual equipment; home electronic appliances; machine tools; personal electronic equipment; industrial robots; etc.
"High Quality": Transportation equipment (automobiles, trains, ships, etc.); traffic control (traffic lights); large-scale communication equipment; key financial terminal systems; safety control equipment; etc.
Unless expressly designated as a high reliability product or a product for harsh environments in a Renesas Electronics data sheet or other Renesas Electronics document, Renesas Electronics products are not intended or authorized for use in products or systems that may pose a direct threat to human life or bodily injury (artificial life support devices or systems; surgical implantations; etc.), or may cause serious property damage (space system; undersea repeaters; nuclear power control systems; aircraft control systems; key plant systems; military equipment; etc.). Renesas Electronics disclaims any and all liability for any damages or losses incurred by you or any third parties arising from the use of any Renesas Electronics product that is inconsistent with any Renesas Electronics data sheet, user's manual or other Renesas Electronics document.
 6. When using Renesas Electronics products, refer to the latest product information (data sheets, user's manuals, application notes, "General Notes for Handling and Using Semiconductor Devices" in the reliability handbook, etc.), and ensure that usage conditions are within the ranges specified by Renesas Electronics with respect to maximum ratings, operating power supply voltage range, heat dissipation characteristics, installation, etc. Renesas Electronics disclaims any and all liability for any malfunctions, failure or accident arising out of the use of Renesas Electronics products outside of such specified ranges.
 7. Although Renesas Electronics endeavors to improve the quality and reliability of Renesas Electronics products, semiconductor products have specific characteristics, such as the occurrence of failure at a certain rate and malfunctions under certain use conditions. Unless designated as a high reliability product or a product for harsh environments in a Renesas Electronics data sheet or other Renesas Electronics document, Renesas Electronics products are not subject to radiation resistance design. You are responsible for implementing safety measures to guard against the possibility of bodily injury, injury or damage caused by fire, and/or danger to the public in the event of a failure or malfunction of Renesas Electronics products, such as safety design for hardware and software, including but not limited to redundancy, fire control and malfunction prevention, appropriate treatment for aging degradation or any other appropriate measures. Because the evaluation of microcomputer software alone is very difficult and impractical, you are responsible for evaluating the safety of the final products or systems manufactured by you.
 8. Please contact a Renesas Electronics sales office for details as to environmental matters such as the environmental compatibility of each Renesas Electronics product. You are responsible for carefully and sufficiently investigating applicable laws and regulations that regulate the inclusion or use of controlled substances, including without limitation, the EU RoHS Directive, and using Renesas Electronics products in compliance with all these applicable laws and regulations. Renesas Electronics disclaims any and all liability for damages or losses occurring as a result of your noncompliance with applicable laws and regulations.
 9. Renesas Electronics products and technologies shall not be used for or incorporated into any products or systems whose manufacture, use, or sale is prohibited under any applicable domestic or foreign laws or regulations. You shall comply with any applicable export control laws and regulations promulgated and administered by the governments of any countries asserting jurisdiction over the parties or transactions.
 10. It is the responsibility of the buyer or distributor of Renesas Electronics products, or any other party who distributes, disposes of, or otherwise sells or transfers the product to a third party, to notify such third party in advance of the contents and conditions set forth in this document.
 11. This document shall not be reprinted, reproduced or duplicated in any form, in whole or in part, without prior written consent of Renesas Electronics.
 12. Please contact a Renesas Electronics sales office if you have any questions regarding the information contained in this document or Renesas Electronics products.
- (Note 1) "Renesas Electronics" as used in this document means Renesas Electronics Corporation and also includes its directly or indirectly controlled subsidiaries.
(Note 2) "Renesas Electronics product(s)" means any product developed or manufactured by or for Renesas Electronics.

(Rev.4.0-1 November 2017)



SALES OFFICES

Renesas Electronics Corporation

<http://www.renesas.com>

Refer to "<http://www.renesas.com/>" for the latest and detailed information.

Renesas Electronics America Inc.
1001 Murphy Ranch Road, Milpitas, CA 95035, U.S.A.
Tel: +1-408-432-8888, Fax: +1-408-434-5351

Renesas Electronics Canada Limited
9251 Yonge Street, Suite 8309 Richmond Hill, Ontario Canada L4C 9T3
Tel: +1-905-237-2004

Renesas Electronics Europe Limited
Dukes Meadow, Millboard Road, Bourne End, Buckinghamshire, SL8 5FH, U.K
Tel: +44-1628-651-700, Fax: +44-1628-651-804

Renesas Electronics Europe GmbH
Arcadiastrasse 10, 40472 Düsseldorf, Germany
Tel: +49-211-6503-0, Fax: +49-211-6503-1327

Renesas Electronics (China) Co., Ltd.
Room 1709 Quantum Plaza, No.27 ZhichunLu, Haidian District, Beijing, 100191 P. R. China
Tel: +86-10-8235-1155, Fax: +86-10-8235-7679

Renesas Electronics (Shanghai) Co., Ltd.
Unit 301, Tower A, Central Towers, 555 Langao Road, Putuo District, Shanghai, 200333 P. R. China
Tel: +86-21-2226-0888, Fax: +86-21-2226-0999

Renesas Electronics Hong Kong Limited
Unit 1601-1611, 16/F., Tower 2, Grand Century Place, 193 Prince Edward Road West, Mongkok, Kowloon, Hong Kong
Tel: +852-2265-6688, Fax: +852-2886-9022

Renesas Electronics Taiwan Co., Ltd.
13F, No. 363, Fu Shing North Road, Taipei 10543, Taiwan
Tel: +886-2-8175-9600, Fax: +886-2-8175-9670

Renesas Electronics Singapore Pte. Ltd.
80 Bendemeer Road, Unit #06-02 Hyflux Innovation Centre, Singapore 339949
Tel: +65-6213-0200, Fax: +65-6213-0300

Renesas Electronics Malaysia Sdn.Bhd.
Unit 1207, Block B, Menara Amcorp, Amcorp Trade Centre, No. 18, Jln Persiaran Barat, 46050 Petaling Jaya, Selangor Darul Ehsan, Malaysia
Tel: +60-3-7955-9390, Fax: +60-3-7955-9510

Renesas Electronics India Pvt. Ltd.
No.777C, 100 Feet Road, HAL 2nd Stage, Indiranagar, Bangalore 560 038, India
Tel: +91-80-67208700, Fax: +91-80-67208777

Renesas Electronics Korea Co., Ltd.
17F, KAMCO Yangjae Tower, 262, Gangnam-daero, Gangnam-gu, Seoul, 06265 Korea
Tel: +82-2-558-3737, Fax: +82-2-558-5338

X-ON Electronics

Largest Supplier of Electrical and Electronic Components

Click to view similar products for [Power Management IC Development Tools](#) category:

Click to view products by [Renesas](#) manufacturer:

Other Similar products are found below :

[EVAL-ADM1168LQEBZ](#) [EVB-EP5348UI](#) [MIC23451-AAAYFL EV](#) [MIC5281YMME EV](#) [DA9063-EVAL](#) [ADP122-3.3-EVALZ](#) [ADP130-0.8-EVALZ](#) [ADP130-1.2-EVALZ](#) [ADP130-1.5-EVALZ](#) [ADP130-1.8-EVALZ](#) [ADP1714-3.3-EVALZ](#) [ADP1716-2.5-EVALZ](#) [ADP1740-1.5-EVALZ](#) [ADP1752-1.5-EVALZ](#) [ADP1828LC-EVALZ](#) [ADP1870-0.3-EVALZ](#) [ADP1871-0.6-EVALZ](#) [ADP1873-0.6-EVALZ](#) [ADP1874-0.3-EVALZ](#) [ADP1882-1.0-EVALZ](#) [ADP199CB-EVALZ](#) [ADP2102-1.25-EVALZ](#) [ADP2102-1.875EVALZ](#) [ADP2102-1.8-EVALZ](#) [ADP2102-2-EVALZ](#) [ADP2102-3-EVALZ](#) [ADP2102-4-EVALZ](#) [ADP2106-1.8-EVALZ](#) [ADP2147CB-110EVALZ](#) [AS3606-DB](#) [BQ24010EVM](#) [BQ24075TEVM](#) [BQ24155EVM](#) [BQ24157EVM-697](#) [BQ24160EVM-742](#) [BQ24296MEVM-655](#) [BQ25010EVM](#) [BQ3055EVM](#) [NCV891330PD50GEVB](#) [ISLUSBI2CKIT1Z](#) [LM2744EVAL](#) [LM2854EVAL](#) [LM3658SD-AEV/NOPB](#) [LM3658SDEV/NOPB](#) [LM3691TL-1.8EV/NOPB](#) [LM4510SDEV/NOPB](#) [LM5033SD-EVAL](#) [LP38512TS-1.8EV](#) [EVAL-ADM1186-1MBZ](#) [EVAL-ADM1186-2MBZ](#)