

## 5V, Ultra High Speed, PROFIBUS®, RS-485/RS-422 Transceivers

The Intersil ISL4486 and ISL81486 are BiCMOS, 5V powered, single transceivers that meet both the RS-485 and RS-422 standards for balanced communication, and feature the larger output voltage and higher data rate - up to 40Mbps - required by high speed PROFIBUS applications.

Unlike competitive products, these Intersil devices are specified for 10% tolerance supplies (4.5V to 5.5V) and deliver at least a 2.3V differential output voltage over this supply range. At the 5% tolerance specified by many competitors, the ISL4486 delivers an unsurpassed 2.5V differential signal into a 54Ω total load. This translates into longer reach, or better data integrity, at the exceptional 40Mbps data rate.

SCSI applications benefit from the ISL4486's low receiver and transmitter part-to-part skews, which make it perfect for high speed parallel applications where large numbers of bits must be simultaneously captured. The low bit-to-bit skew eases the timing constraints on the data latching signal.

These devices present a "0.6 unit load" to the RS-485 bus, which allows up to 50 transceivers on the network.

Receiver (Rx) inputs feature a "fail-safe if open" design, which ensures a logic high Rx output if Rx inputs are floating.

Driver (Tx) outputs are short circuit protected, even for voltages exceeding the power supply voltage. Additionally, on-chip thermal shutdown circuitry disables the Tx outputs to prevent damage if power dissipation becomes excessive.

### Ordering Information

PART NO. (BRAND)	TEMP. RANGE (°C)	PACKAGE	PKG. DWG. #
ISL4486IB (4486IB)	-40 to 85	8 Ld SOIC	M8.15
ISL4486IBZ (4486IB) (See Note)	-40 to 85	8 Ld SOIC (Pb-free)	M8.15
ISL4486IU (4486)	-40 to 85	8 Ld MSOP	M8.118
ISL4486IUZ (4486) (See Note)	-40 to 85	8 Ld MSOP (Pb-free)	M8.118
ISL81486IB (81486IB)	-40 to 85	8 Ld SOIC	M8.15
ISL81486IBZ (81486IB) (See Note)	-40 to 85	8 Ld SOIC (Pb-free)	M8.15
ISL81486IU (1486)	-40 to 85	8 Ld MSOP	M8.118
ISL81486IUZ (1486) (See Note)	-40 to 85	8 Ld MSOP (Pb-free)	M8.118

\*Add "-T" suffix to part number for tape and reel packaging.

NOTE: Intersil Pb-free products employ special Pb-free material sets; molding compounds/die attach materials and 100% matte tin plate termination finish, which is compatible with both SnPb and Pb-free soldering operations. Intersil Pb-free products are MSL classified at Pb-free peak reflow temperatures that meet or exceed the Pb-free requirements of IPC/JEDEC J Std-020B.

### Features

- Specified for 10% Tolerance Supplies
- High Data Rates  
ISL4486 . . . . . up to 40Mbps  
ISL81486 . . . . . up to 30Mbps
- Large Differential Output Voltage . . . . . 3V into 54Ω
- Low Bit-to-Bit (Part-to-Part) Skew for Parallel Applications
- 0.6 Unit Load Allows up to 50 Devices on the Bus
- ISL81486 is a Drop-In Replacement for the ADM1486
- Low Quiescent Current . . . . . 800μA
- -7V to +12V Common Mode Input Voltage Range
- Three-State Rx and Tx Outputs
- 14ns (Max) Propagation Delays, 2ns (Max) Skew
- Operates from a Single +5V Supply (10% Tolerance)
- Current Limiting and Thermal Shutdown for driver Overload Protection
- Pb-free available

### Applications

- SCSI "Fast 40" Drivers and Receivers
- PROFIBUS DP and FMS Networks
- Factory Automation
- Field Bus Networks
- Security Networks
- Building Environmental Control Systems
- Industrial/Process Control Networks

### Pinout

ISL4486, ISL81486 (SOIC, MSOP)  
TOP VIEW

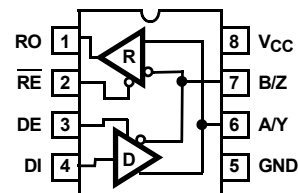

**Truth Table**

TRANSMITTING				
INPUTS			OUTPUTS	
$\overline{RE}$	DE	DI	B/Z	A/Y
X	1	1	0	1
X	1	0	1	0
X	0	X	High-Z	High-Z

**Truth Table**

RECEIVING			
INPUTS			OUTPUT
$\overline{RE}$	DE	A-B	RO
0	0	$\geq +0.2V$	1
0	0	$\leq -0.2V$	0
0	0	Inputs Open	1
1	X	X	High-Z

**Pin Descriptions**

PIN	FUNCTION
RO	Receiver output: If $A > B$ by at least 0.2V, RO is high; If $A < B$ by 0.2V or more, RO is low; RO = High if A and B are unconnected (floating).
$\overline{RE}$	Receiver output enable. RO is enabled when $\overline{RE}$ is low; RO is high impedance when $\overline{RE}$ is high.
DE	Driver output enable. The driver outputs, Y and Z, are enabled by bringing DE high. They are high impedance when DE is low.
DI	Driver input. A low on DI forces output Y low and output Z high. Similarly, a high on DI forces output Y high and output Z low.
GND	Ground connection.
A/Y	RS-485/422 level, noninverting receiver input and noninverting driver output. Pin is an input (A) if DE = 0; pin is an output (Y) if DE = 1.
B/Z	RS-485/422 level, inverting receiver input and inverting driver output. Pin is an input (B) if DE = 0; pin is an output (Z) if DE = 1.
V <sub>CC</sub>	System power supply input (4.5V to 5.5V).

**Typical Operating Circuit**

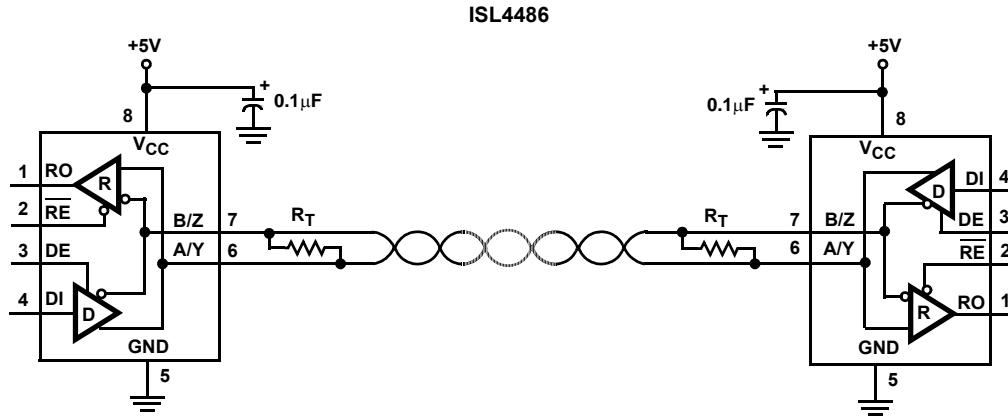

**Absolute Maximum Ratings**

V <sub>CC</sub> to Ground	7V
Input Voltages	
DI, DE, RE	-0.5V to 7V
Input/Output Voltages	
A/Y, B/Z	-8V to +12.5V
RO	-0.5V to (V <sub>CC</sub> +0.5V)
Short Circuit Duration	
Y, Z	Continuous

**Thermal Information**

Thermal Resistance (Typical, Note 1)	θ <sub>JA</sub> (°C/W)
8 Ld SOIC Package	105
8 Ld MSOP Package	140
Maximum Junction Temperature (Plastic Package)	150°C
Maximum Storage Temperature Range	-65°C to 150°C
Maximum Lead Temperature (Soldering 10s) (Lead Tips Only)	300°C

**Operating Conditions**

Temperature Range	
ISLXX861X	-40°C to 85°C

CAUTION: Stresses above those listed in "Absolute Maximum Ratings" may cause permanent damage to the device. This is a stress only rating and operation of the device at these or any other conditions above those indicated in the operational sections of this specification is not implied.

NOTE:

- θ<sub>JA</sub> is measured with the component mounted on a high effective thermal conductivity test board in free air. See Tech Brief TB379 for details.

Electrical Specifications      Test Conditions: V<sub>CC</sub> = 4.5V to 5.5V; Unless Otherwise Specified. Typicals are at V<sub>CC</sub> = 5V, T<sub>A</sub> = 25°C, Note 2

PARAMETER	SYMBOL	TEST CONDITIONS	TEMP (°C)	MIN	TYP	MAX	UNITS	
<b>DC CHARACTERISTICS</b>								
Driver Differential V <sub>OUT</sub> (no load)	V <sub>OD1</sub>		Full	-	-	V <sub>CC</sub>	V	
Driver Differential V <sub>OUT</sub> (with load)	V <sub>OD2</sub>	R = 50Ω (RS-422) (Figure 1A)	Full	2.5	3.7	-	V	
		R = 27Ω (RS-485), V <sub>CC</sub> ≥ 4.75V (Figure 1A, ISL4486 Only)	Full	2.5	3	5	V	
		R = 27Ω (RS-485), V <sub>CC</sub> = 4.5V (Figure 1A)	Full	2.3	-	5	V	
		R <sub>D</sub> = 60Ω, -7V ≤ V <sub>CM</sub> ≤ 12V, V <sub>CC</sub> ≥ 4.75V (Figure 1B)	Full	2.4	-	-	V	
Change in Magnitude of Driver Differential V <sub>OUT</sub> for Complementary Output States	ΔV <sub>OD</sub>	R = 27Ω or 50Ω, (Figure 1A)	Full	-	0.01	0.2	V	
Driver Common-Mode V <sub>OUT</sub>	V <sub>OC</sub>	R = 27Ω or 50Ω (Figure 1A)	Full	-	-	3	V	
Change in Magnitude of Driver Common-Mode V <sub>OUT</sub> for Complementary Output States	ΔV <sub>OC</sub>	R = 27Ω or 50Ω (Figure 1A)	Full	-	0.01	0.2	V	
Logic Input High Voltage	V <sub>IH</sub>	DE, DI, RE	Full	2	-	-	V	
Logic Input Low Voltage	V <sub>IL</sub>	DE, DI, RE	Full	-	-	0.8	V	
Logic Input Current	I <sub>IN1</sub>	DE, DI, RE	Full	-1	-	1	μA	
Input Current (A/Y, B/Z) (Note 5)	I <sub>IN2</sub>	DE = 0V, V <sub>CC</sub> = 0V or 4.5 to 5.5V	V <sub>IN</sub> = 12V	Full	-	-	0.6	mA
			V <sub>IN</sub> = -7V	Full	-0.35	-	-	mA
Receiver Differential Threshold Voltage	V <sub>TH</sub>	-7V ≤ V <sub>CM</sub> ≤ 12V	Full	-0.2	-	0.2	V	
Receiver Input Hysteresis	ΔV <sub>TH</sub>	V <sub>CM</sub> = 0V	25	-	40	-	mV	
Receiver Output High Voltage	V <sub>OH</sub>	I <sub>O</sub> = -4mA, V <sub>ID</sub> = 200mV	Full	4	-	-	V	
Receiver Output Low Voltage	V <sub>OL</sub>	I <sub>O</sub> = -4mA, V <sub>ID</sub> = 200mV	Full	-	-	0.4	V	
Three-State (high impedance) Receiver Output Current	I <sub>OZR</sub>	0.4V ≤ V <sub>O</sub> ≤ 2.4V	Full	-	-	±1	μA	
Receiver Input Resistance	R <sub>IN</sub>	-7V ≤ V <sub>CM</sub> ≤ 12V (Note 7)	Full	20	-	-	kΩ	
No-Load Supply Current (Note 3)	I <sub>CC</sub>	DI, RE = 0V or V <sub>CC</sub>	DE = V <sub>CC</sub>	Full	-	1	2	mA
			DE = 0V	Full	-	0.8	1.5	mA

## ISL4486, ISL81486

### Electrical Specifications

Test Conditions:  $V_{CC} = 4.5V$  to  $5.5V$ ; Unless Otherwise Specified. Typical values are at  $V_{CC} = 5V$ ,  $T_A = 25^\circ C$ ,  
 Note 2 (Continued)

PARAMETER	SYMBOL	TEST CONDITIONS	TEMP (°C)	MIN	TYP	MAX	UNITS	
Driver Short-Circuit Current, $V_O = \text{High or Low}$	$I_{OSD1}$	$DE = V_{CC}$ , $-7V \leq V_Y$ or $V_Z \leq 12V$ (Note 4)	Full	60	-	250	mA	
Receiver Short-Circuit Current	$I_{OSR}$	$0V \leq V_O \leq V_{CC}$	Full	7	-	85	mA	
<b>SWITCHING CHARACTERISTICS</b>								
Driver Input to Output Prop Delay	$t_{PLH}$ , $t_{PHL}$	$R_{DIFF} = 54\Omega$ , $C_L = 100pF$ (Figure 2)	ISL4486	Full	3	9	14	ns
			ISL81486	Full	3	9	17	ns
Prop Delay Delta, Min-to-Max	$t_{DP-PSKEW}$	$R_{DIFF} = 54\Omega$ , $C_L = 100pF$ , ISL4486 Only (Note 6, Figure 2)	Full	-	0	6	ns	
Driver Prop Delay Skew	$t_{SKEW}$	$R_{DIFF} = 54\Omega$ , $C_L = 100pF$ (Figure 2)	Full	-	0	2	ns	
Driver Differential Rise or Fall Time	$t_R$ , $t_F$	$R_{DIFF} = 54\Omega$ , $C_L = 100pF$ (Figure 2)	ISL4486	Full	-	5	8	ns
			ISL81486	Full	-	7	15	ns
Driver Enable to Output High	$t_{ZH}$	$C_L = 50pF$ , $SW = GND$ (Figure 3)	Full	-	9	15	ns	
Driver Enable to Output Low	$t_{ZL}$	$C_L = 50pF$ , $SW = V_{CC}$ (Figure 3)	Full	-	9	15	ns	
Matched Enable Switching $ t_{AZH} - t_{BZL} $ or $ t_{BZH} - t_{AZL} $	$\Delta t_{EN}$	At Identical Test Conditions (Figure 3)	Full	-	1	3	ns	
Driver Disable from Output High	$t_{HZ}$	$C_L = 50pF$ , $SW = GND$ (Figure 3)	Full	-	9	15	ns	
Driver Disable from Output Low	$t_{LZ}$	$C_L = 50pF$ , $SW = V_{CC}$ (Figure 3)	Full	-	9	15	ns	
Matched Disable Switching $ t_{AHZ} - t_{BLZ} $ or $ t_{BHZ} - t_{ALZ} $	$\Delta t_{DIS}$	At Identical Test Conditions (Figure 3)	Full	-	2	5	ns	
Driver Maximum Data Rate	$f_{MAXD}$	$ V_{OD}  \geq 1.5V$ (Figure 4)	ISL4486	Full	40	-	-	Mbps
			ISL81486	Full	30	-	-	Mbps
Receiver Input to Output Prop Delay	$t_{PLH}$ , $t_{PHL}$	(Figure 5)	ISL4486	Full	11	17	25	ns
			ISL81486	Full	6	17	25	ns
Prop Delay Delta, Min-to-Max	$t_{RP-PSKEW}$	ISL4486 Only (Note 6, Figure 5)	Full	-	0	9	ns	
Receiver Prop Delay Skew $ t_{PLH} - t_{PHL} $	$t_{SKD}$	Figure 5	Full	-	0.5	3	ns	
Receiver Enable to Output High	$t_{ZH}$	$C_L = 15pF$ , $SW = GND$ (Figure 6)	Full	-	7	13	ns	
Receiver Enable to Output Low	$t_{ZL}$	$C_L = 15pF$ , $SW = V_{CC}$ (Figure 6)	Full	-	7	13	ns	
Receiver Disable from Output High	$t_{HZ}$	$C_L = 15pF$ , $SW = GND$ (Figure 6)	Full	-	7	13	ns	
Receiver Disable from Output Low	$t_{LZ}$	$C_L = 15pF$ , $SW = V_{CC}$ (Figure 6)	Full	-	7	13	ns	
Receiver Maximum Data Rate	$f_{MAXR}$	$C_L = 15pF$ , $V_{ID} \geq 1.5V$ , $RO$ $t_H$ and $t_L \geq 20ns$	Full	40	-	-	Mbps	

#### NOTES:

- All currents into device pins are positive; all currents out of device pins are negative. All voltages are referenced to device ground unless otherwise specified.
- Supply current specification is valid for loaded drivers when  $DE = 0V$ .
- Applies to peak current. See "Typical Performance Curves" for more information.
- Devices meeting these limits are denoted as "0.6 unit load (UL)" transceivers. The RS-485 standard allows up to 32 Unit Loads on the bus, so a 0.6UL transceiver permits > 50 devices on the bus.
- This is the part-to-part skew between any two units tested with identical test conditions (Temperature,  $V_{CC}$ , etc.).

Test Circuits and Waveforms

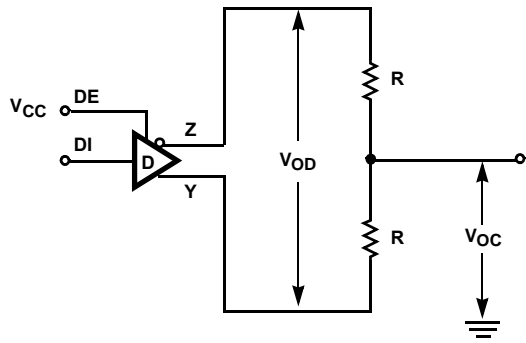

FIGURE 1A.  $V_{OD}$  AND  $V_{OC}$

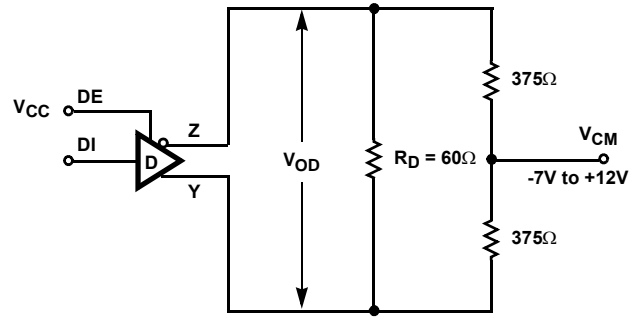

FIGURE 1B.  $V_{OD}$  WITH COMMON MODE LOAD

FIGURE 1. DC DRIVER TEST CIRCUITS

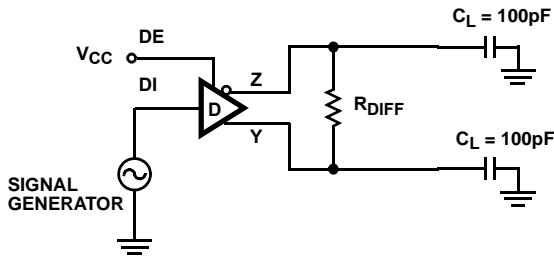

FIGURE 2A. TEST CIRCUIT

FIGURE 2. DRIVER PROPAGATION DELAY AND DIFFERENTIAL TRANSITION TIMES

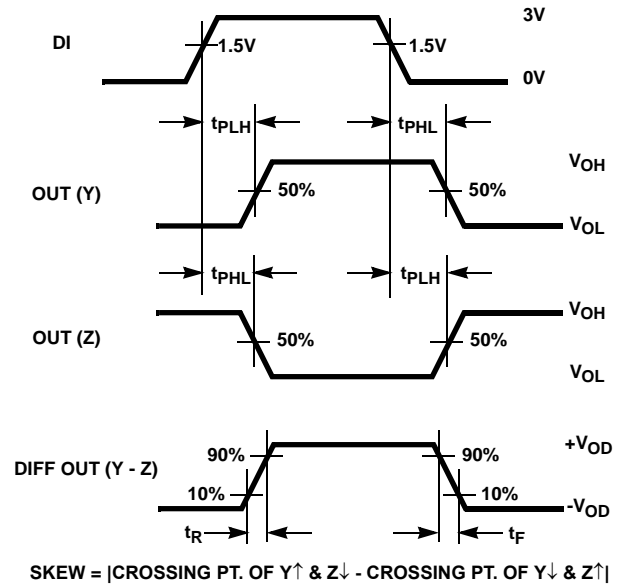

FIGURE 2B. MEASUREMENT POINTS

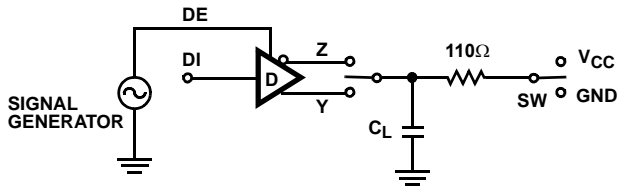

FIGURE 3A. TEST CIRCUIT

FIGURE 3. DRIVER ENABLE AND DISABLE TIMES

PARAMETER	OUTPUT	$\overline{RE}$	DI	SW	$C_L$ (pF)
$t_{HZ}$	Y/Z	X	1/0	GND	50
$t_{LZ}$	Y/Z	X	0/1	$V_{CC}$	50
$t_{ZH}$	Y/Z	X	1/0	GND	50
$t_{ZL}$	Y/Z	X	0/1	$V_{CC}$	50

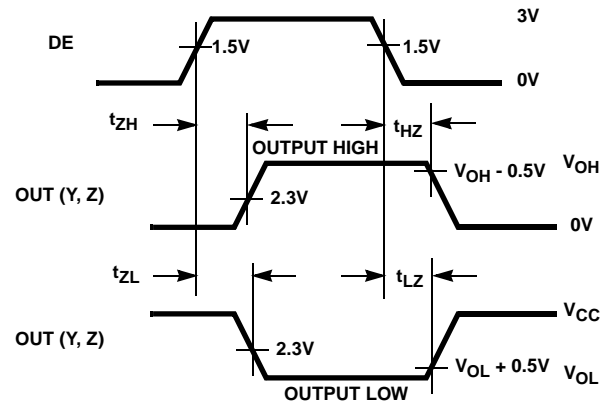

FIGURE 3B. MEASUREMENT POINTS

Test Circuits and Waveforms (Continued)

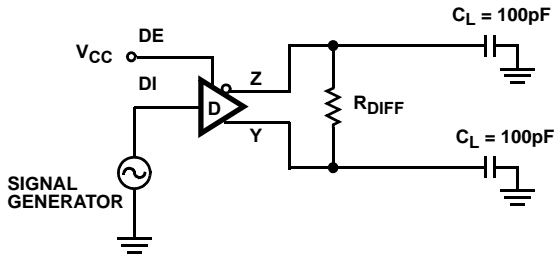

FIGURE 4A. TEST CIRCUIT

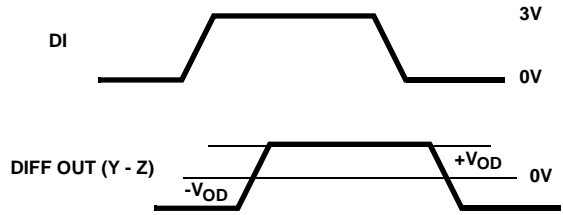

FIGURE 4B. MEASUREMENT POINTS

FIGURE 4. DRIVER DATA RATE

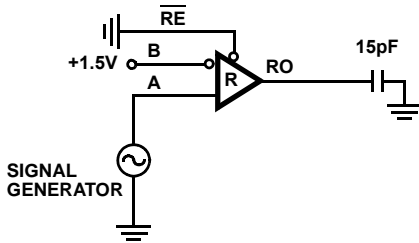

FIGURE 5A. TEST CIRCUIT

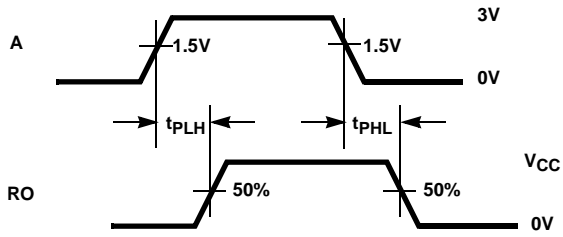

FIGURE 5B. MEASUREMENT POINTS

FIGURE 5. RECEIVER PROPAGATION DELAY

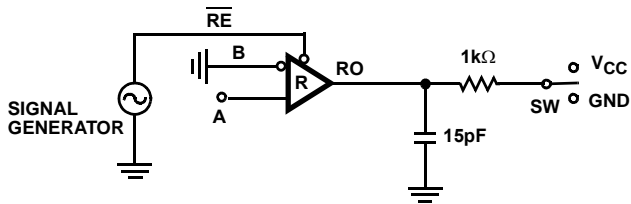

FIGURE 6A. TEST CIRCUIT

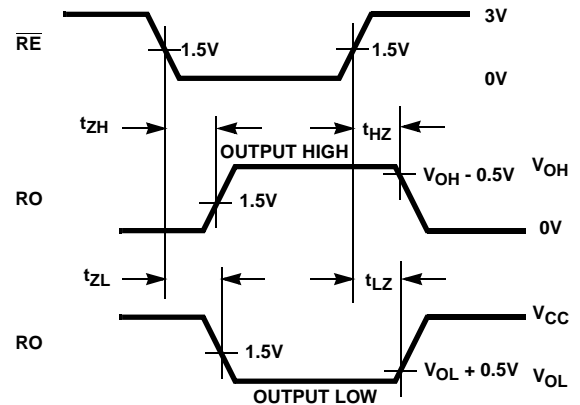

FIGURE 6B. MEASUREMENT POINTS

FIGURE 6. RECEIVER ENABLE AND DISABLE TIMES

PARAMETER	DE	A	SW
$t_{HZ}$	0	+1.5V	GND
$t_{LZ}$	0	-1.5V	$V_{CC}$
$t_{ZH}$	0	+1.5V	GND
$t_{ZL}$	0	-1.5V	$V_{CC}$

## Application Information

RS-485 and RS-422 are differential (balanced) data transmission standards for use in long haul or noisy environments. RS-422 is a subset of RS-485, so RS-485 transceivers are also RS-422 compliant. RS-422 is a point-to-multipoint (multidrop) standard, which allows only one driver and up to 10 (assuming one unit load devices) receivers on each bus. RS-485 is a true multipoint standard, which allows up to 32 one unit load devices (any mix of drivers and receivers) on each bus. To allow for multipoint operation, the RS-485 spec requires that drivers must handle bus contention without sustaining any damage.

Another important advantage of RS-485 is the extended common mode range (CMR), which specifies that the driver outputs and receiver inputs withstand signals that range from +12V to -7V. RS-422 and RS-485 are intended for runs as long as 4000' (~1200m), so the wide CMR is necessary to handle ground potential differences, as well as voltages induced in the cable by external fields.

### Receiver Features

These devices utilize a differential input receiver for maximum noise immunity and common mode rejection. Input sensitivity is  $\pm 200\text{mV}$ , as required by the RS422 and RS-485 specifications. Receiver inputs function with common mode voltages as great as 7V outside the power supplies (i.e., +12V and -7V), making them ideal for long networks, or industrial environments, where induced voltages are a realistic concern.

Receiver input resistance surpasses the RS-422 spec of  $4\text{k}\Omega$ , and exceeds the RS-485 "Unit Load" requirement of  $12\text{k}\Omega$  minimum. The  $20\text{k}\Omega$  input resistance allows at least 50 devices on the RS-485 bus. All the receivers include a "fail-safe if open" function that guarantees a high level receiver output if the receiver inputs are unconnected (floating).

Receivers easily meet the data rate supported by the driver, and receiver outputs are three-statable via the active low RE input.

### Driver Features

The RS-485/RS-422 driver is a differential output device that delivers at least 2.3V across a  $54\Omega$  load (RS-485/PROFIBUS), and at least 2.5V across a  $100\Omega$  load (RS-422) even with  $V_{CC} = 4.5\text{V}$ . The drivers feature low propagation delay skew to maximize bit width, and to minimize EMI.

Outputs of the drivers are not slew rate limited, so faster output transition times allow data rates of at least 40Mbps with the ISL4486, and 30Mbps with the ISL81486. Driver outputs are three-statable via the active high DE input.

For parallel applications, bit-to-bit skews between any two ISL4486 transmitter and receiver pairs are guaranteed to be no worse than 15ns (6ns max for any two Tx, 9ns max for any two Rx).

## Data Rate, Cables, and Terminations

Twisted pair is the cable of choice for RS-485, RS-422, and PROFIBUS networks. Twisted pair cables tend to pick up noise and other electromagnetically induced voltages as common mode signals, which are effectively rejected by the differential receivers in these ICs.

RS-485/RS-422 are intended for network lengths up to 4000' (~1200m), but the maximum system data rate decreases as the transmission length increases. According to guidelines in the RS-422 and PROFIBUS specifications, networks operating at data rates in excess of 3Mbps should be limited to cable lengths of 100m (328 feet) or less, and the PROFIBUS specification recommends that the more expensive "Type A" (22AWG) cable be used. Nevertheless, the ISL4486's large differential output swing, fast transition times, and high drive-current output stages allow operation at 40Mbps over standard "CAT5" cables in excess of 400 feet (121m). Figure 8 details the ISL4486 performance at this condition, with a  $120\Omega$  termination resistor at both the driver and the receiver ends. Note that the differential signal delivered to the receiver at the end of the cable (A-B) still exceeds 1V, so even longer cables could be driven if lower noise margins are acceptable. If more noise margin is desired, shorter cables produce a larger receiver input signal as illustrated in Figure 7. Performance should be even better if the "Type A" cable is utilized. The lower data rate of the ISL81486 allows for driving longer cables.

To minimize reflections, proper termination is imperative when using these high data rate transceivers. In point-to-point, or point-to-multipoint (single driver on bus) networks, the main cable should be terminated in its characteristic impedance (typically  $120\Omega$  for "CAT5", and  $220\Omega$  for "Type A") at the end farthest from the driver. In multi-receiver applications, stubs connecting receivers to the main cable should be kept as short as possible. Multipoint (multi-driver) systems require that the main cable be terminated in its characteristic impedance at both ends. Stubs connecting a transceiver to the main cable should be kept as short as possible.

### Built-In Driver Overload Protection

As stated previously, the RS-485 spec requires that drivers survive worst case bus contentions undamaged. These transmitters meet this requirement via driver output short circuit current limits, and on-chip thermal shutdown circuitry.

The driver output stages incorporate short circuit current limiting circuitry which ensures that the output current never exceeds the RS-485 spec, even at the common mode voltage range extremes. In the event of a major short circuit condition, the devices also include a thermal shutdown feature that disables the drivers whenever the die temperature becomes excessive. This eliminates the power dissipation, allowing the die to cool. The drivers automatically reenables after the die temperature drops about 15 degrees. If the contention persists, the thermal shutdown/reenable cycle repeats until the fault is cleared. Receivers stay operational during thermal shutdown.

**Typical Performance Curves**  $V_{CC} = 5V$ ,  $T_A = 25^\circ C$ , ISL4486 and ISL81486; Unless Otherwise Specified

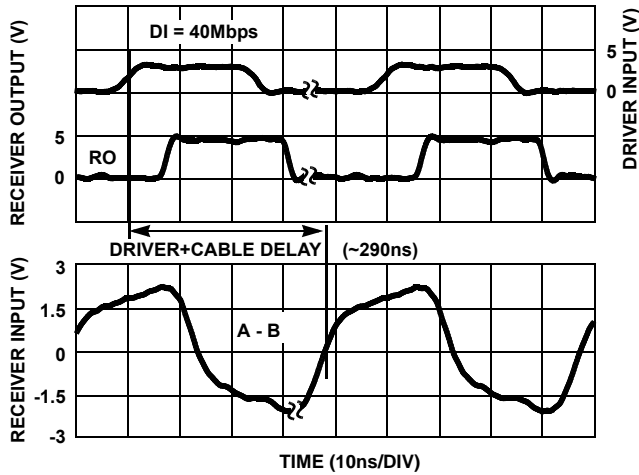

FIGURE 7. ISL4486 DRIVER AND RECEIVER WAVEFORMS DRIVING 200 FEET (61 METERS) OF CAT5 CABLE (DOUBLE TERMINATED WITH  $120\Omega$ )

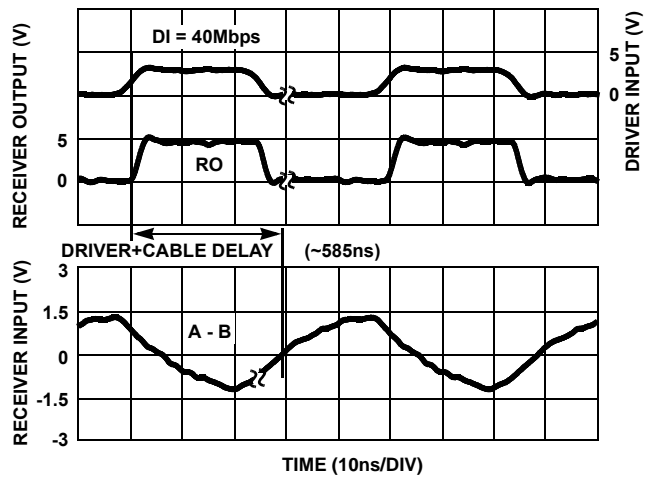

FIGURE 8. ISL4486 DRIVER AND RECEIVER WAVEFORMS DRIVING 400 FEET (121 METERS) OF CAT5 CABLE (DOUBLE TERMINATED WITH  $120\Omega$ )

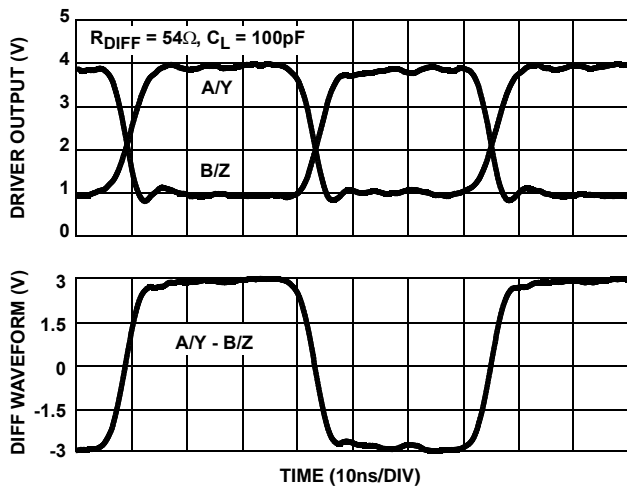

FIGURE 9. ISL81486 DRIVER WAVEFORMS AT 30Mbps PER FIGURE 4

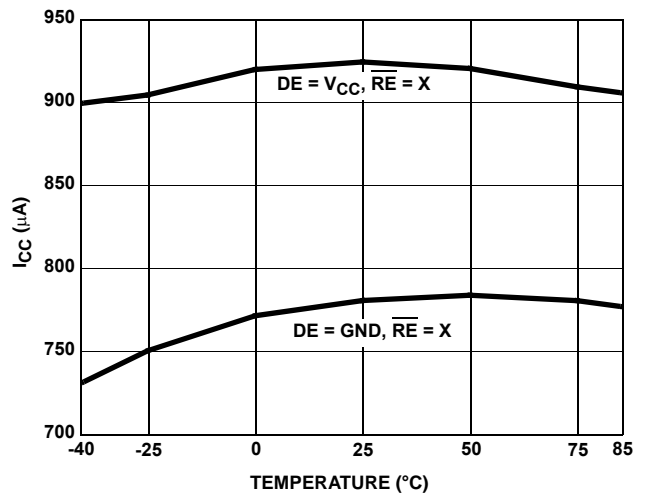

FIGURE 10. SUPPLY CURRENT vs TEMPERATURE

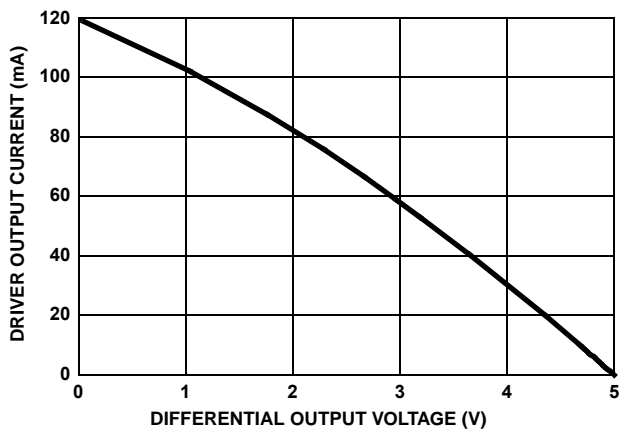

FIGURE 11. DRIVER OUTPUT CURRENT vs DIFFERENTIAL OUTPUT VOLTAGE

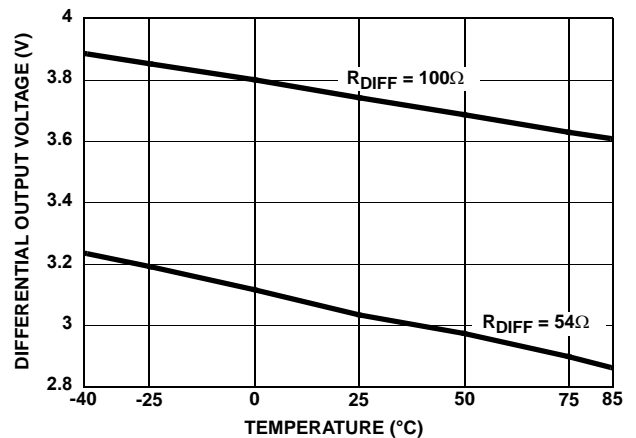

FIGURE 12. DRIVER DIFFERENTIAL OUTPUT VOLTAGE vs TEMPERATURE



**Typical Performance Curves**  $V_{CC} = 5V, T_A = 25^\circ C, ISL4486 \text{ and } ISL81486; \text{ Unless Otherwise Specified (Continued)}$

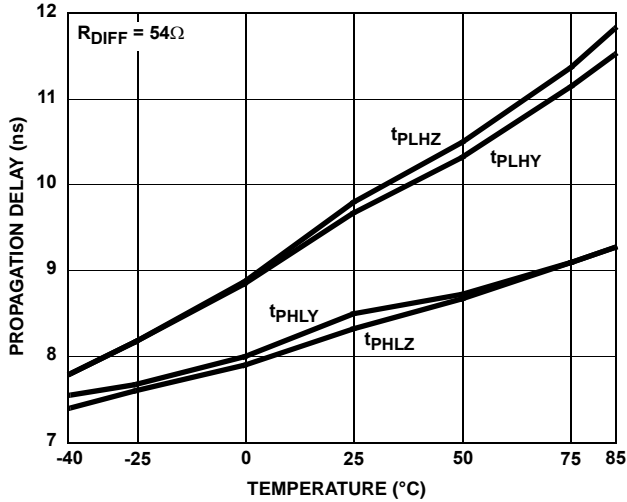

FIGURE 13. DRIVER PROPAGATION DELAY vs TEMPERATURE

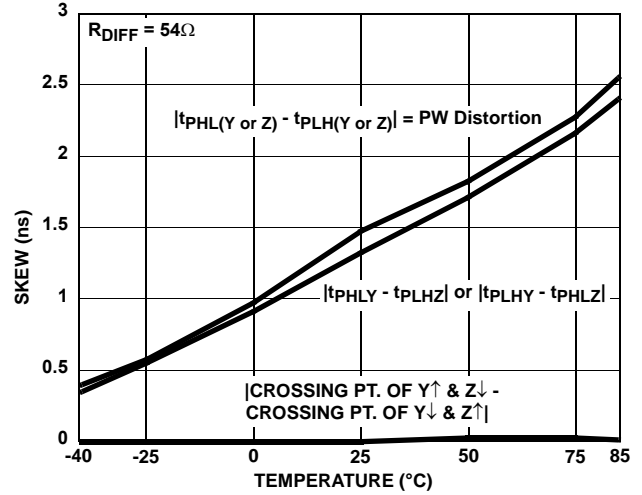

FIGURE 14. DRIVER SKEW AND PULSE DISTORTION vs TEMPERATURE

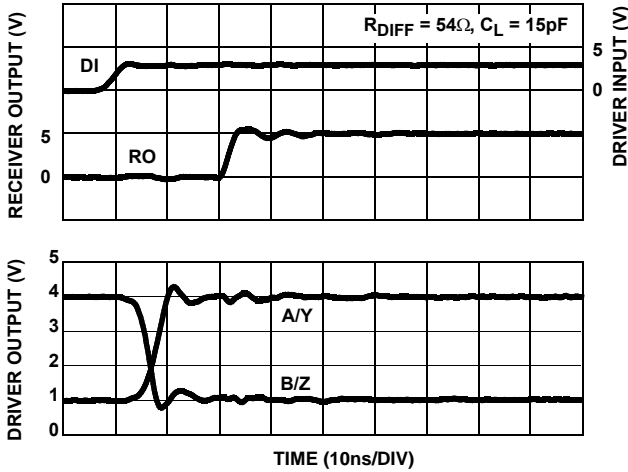

FIGURE 15. DRIVER AND RECEIVER WAVEFORMS, LOW TO HIGH

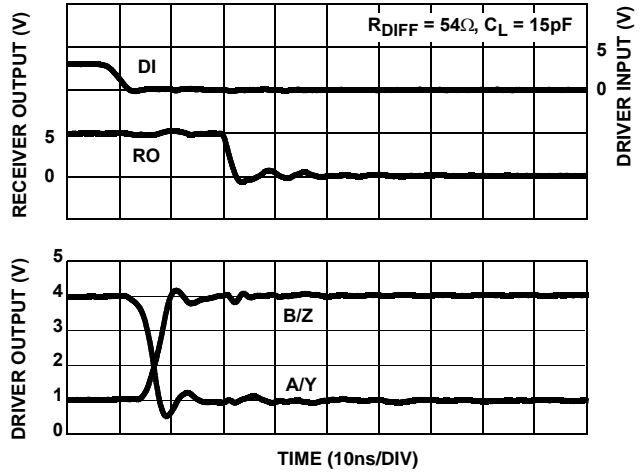

FIGURE 16. DRIVER AND RECEIVER WAVEFORMS, HIGH TO LOW

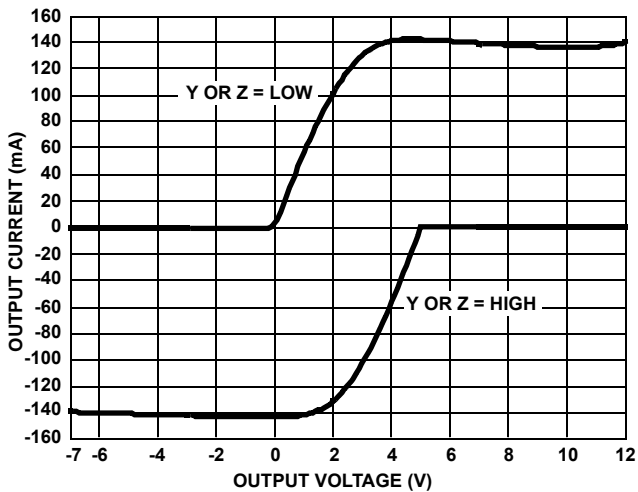

FIGURE 17. DRIVER OUTPUT CURRENT vs SHORT CIRCUIT VOLTAGE

**Die Characteristics**

SUBSTRATE POTENTIAL (POWERED UP):

GND

TRANSISTOR COUNT:

528

PROCESS:

Si Gate BiCMOS

Mini Small Outline Plastic Packages (MSOP)

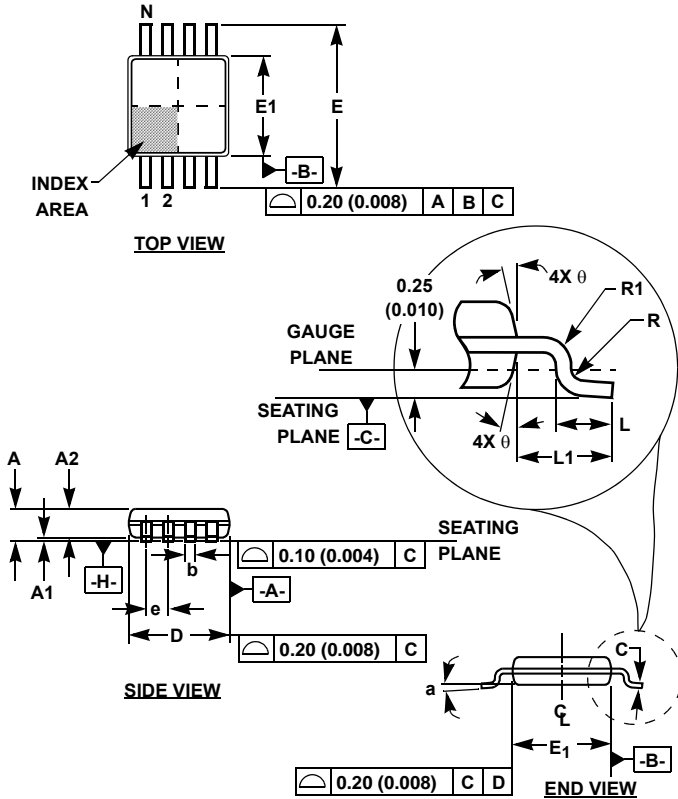

M8.118 (JEDEC MO-187AA)  
8 LEAD MINI SMALL OUTLINE PLASTIC PACKAGE

SYMBOL	INCHES		MILLIMETERS		NOTES
	MIN	MAX	MIN	MAX	
A	0.037	0.043	0.94	1.10	-
A1	0.002	0.006	0.05	0.15	-
A2	0.030	0.037	0.75	0.95	-
b	0.010	0.014	0.25	0.36	9
c	0.004	0.008	0.09	0.20	-
D	0.116	0.120	2.95	3.05	3
E1	0.116	0.120	2.95	3.05	4
e	0.026 BSC		0.65 BSC		-
E	0.187	0.199	4.75	5.05	-
L	0.016	0.028	0.40	0.70	6
L1	0.037 REF		0.95 REF		-
N	8		8		7
R	0.003	-	0.07	-	-
R1	0.003	-	0.07	-	-
θ	5°	15°	5°	15°	-
α	0°	6°	0°	6°	-

Rev. 2 01/03

NOTES:

1. These package dimensions are within allowable dimensions of JEDEC MO-187BA.
2. Dimensioning and tolerancing per ANSI Y14.5M-1994.
3. Dimension "D" does not include mold flash, protrusions or gate burrs and are measured at Datum Plane. Mold flash, protrusion and gate burrs shall not exceed 0.15mm (0.006 inch) per side.
4. Dimension "E1" does not include interlead flash or protrusions and are measured at Datum Plane. [-H-] Interlead flash and protrusions shall not exceed 0.15mm (0.006 inch) per side.
5. Formed leads shall be planar with respect to one another within 0.10mm (0.004) at seating Plane.
6. "L" is the length of terminal for soldering to a substrate.
7. "N" is the number of terminal positions.
8. Terminal numbers are shown for reference only.
9. Dimension "b" does not include dambar protrusion. Allowable dambar protrusion shall be 0.08mm (0.003 inch) total in excess of "b" dimension at maximum material condition. Minimum space between protrusion and adjacent lead is 0.07mm (0.0027 inch).
10. Datums [-A-] and [-B-] to be determined at Datum plane [-H-].
11. Controlling dimension: MILLIMETER. Converted inch dimensions are for reference only.

Small Outline Plastic Packages (SOIC)

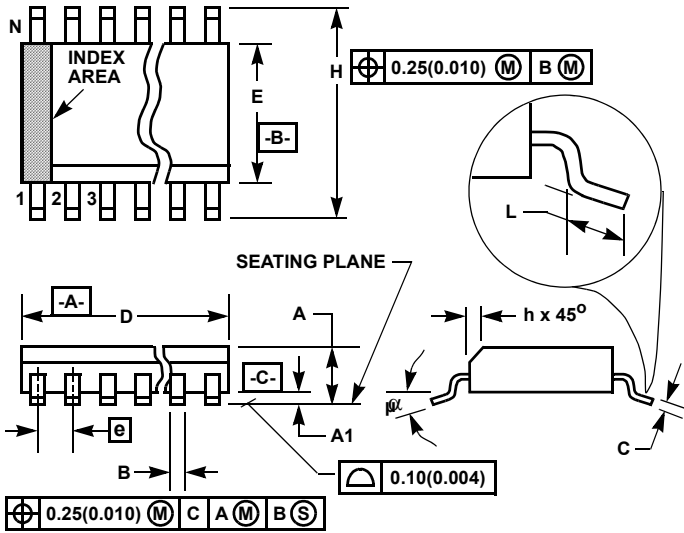

**M8.15 (JEDEC MS-012-AA ISSUE C)**  
**8 LEAD NARROW BODY SMALL OUTLINE PLASTIC PACKAGE**

SYMBOL	INCHES		MILLIMETERS		NOTES
	MIN	MAX	MIN	MAX	
A	0.0532	0.0688	1.35	1.75	-
A1	0.0040	0.0098	0.10	0.25	-
B	0.013	0.020	0.33	0.51	9
C	0.0075	0.0098	0.19	0.25	-
D	0.1890	0.1968	4.80	5.00	3
E	0.1497	0.1574	3.80	4.00	4
e	0.050 BSC		1.27 BSC		-
H	0.2284	0.2440	5.80	6.20	-
h	0.0099	0.0196	0.25	0.50	5
L	0.016	0.050	0.40	1.27	6
N	8		8		7
$\alpha$	0°	8°	0°	8°	-

NOTES:

1. Symbols are defined in the "MO Series Symbol List" in Section 2.2 of Publication Number 95.
2. Dimensioning and tolerancing per ANSI Y14.5M-1982.
3. Dimension "D" does not include mold flash, protrusions or gate burrs. Mold flash, protrusion and gate burrs shall not exceed 0.15mm (0.006 inch) per side.
4. Dimension "E" does not include interlead flash or protrusions. Interlead flash and protrusions shall not exceed 0.25mm (0.010 inch) per side.
5. The chamfer on the body is optional. If it is not present, a visual index feature must be located within the crosshatched area.
6. "L" is the length of terminal for soldering to a substrate.
7. "N" is the number of terminal positions.
8. Terminal numbers are shown for reference only.
9. The lead width "B", as measured 0.36mm (0.014 inch) or greater above the seating plane, shall not exceed a maximum value of 0.61mm (0.024 inch).
10. Controlling dimension: MILLIMETER. Converted inch dimensions are not necessarily exact.

Rev. 0 12/93

All Intersil U.S. products are manufactured, assembled and tested utilizing ISO9000 quality systems. Intersil Corporation's quality certifications can be viewed at [www.intersil.com/design/quality](http://www.intersil.com/design/quality)

*Intersil products are sold by description only. Intersil Corporation reserves the right to make changes in circuit design, software and/or specifications at any time without notice. Accordingly, the reader is cautioned to verify that data sheets are current before placing orders. Information furnished by Intersil is believed to be accurate and reliable. However, no responsibility is assumed by Intersil or its subsidiaries for its use; nor for any infringements of patents or other rights of third parties which may result from its use. No license is granted by implication or otherwise under any patent or patent rights of Intersil or its subsidiaries.*

For information regarding Intersil Corporation and its products, see [www.intersil.com](http://www.intersil.com)

## X-ON Electronics

Largest Supplier of Electrical and Electronic Components

*Click to view similar products for [RS-422/RS-485 Interface IC](#) category:*

*Click to view products by [Renesas](#) manufacturer:*

Other Similar products are found below :

[WS3088EESA-GEC](#) [ADM2687EBRIZ-RL7](#) [MAX489CPD+](#) [MAX491EPD+](#) [MAX488EEPA+](#) [MAX3080CPD+](#) [MXL1535EEWI+](#)  
[SN65LBC173DR](#) [MAX490ESA+T](#) [LTM2881IY-3#PBF](#) [LT1791CN#PBF](#) [LTM2881CY-3#PBF](#) [LTC2857IMS8-2#PBF](#) [LT1791ACN#PBF](#)  
[MAX1487CUA+T](#) [XR3074XID-F](#) [XR3082XID-F](#) [SP1481EEN-L](#) [SN75ALS173NSR](#) [ADM3491ARZ-REEL](#) [ADM485JN](#) [ADM1485ANZ](#)  
[ADM1485ARMZ](#) [ADM1485JNZ](#) [ADM2682EBRIZ](#) [ADM3076EARZ-REEL7](#) [ADM489ABRZ](#) [ADM3070EYRZ](#) [ADM4850ACPZ-REEL7](#)  
[ADM4850ARMZ-REEL7](#) [ADM485ANZ](#) [ADM485ARMZ](#) [ADM485JNZ](#) [ADM488ANZ](#) [ADM489ANZ](#) [ADM489ARUZ](#) [ADM3485ARZ-](#)  
[REEL7](#) [ADM3486EARZ-REEL7](#) [ADM3488EARZ-REEL7](#) [ADM3490ARZ](#) [ADM3493ARZ](#) [ADM4856ARZ-REEL7](#) [ADM487EARZ-REEL7](#)  
[ADM488ABRZ](#) [ADM1486ARZ](#) [ADM1490EBRZ-REEL7](#) [ADM3485ARZ](#) [ADM3490ARZ-REEL7](#) [ADM3490EARZ-REEL7](#)  
[ADM4850ARZ](#)