

ISL8202MEVAL1Z

Evaluation Board

UG071
Rev.0.00
May 3, 2016

The [ISL8202M](#) power module is a single-channel synchronous step-down complete power supply, capable of delivering up to 3A of continuous current. Operating from a single 2.6V to 5.5V input power rail and integrating a controller, power inductor and MOSFETs, the ISL8202M can achieve up to 95% conversion efficiency. It also provides fast transient response with excellent loop stability, and can deliver output voltage as low as 0.6V. Switching frequency is also adjustable from 680kHz to 3.5MHz with either external resistors or the SYNC clock option. The selectable PFM mode can also be enabled to boost up light-load efficiency to extend battery life. Other features include programmable soft-start, soft-stop, input undervoltage lockout, 100% duty cycle operation, over-temperature, overcurrent/short-circuit with hiccup mode, and overvoltage and negative overcurrent protection. The ISL8202M also has a dedicated enable pin and power-good flag that allows for easy system power rails sequencing.

The ISL8202MEVAL1Z evaluation board is designed to demonstrate the performance of the ISL8202M. By default, the board is set with a 1.2V output voltage with 1.5MHz switching frequency. Other output voltage values can be easily set by changing the jumper position. Switching frequency can be adjusted by changing the FS pin resistor.

References

- [ISL8202M](#) datasheet

Key Features

- 2.6V to 5.5V input voltage range
- Adjustable output voltage as low as 0.6V with $\pm 1.6\%$ accuracy over line/load/temperature
- Default 1.8MHz current mode control operations
 - 680kHz to 3.5MHz resistor adjustable
 - External synchronization up to 3.5MHz
 - Selectable light-load efficiency mode
 - 100% duty cycle LDO mode
- Programmable soft-start and soft-stop output discharge
- Dedicated enable pin and power-good flag
- UVLO, over-temperature, overcurrent, overvoltage and negative overcurrent protections

Specifications/Default Set-Up

- V_{IN} = 2.6V to 5.5V
- V_{OUT} options (via jumper selection): 1V, 1.2V, 2.5V, 3.3V
- MAX I_{OUT} up to 3A
- f_{SW} = 1.5MHz by default
- Set to PWM mode by default
- 1ms soft-start time by default

Ordering Information

PART NUMBER	DESCRIPTION
ISL8202MEVAL1Z	ISL8202M single 3A power module evaluation board

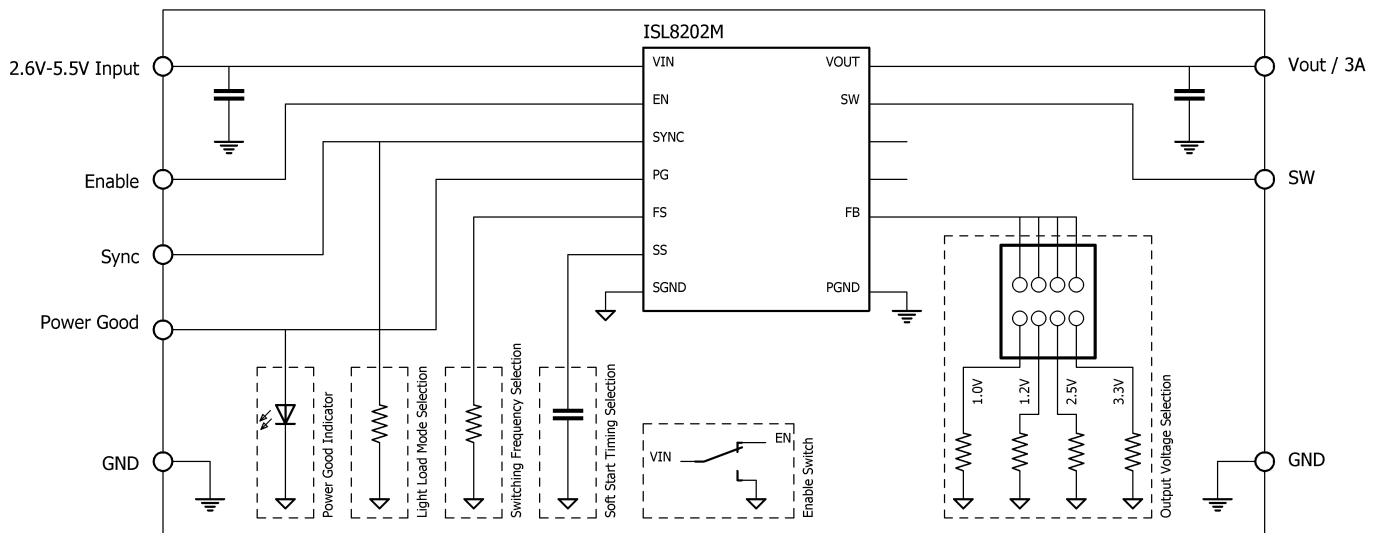

FIGURE 1. ISL8202MEVAL1Z BLOCK DIAGRAM

TABLE 1. ISL8202M COMPONENT SELECTION GUIDE MATRIX

V _{IN} (V)	V _{OUT} (V)	f _{SW} (MHz)	C _{IN} (μF)	C _{OUT} (μF)	R ₇ (kΩ)	R _{SET} (kΩ)	C _{FF} (pF)
5	0.6	0.8	2x22	3x22	261	OPEN	680
5	0.9	1.2	2x22	3x22	169	200	680
5	1	1.3	2x22	2x22	154	150	820
5	1.2	1.5	2x22	2x22	130	100	680
5	1.5	1.9	2x22	2x22	102	66.5	390
5	1.8	2	2x22	2x22	95.3	49.9	390
5	2.5	2	2x22	2x22	95.3	31.6	220
5	3.3	2	2x22	2x22	95.3	22.1	390
3.3	0.6	0.8	2x22	3x22	261	OPEN	680
3.3	0.9	1.2	2x22	3x22	169	200	680
3.3	1	1.3	2x22	2x22	154	150	820
3.3	1.2	1.5	2x22	2x22	130	100	680
3.3	1.5	1.9	2x22	2x22	102	66.5	390
3.3	1.8	2	2x22	2x22	95.3	49.9	390
3.3	2.5	2	2x22	2x22	95.3	31.6	220



FIGURE 2. TOP OF BOARD



FIGURE 3. BOTTOM OF BOARD

Recommended Equipment

- 0V to 5.5V power supply with at least 5A source current capability
- Electronic load capable of sinking current up to 3A
- Digital Multimeters (DMMs)
- 100MHz quad-trace oscilloscope

Functional Description

The ISL8202M is a single 3A step-down high efficiency power module optimized for FPGA, DSP, and Li-ion battery power devices. The module switches at 1.8MHz by default when the FS pin is shorted to V_{IN}. The switching frequency is also adjustable from 680kHz to 3.5MHz through a resistor from FS to SGND. To boost light-load efficiency, the ISL8202M can also be configured to operate in PFM mode by pulling the SYNC pin to SGND. The peak current mode control scheme is implemented for fast

transient response. The module utilizes internal compensation to stabilize the system and optimize transient response, which greatly simplifies the application. Other excellent features include external synchronization, 100% duty cycle operation, and very low quiescent current. For more information, refer to the [ISL8202M](#) datasheet.

Quick Start

The ISL8202MEVAL1Z is set to be V_{OUT} = 1.2V, f_{SW} = 1.5MHz by default. For other V_{OUT} options, the recommended f_{SW} needs to be adjusted by changing resistor (R₇) connected to the FS pin. Please refer to [Table 1](#) for more information. The following operation procedure will be based on default settings.

1. Before applying power to input, ensure one shorting jumper on J1 across pins 5 and 6 is present. This selects the V_{OUT} = 1.2V option.
2. Set the ENABLE switches SW1 to the "OFF" position.

3. Connect the positive of a power supply to the VIN connector and the negative of the power supply to the PGND connector. Make sure the power supply is not enabled when making connections and the input power supply voltage is set to a value between 2.6V and 5.5V.
4. Turn the power supply on.
5. Turn ENABLE switch SW1 to the "ON" position to enable module operation.
6. The power-good LED should illuminate in green if the module is operating properly.
7. Measure output voltage, V_{OUT} , at test points VOUT and PGND. The module output should be 1.2V.

Programming the Output Voltage

The ISL8202MEVAL1Z evaluation board has several preset output voltages, 1.0V, 1.2V, 2.5V, and 3.3V, which can be selected in jumper J1. Other V_{OUT} values other than on-board options can be set by proper selection of the resistor (R_{SET}) connecting from FB to SGND. In this case, R_{SET} for default options (R_9 , R_{10} , R_{11} , R_{12}) may need to be changed. The output voltage is governed by [Equation 1](#).

$$V_{OUT} = V_{REF} \cdot \frac{R_{SET} + 100k\Omega}{R_{SET}} \quad (\text{EQ. 1})$$

For the most common V_{OUT} values and corresponding R_{SET} values, please refer to [Table 1 on page 2](#) for more information.

Feed-Forward Capacitor Selection

In typical applications where the output capacitors are all ceramic, a feed-forward capacitor, C_{FF} (as annotated as C_{12} , C_{13} , C_{14} , C_{15} in schematic) is needed to be put in parallel with each R_{SET} to insure loop stability in extreme operating conditions. With internal compensation mode enabled, the C_{FF} values for typical operating conditions are optimized and listed in [Table 1](#). This is how C_{12} , C_{13} , C_{14} and C_{15} default values are selected. Please note that, for system parameters that are different from [Table 1](#) or external instead of internal compensation is used, the optimized value of C_{FF} needs to be adjusted.

Frequency Adjust

The switching frequency of the ISL8202M is adjustable ranging from 680kHz to 3.5MHz via a simple resistor R_{FS} (as shown in R_7 on ISL8202MEVAL1Z board) across FS to SGND. The switching frequency setting is based on [Equation 2](#):

$$R_{FS}[k\Omega] = \frac{220 \cdot 10^3}{f_{OSC}[kHz]} - 14 \quad (\text{EQ. 2})$$

When the FS pin is directly tied to VIN, the frequency of operation is fixed at 1.8MHz. For a recommended switching frequency with typical operation conditions, refer to [Table 1](#). More detailed information on recommended switching frequency and f_{SW} selection range is provided in "[Recommended Switching Frequency](#)" and "[Operation Range](#)".

Recommended Switching Frequency

The switching frequency for each V_{IN} and V_{OUT} combination needs to take into account a few trade-offs. Generally, a lower switching frequency will lead to higher efficiency. However, the switching frequency should not be decreased too low due to negative current protection limit. Moreover, when output voltage is relatively high, low switching frequency will result in more sub-harmonic oscillation. Therefore, the operating frequency needs to be kept relatively high under high V_{OUT} conditions. However, switching frequency cannot be increased too much, or the minimum on-time limit could be violated. Based on these considerations, [Figure 4](#) provides the recommended switching frequency under various typical V_{IN} and across V_{OUT} ranges.

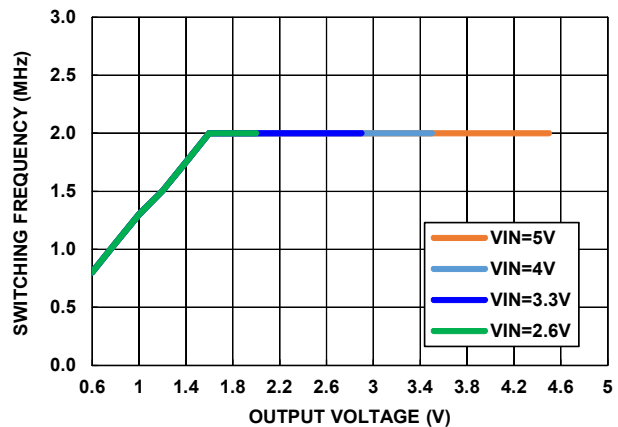

FIGURE 4. SWITCHING FREQUENCY RECOMMENDATION

Operation Range

By default, the ISL8202MEVAL1Z is configured to operate at $V_{OUT} = 1.2V$ (J1 jumper position is at pins 5 and 6), $f_{SW} = 1.5MHz$ conditions. The V_{IN} ranges from 2.6V to 5.5V. The board can also support a wider operating range to meet the requirement of specific applications. V_{OUT} can be adjusted from 0.6V to 5V. Load current range is from 0A to 3A. Note that, for continuous operation at 3A, airflow across the board may be needed. The f_{SW} can also be tuned. However, to ensure sufficient stability margins, switching frequency can only be adjusted within the safe operating regions represented with [Figures 5](#) through [9](#). Operating outside of these areas may lead to system instability.

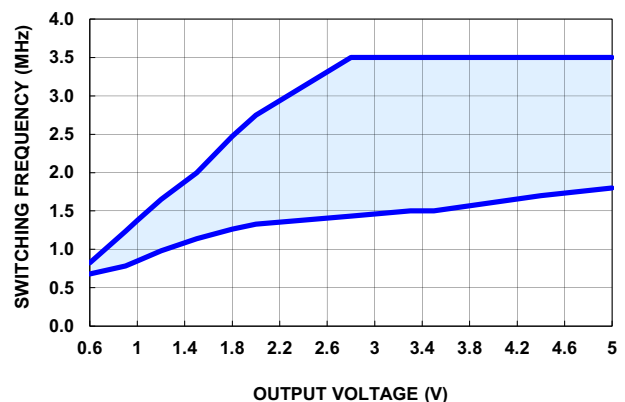
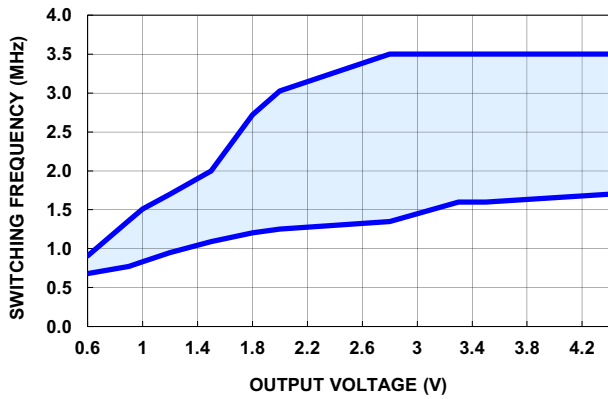
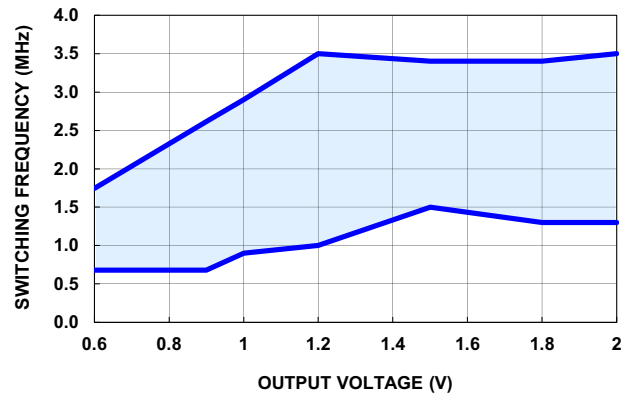
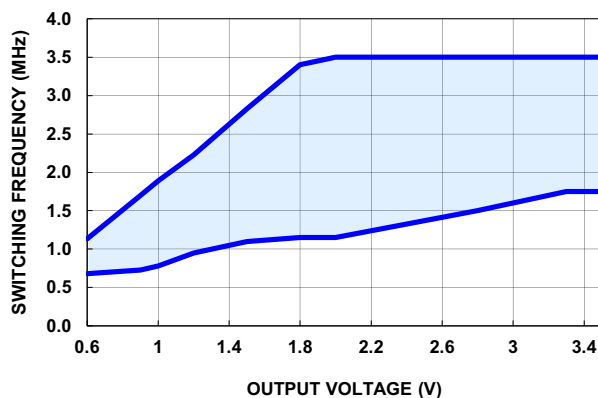
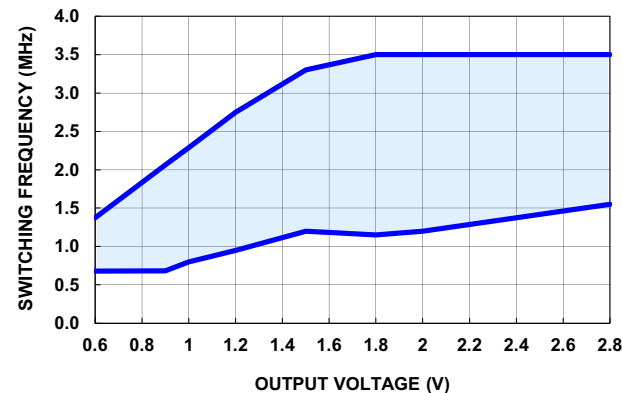

FIGURE 5. OPERATION REGION $V_{IN} = 5.5V$

FIGURE 6. OPERATION REGION $V_{IN} = 5.0V$ FIGURE 9. OPERATION REGION $V_{IN} = 2.6V$ FIGURE 7. OPERATION REGION $V_{IN} = 4.0V$ FIGURE 8. OPERATION REGION $V_{IN} = 3.3V$

PWM/PFM Selection

By default, the ISL8202MEVAL1Z is set to operate in PWM mode. This is achieved by connecting SYNC to VIN through R_1 . Pulling the SYNC pin LOW forces the module into PFM mode, which enables pulse-skipping at light load to minimize the switching loss by reducing the switching frequency. Refer to the [ISL8202M](#) datasheet for more detailed information. PFM mode can be enabled by removing R_1 and shorting SYNC to SGND by putting a 0Ω resistor on R_2 .

Soft Start-Up

The soft start-up reduces the inrush current during start-up. The soft start-up time is set to 1ms by default through C_6 . However, start-up time can be adjusted by tuning the C_6 value. [Equation 3](#) can be used to determine the C_6 value for the target soft-start time t_{SS} .

$$C_6[\mu F] = 3.1 \times t_{SS}[S] \quad (\text{EQ. 3})$$

Evaluation Board Information

The ISL8202MEVAL1Z evaluation board is a 2x2 in² four-layer FR-4 board with 2oz. copper on all the layers. The board can be used as a single 3A reference design. Refer to [Figures 11](#) through [14](#) for board layout information. The board is designed with mechanical switches for ENABLE, power-good LED indicators, several connectors, test points and jumpers, which makes testing the board easy.

Thermal Considerations and Current Derating

Proper board layout is critical in order to make the module operate safely and deliver maximum allowable power. In order for the board to operate properly in the high ambient temperature environments and carry full load currents, the board layout needs to be carefully designed to maximize thermal performance. To achieve this, select enough trace width, copper weight and proper connectors.

The ISL8202MEVAL1Z evaluation board is capable of operating at 3A full load current at room temperature with plenty of safety margin for junction temperature. However, if the board is to operate at elevated ambient temperatures, then the available output current may need to be derated. Refer to the derated current curves in the [ISL8202M](#) datasheet to determine the maximum output current the evaluation board can supply.

ISL8202MEVAL1Z Schematic

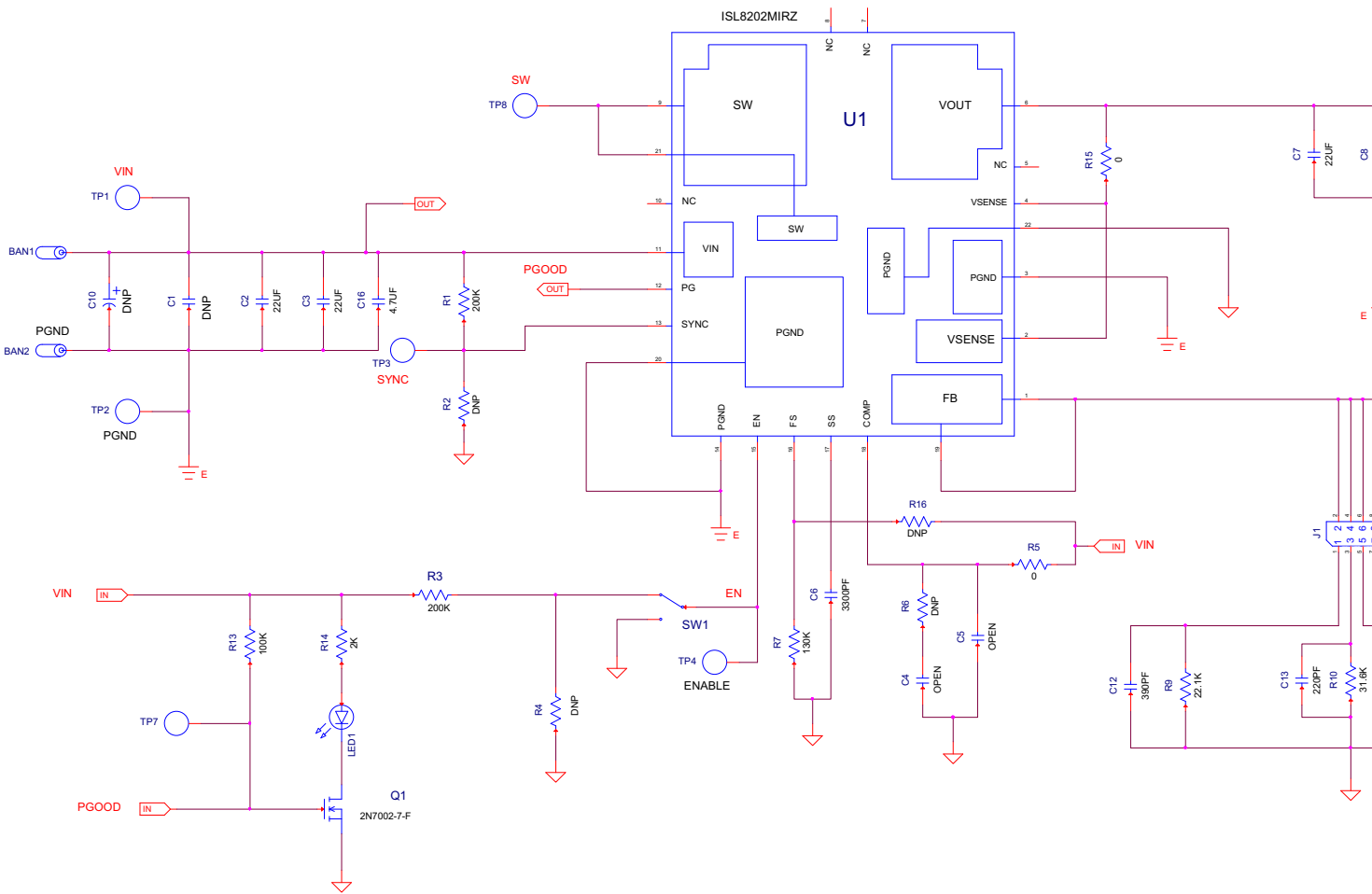

FIGURE 10. SCHEMATIC

Bill of Materials

REFERENCE DESIGNATOR	QTY	MANUFACTURER	PART NUMBER	DESCRIPTION
C16	1	MURATA	GRM21BR71A475KA73L	CAP, SMD, 0805, 4.7µF, 10V, 10%, X7R, ROHS
C13	1	PANASONIC	ECU-E1H221JCQ	CAP, SMD, 0402, 220pF, 50V, 5%, COG, ROHS
C6	1	PANASONIC	ECU-E1E332KBQ	CAP, SMD, 0402, 3300pF, 25V, 10%, X7R, ROHS
C12	1	YAGEO	CC0402JRNPO9BN391	CAP, SMD, 0402, 390pF, 50V, 5%, NPO, ROHS
C14	1	YAGEO	CC0402JRNPO9BN681	CAP, SMD, 0402, 680pF, 50V, 5%, NPO, ROHS
C15	1	SAMSUNG	CL05C821JB5NNNC	CAP, SMD, 0402, 820pF, 50V, 5%, NPO, ROHS
C4, C5	0			CAP, SMD, 0402, DNP-PLACE HOLDER, ROHS
C2, C3, C7, C8	4	TAIYO YUDEN	LMK316AB7226KL-TR	CAP, SMD, 1206, 22µF, 10V, 10%, X7R, ROHS
C1, C9	2			CAP, SMD, 1206, DNP-PLACE HOLDER, ROHS
TP1-TP8	8	KEYSTONE	5002	CONN-MINI TEST POINT, VERTICAL, WHITE, ROHS
BAN1-BAN4	4	KEYSTONE	575-4	CONN-JACK, MINI BANANA, 0.175 PLUG, NICKEL/BRASS, ROHS
J1	1	BERG/FCI	68000-236HLF	CONN-HEADER, 1x8, BRKAWY 1x36, 2.54mm, ROHS
J1-Pins 5-6	1	SULLINS	SPC02SYAN	CONN-JUMPER, SHORTING, 2PIN, BLACK, GOLD, ROHS
LED1	1	LITEON/VISHAY	LTST-C190KGKT	LED, SMD, 0603, GREEN CLEAR, 2V, 20mA, 571nm, 35mcd, ROHS
U1	1	INTERSIL	ISL8202MIRZ	IC-3A PWR MODULE, ANALOG DC/DC, 22P, QFN, 4.5x7.5, ROHS
Q1	1	DIODES, INC.	2N7002-7-F	TRANSISTOR, N-CHANNEL, 3LD, SOT-23, 60V, 115mA, ROHS
R7	1	TE CONNECTIVITY	3-1879216-1	RES, SMD, 0402, 130k, 1/16W, 0.1%, TF, ROHS
R12	1	TE CONNECTIVITY	3-1879216-2	RES, SMD, 0402, 150k, 1/16W, 0.1%, TF, ROHS
R9	1	TE CONNECTIVITY	6-1879215-6	RES, SMD, 0402, 22.1k, 1/16W, 0.1%, TF, ROHS
R11	1	TE CONNECTIVITY	9-1879208-7	RES, SMD, 0402, 100k, 1/16W, 0.1%, TF, ROHS
R4	0			RES, SMD, 0603, 0.1%, MF, DNP-PLACE HOLDER
R5, R15	2	VENKEL	CR0402-16W-00T	RES, SMD, 0402, 0Ω, 1/16W, 5%, TF, ROHS
R1	1	ROHM	MCR01MZPF2003	RES, SMD, 0402, 200k, 1/16W, 1%, TF, ROHS
R2, R6, R16	0			RES, SMD, 0402, DNP, DNP, DNP, TF, ROHS
R13	1	VENKEL	CR0603-10W-1003FT	RES, SMD, 0603, 100k, 1/10W, 1%, TF, ROHS
R14	1	KOA	RK73H1JTTD2001F	RES, SMD, 0603, 2k, 1/10W, 1%, TF, ROHS
R3	1	VENKEL	CR0603-10W-2003FT	RES, SMD, 0603, 200k, 1/10W, 1%, TF, ROHS
R10	1	YAGEO	RT0402BRD0731K6L	RES, SMD, 0402, 31.6k, 1/16W, 0.1%, TF, ROHS
SW1	1	ITT INDUSTRIES/C&K DIVISION	GT11MSCBE	SWITCH-TOGGLE, SMD, 6PIN, SPDT, 2POS, ON-NONE-ON, ROHS
C10	0			CAP, TANT, SMD, 2917, 10V, DNP-PLACE HOLDER
C11	0			CAP, TANT POLY, SMD, 2917, 10V, DNP-PLACE HOLDER

Board Layout

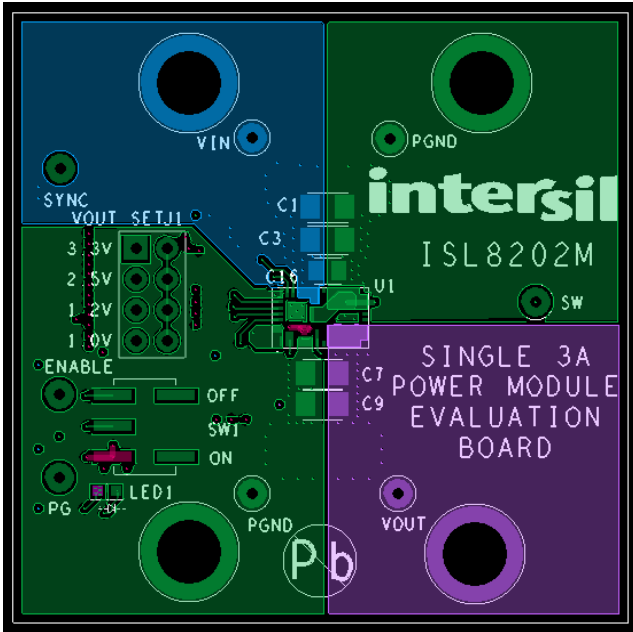

FIGURE 11. TOP LAYER (TOP VIEW)

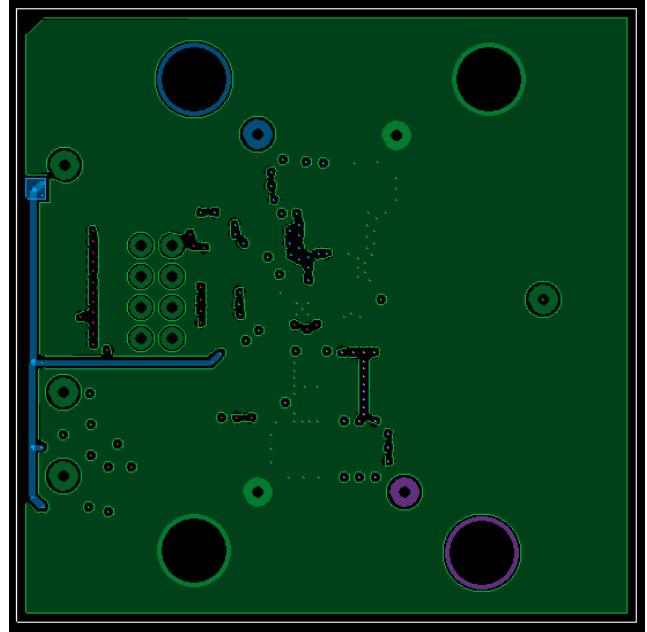

FIGURE 12. INNER LAYER 1 (TOP VIEW)

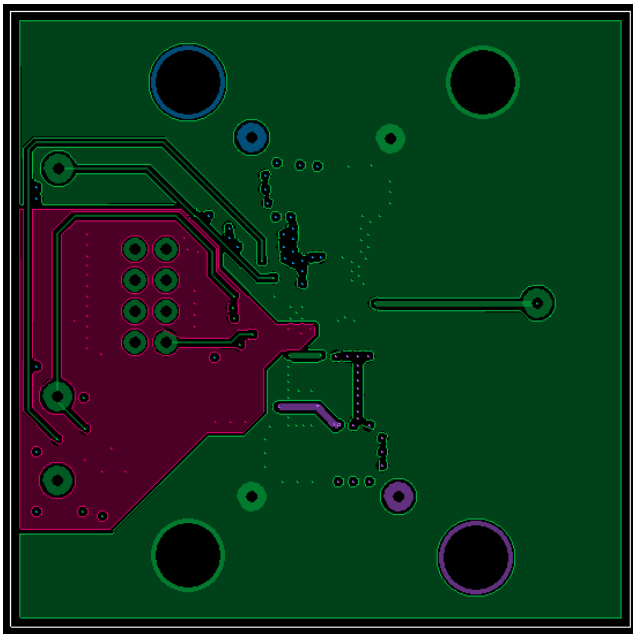

FIGURE 13. INNER LAYER 2 (TOP VIEW)

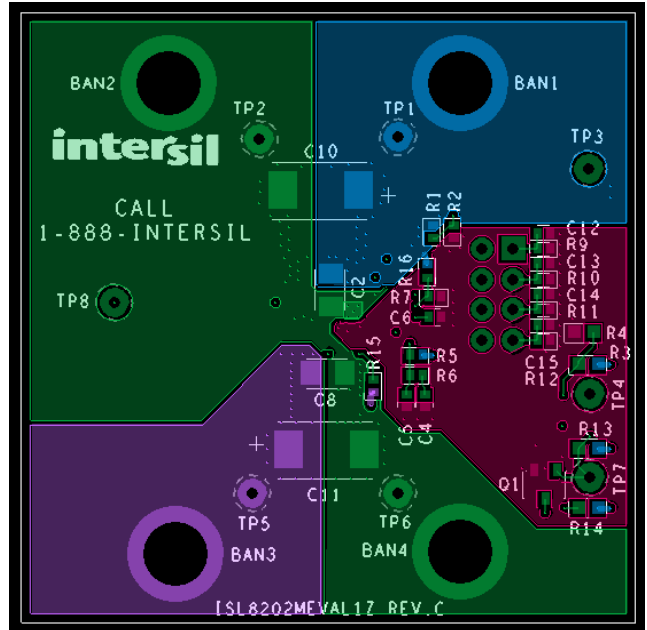

FIGURE 14. BOTTOM LAYER (BOTTOM VIEW)

ISL8202MEVAL1Z Performance Data

The following data was acquired using a ISL8202MEVAL1Z evaluation board at +25°C ambient and free air OLFM.

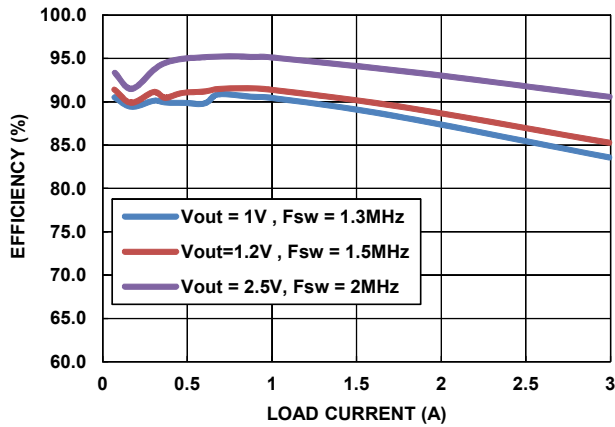

FIGURE 15. EFFICIENCY $T_A = +25^\circ\text{C}$, $V_{IN} = 3.3\text{V}$ PFM MODE

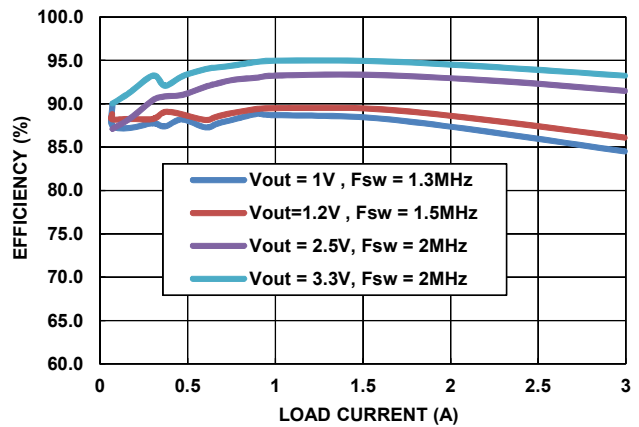

FIGURE 16. EFFICIENCY $T_A = +25^\circ\text{C}$, $V_{IN} = 5\text{V}$ PFM MODE

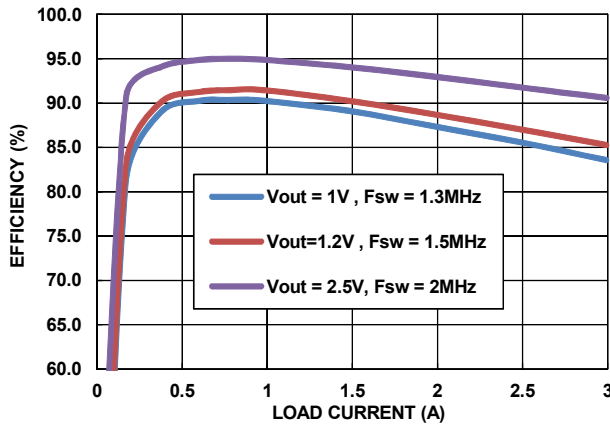

FIGURE 17. EFFICIENCY $T_A = +25^\circ\text{C}$, $V_{IN} = 3.3\text{V}$ PWM MODE

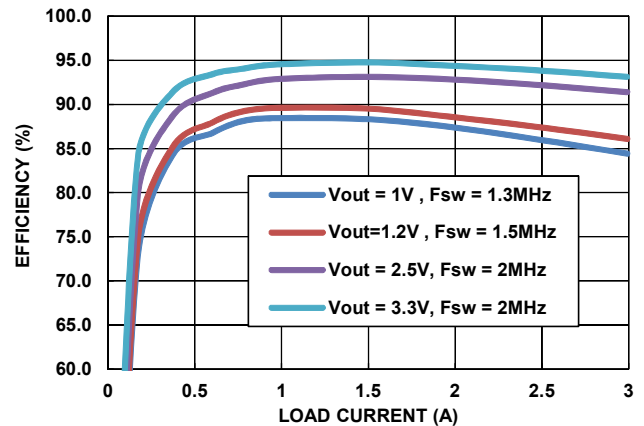

FIGURE 18. EFFICIENCY $T_A = +25^\circ\text{C}$, $V_{IN} = 5\text{V}$ PWM MODE

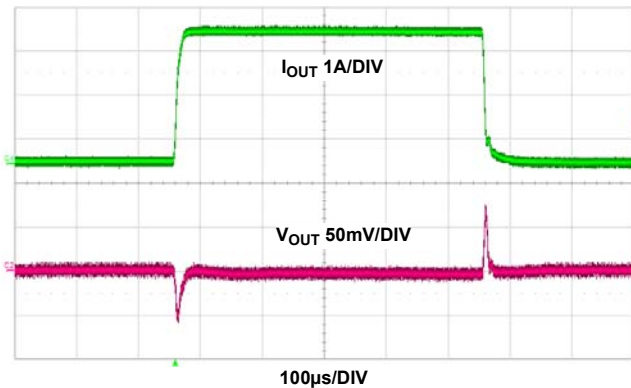

FIGURE 19. LOAD TRANSIENT $V_{IN} = 5\text{V}$, $V_{OUT} = 1.2\text{V}$, $I_{OUT} = 0$ TO 3A , $f_{SW} = 1.5\text{MHz}$, $C_{OUT} = 2 \times 22\mu\text{F}$ CERAMIC CAPACITORS, LOAD CURRENT SLEW RATE: $1\text{A}/\mu\text{s}$

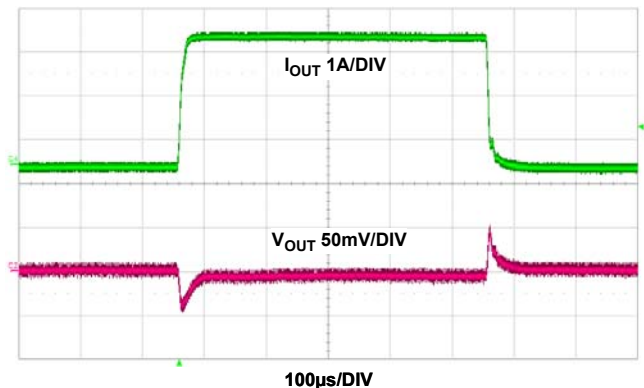

FIGURE 20. LOAD TRANSIENT $V_{IN} = 5\text{V}$, $V_{OUT} = 3.3\text{V}$, $I_{OUT} = 0$ TO 3A , $f_{SW} = 2\text{MHz}$, $C_{OUT} = 2 \times 22\mu\text{F}$ CERAMIC CAPACITORS, LOAD CURRENT SLEW RATE: $1\text{A}/\mu\text{s}$

ISL8202MEVAL1Z Performance Data The following data was acquired using a ISL8202MEVAL1Z evaluation board at +25°C ambient and free air OLFM. (Continued)

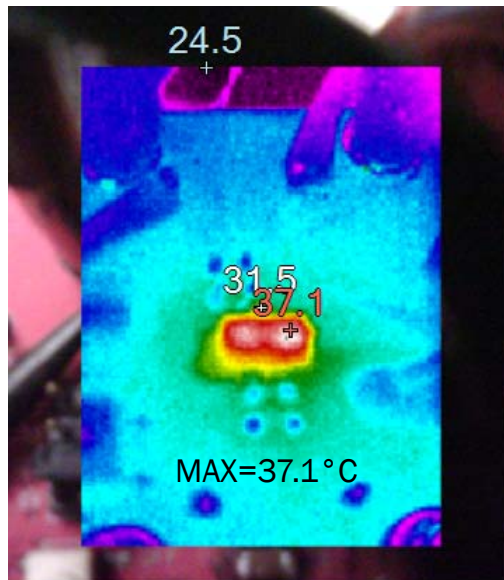

FIGURE 21. THERMAL IMAGE AT $V_{IN} = 5V$, $V_{OUT} = 1.2V$, $I_{OUT} = 3A$, $f_{SW} = 1.5MHz$, $T_A = +25^\circ C$, FREE AIR 0 LFM

© Copyright Intersil Americas LLC 2016. All Rights Reserved.
All trademarks and registered trademarks are the property of their respective owners.

Intersil Corporation reserves the right to make changes in circuit design, software and/or specifications at any time without notice. Accordingly, the reader is cautioned to verify that the document is current before proceeding.

For information regarding Intersil Corporation and its products, see www.intersil.com

X-ON Electronics

Largest Supplier of Electrical and Electronic Components

Click to view similar products for [Power Management IC Development Tools](#) category:

Click to view products by [Renesas](#) manufacturer:

Other Similar products are found below :

[EVAL-ADM1168LQEBZ](#) [EVB-EP5348UI](#) [MIC23451-AAAYFL EV](#) [MIC5281YMME EV](#) [DA9063-EVAL](#) [ADP122-3.3-EVALZ](#) [ADP130-0.8-EVALZ](#) [ADP130-1.2-EVALZ](#) [ADP130-1.5-EVALZ](#) [ADP130-1.8-EVALZ](#) [ADP1714-3.3-EVALZ](#) [ADP1716-2.5-EVALZ](#) [ADP1740-1.5-EVALZ](#) [ADP1752-1.5-EVALZ](#) [ADP1828LC-EVALZ](#) [ADP1870-0.3-EVALZ](#) [ADP1871-0.6-EVALZ](#) [ADP1873-0.6-EVALZ](#) [ADP1874-0.3-EVALZ](#) [ADP1882-1.0-EVALZ](#) [ADP199CB-EVALZ](#) [ADP2102-1.25-EVALZ](#) [ADP2102-1.875EVALZ](#) [ADP2102-1.8-EVALZ](#) [ADP2102-2-EVALZ](#) [ADP2102-3-EVALZ](#) [ADP2102-4-EVALZ](#) [ADP2106-1.8-EVALZ](#) [ADP2147CB-110EVALZ](#) [AS3606-DB](#) [BQ24010EVM](#) [BQ24075TEVM](#) [BQ24155EVM](#) [BQ24157EVM-697](#) [BQ24160EVM-742](#) [BQ24296MEVM-655](#) [BQ25010EVM](#) [BQ3055EVM](#) [NCV891330PD50GEVB](#) [ISLUSBI2CKIT1Z](#) [LM2744EVAL](#) [LM2854EVAL](#) [LM3658SD-AEV/NOPB](#) [LM3658SDEV/NOPB](#) [LM3691TL-1.8EV/NOPB](#) [LM4510SDEV/NOPB](#) [LM5033SD-EVAL](#) [LP38512TS-1.8EV](#) [EVAL-ADM1186-1MBZ](#) [EVAL-ADM1186-2MBZ](#)