

ISL8240MEVAL3Z

40A, Single Output Evaluation Board Setup Procedure

AN1923  
Rev 1.00  
January 28, 2016

**Description**

The [ISL8240M](#) is a complete, dual step-down switching mode DC/DC module. The dual outputs can easily be paralleled for single-output, high-current use. It is easy to apply this high-power, current-sharing DC/DC power module to power-hungry datacom, telecom, and FPGA applications. All that is needed in order to have a complete, 40A design ready for use are the ISL8240M, a few passive components, and  $V_{OUT}$  setting resistors.

The ease of use virtually eliminates design and manufacturing risks while dramatically improving time to market.

The simplicity of the ISL8240M is its off-the-shelf, unassisted implementation. Patented module structure allows for higher power density and better efficiency than competing solutions. Patented current sharing in multi-phase operation greatly reduces ripple currents, BOM costs, and complexity.

The ISL8240MEVAL3Z evaluation board enables a single output by paralleling two phases to deliver 40A continuous load current. To evaluate the dual output configuration of the ISL8240M, please refer to application note [AN1922](#), "ISL8240MEVAL4Z Dual 20A/Optional 40A Cascadable Evaluation Board Setup Procedure." The ISL8240M supports input voltage from 4.5V to 20V and the output voltage ranges from 0.6V to 2.5V. With the single resistor modification, the output voltage can be easily adjusted to different voltages.

**Related Resources**

- [ISL8240M](#) datasheet.

**Board Features**

- Small, compact, and simple design
- Connectors, test points, and jumpers for easy probing

**Specifications**

This evaluation board is designed to operate at the following operating conditions:

- Input voltage range from 4.5V to 20V
- Resistor programmable output voltage range from 0.6V to 2.5V (default 1.0V)
- 20A output current if  $V_{OUT}$  is below 1.5V (output current may need to be derated for certain conditions if  $V_{OUT}$  is 1.5V or above 1.5V)
- Switching frequency range from 350kHz to 700kHz (500kHz by default)
- Operating temperature range:  $-40^{\circ}\text{C}$  to  $+85^{\circ}\text{C}$

**Recommended Equipment**

- 0V to 20V power supply with at least 10A source current capability
- Electronic load capable of sinking current up to 40A
- Digital Multimeters (DMMs)
- 100MHz quad-trace oscilloscope



FIGURE 1. ISL8240MEVAL3Z BOARD IMAGE

## Quick Start

The inputs are J1 (VIN) and J2 (GND). The outputs are J3 (VOUT) and J4 (GND). Refer to [Figure 1](#) for connections.

1. Connect a power supply capable of sourcing at least 10A to the input J1 (VIN) and J2 (GND) of the ISL8240MEVAL3Z evaluation board, with a voltage between 4.5V to 20V. Connect an electronic load or the device to be powered to the output J3 (VOUT) and J4 (GND) of the board. All connections, especially the low voltage, high current V<sub>OUT</sub> lines, should be able to carry the desired load current and should be made as short as possible.
2. Turn on the power supply. Measure the output voltage, V<sub>OUT</sub>, which should be at 1.0V if the board is working properly.
3. The ISL8240MEVAL3Z is manufactured with a default V<sub>OUT</sub> value of 1.0V; if different output voltages are desired, board resistors can be changed to provide the desired V<sub>OUT</sub>. Please refer to the table printed on the backside of the evaluation board or [Table 1](#) for R<sub>VSET</sub> resistor values, which can be used to produce different output voltages

The switching frequency is set to 500kHz by default. For V<sub>OUT</sub> higher than 1.0V, the switching frequency will need to be adjusted as shown in [Table 1](#). If the output voltage is set to 1.5V or higher than 1.5V, the output current will need to be derated to allow for safe operation at elevated ambient temperatures. Please refer to the derating curves in the [ISL8240M](#) datasheet.

For V<sub>IN</sub> < 5.5V, please tie VIN directly to VCC for best efficiency. Also, it is preferred that the EN/FF voltage be higher than 1.5V in order to achieve better stability.

**TABLE 1. RESISTANCE SETTING FOR DIFFERENT OUTPUT VOLTAGES AND OPERATING FREQUENCY (R<sub>3</sub> = 1k)**

V <sub>OUT</sub> (V)	R <sub>VSET</sub> (Ω)	FREQUENCY (kHz)	R <sub>FSET</sub> (kΩ)
1.0	Default (1500)	Default (500)	Default (237)
1.2	1000	550	174
1.5	665	600	140
1.8	499	650	115
2.5	316	700	100

## Evaluation Board Information

The evaluation board size is 3 inchx3 inch. It is a 6-layer board, containing 2-ounce copper on the top and bottom layers and 1-ounce copper on all internal layers. The board can be used as a 40A reference design, refer to [“Layout” on page 4](#). The board is made up of FR4 material and all components, including the solder attachment, are lead-free.

## Thermal Considerations and Current Derating

For high current applications, board layout is very critical in order to make the module operate safely and deliver maximum allowable power. To carry large currents, the board layout needs to be carefully designed to maximize thermal performance. To achieve this, select enough trace width, copper weight and the proper connectors.

This evaluation board is designed for running 40A, 1.0V at room temperature without additional cooling systems needed.

However, if the output voltage is increased or the board is operated at elevated temperatures, then the available current needs to be derated. Refer to the current derating curves in the [ISL8240M](#) datasheet to determine the output current available.

For layout of designs using the ISL8240M, the thermal performance can be improved by adhering to the following design tips:

1. Use the top and bottom layers to carry the large current. VOUT1, VOUT2, Phase 1, Phase 2, PGND, VIN1 and VIN2 should have large, solid planes. Place enough thermal vias to connect the power planes in different layers under and around the module.
2. Phase 1 and Phase 2 pads are switching nodes that generate switching noise. Keep these pads under the module. For noise-sensitive applications, it is recommended to keep phase pads only on the top and inner layers of the PCB; do not place phase pads exposed to the outside on the bottom layer of the PCB. To improve the thermal performance, the phase pads can be extended in the inner layer, as shown in Phase 1 and Phase 2 pads on layers 4 and 5 (see [Figures 7](#) and [8](#)) for this 40A evaluation board. Make sure that layers 3 and 6 have the GND layers to cover the extended areas of phase pads on layers 4 and 5 to avoid noise coupling.
3. To avoid noise coupling, we recommend adding 470pF capacitors on all COMP pins of each module for multiple module operations.
4. If the ambient temperature is high or the board space is limited, airflow is needed to dissipate more heat from the modules. A heat sink can also be applied to the top side of the module to further improve the thermal performance (heat sink recommendation: Aavid Thermalloy, part number 375424B00034G, [www.aavid.com](http://www.aavid.com)).

# ISL8240MEVAL3Z Board Schematic

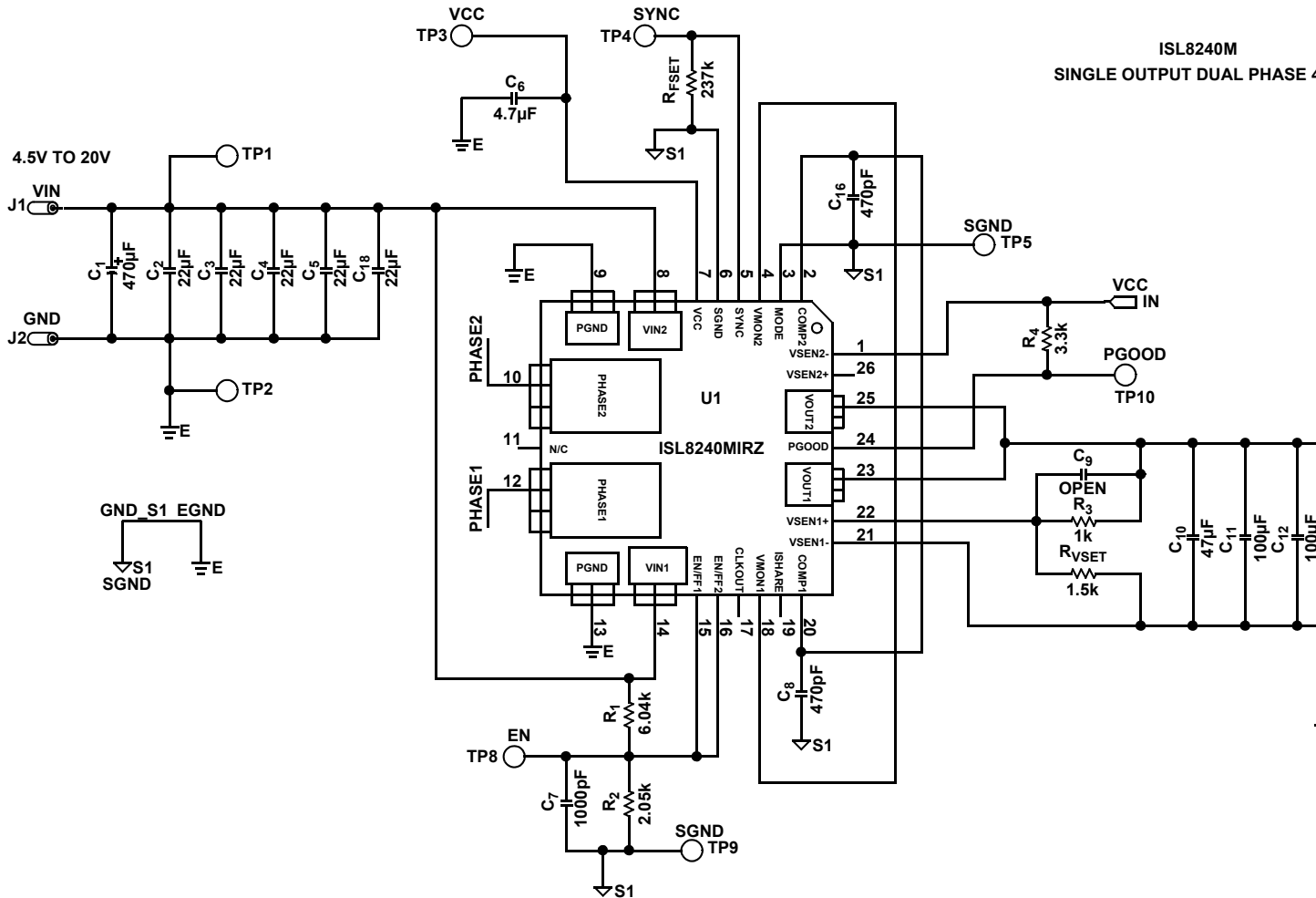

FIGURE 2. ISL8240MEVAL3Z BOARD SCHEMATIC

# Layout

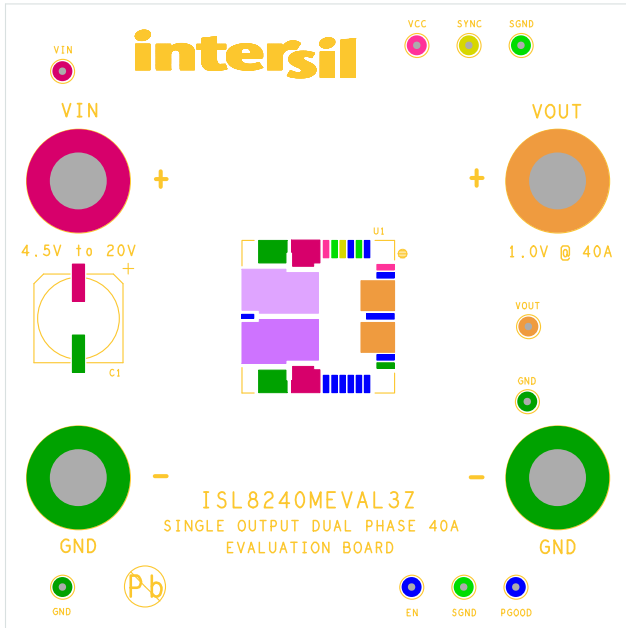

FIGURE 3. SILKSCREEN TOP

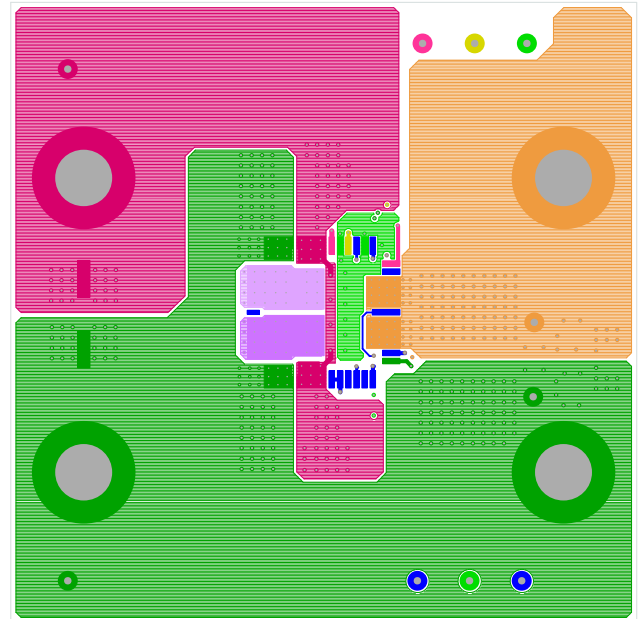

FIGURE 4. TOP LAYER COMPONENT

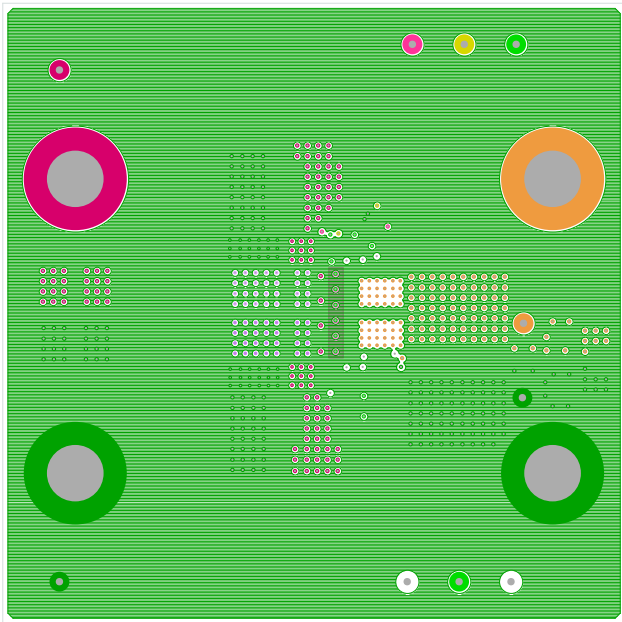

FIGURE 5. LAYER 2

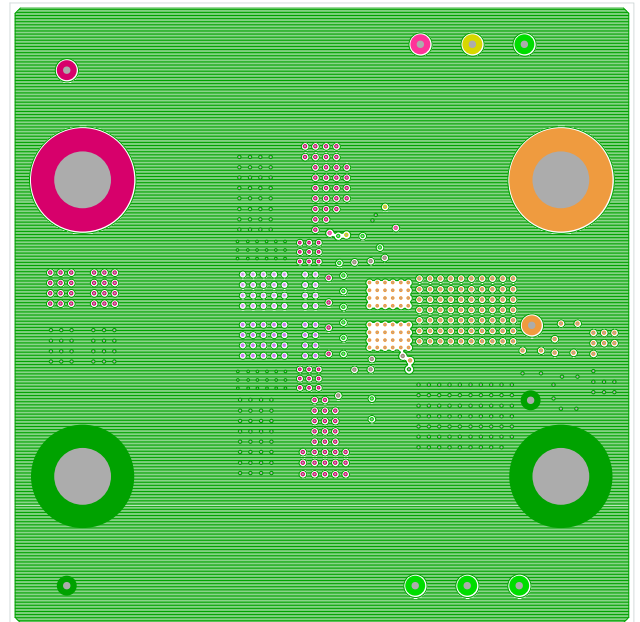

FIGURE 6. LAYER 3

**Layout (Continued)**

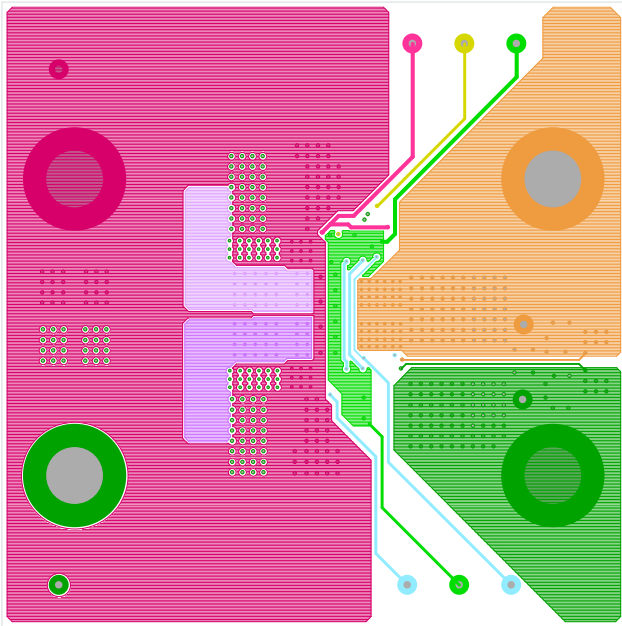

FIGURE 7. LAYER 4

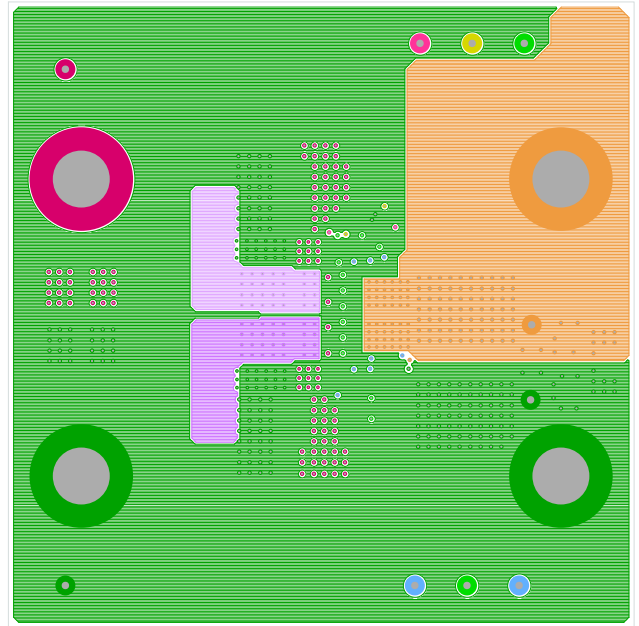

FIGURE 8. LAYER 5

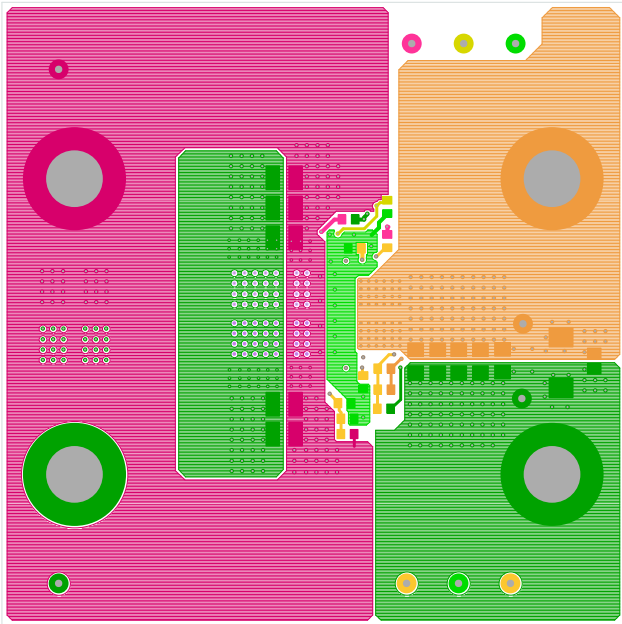

FIGURE 9. BOTTOM LAYER SOLDER SIDE

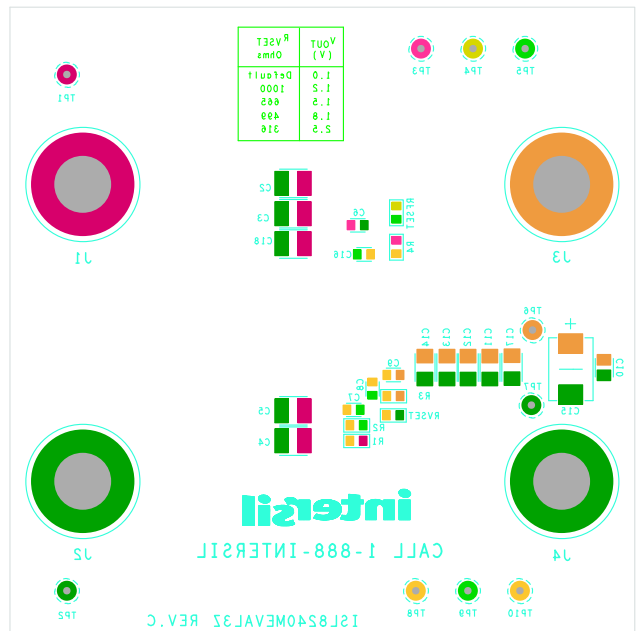

FIGURE 10. SILKSCREEN BOTTOM

## Bill of Materials

MANUFACTURER PART NUMBER	REF DES	QTY.	VALUE	TOL.	VOLTAGE	POWER	PACKAGE TYPE	JEDEC TYPE	MANUFACTURER	
108-0740-001	J1-J4	4					CONN	BAN-JACK	Johnson Components	Standard type ba
10TPB330M	C15	1	330µF	20%	10V		SMD	CAP_7343_149	SANYO-POSCAP	Standard solid e capacitor
5002	TP1-TP10	10					THOLE	MTP500X	Keystone	Miniature white
EEE1EA471P	C1	1	470µF	20%	25V		SMD	CAPAE_393X402	Panasonic	Aluminum elect (RoHS complian
GRM32ER71E226KE15L	C2-C5	4	22µF	10%	25V		1210	CAP_1210	Murata	Ceramic chip ca
H1045-00102-50V10-T	C7	1	1000pF	10%	50V		603	CAP_0603	Generic	Multilayer capac
H1045-00471-50V10	C8, C16	2	470pF	10%	50V		603	CAP_0603	Generic	Multilayer capac
H1045-00475-6R3V10-T	C6	1	4.7µF	10%	6.3V		603	CAP_0603	Generic	Multilayer capac
H1045-OPEN	C9	1	OPEN	5%	OPEN		603	CAP_0603	Generic	Multilayer capac
H1046-00476-6R3V20-T	C10	1	47µF	20%	6.3V		805	CAP_0805	Generic	Multilayer capac
H1065-00107-6R3V20-T	C12-C14	3	100µF	20%	6.3V		1206	CAP_1206	Generic	Multilayer capac
H1065-OPEN	C11	1	OPEN	5%	OPEN		1206	CAP_1206	Generic	Multilayer capac
H2511-02373-1/16W1	RFSET	1	237kΩ	1%		1/16W	603	RES_0603	Generic	Thick filmchip re
H2511-02051-1/10W1-T	R2	1	2.05kΩ	1%		1/10W	603	RES_0603	Generic	Thick filmchip re
H2511-01001-1/16W1	R3, RVSET	2	1kΩ	1%		1/16W	603	RES_0603	Generic	Thick filmchip re
H2511-03301-1/16W5	R4	1	3.3kΩ	5%		1/16W	603	RES_0603	Generic	Thick filmchip re
H2511-06041-1/16W1	R1	1	6.04kΩ	1%		1/10W	603	RES_0603	Generic	Thick filmchip re
ISL8240MIRZ	M1	1					QFN	QFN26_670X670_ISL8240M	Intersil	Dual 20A DC/DC

NOTE: Resistance accuracy of feedback resistor divider R1/R2 can affect the output accuracy. Please use high accuracy resistance (i.e. 0.5% or 0.1%) to meet the

# ISL8240MEVAL3Z Performance

Test conditions at +25°C and no air flow.

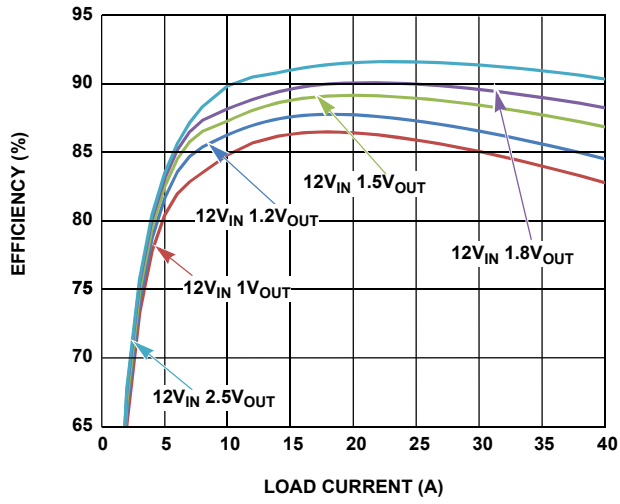

FIGURE 11. EFFICIENCY CURVES FOR 12V INPUT

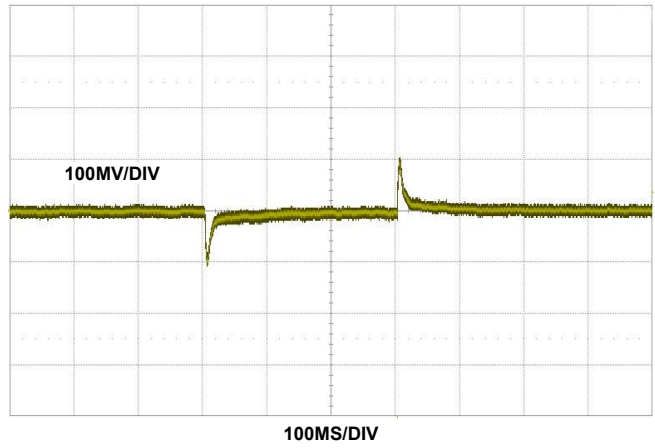

FIGURE 12. 1V<sub>OUT</sub> TRANSIENT RESPONSE, I<sub>OUT</sub> = 0A TO 20A, f<sub>SW</sub> = 350kHz, LOAD CURRENT SLEW RATE: 10A/μs

## Notice

1. Descriptions of circuits, software and other related information in this document are provided only to illustrate the operation of semiconductor products and application examples. You are fully responsible for the incorporation or any other use of the circuits, software, and information in the design of your product or system. Renesas Electronics disclaims any and all liability for any losses and damages incurred by you or third parties arising from the use of these circuits, software, or information.
2. Renesas Electronics hereby expressly disclaims any warranties against and liability for infringement or any other claims involving patents, copyrights, or other intellectual property rights of third parties, by or arising from the use of Renesas Electronics products or technical information described in this document, including but not limited to, the product data, drawings, charts, programs, algorithms, and application examples.
3. No license, express, implied or otherwise, is granted hereby under any patents, copyrights or other intellectual property rights of Renesas Electronics or others.
4. You shall not alter, modify, copy, or reverse engineer any Renesas Electronics product, whether in whole or in part. Renesas Electronics disclaims any and all liability for any losses or damages incurred by you or third parties arising from such alteration, modification, copying or reverse engineering.
5. Renesas Electronics products are classified according to the following two quality grades: "Standard" and "High Quality". The intended applications for each Renesas Electronics product depends on the product's quality grade, as indicated below.  
"Standard": Computers; office equipment; communications equipment; test and measurement equipment; audio and visual equipment; home electronic appliances; machine tools; personal electronic equipment; industrial robots; etc.  
"High Quality": Transportation equipment (automobiles, trains, ships, etc.); traffic control (traffic lights); large-scale communication equipment; key financial terminal systems; safety control equipment; etc.  
Unless expressly designated as a high reliability product or a product for harsh environments in a Renesas Electronics data sheet or other Renesas Electronics document, Renesas Electronics products are not intended or authorized for use in products or systems that may pose a direct threat to human life or bodily injury (artificial life support devices or systems; surgical implantations; etc.), or may cause serious property damage (space system; undersea repeaters; nuclear power control systems; aircraft control systems; key plant systems; military equipment; etc.). Renesas Electronics disclaims any and all liability for any damages or losses incurred by you or any third parties arising from the use of any Renesas Electronics product that is inconsistent with any Renesas Electronics data sheet, user's manual or other Renesas Electronics document.
6. When using Renesas Electronics products, refer to the latest product information (data sheets, user's manuals, application notes, "General Notes for Handling and Using Semiconductor Devices" in the reliability handbook, etc.), and ensure that usage conditions are within the ranges specified by Renesas Electronics with respect to maximum ratings, operating power supply voltage range, heat dissipation characteristics, installation, etc. Renesas Electronics disclaims any and all liability for any malfunctions, failure or accident arising out of the use of Renesas Electronics products outside of such specified ranges.
7. Although Renesas Electronics endeavors to improve the quality and reliability of Renesas Electronics products, semiconductor products have specific characteristics, such as the occurrence of failure at a certain rate and malfunctions under certain use conditions. Unless designated as a high reliability product or a product for harsh environments in a Renesas Electronics data sheet or other Renesas Electronics document, Renesas Electronics products are not subject to radiation resistance design. You are responsible for implementing safety measures to guard against the possibility of bodily injury, injury or damage caused by fire, and/or danger to the public in the event of a failure or malfunction of Renesas Electronics products, such as safety design for hardware and software, including but not limited to redundancy, fire control and malfunction prevention, appropriate treatment for aging degradation or any other appropriate measures. Because the evaluation of microcomputer software alone is very difficult and impractical, you are responsible for evaluating the safety of the final products or systems manufactured by you.
8. Please contact a Renesas Electronics sales office for details as to environmental matters such as the environmental compatibility of each Renesas Electronics product. You are responsible for carefully and sufficiently investigating applicable laws and regulations that regulate the inclusion or use of controlled substances, including without limitation, the EU RoHS Directive, and using Renesas Electronics products in compliance with all these applicable laws and regulations. Renesas Electronics disclaims any and all liability for damages or losses occurring as a result of your noncompliance with applicable laws and regulations.
9. Renesas Electronics products and technologies shall not be used for or incorporated into any products or systems whose manufacture, use, or sale is prohibited under any applicable domestic or foreign laws or regulations. You shall comply with any applicable export control laws and regulations promulgated and administered by the governments of any countries asserting jurisdiction over the parties or transactions.
10. It is the responsibility of the buyer or distributor of Renesas Electronics products, or any other party who distributes, disposes of, or otherwise sells or transfers the product to a third party, to notify such third party in advance of the contents and conditions set forth in this document.
11. This document shall not be reprinted, reproduced or duplicated in any form, in whole or in part, without prior written consent of Renesas Electronics.
12. Please contact a Renesas Electronics sales office if you have any questions regarding the information contained in this document or Renesas Electronics products.  
(Note 1) "Renesas Electronics" as used in this document means Renesas Electronics Corporation and also includes its directly or indirectly controlled subsidiaries.  
(Note 2) "Renesas Electronics product(s)" means any product developed or manufactured by or for Renesas Electronics.

(Rev.4.0-1 November 2017)



### SALES OFFICES

Renesas Electronics Corporation

<http://www.renesas.com>

Refer to "<http://www.renesas.com/>" for the latest and detailed information.

**Renesas Electronics America Inc.**  
1001 Murphy Ranch Road, Milpitas, CA 95035, U.S.A.  
Tel: +1-408-432-8888, Fax: +1-408-434-5351

**Renesas Electronics Canada Limited**  
9251 Yonge Street, Suite 8309 Richmond Hill, Ontario Canada L4C 9T3  
Tel: +1-905-237-2004

**Renesas Electronics Europe Limited**  
Dukes Meadow, Millboard Road, Bourne End, Buckinghamshire, SL8 5FH, U.K  
Tel: +44-1628-651-700, Fax: +44-1628-651-804

**Renesas Electronics Europe GmbH**  
Arcadiastrasse 10, 40472 Düsseldorf, Germany  
Tel: +49-211-6503-0, Fax: +49-211-6503-1327

**Renesas Electronics (China) Co., Ltd.**  
Room 1709 Quantum Plaza, No.27 ZhichunLu, Haidian District, Beijing, 100191 P. R. China  
Tel: +86-10-8235-1155, Fax: +86-10-8235-7679

**Renesas Electronics (Shanghai) Co., Ltd.**  
Unit 301, Tower A, Central Towers, 555 Langao Road, Putuo District, Shanghai, 200333 P. R. China  
Tel: +86-21-2226-0888, Fax: +86-21-2226-0999

**Renesas Electronics Hong Kong Limited**  
Unit 1601-1611, 16/F., Tower 2, Grand Century Place, 193 Prince Edward Road West, Mongkok, Kowloon, Hong Kong  
Tel: +852-2265-6688, Fax: +852-2886-9022

**Renesas Electronics Taiwan Co., Ltd.**  
13F, No. 363, Fu Shing North Road, Taipei 10543, Taiwan  
Tel: +886-2-8175-9600, Fax: +886-2-8175-9670

**Renesas Electronics Singapore Pte. Ltd.**  
80 Bendemeer Road, Unit #06-02 Hyflux Innovation Centre, Singapore 339949  
Tel: +65-6213-0200, Fax: +65-6213-0300

**Renesas Electronics Malaysia Sdn.Bhd.**  
Unit 1207, Block B, Menara Amcorp, Amcorp Trade Centre, No. 18, Jln Persiaran Barat, 46050 Petaling Jaya, Selangor Darul Ehsan, Malaysia  
Tel: +60-3-7955-9390, Fax: +60-3-7955-9510

**Renesas Electronics India Pvt. Ltd.**  
No.777C, 100 Feet Road, HAL 2nd Stage, Indiranagar, Bangalore 560 038, India  
Tel: +91-80-67208700, Fax: +91-80-67208777

**Renesas Electronics Korea Co., Ltd.**  
17F, KAMCO Yangjae Tower, 262, Gangnam-daero, Gangnam-gu, Seoul, 06265 Korea  
Tel: +82-2-558-3737, Fax: +82-2-558-5338



## X-ON Electronics

Largest Supplier of Electrical and Electronic Components

*Click to view similar products for [Power Management IC Development Tools](#) category:*

*Click to view products by [Renesas](#) manufacturer:*

Other Similar products are found below :

[EVAL-ADM1168LQEBZ](#) [EVB-EP5348UI](#) [MIC23451-AAAYFL EV](#) [MIC5281YMME EV](#) [DA9063-EVAL](#) [ADP122-3.3-EVALZ](#) [ADP130-0.8-EVALZ](#) [ADP130-1.2-EVALZ](#) [ADP130-1.5-EVALZ](#) [ADP130-1.8-EVALZ](#) [ADP1714-3.3-EVALZ](#) [ADP1716-2.5-EVALZ](#) [ADP1740-1.5-EVALZ](#) [ADP1752-1.5-EVALZ](#) [ADP1828LC-EVALZ](#) [ADP1870-0.3-EVALZ](#) [ADP1871-0.6-EVALZ](#) [ADP1873-0.6-EVALZ](#) [ADP1874-0.3-EVALZ](#) [ADP1882-1.0-EVALZ](#) [ADP199CB-EVALZ](#) [ADP2102-1.25-EVALZ](#) [ADP2102-1.875EVALZ](#) [ADP2102-1.8-EVALZ](#) [ADP2102-2-EVALZ](#) [ADP2102-3-EVALZ](#) [ADP2102-4-EVALZ](#) [ADP2106-1.8-EVALZ](#) [ADP2147CB-110EVALZ](#) [AS3606-DB](#) [BQ24010EVM](#) [BQ24075TEVM](#) [BQ24155EVM](#) [BQ24157EVM-697](#) [BQ24160EVM-742](#) [BQ24296MEVM-655](#) [BQ25010EVM](#) [BQ3055EVM](#) [NCV891330PD50GEVB](#) [ISLUSBI2CKIT1Z](#) [LM2744EVAL](#) [LM2854EVAL](#) [LM3658SD-AEV/NOPB](#) [LM3658SDEV/NOPB](#) [LM3691TL-1.8EV/NOPB](#) [LM4510SDEV/NOPB](#) [LM5033SD-EVAL](#) [LP38512TS-1.8EV](#) [EVAL-ADM1186-1MBZ](#) [EVAL-ADM1186-2MBZ](#)