

ISL8271M

Digital DC/DC PMBus 33A Module

**NOT RECOMMENDED FOR NEW DESIGNS  
RECOMMENDED REPLACEMENT PART  
ISL8278M**

FN8636  
Rev.4.00  
Aug 17, 2017

The **ISL8271M** is a 33A step-down DC/DC power supply module with an integrated digital PWM controller, synchronous power switches, an inductor, and passives. Only bulk input and output capacitors are needed to finish the design. The 33A of continuous output current can be delivered without the need for airflow or a heatsink. The thermally enhanced HDA module is capable of dissipating heat directly into the PCB.

The ISL8271M uses ChargeMode™ control architecture, which responds to a transient load within a single switching cycle. The ISL8271M comes with a preprogrammed configuration for operating in a pin-strap mode: the output voltage, switching frequency, and the device SMBus address can be programmed with external resistors. Other configuration options, such as soft-start and fault limits can be programmed or changed using the PMBus compliant serial bus interface. PMBus can be used to monitor voltages, current, temperatures, and fault status. The ISL8271M is supported by PowerNavigator™ software, a Graphical User Interface (GUI) that can be used to configure modules to a desired solution.

The ISL8271M is available in a 40 Ld compact 17mmx19mm HDA module with very low profile height of 3.55mm, suitable for automated assembly by standard surface mount equipment. The ISL8271M is RoHS compliant by exemption.

**Related Literature**

- For a full list of related documents, visit our website
- [ISL8271M](#) product page

**Features**

- Complete digital switch mode power supply
  - Wide  $V_{IN}$  range: 4.5V to 14V
  - Programmable  $V_{OUT}$  range: 0.6V to 5V
- PMBus compliant  $I^2C$  communication interface
  - Programmable  $V_{OUT}$ , margining, UV/OV,  $I_{OUT}$  limit, soft-start/stop, sequencing, and external synchronization
  - Monitor:  $V_{IN}$ ,  $V_{OUT}$ ,  $I_{OUT}$ , temperature, duty cycle, switching frequency, and faults
- ChargeMode control architecture
- $\pm 1.0\%$   $V_{OUT}$  accuracy over line, load, and temperature
- Power-good indicator
- Over-temperature protection
- Internal nonvolatile memory and fault logging
- Patented thermally enhanced HDA package
- Intuitive configuration using [PowerNavigator](#)

**Applications**

- Server, telecom, storage, and datacom
- Industrial/ATE and networking equipment
- General purpose power for ASIC, FPGA, DSP, and memory

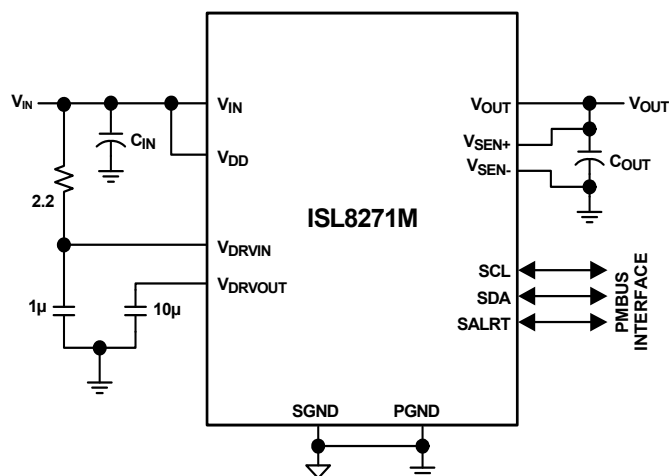

NOTE:

1. Only bulk input and output capacitors are required to finish the design.

FIGURE 1. A COMPLETE DIGITAL SWITCH MODE POWER SUPPLY

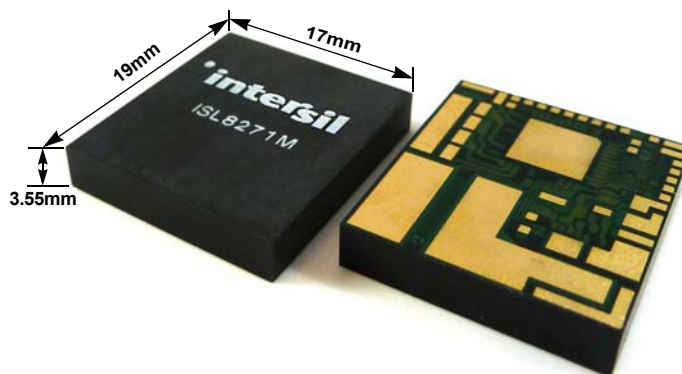

FIGURE 2. A SMALL PACKAGE FOR HIGH POWER DENSITY

# Table of Contents

<b>Ordering Information</b> .....	<b>3</b>
<b>Pin Configuration</b> .....	<b>4</b>
<b>Pin Descriptions</b> .....	<b>4</b>
<b>ISL8271M Internal Block Diagram</b> .....	<b>6</b>
<b>Absolute Maximum Ratings</b> .....	<b>7</b>
<b>Thermal Information</b> .....	<b>7</b>
<b>Recommended Operating Conditions</b> .....	<b>7</b>
<b>Electrical Specifications</b> .....	<b>7</b>
<b>Typical Performance Curves</b> .....	<b>10</b>
Efficiency Performance .....	10
Transient Response Performance .....	11
Derating Curves .....	12
Derating Curves .....	13
<b>Typical Application Circuit</b> .....	<b>14</b>
<b>Functional Description</b> .....	<b>16</b>
SMBus Communications .....	16
Output Voltage Selection .....	16
Soft-Start Delay and Ramp Times .....	16
Power-Good .....	17
Switching Frequency and PLL .....	17
Loop Compensation .....	17
Input Undervoltage Lockout (UVLO) .....	17
SMBus Module Address Selection .....	18
Output Overvoltage Protection .....	18
Output Prebias Protection .....	18
Output Overcurrent Protection .....	19
Thermal Overload Protection .....	19
Digital-DC Bus .....	19
Phase Spreading .....	19
Output Sequencing .....	19
Fault Spreading .....	20
Temperature Monitoring Using XTEMP Pin .....	20
Monitoring Using SMBus .....	20
Snapshot Parameter Capture .....	20
Nonvolatile Memory .....	20
<b>PCB Layout Guidelines</b> .....	<b>21</b>
<b>Thermal Considerations</b> .....	<b>22</b>
Package Description .....	22
PCB Layout Pattern Design .....	22
Thermal Vias .....	22
Stencil Pattern Design .....	22
Reflow Parameters .....	22
<b>PMBus Command Summary</b> .....	<b>23</b>
<b>PMBus Data Formats</b> .....	<b>26</b>
<b>PMBus Use Guidelines</b> .....	<b>27</b>
Summary .....	27
<b>PMBus Command Description</b> .....	<b>27</b>
<b>Revision History</b> .....	<b>49</b>
<b>Firmware Revision History</b> .....	<b>50</b>
<b>About Intersil</b> .....	<b>50</b>
<b>Package Outline Drawing</b> .....	<b>51</b>

## Ordering Information

PART NUMBER (Notes 2, 3, 4)	PART MARKING	FIRMWARE REVISION (Note 5)	TEMP RANGE (°C)	PACKAGE (RoHS Compliant)	PKG. DWG. #
ISL8271MAIRZ	ISL8271M	FC01	-40 to +85	40 Ld 17x19 HDA	Y40.17x19
ISL8271MBIRZ	ISL8271MB	FC02	-40 to +85	40 Ld 17x19 HDA	Y40.17x19
ISL8271MEVAL1Z	Evaluation board				

**NOTES:**

2. Add "-T" suffix for a 500 unit Tape and Reel option. Refer to [TB347](#) for details on reel specifications.
3. These Intersil Pb-free plastic packaged products are RoHS compliant by EU exemption 7C-I and 7A. They employ special Pb-free material sets; molding compounds/die attach materials and NiPdAu plate-e4 termination finish, which is compatible with both SnPb and Pb-free soldering operations. Intersil Pb-free products are MSL classified at Pb-free peak reflow temperatures that meet or exceed the Pb-free requirements of IPC/JEDEC J STD-020.
4. For Moisture Sensitivity Level (MSL), see the product information page for [ISL8271M](#). For more information on MSL, see [TB363](#).
5. See "[Firmware Revision History](#)" on page 50; only the latest firmware revision is recommended for new designs.

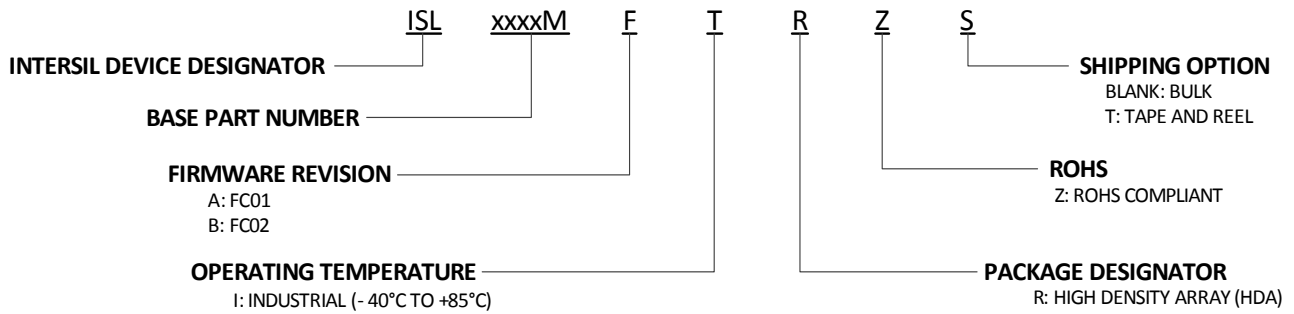

# Pin Configuration

ISL8271M  
(40 LD HDA)  
TOP VIEW

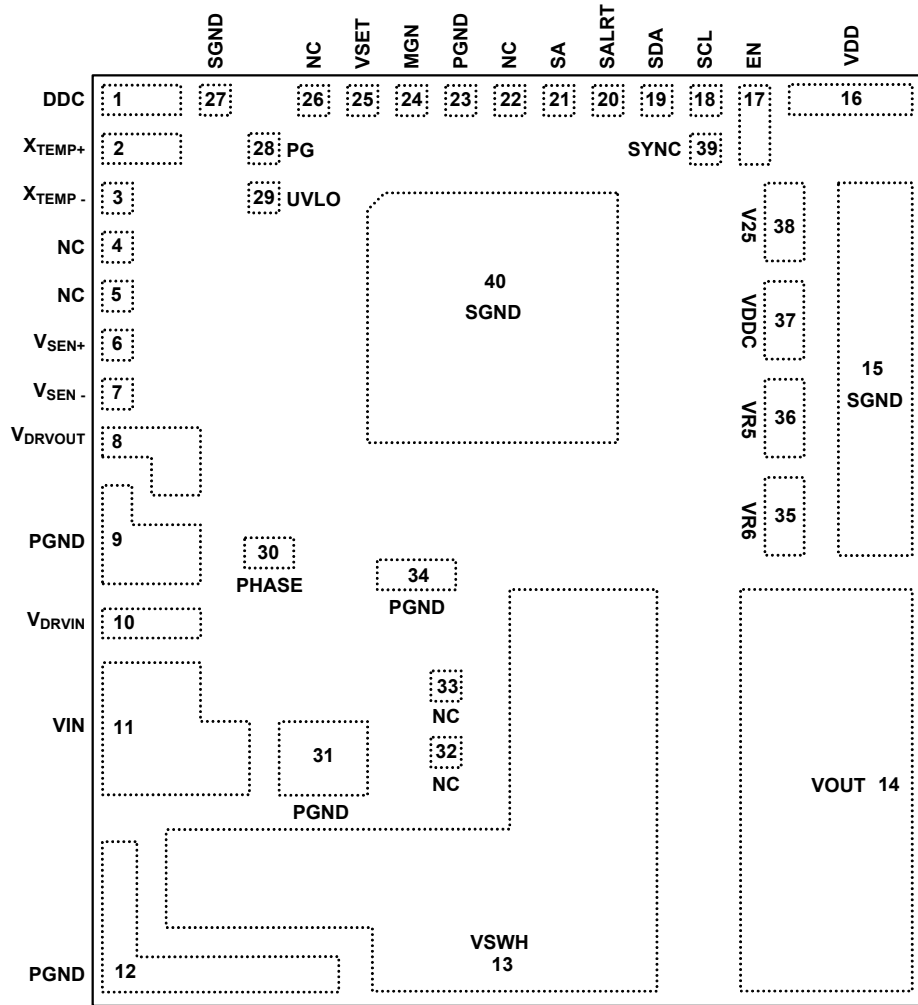

## Pin Descriptions

PIN	LABEL	TYPE	DESCRIPTION
1	DDC	I/O	A Digital-DC™ bus. This dedicated bus provides the communication channel between devices for features such as sequencing and fault spreading. The DDC pin on all Digital-DC devices should be connected together. A pull-up resistor is required for this application.
2	XTEMP+	I	Differential external temperature sensor positive input pin.
3	XTEMP-	I	Differential external temperature sensor negative input pin.
6	VSEN+	I	Differential Output voltage sense feedback. Connect to positive output regulation point.
7	VSEN-	I	Differential Output voltage sense feedback. Connect to negative output regulation point.
8	VDRVOUT	PWR	Output of internal LDO for powering internal gate driver block. Place a 10µF ceramic capacitor at this pin. LDO output is dedicated to powering internal gate driver stage only. Do not use this LDO for any other purpose.
9, 12, 23, 31, 34	PGND	PWR	Power ground. Refer to the <a href="#">"PCB Layout Guidelines" on page 21</a> for the PGND pad connections and decoupling capacitors placement.

## Pin Descriptions (Continued)

PIN	LABEL	TYPE	DESCRIPTION
10	V <sub>DRVIN</sub>	PWR	Input supply to the internal LDO for powering the internal gate driver block. An RC filter is required if VIN supply is shared. Refer to the <a href="#">“PCB Layout Guidelines” on page 21</a> .
11	VIN	PWR	Main input supply. Refer to the <a href="#">“PCB Layout Guidelines” on page 21</a> for the decoupling capacitors placement from VIN to PGND.
13	VSWH	PWR	Switch node. Refer to the <a href="#">“PCB Layout Guidelines” on page 21</a> for connecting VSWH pads to electrically isolated PCB copper island to dissipate internal heat.
14	VO <sub>UT</sub>	PWR	Power supply output. Range: 0.6V to 5V. Refer to <a href="#">“Derating Curves” on page 12</a> for maximum recommended output current at various output voltages.
15, 27, 40	SGND	PWR	Controller Signal ground. Refer to the <a href="#">“PCB Layout Guidelines” on page 21</a> for the SGND pad connections.
16	VDD	PWR	Input supply to digital controller. Connect the VDD pad to the VIN supply. Refer to the <a href="#">“PCB Layout Guidelines” on page 21</a> for the decoupling capacitors placement from VDD to SGND.
17	EN	I	External enable input. Logic high enables the module.
18	SCL	I	Serial clock input. A pull-up resistor is required for this application.
19	SDA	I/O	Serial data. A pull-up resistor is required for this application.
20	SALRT	O	Serial alert. A pull-up resistor is required for this application.
21	SA	I	Serial bus address select pin. Refer to <a href="#">Table 6</a> for list of resistor values to set various serial bus address.
24	MGN	I	External VO <sub>UT</sub> margin control pin. Active high (>2V) signal at this pin sets VO <sub>UT</sub> margin high, Active low (<0.8V) sets VO <sub>UT</sub> margin low and high impedance (float) will bring VO <sub>UT</sub> back to nominal voltage. The factory default range for margining is nominal VO <sub>UT</sub> ±5%. When using PMBus to control margin command, leave this pin as no connect.
25	VSET	I	Output voltage selection pin. Refer to <a href="#">Table 3</a> for list of resistor values to set various output voltages.
28	PG	O	Power-good output. Power-good output can be open drain that requires pull-up resistor or push-pull output that can drive a logic input.
29	UVLO	I	VDD undervoltage lockout selection. Refer to <a href="#">Table 5</a> for list of resistors value to set various UVLO levels.
30	PHASE	PWR	Switch node pad for DCR sensing. Electrically shorted inside to VSWH but for higher current sensing accuracy connect PHASE pad to VSWH pad externally. Refer to the <a href="#">“PCB Layout Guidelines” on page 21</a> .
35	VR6	PWR	6V Internal reference supply voltage.
36	VR5	PWR	5V Internal reference supply voltage.
37	VDDC	PWR	VDD Clean. Noise at the VDD pin is filtered with ferrite bead and capacitor. For V <sub>DD</sub> > 6V, leave this pin as no connect. For 5.5 ≤ V <sub>DD</sub> ≤ 6V, connect the VDDC pin to the VR6 pin. For 4.5 ≤ VDD < 5.5V, connect the VDDC pin to the VR6 and VR5 pin.
38	V25	PWR	2.5V internal reference supply voltage.
39	SYNC	I/O	The SYNC pin can be input to an external clock for frequency synchronization or output to supply a clock signal to other modules for synchronization. Refer to <a href="#">Table 4</a> for list of resistor values to program various switching frequencies.
4, 5, 22, 26, 32, 33	NC		Test pins. These pins are not electrically isolated. Leave these pins as no connect.

# ISL8271M Internal Block Diagram

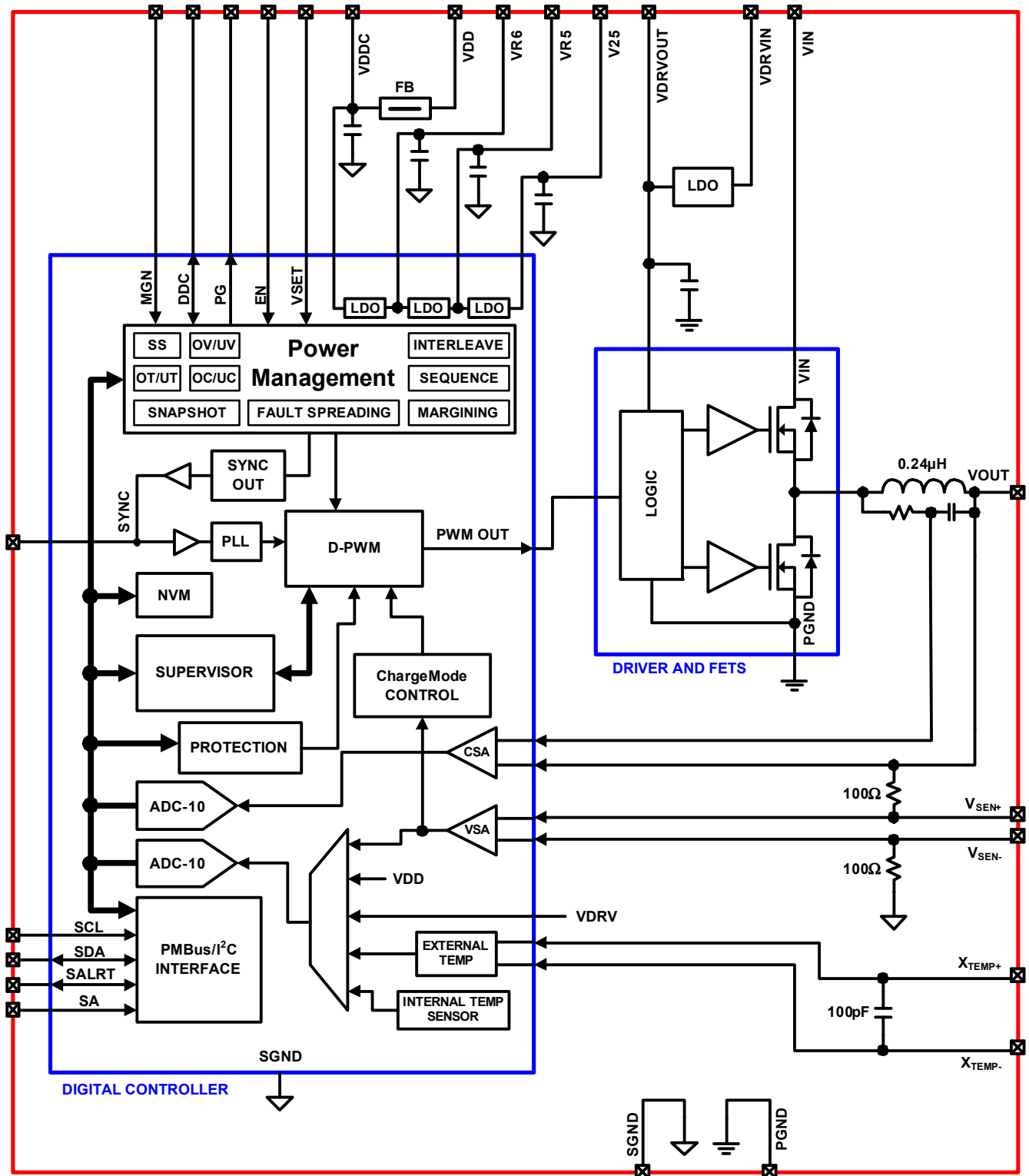

FIGURE 3. ISL8271M Internal Block Diagram

## Absolute Maximum Ratings

Input Supply Voltage, V <sub>IN</sub> Pin	-0.3V to 17V
Input Supply Voltage for Controller, V <sub>DD</sub> Pin	-0.3V to 17V
Input Gate Driver Supply Voltage, V <sub>DRVIN</sub> Pin	-0.3V to 17V
Output Gate Driver Supply Voltage, V <sub>DRVOUT</sub> Pin	-0.3V to 6V
6V Internal Reference Supply Voltage, V <sub>R6</sub> Pin	-0.3V to 6.6V
5V Internal Reference Supply Voltage, V <sub>R5</sub> Pin	-0.3V to 6.5V
2.5V Internal Reference Supply Voltage, V <sub>25</sub> Pin	-0.3V to 3V
Logic I/O Voltage for DDC, EN, MGN, PG, DISB#	
SA, SCL, SDA, SALRT, SYNC, UVLO, V <sub>MON</sub> , V <sub>SET</sub>	-0.3V to 6.0V
Analog Input Voltages for	
V <sub>SEN+</sub> , X <sub>TEMP+</sub>	-0.3V to 6.0V
V <sub>SEN-</sub> , X <sub>TEMP-</sub>	-0.3V to 0.3V
ESD Rating	
Human Body Model (Tested per JESD22-A114F)	2000V
Machine Model (Tested per JESD22-A115C)	200V
Charged Device Model (Tested per JESD22-C110D)	750V
Latch-Up (Tested per JESD78C; Class 2, Level A)	100mA

**CAUTION:** Do not operate at or near the maximum ratings listed for extended periods of time. Exposure to such conditions may adversely impact product reliability and result in failures not covered by warranty.

### NOTES:

- $\theta_{JA}$  is measured in free air with the module mounted on an evaluation board 3x4.5inch in size with 2oz surface and 2oz buried planes and multiple via interconnects as specified on [AN1925](#), "ISL8271MEVAL1Z Evaluation Board User Guide".
- For  $\theta_{JC}$ , the "case temp" location is the center of the package underside.

## Thermal Information

Thermal Resistance (Typical)	$\theta_{JA}$ (°C/W)	$\theta_{JC}$ (°C/W)
40 LD HDA Package ( <a href="#">Notes 6, 7</a> )	7.5	2.2
Maximum Junction Temperature (Plastic Package)	+125°C	
Storage Temperature Range	-55°C to +150°C	
Pb-free Reflow Profile	Refer to <a href="#">Figure 32</a>	

## Recommended Operating Conditions

Input Supply Voltage Range, V <sub>IN</sub>	4.5V to 14V
Input Supply Voltage Range for Controller, V <sub>DD</sub>	4.5V to 14V
Output Voltage Range, V <sub>OUT</sub>	0.6V to 5V
Output Current Range, I <sub>OUT(DC)</sub> ( <a href="#">Note 10</a> )	0A to 33A
Operating Junction Temperature Range, T <sub>J</sub>	-40°C to +125°C

**Electrical Specifications** V<sub>IN</sub> = V<sub>DD</sub> = 12V, f<sub>SW</sub> = 533kHz, C<sub>OUT</sub> = 1340µF, T<sub>A</sub> = -40°C to +85°C, unless otherwise noted. Typical values are at T<sub>A</sub> = +25°C. **Boldface limits apply across the operating temperature range, -40°C to +85°C.**

PARAMETER	SYMBOL	TEST CONDITIONS	MIN ( <a href="#">Note 8</a> )	TYP	MAX ( <a href="#">Note 8</a> )	UNITS
<b>INPUT AND SUPPLY CHARACTERISTICS</b>						
Input Supply Current for Controller	I <sub>DD</sub>	V <sub>IN</sub> = V <sub>DD</sub> = 12V, V <sub>OUT</sub> = 0V, module not enabled		40	<b>50</b>	mA
6V Internal Reference Supply Voltage	V <sub>R6</sub>		<b>5.5</b>	6.1	<b>6.6</b>	V
5V Internal Reference Supply Voltage	V <sub>R5</sub>	I <sub>VR5</sub> < 5mA	<b>4.5</b>	5.2	<b>5.5</b>	V
2.5V Internal Reference Supply Voltage	V <sub>25</sub>		<b>2.25</b>	2.5	<b>2.75</b>	V
Input Supply Voltage for Controller Read Back Resolution	V <sub>DD_READ_RES</sub>			10		Bits
Input Supply Voltage for Controller Read Back Total Error ( <a href="#">Note 11</a> )	V <sub>DD_READ_ERR</sub>	PMBus read		±2		%FS
<b>OUTPUT CHARACTERISTICS</b>						
Output Voltage Adjustment Range	V <sub>OUT_RANGE</sub>	V <sub>IN</sub> > V <sub>OUT</sub> + 1.8V	<b>0.54</b>		<b>5.5</b>	V
Output Voltage Set-Point Range	V <sub>OUT_RES</sub>	Configured using PMBus		±0.025		%
Output Voltage Set-Point Accuracy ( <a href="#">Notes 9, 11</a> )	V <sub>OUT_ACCY</sub>	Includes line, load and temperature (-20°C ≤ T <sub>A</sub> ≤ +85°C)	<b>-1</b>		<b>+1</b>	%V <sub>OUT</sub>
Output Voltage Read Back Resolution	V <sub>OUT_READ_RES</sub>			10		Bits
Output Voltage Read Back Total Error ( <a href="#">Note 11</a> )	V <sub>OUT_READ_ERR</sub>	PMBus read	<b>-2</b>		<b>+2</b>	%V <sub>OUT</sub>
Output Current Read Back Resolution	I <sub>OUT_READ_RES</sub>			10		Bits
Output Current Range ( <a href="#">Note 10</a> )	I <sub>OUT_RANGE</sub>				<b>33</b>	A
Output Current Read Back Total Error	I <sub>OUT_READ_ERR</sub>	PMBus read at maximum load		±2		A

**Electrical Specifications**  $V_{IN} = V_{DD} = 12V$ ,  $f_{SW} = 533kHz$ ,  $C_{OUT} = 1340\mu F$ ,  $T_A = -40^\circ C$  to  $+85^\circ C$ , unless otherwise noted. Typical values are at  $T_A = +25^\circ C$ . **Boldface limits apply across the operating temperature range,  $-40^\circ C$  to  $+85^\circ C$ .** (Continued)

PARAMETER	SYMBOL	TEST CONDITIONS	MIN (Note 8)	TYP	MAX (Note 8)	UNITS
<b>SOFT-START AND SEQUENCING</b>						
Delay Time from Enable to $V_{OUT}$ Rise	$t_{ON\_DELAY}$	Configured using PMBus	<b>2</b>		<b>5000</b>	ms
$t_{ON\_DELAY}$ Accuracy	$t_{ON\_DELAY\_ACCY}$			$\pm 2$		ms
Output Voltage Ramp-up Time	$t_{ON\_RISE}$	Configured using PMBus	<b>0.5</b>		<b>100</b>	ms
Output Voltage Ramp-up Time Accuracy	$t_{ON\_RISE\_ACCY}$			$\pm 250$		$\mu s$
Delay Time from disable to $V_{OUT}$ Fall	$t_{OFF\_DELAY}$	Configured using PMBus	<b>2</b>		<b>5000</b>	ms
$t_{OFF\_DELAY}$ Accuracy	$t_{OFF\_DELAY\_ACCY}$			$\pm 2$		ms
Output Voltage Fall Time	$t_{OFF\_FALL}$	Configured using PMBus	<b>0.5</b>		<b>100</b>	ms
Output Voltage Fall Time Accuracy	$t_{ON\_FALL\_ACCY}$			$\pm 250$		$\mu s$
<b>POWER-GOOD</b>						
Power-Good Delay	$V_{PG\_DELAY}$	Configured using PMBus	<b>0</b>		<b>5000</b>	ms
<b>TEMPERATURE SENSE</b>						
Temperature Sense Range	$T_{SENSE\_RANGE}$	Configurable using PMBus	<b>-50</b>		<b>150</b>	$^\circ C$
Internal Temperature Sensor Accuracy	$INT\_TEMP\_ACCY$	Tested at $+100^\circ C$	<b>-5</b>		<b>+5</b>	$^\circ C$
External Temperature Sensor Accuracy	$XTEMP\_ACCY$	Using 2N3904 NPN transistor		$\pm 5$		$^\circ C$
<b>FAULT PROTECTION</b>						
$V_{DD}$ Undervoltage Threshold Range	$V_{DD\_UVLO\_RANGE}$	Measured internally	<b>4.18</b>		<b>16</b>	V
$V_{DD}$ Undervoltage Threshold Accuracy (Note 11)	$V_{DD\_UVLO\_ACCY}$			$\pm 2$		%FS
$V_{DD}$ Undervoltage Response Time	$V_{DD\_UVLO\_DELAY}$			10		$\mu s$
$V_{OUT}$ Overvoltage Threshold Range	$V_{OUT\_OV\_RANGE}$	Factory default		$V_{OUT}+15$		%
		Configured using PMBus	<b><math>V_{OUT} + 5</math></b>		<b><math>V_{OUT\_MAX}</math></b>	%
$V_{OUT}$ Undervoltage Threshold Range	$V_{OUT\_UV\_RANGE}$	Factory default		$V_{OUT}-15$		%
		Configured using PMBus	<b>0</b>		<b><math>V_{OUT} - 5</math></b>	%
$V_{OUT}$ OV/UV Threshold Accuracy (Note 9)	$V_{OUT\_OV/UV\_ACCY}$		<b>-2</b>		<b>+2</b>	%
$V_{OUT}$ OV/UV Response Time	$V_{OUT\_OV/UV\_DELAY}$			10		$\mu s$
Output Current Limit Set-Point Accuracy (Note 11)	$I_{LIMIT\_ACCY}$	Tested at $I_{OUT\_OC\_FAULT\_LIMIT} = 40A$		$\pm 10$		%FS
Output Current Fault Response Time (Note 12)	$I_{LIMIT\_DELAY}$	Factory default		3		t <sub>sw</sub>
Over-Temperature Protection Threshold (Controller Junction Temperature)	$T_{JUNCTION}$	Factory default		125		$^\circ C$
		Configured using PMBus	<b>-40</b>		<b>125</b>	$^\circ C$
Thermal Protection Hysteresis	$T_{JUNCTION\_HYS}$			15		$^\circ C$
<b>OSCILLATOR AND SWITCHING CHARACTERISTICS</b>						
Switching Frequency Range	$f_{SW\_RANGE}$		<b>296</b>		<b>1067</b>	kHz
Switching Frequency Set-Point Accuracy	$f_{SW\_ACCY}$		<b>-5</b>		<b>+5</b>	%
Minimum Pulse Width Required from External SYNC Clock	$EXT\_SYNC_{PW}$	Measured at 50% amplitude	<b>150</b>			ns



**Electrical Specifications**  $V_{IN} = V_{DD} = 12V$ ,  $f_{SW} = 533kHz$ ,  $C_{OUT} = 1340\mu F$ ,  $T_A = -40^\circ C$  to  $+85^\circ C$ , unless otherwise noted. Typical values are at  $T_A = +25^\circ C$ . **Boldface limits apply across the operating temperature range,  $-40^\circ C$  to  $+85^\circ C$ .** (Continued)

PARAMETER	SYMBOL	TEST CONDITIONS	MIN (Note 8)	TYP	MAX (Note 8)	UNITS
Drift Tolerance for External SYNC Clock	EXT_SYNC <sub>DRIFT</sub>	External SYNC clock equal to 500kHz is not supported	<b>-10</b>		<b>+10</b>	%
<b>LOGIC INPUT/OUTPUT CHARACTERISTICS</b>						
Bias Current at the Logic Input Pins	$I_{LOGIC\_BIAS}$	DDC, EN, MGN, PG, SA, SCL, SDA, SALRT, SYNC, UVLO, $V_{MON}$ , $V_{SET}$	<b>-100</b>		<b>+100</b>	nA
Logic Input Low Threshold Voltage	$V_{LOGIC\_IN\_LOW}$				<b>0.8</b>	V
Logic Input High Threshold Voltage	$V_{LOGIC\_IN\_HIGH}$		<b>2.0</b>			V
Logic Output Low Threshold Voltage	$V_{LOGIC\_OUT\_LOW}$	2mA sinking			<b>0.5</b>	V
Logic Output High Threshold Voltage	$V_{LOGIC\_OUT\_HIGH}$	2mA sourcing	<b>2.25</b>			V
<b>PMBus INTERFACE TIMING CHARACTERISTIC</b>						
PMBus Operating Frequency	$F_{SMB}$		<b>100</b>		<b>400</b>	kHz

**NOTES:**

8. Compliance to datasheet limits is assured by one or more methods: Production test, characterization, and/or design.
9.  $V_{OUT}$  measured at the termination of the  $V_{SEN+}$  and  $V_{SEN-}$  sense points.
10. The MAX load current is determined by the thermal ["Derating Curves" on page 12](#), provided with this document.
11. "FS" stand for full scale of recommended maximum operation range.
12. " $t_{SW}$ " stands for time period of operation switching frequency.

# Typical Performance Curves

**Efficiency Performance** Operating condition:  $T_A = +25^\circ\text{C}$ , no air flow.  $C_{OUT} = 1340\mu\text{F}$ . Typical values are used unless otherwise noted.

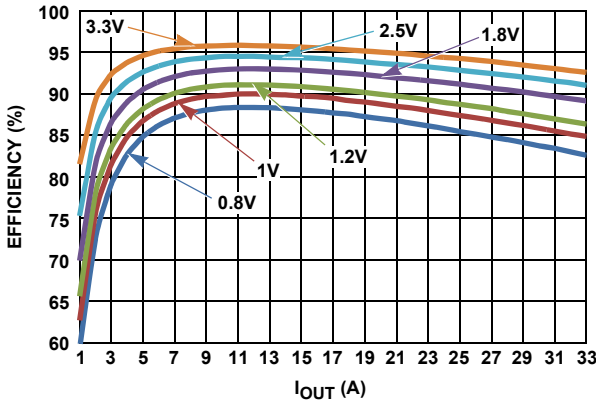

FIGURE 4. EFFICIENCY vs OUTPUT CURRENT AT  $V_{IN} = 5\text{V}$  AND  $f_{SW} = 533\text{kHz}$  FOR VARIOUS OUTPUT VOLTAGES

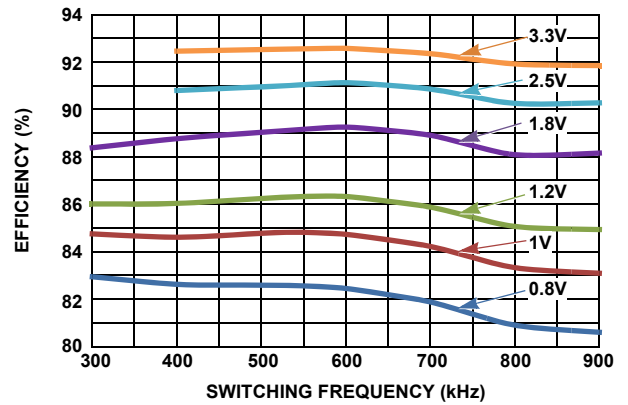

FIGURE 5. EFFICIENCY vs SWITCHING FREQUENCY AT  $V_{IN} = 5\text{V}$  AND  $I_{OUT} = 33\text{A}$  FOR VARIOUS OUTPUT VOLTAGES

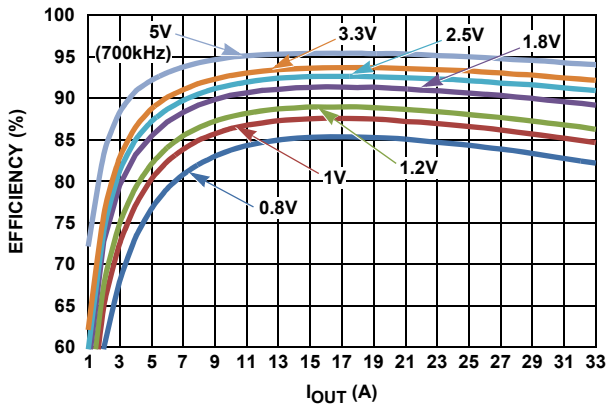

FIGURE 6. EFFICIENCY vs OUTPUT CURRENT AT  $V_{IN} = 9\text{V}$  AND  $f_{SW} = 533\text{kHz}$  FOR VARIOUS OUTPUT VOLTAGES

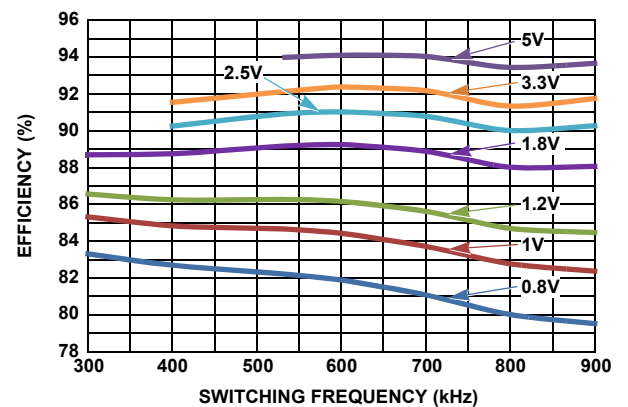

FIGURE 7. EFFICIENCY vs SWITCHING FREQUENCY AT  $V_{IN} = 9\text{V}$  AND  $I_{OUT} = 33\text{A}$  FOR VARIOUS OUTPUT VOLTAGES

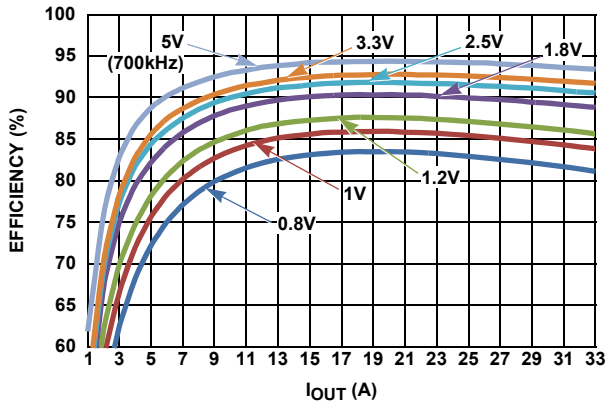

FIGURE 8. EFFICIENCY vs OUTPUT CURRENT AT  $V_{IN} = 12\text{V}$  AND  $f_{SW} = 533\text{kHz}$  FOR VARIOUS OUTPUT VOLTAGES

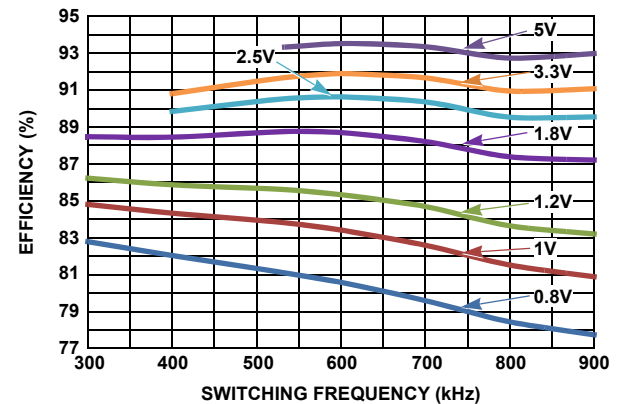

FIGURE 9. EFFICIENCY vs SWITCHING FREQUENCY AT  $V_{IN} = 12\text{V}$  AND  $I_{OUT} = 33\text{A}$  FOR VARIOUS OUTPUT VOLTAGES

## Typical Performance Curves (Continued)

**Transient Response Performance**  $C_{OUT} = 4 \times 100\mu\text{F}$  ceramic and  $2 \times 470\mu\text{F}$  POSCAP,  $I_{OUT} = 0/16\text{A}$ ,  $T_A = +25^\circ\text{C}$ . Typical values are used unless otherwise noted.

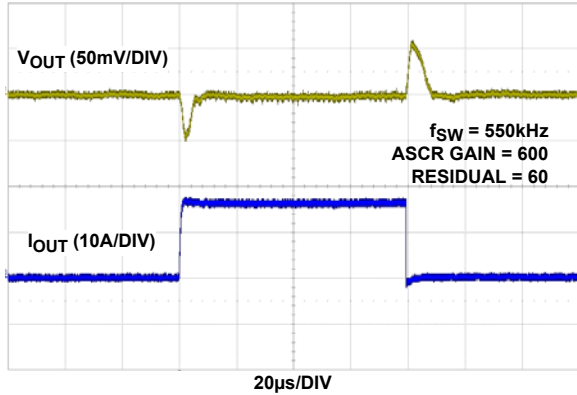

FIGURE 10. LOAD TRANSIENT RESPONSE AT  $V_{IN} = 12\text{V}$ ,  $V_{OUT} = 1\text{V}$  WITH HIGH BANDWIDTH ASCR PARAMETER

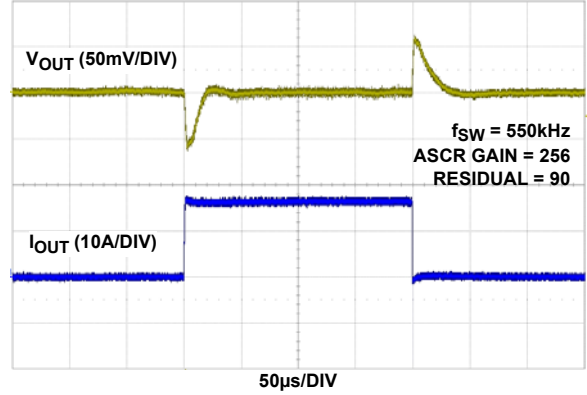

FIGURE 11. LOAD TRANSIENT RESPONSE AT  $V_{IN} = 12\text{V}$ ,  $V_{OUT} = 1\text{V}$  WITH DEFAULT ASCR PARAMETERS

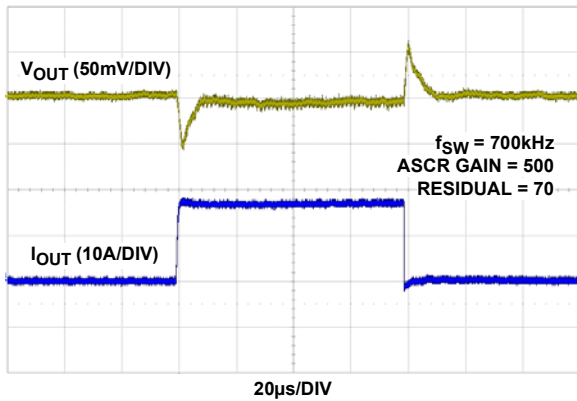

FIGURE 12. LOAD TRANSIENT RESPONSE AT  $V_{IN} = 12\text{V}$ ,  $V_{OUT} = 2.5\text{V}$  WITH HIGH BANDWIDTH ASCR PARAMETERS

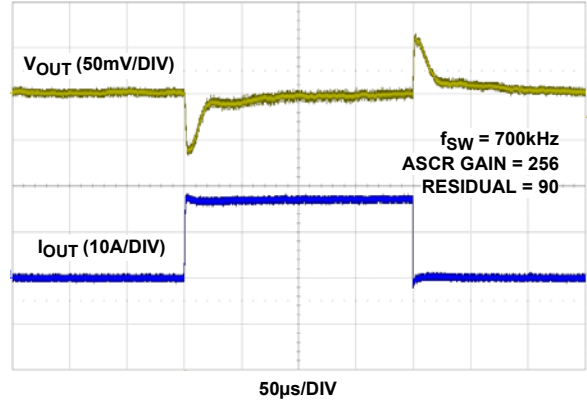

FIGURE 13. LOAD TRANSIENT RESPONSE AT  $V_{IN} = 12\text{V}$ ,  $V_{OUT} = 2.5\text{V}$  WITH DEFAULT ASCR PARAMETERS

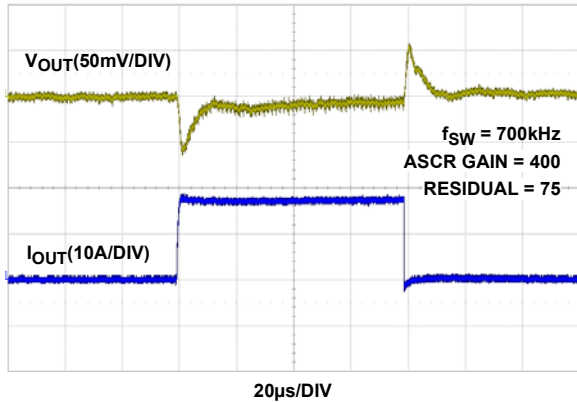

FIGURE 14. LOAD TRANSIENT RESPONSE AT  $V_{IN} = 12\text{V}$ ,  $V_{OUT} = 3.3\text{V}$  WITH HIGH BANDWIDTH ASCR PARAMETERS

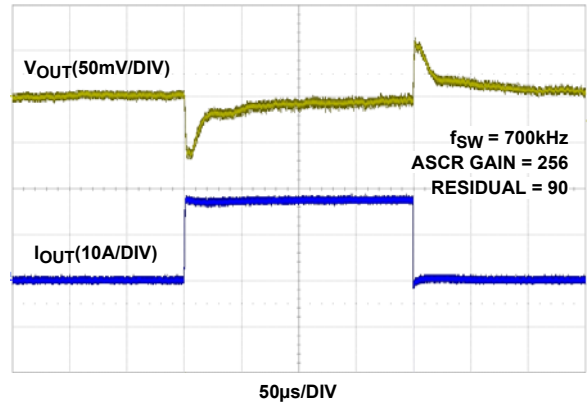

FIGURE 15. LOAD TRANSIENT RESPONSE AT  $V_{IN} = 12\text{V}$ ,  $V_{OUT} = 3.3\text{V}$  WITH DEFAULT ASCR PARAMETERS

## Typical Performance Curves (Continued)

**Derating Curves** All of the following curves were plotted at  $T_J = +115^\circ\text{C}$ ,  $f_{SW} = 533\text{kHz}$ .

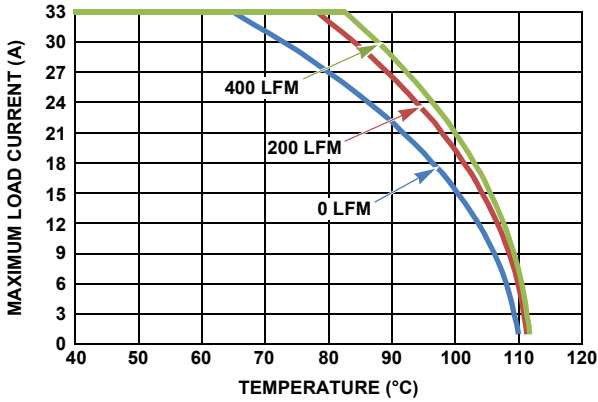

FIGURE 16. 5V<sub>IN</sub> TO 1V<sub>OUT</sub>

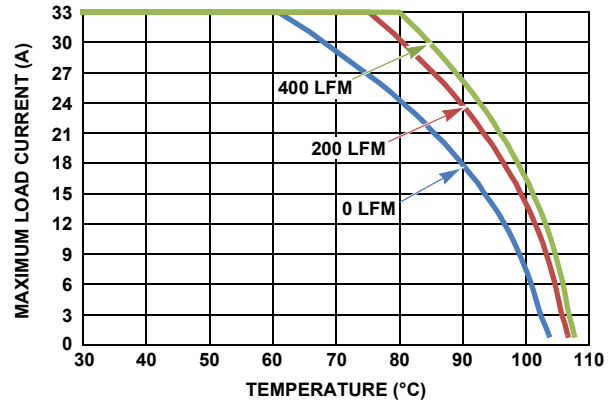

FIGURE 17. 12V<sub>IN</sub> TO 1V<sub>OUT</sub>

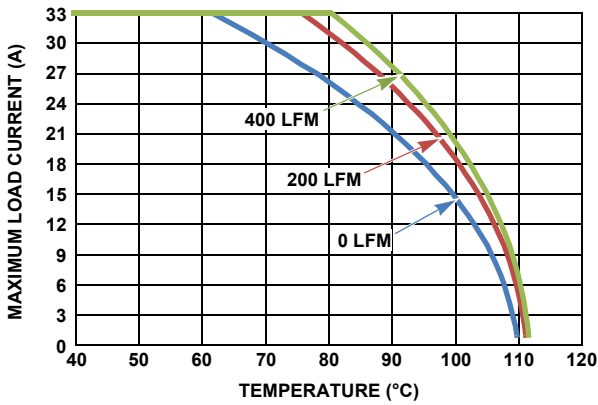

FIGURE 18. 5V<sub>IN</sub> TO 1.2V<sub>OUT</sub>

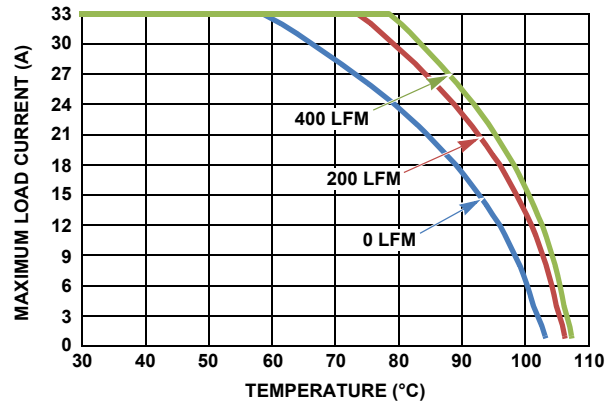

FIGURE 19. 12V<sub>IN</sub> TO 1.2V<sub>OUT</sub>

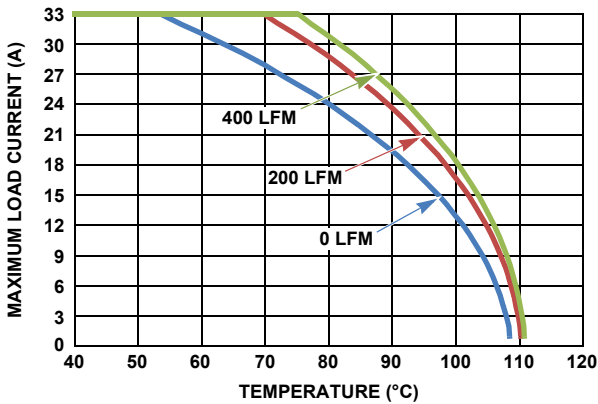

FIGURE 20. 5V<sub>IN</sub> TO 1.8V<sub>OUT</sub>

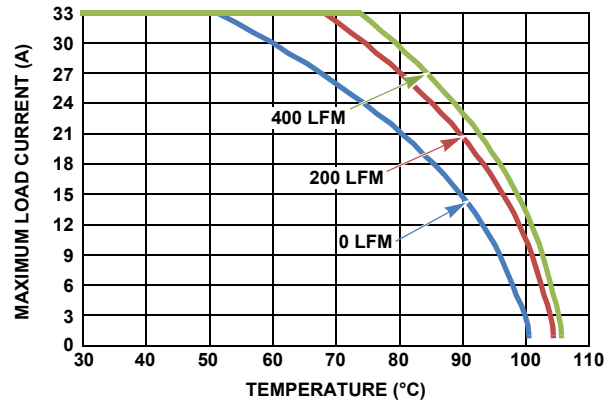

FIGURE 21. 12V<sub>IN</sub> TO 1.8V<sub>OUT</sub>

## Typical Performance Curves (Continued)

**Derating Curves** All of the following curves were plotted at  $T_J = +115^\circ\text{C}$ ,  $f_{\text{SW}} = 533\text{kHz}$  (Continued)

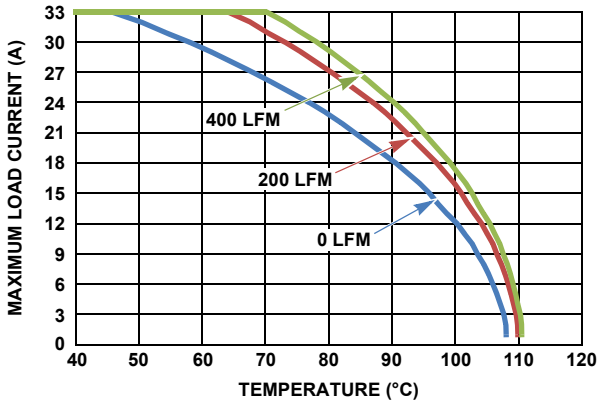

FIGURE 22.  $5V_{\text{IN}}$  TO  $2.5V_{\text{OUT}}$

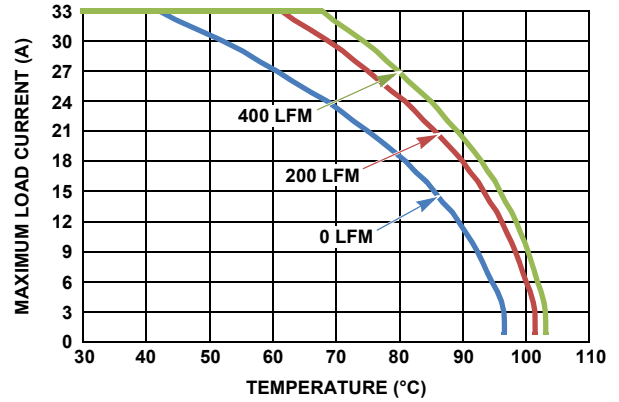

FIGURE 23.  $12V_{\text{IN}}$  TO  $2.5V_{\text{OUT}}$

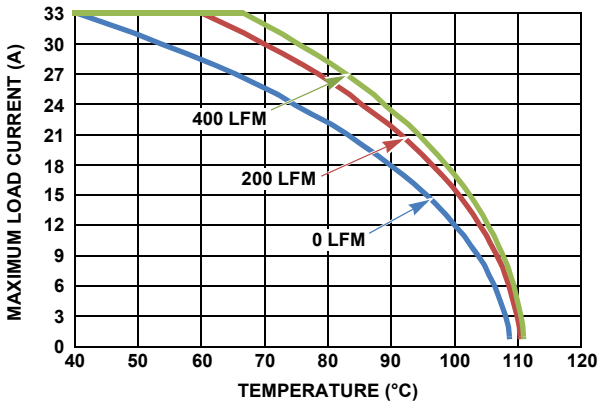

FIGURE 24.  $5V_{\text{IN}}$  TO  $3.3V_{\text{OUT}}$

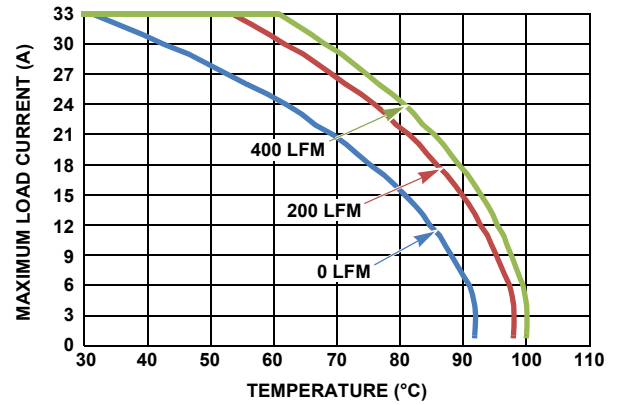

FIGURE 25.  $12V_{\text{IN}}$  TO  $3.3V_{\text{OUT}}$

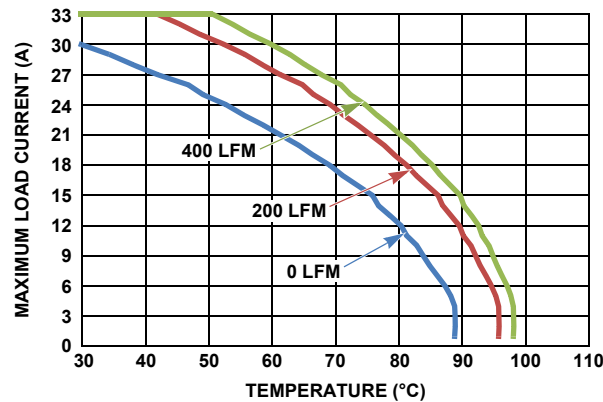
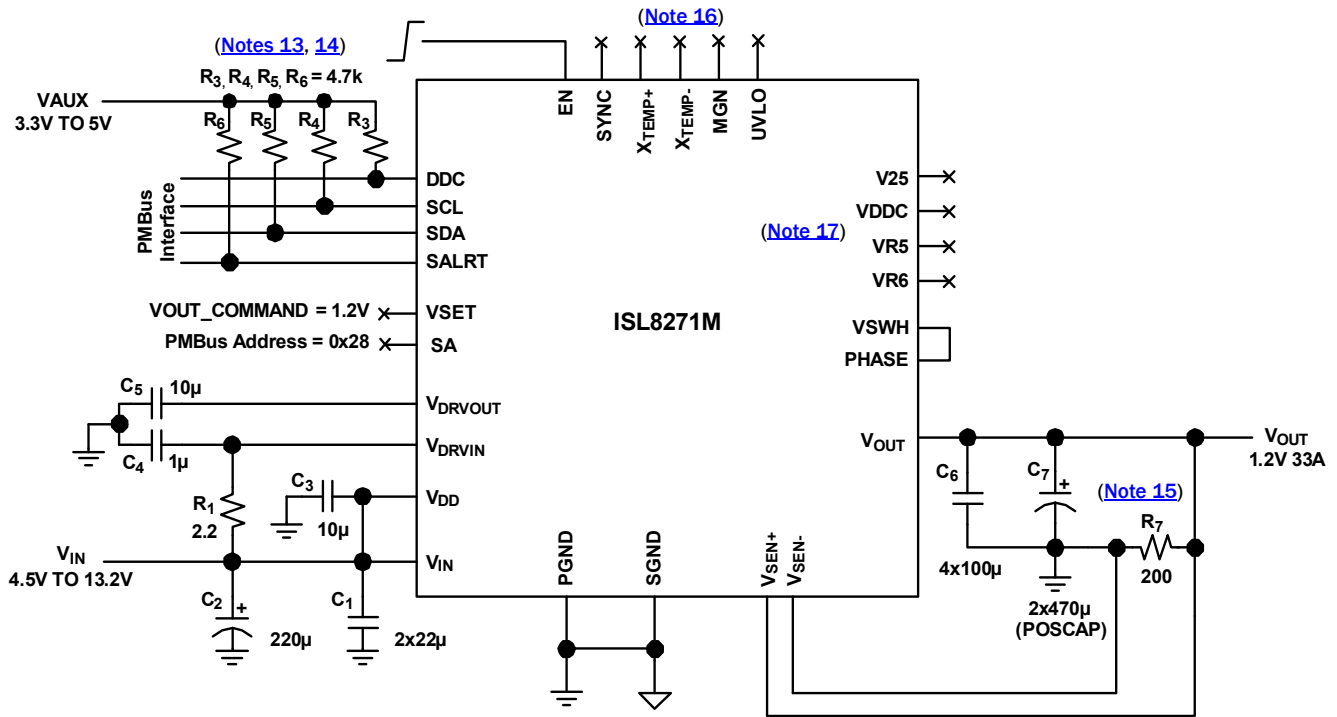

FIGURE 26.  $12V_{\text{IN}}$  TO  $5V_{\text{OUT}}$ , 700kHz

# Typical Application Circuit



**NOTES:**

- 13. R4 and R5 are not required if the PMBus host already has I<sup>2</sup>C pull-up resistors.
- 14. Only one R3 per DDC bus is required when DDC bus is shared with other modules.
- 15. R7 is optional but recommended to sink possible ~100μA back-flow current from the V<sub>SEN+</sub> pin. Back-flow current is present only when the module is in a disabled state with power still available at the VDD pin.
- 16. Unused pins (SYNC, XTEMP, MGN, UVLO) can be no connect.
- 17. Internal reference supply pins (V25, VDDC, VR5, VR6) do not need external capacitors and can be no connect. Refer to [“PCB Layout Guidelines” on page 21](#) for more information.

**FIGURE 27. TYPICAL SINGLE-PHASE APPLICATION CIRCUIT FOR 1.2V/33A OUTPUT**

TABLE 1. ISL8271M DESIGN GUIDE MATRIX AND OUTPUT VOLTAGE RESPONSE

V <sub>IN</sub> (V)	V <sub>OUT</sub> (V)	C <sub>IN</sub> (BULK) (Note 18)	C <sub>IN</sub> (CERAMIC)	C <sub>OUT</sub> (BULK)	C <sub>OUT</sub> (CERAMIC)	ASCR GAIN (Note 19)	ASCR RESIDUAL (Note 19)	P-P DEVIATION (mV)	RECOVERY TIME (μs)	LOAD STEP (Note 20) (A)	FREQ. (kHz)
5	1	2x150μF	4x47μF	2x470μF	6x100μF	350	90	50	20	16.5	516
12	1	2x150μF	3x22μF	4x470μF	4x100μF	200	80	45	20	16.5	348
12	1	2x150μF	2x22μF	2x470μF	6x100μF	350	90	50	22	16.5	516
5	1.8	2x150μF	5x47μF	2x470μF	3x100μF	220	90	80	16	16.5	516
12	1.8	2x150μF	3x22μF	2x470μF	3x100μF	190	80	80	14	16.5	516
5	2.5	2x150μF	5x47μF	1x470μF	3x100μF	140	90	120	25	16.5	516
12	2.5	2x150μF	2x22μF	1x470μF	3x100μF	220	100	110	16	16.5	696
5	3.3	2x150μF	4x47μF	1x470μF	3x100μF	120	80	130	25	16.5	516
12	3.3	2x150μF	3x22μF	1x470μF	3x100μF	220	100	130	25	16.5	696
12	5	2x150μF	3x22μF	1x470μF	1x100μF	200	70	180	6	16.5	1066

## NOTES:

18. C<sub>IN</sub> bulk capacitor is optional only for energy buffer from the long input power supply cable.
19. ASCR gain and residual are selected to guarantee that the phase margin is higher than 60° and gain margin is higher than 6dB at room temperature and full load (33A).
20. Output voltage response is tested with load step slew rate higher than 20A/μs.

TABLE 2. RECOMMENDED I/O CAPACITOR IN TABLE 1

VENDORS	VALUE	PART NUMBER
Murata, Input Ceramic	47μF, 16V, 1210	GRM32ER61C476ME15L
Murata, Input Ceramic	22μF, 16V, 1210	GRM32ER61E226KE15L
Taiyo Yuden, Input Ceramic	47μF, 16V, 1210	EMK325BJ476MM-T
Taiyo Yuden, Input Ceramic	22μF, 25V, 1210	TMK325BJ226MM-T
Murata, Output Ceramic	100μF, 6.3V, 1210	GRM32ER60J107M
TDK, Output Ceramic	100μF, 6.3V, 1210	C3225X5R0J107M
AVX, Output Ceramic	100μF, 6.3V, 1210	12106D107MAT2A
Sanyo POSCAP, Input Bulk	150μF, 16V	16TQC150MYF
Sanyo POSCAP, Output Bulk	470μF, 4V	4TPE470MCL
Sanyo POSCAP, Output Bulk	470μF, 6.3V	6TPF470MAH

## Functional Description

### SMBus Communications

The ISL8271M provides an SMBus digital interface that enables the user to configure all aspects of the module operation as well as monitor the input and output parameters. The ISL8271M can be used with any SMBus host device. In addition, the module is compatible with PMBus Power System Management Protocol Specification Parts I & II version 1.2. The ISL8271M accepts most standard PMBus commands. When controlling the device with PMBus commands, it is recommended that the enable pin be tied to SGND.

The SMBus device address is the only parameter that must be set by external pins. All other device parameters can be set with PMBus commands.

The ISL8271M can operate without PMBus in pin-strap mode with configurations programmed by pin-strap resistors, such as output voltage, switching frequency, device SMBus address, input UVLO, soft-start/stop, and current sharing. Note that pin-strap resistors with 1% tolerance or better should be used for all the pin-strap settings.

### Output Voltage Selection

The output voltage can be set to a voltage between 0.6V and 5V provided that the input voltage is higher than the desired output voltage by an amount sufficient to maintain regulation.

The VSET pin is used to set the output voltage to levels as shown in [Table 3](#). The R<sub>SET</sub> resistor is placed between the VSET pin and SGND. A standard 1% resistor is recommend.

TABLE 3. OUTPUT VOLTAGE RESISTOR SETTINGS

V <sub>OUT</sub> (V)	R <sub>SET</sub> (kΩ)
0.60	10
0.65	11
0.70	12.1
0.75	13.3
0.80	14.7
0.85	16.2
0.90	17.8
0.95	19.6
1.00	21.5 or connect to SGND
1.05	23.7
1.10	26.1
1.15	28.7
1.20	31.6 or Open
1.25	34.8
1.30	38.3
1.40	42.2
1.50	46.4
1.60	51.1

TABLE 3. OUTPUT VOLTAGE RESISTOR SETTINGS (Continued)

V <sub>OUT</sub> (V)	R <sub>SET</sub> (kΩ)
1.70	56.2
1.80	61.9
1.90	68.1
2.00	75
2.10	82.5
2.20	90.9
2.30	100
2.50	110 or connect to V25
2.80	121
3.00	133
3.30	147
4.00	162
5.00	178

The output voltage can also be set to any value between 0.6V and 5V using the PMBus command VOUT\_COMMAND. By default, VOUT\_MAX is set 110% higher than V<sub>OUT</sub> set by the pin-strap resistor, which can be changed to any value up to 5.5V with the PMBus command VOUT\_MAX.

### Soft-Start Delay and Ramp Times

It may be necessary to set a delay from when an enable signal is received until the output voltage starts to ramp to its target value. In addition, the designer may want to precisely set the time required for V<sub>OUT</sub> to ramp to its target value after the delay period has expired. These features can be used as part of an overall inrush current management strategy or to precisely control how fast a load IC is turned on. The ISL8271M gives the system designer several options for precisely and independently controlling both the delay and ramp time periods. The soft-start delay period begins when the EN pin is asserted and ends when the delay time expires.

The soft-start delay and ramp times can be programmed to custom values with the PMBus commands TON\_DELAY and TON\_RISE. When the delay time is set to 0ms, the device begins its ramp-up after the internal circuitry has initialized (approximately 2ms). When the soft-start ramp period is set to 0ms, the output ramps up as quickly as the output load capacitance and loop settings allow. It is generally recommended to set the soft-start ramp to a value greater than 500μs to prevent inadvertent fault conditions due to excessive inrush current.



## Power-Good

The ISL8271M provides a Power-Good (PG) signal that indicates the output voltage is within a specified tolerance of its target level and no fault condition exists. By default, the PG pin asserts if the output is within 10% of the target voltage. These limits and the polarity of the pin can be changed with PMBus command POWER\_GOOD\_ON.

A PG delay period is defined as the time from when all conditions within the ISL8271M for asserting PG are met to when the PG pin is actually asserted. This feature is commonly used instead of an external reset controller to control external digital logic. A PG delay can be programmed with the PMBus command POWER\_GOOD\_DELAY.

## Switching Frequency and PLL

The device's switching frequency is set from 296kHz to 1067kHz using the pin-strap method as shown in [Table 1](#), or by using a PMBus command FREQUENCY\_SWITCH. The ISL8271M incorporates an internal Phase-Locked Loop (PLL) to clock the internal circuitry. The PLL can be driven by an external clock source connected to the SYNC pin. When using the internal oscillator, the SYNC pin can be configured as a clock source as an external sync to other modules. Refer to SYNC\_CONFIG command on [page 46](#) for more information. A standard 1% resistor is required if using pin-strap.

TABLE 4. SWITCHING FREQUENCY RESISTOR SETTINGS

f <sub>sw</sub> (kHz)	R <sub>SET</sub> (kΩ)
296	14.7 or connect to SGND
320	16.2
364	17.8
400	19.6
421	21.5
471	23.7
533	26.1 or Open
571	28.7
615	31.6
727	34.8
800	38.3
842	42.2
889	46.4
1067	51.1 or connect to V25

## Loop Compensation

The module is internally compensated using the PMBus command ASCR\_CONFIG. The ISL8271M uses the ChargeMode control algorithm that responds to output current changes within a single PWM switching cycle, achieving a smaller total output voltage variation with less output capacitance than traditional PWM controllers.

## Input Undervoltage Lockout (UVLO)

The input Undervoltage Lockout (UVLO) prevents the ISL8271M from operating when the input falls below a preset threshold, indicating the input supply is out of its specified range. The UVLO threshold (V<sub>UVLO</sub>) can be set between 4.18V and 16V using the pin-strap method as shown in [Table 2](#), or by using the PMBus command VIN\_UV\_FAULT\_LIMIT. A standard 1% resistor is required if using pin-strap.

Fault response to an input undervoltage fault can be programmed with the PMBus command VIN\_UV\_FAULT\_RESPONSE.

TABLE 5. UVLO RESISTOR SETTINGS

UVLO (V)	R <sub>UVLO</sub> (kΩ)
4.5	Open
10.8	Connect to V25
4.18	26.1
4.59	28.7
5.06	31.6
5.57	34.8
6.13	38.3
6.75	42.2
7.42	46.4
8.18	51.1
8.99	56.2
9.90	61.9
10.90	68.1
12.00	75
13.20	82.5
14.54	90.9
16.00	100

## SMBus Module Address Selection

Each module must have its own unique serial address to distinguish between other devices on the bus. The module address is set by connecting a resistor between the SA pin and SGND. Table 6 lists the available module addresses. A standard 1% resistor is required.

TABLE 6. SMBus ADDRESS RESISTOR SELECTION

R <sub>SA</sub> (kΩ)	SMBus ADDRESS
10	19h
11	1Ah
12.1	1Bh
13.3	1Ch
14.7	1Dh
16.2	1Eh
17.8	1Fh
19.6	20h
21.5	21h
23.7	22h
26.1	23h
28.7	24h
31.6	25h
34.8 or connect to SGND	26h
38.3	27h
42.2 or Open	28h
46.4	29h
51.1	2Ah
56.2	2Bh
61.9	2Ch
68.1	2Dh
75	2Eh
82.5	2Fh
90.9	30h
100	31h

## Output Overvoltage Protection

The ISL8271M offers an internal output overvoltage protection circuit that can be used to protect sensitive load circuitry from being subjected to a voltage higher than its prescribed limits. A hardware comparator is used to compare the actual output voltage (seen at the V<sub>SEN+</sub>, V<sub>SEN-</sub> pins) to a threshold 15% higher than the target output voltage (the default setting). The fault threshold can be programmed to a desired level with the PMBus command VOUT\_OV\_FAULT\_LIMIT. If the V<sub>SEN+</sub> voltage exceeds this threshold, the module will initiate an immediate shutdown without retrying. Retry settings can be programmed with the PMBus command VOUT\_OV\_FAULT\_RESPONSE.

Internal to the module, two 100Ω resistors are populated from VOUT to V<sub>SEN+</sub> and SGND to V<sub>SEN-</sub> to protect from overvoltage conditions in case of open VSENSE pins and differential remote sense traces due to assembly error. As long as the differential

remote sense traces have low resistance, V<sub>OUT</sub> regulation accuracy is not sacrificed.

## Output Prebias Protection

An output prebias condition exists when an externally applied voltage is present on a power supply's output before the power supply's control IC is enabled. Certain applications require that the converter not be allowed to sink current during start-up if a prebias condition exists at the output. The ISL8271M provides prebias protection by sampling the output voltage before initiating an output ramp.

If a prebias voltage lower than the target voltage exists after the preconfigured delay period has expired, the target voltage is set to match the existing prebias voltage and both drivers are enabled. The output voltage is then ramped to the final regulation value at the preconfigured ramp rate.

The actual time the output takes to ramp from the prebias voltage to the target voltage varies, depending on the prebias voltage, however, the total time elapsed from when the delay period expires and when the output reaches its target value will match the preconfigured ramp time (see Figure 28).

If a prebias voltage is higher than the target voltage after the preconfigured delay period has expired, the target voltage is set to match the existing prebias voltage and both drivers are enabled with a PWM duty cycle that would ideally create the prebias voltage.

When the preconfigured soft-start ramp period has expired, the PG pin is asserted (assuming the prebias voltage is not higher than the overvoltage limit). The PWM then adjusts its duty cycle to match the original target voltage and the output ramps down to the preconfigured output voltage.

If a prebias voltage is higher than the overvoltage limit, the device does not initiate a turn-on sequence and declares an overvoltage fault condition. The device then responds based on the output overvoltage fault response setting programmed with the PMBus command VOUT\_OV\_FAULT\_RESPONSE.

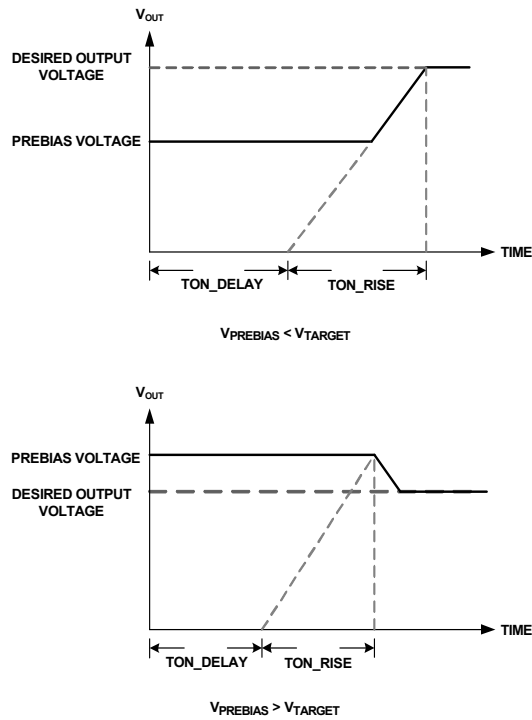

FIGURE 28. OUTPUT RESPONSES TO PREBIAS VOLTAGES

## Output Overcurrent Protection

The ISL8271M can protect the power supply from damage if the output is shorted to ground or if an overload condition is imposed on the output. The average output overcurrent fault threshold can be programmed with the PMBus command `IOUT_OC_FAULT_LIMIT`. The module automatically programs the peak inductor current fault threshold by calculating the inductor ripple current by reading the real-time input voltage, switching frequency, and the `VOUT_COMMAND`. When the peak inductor current crosses the peak inductor current fault threshold for five successive cycle, the module will initiate an immediate shutdown.

The default response from an overcurrent fault is an immediate shutdown without retrying. Retry settings can be programmed with the PMBus command `MFR_IOUT_OC_FAULT_RESPONSE`.

## Thermal Overload Protection

The ISL8271M includes a thermal sensor that continuously measures the internal temperature of the module and shuts down the controller when the temperature exceeds the preset limit. The default temperature limit is set to  $+125^{\circ}\text{C}$  in the factory, but can be changed with the PMBus command `OT_FAULT_LIMIT`.

The default response from an over-temperature fault is an immediate shutdown without retrying. Retry settings can be programmed with the PMBus command `OT_FAULT_RESPONSE`.

If the user has configured the module to retry, the controller waits the preset delay period (if configured to do so) and then checks the module temperature. If the temperature has dropped below a threshold that is approximately  $+15^{\circ}\text{C}$  lower than the selected temperature fault limit, the controller attempts to

restart. If the temperature still exceeds the fault limit, the controller waits the preset delay period and retries again.

## Digital-DC Bus

The Digital-DC Communications (DDC) bus is used to communicate between Intersil digital power modules and digital controllers. This dedicated bus provides the communication channel between devices for features such as sequencing and fault spreading. The DDC pin on all Digital-DC devices in an application should be connected together. A pull-up resistor is required on the DDC bus to guarantee the rise time as shown in [Equation 1](#):

$$\text{Rise Time} = R_{PU} * C_{LOAD} \approx 1 \mu\text{s} \quad (\text{EQ. 1})$$

where  $R_{PU}$  is the DDC bus pull-up resistance and  $C_{LOAD}$  is the bus loading.

The pull-up resistor can be tied to an external 3.3V or 5V supply as long as this voltage is present before or during device power-up. In principle, each device connected to the DDC bus presents approximately 10pF of capacitive loading and each inch of FR4 PCB trace introduces approximately 2pF. The ideal design uses a central pull-up resistor that is well matched to the total load capacitance.

## Phase Spreading

When multiple point-of-load converters share a common DC input supply, it is recommended to adjust the clock phase offset of each device, so that not all devices start to switch simultaneously. Setting each converter to start its switching cycle at a different time can dramatically reduce input capacitance requirements and efficiency losses. Because the peak current drawn from the input supply is effectively spread out over a period of time, the peak current drawn at any given moment is reduced and the power losses proportional to the  $I_{RMS}^2$  are reduced dramatically.

To enable phase spreading, all converters must be synchronized to the same switching clock. The phase offset of each device can also be set to any value between  $0^{\circ}$  and  $360^{\circ}$  in  $22.5^{\circ}$  increments with the PMBus command `INTERLEAVE`.

## Output Sequencing

A group of Digital-DC modules or devices can be configured to power up in a predetermined sequence. This feature is especially useful when powering advanced processors (FPGAs and ASICs that require one supply to reach its operating voltage) before another supply reaching its operating voltage to avoid latch-up. Multi-device sequencing can be achieved by configuring each device with PMBus command `SEQUENCE`. Multiple device sequencing is configured by issuing PMBus commands to assign the preceding device in the sequencing chain as well as the device that follows in the sequencing chain.

The Enable pins of all devices in a sequencing group must be tied together and driven high to initiate a sequenced turn-on of the group. Enable must be driven low to initiate a sequenced turnoff of the group.

## Fault Spreading

Digital DC modules and devices can be configured to broadcast a fault event over the DDC bus to the other devices in the group with the PMBus command DDC\_GROUP. When a non-destructive fault occurs and the device is configured to shut down on a fault, the device shuts down and broadcasts the fault event over the DDC bus. The other devices on the DDC bus shut down simultaneously (if configured to do so) and attempt to restart in their prescribed order.

## Temperature Monitoring Using XTEMP Pin

The ISL8271M supports measurement of an external device temperature using either a thermal diode integrated in a processor, FPGA or ASIC, or using a discrete diode-connected 2N3904 NPN transistor. [Figure 29](#) illustrates the typical connections required. The external temperature sensors can be used to provide the temperature reading for over-temperature and under-temperature faults. These options for the external temperature sensors are enabled using the USER\_CONFIG PMBus command.

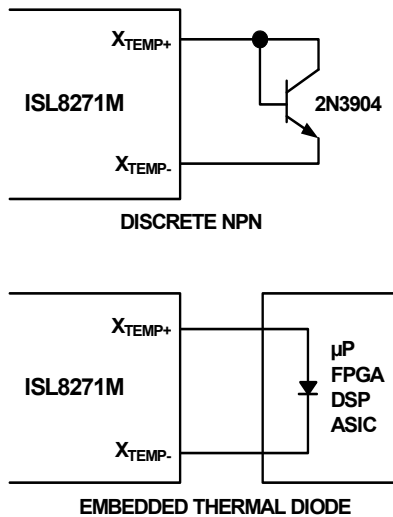

FIGURE 29. EXTERNAL TEMPERATURE MONITORING

## Monitoring Using SMBus

A system controller can monitor a wide variety of ISL8271M system parameters using PMBus commands:

- READ\_VIN
- READ\_VOUT
- READ\_IOUT
- READ\_TEMPERATURE\_1
- READ\_TEMPERATURE\_2
- READ\_DUTY\_CYCLE
- READ\_FREQUENCY
- MFR\_READ\_VMON

## Snapshot Parameter Capture

The ISL8271M offers a feature to capture parametric data and some fault status after a fault. A detailed description is provided in [“SNAPSHOT \(EAh\)” on page 47](#) and [“SNAPSHOT\\_CONTROL \(F3h\)” on page 47](#).

## Nonvolatile Memory

The ISL8271M has internal nonvolatile memory that stores user configurations. Integrated security measures ensure that the user can restore the module only to a level that has been made available to them. During the initialization process, the ISL8271M checks for stored values contained in its internal non-volatile memory.

Modules are shipped with factory defaults configuration and most settings can be overwritten with PMBus commands and can be stored in nonvolatile memory with the PMBus command STORE\_USER\_ALL.



## Thermal Considerations

Experimental power loss curves, along with  $\theta_{JA}$  from thermal modeling analysis, can be used to evaluate the thermal consideration for the module. The derating curves are derived from the maximum power allowed while maintaining the temperature below the maximum junction temperature of +125°C. For an actual application, other heat sources and design margin should be considered.

## Package Description

The structure of the ISL8271M belongs to the High Density Array (HDA) no-lead package. This kind of package has advantages, such as good thermal and electrical conductivity, low weight, and small size. The HDA package is applicable for surface mounting technology and is being more readily used in the industry. The ISL8271M contains several types of devices, including resistors, capacitors, inductors, and control ICs. The ISL8271M is a copper lead-frame based package with exposed copper thermal pads, which have good electrical and thermal conductivity. The copper lead frame and multi component assembly is over-molded with polymer mold compound to protect the devices.

The package outline, a typical PCB land pattern design, and a typical stencil opening edge position are shown on pages 51, 56, and 57 respectively. The module has a small size of 17mmx19mmx3.55mm. Figure 32 shows typical reflow profile parameters. These guidelines are general design rules. Users can modify parameters according to their application.

## PCB Layout Pattern Design

The bottom of the ISL8271M is a lead-frame footprint, which is attached to the PCB by a surface mounting process. The PCB layout pattern is shown on page 54. The PCB layout pattern is an array of solder-mask-defined PCB lands that align with the perimeters of the HDA exposed pads and I/O termination dimensions. The thermal lands on the PCB layout also feature an array of solder-mask-defined lands and should match 1:1 with the package exposed die pad perimeters. The exposed solder-mask-defined PCB land area should be 50-80% of the available module I/O area.

## Thermal Vias

A grid of 1.0mm to 1.2mm pitch thermal vias, that drops down and connects to buried copper plane(s) should be placed under the thermal land. The vias should be about 0.3mm to 0.33mm in diameter with the barrel plated to about 1.0 ounce copper. Although adding more vias (by decreasing via pitch) will improve the thermal performance, diminishing returns will be seen as more and more vias are added. Simply use as many vias as practical for the thermal land size and your board design rules allow.

## Stencil Pattern Design

Reflowed solder joints on the perimeter I/O lands should have about a 50µm to 75µm (2mil to 3mil) standoff height. The solder paste stencil design is the first step in developing optimized, reliable solder joints.

The stencil aperture size to solder-mask-defined PCB land size ratio should typically be 1:1. The aperture width can be reduced slightly to help prevent solder bridging between adjacent I/O lands. A typical solder stencil pattern is shown in the "Package Outline Drawing" section starting on page 51. The user should consider the symmetry of the whole stencil pattern when designing its pads. A laser cut, stainless steel stencil with electropolished trapezoidal walls is recommended. Electropolishing "smooths" the aperture walls resulting in reduced surface friction and better paste release, which reduces voids. Using a Trapezoidal Section Aperture (TSA) also promotes paste release and forms a "brick like" paste deposit that assists in firm component placement. A 0.1mm to 0.15mm stencil thickness is recommended for this large pitch (1.3mm) HDA.

## Reflow Parameters

Due to the low mount height of the HDA, "No Clean" Type 3 solder paste per ANSI/J-STD-005 is recommended. Nitrogen purge is also recommended during reflow. A system board reflow profile depends on the thermal mass of the entire populated board, thus it is not practical to define a specific soldering profile just for the HDA. The profile given in Figure 32 is provided as a guideline, to be customized for varying manufacturing practices and applications.

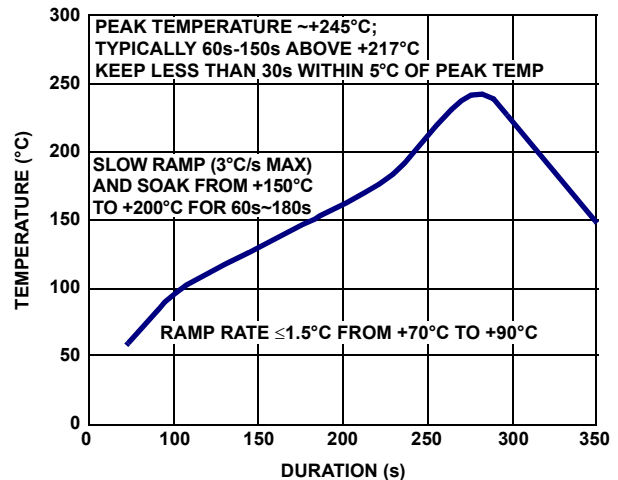

FIGURE 32. TYPICAL REFLOW PROFILE



## PMBus Command Summary

COMMAND CODE	COMMAND NAME	DESCRIPTION	TYPE	DATA FORMAT	DEFAULT VALUE	DEFAULT SETTING	PAGE
01h	OPERATION	Sets Enable, Disable, and $V_{OUT}$ Margin modes.	R/W BYTE	BIT			<a href="#">27</a>
02h	ON_OFF_CONFIG	Configures the EN pin and PMBus commands to turn the unit ON/OFF	R/W BYTE	BIT	17h	Hardware Enable, Immediate Off	<a href="#">27</a>
03h	CLEAR_FAULTS	Clears fault indications.	SEND BYTE				<a href="#">28</a>
15h	STORE_USER_ALL	Stores all PMBus values written since last restore at user level.	SEND BYTE				<a href="#">28</a>
16h	RESTORE_USER_ALL	Restores PMBus settings that were stored using STORE_USER_ALL.	SEND BYTE				<a href="#">28</a>
20h	VOUT_MODE	Preset to defined data format of $V_{OUT}$ commands.	READ BYTE	BIT	13h	Linear Mode, Exponent = -13	<a href="#">28</a>
21h	VOUT_COMMAND	Sets the nominal value of the output voltage.	R/W WORD	L16u		Pin-Strap	<a href="#">28</a>
23h	VOUT_CAL_OFFSET	Applies a fixed offset voltage to the VOUT_COMMAND.	R/W WORD	L16s	0000h	0V	<a href="#">29</a>
24h	VOUT_MAX	Sets the maximum possible value of $V_{OUT}$ . 110% of pin-strap $V_{OUT}$ .	R/W WORD	L16u		$1.1 * V_{OUT}$ Pin-Strap	<a href="#">29</a>
25h	VOUT_MARGIN_HIGH	Sets the value of the $V_{OUT}$ during a margin high.	R/W WORD	L16u		$1.05 * V_{OUT}$ Pin-Strap	<a href="#">29</a>
26h	VOUT_MARGIN_LOW	Sets the value of the $V_{OUT}$ during a margin low.	R/W WORD	L16u		$0.95 * V_{OUT}$ Pin-Strap	<a href="#">29</a>
27h	VOUT_TRANSITION_RATE	Sets the transition rate during margin or other change of $V_{OUT}$ .	R/W WORD	L11	BA00h	1V/ms	<a href="#">29</a>
28h	VOUT_DROOP	Sets the loadline (V/I Slope) resistance for the rail.	R/W WORD	L11	0000h	0mV/A	<a href="#">30</a>
33h	FREQUENCY_SWITCH	Sets the switching frequency.	R/W WORD	L11		Pin-Strap	<a href="#">30</a>
37h	INTERLEAVE	Configures a phase offset between devices sharing a SYNC clock.	R/W WORD	BIT	0000h	Set based on PMBus Address	<a href="#">30</a>
38h	IOUT_CAL_GAIN	Sense resistance for inductor DCR current sensing.	R/W WORD	L11	B2AEh	0.67m $\Omega$	<a href="#">30</a>
39h	IOUT_CAL_OFFSET	Sets the current-sense offset.	R/W WORD	L11	0000h	0A	<a href="#">30</a>
40h	VOUT_OV_FAULT_LIMIT	Sets the $V_{OUT}$ overvoltage fault threshold.	R/W WORD	L16u		$1.15 * V_{OUT}$ Pin-Strap	<a href="#">31</a>
41h	VOUT_OV_FAULT_RESPONSE	Configures the $V_{OUT}$ overvoltage fault response.	R/W BYTE	BIT	80h	Disable and No Retry	<a href="#">31</a>
42h	VOUT_OV_WARN_LIMIT	Sets the $V_{OUT}$ overvoltage warn threshold.	R/W WORD	L16u		$1.10 * V_{OUT}$ Pin-Strap	<a href="#">31</a>
43h	VOUT_UV_WARN_LIMIT	Sets the $V_{OUT}$ undervoltage warn threshold.	R/W WORD	L16u		$0.9 * V_{OUT}$ Pin-Strap	<a href="#">31</a>
44h	VOUT_UV_FAULT_LIMIT	Sets the $V_{OUT}$ undervoltage fault threshold.	R/W WORD	L16u		$0.85 * V_{OUT}$ Pin-Strap	<a href="#">31</a>
45h	VOUT_UV_FAULT_RESPONSE	Configures the $V_{OUT}$ undervoltage fault response.	R/W BYTE	BIT	80h	Disable and No Retry	<a href="#">32</a>
46h	IOUT_OC_FAULT_LIMIT	Sets the $I_{OUT}$ average overcurrent fault threshold.	R/W WORD	L11	E280h	40A	<a href="#">32</a>
4Bh	IOUT_UC_FAULT_LIMIT	Sets the $I_{OUT}$ average undercurrent fault threshold.	R/W WORD	L11	E57Fh	-40A	<a href="#">32</a>
4Fh	OT_FAULT_LIMIT	Sets the over-temperature fault threshold.	R/W WORD	L11	EBE8h	+125 °C	<a href="#">32</a>

## PMBus Command Summary (Continued)

COMMAND CODE	COMMAND NAME	DESCRIPTION	TYPE	DATA FORMAT	DEFAULT VALUE	DEFAULT SETTING	PAGE
50h	OT_FAULT_RESPONSE	Configures the over-temperature fault response.	R/W BYTE	BIT	80h	Disable and No Retry	<a href="#">33</a>
51h	OT_WARN_LIMIT	Sets the over-temperature warning limit.	R/W WORD	L11	Eb70h	+110 °C	<a href="#">33</a>
52h	UT_WARN_LIMIT	Sets the under-temperature warning limit.	R/W WORD	L11	DC40h	-30 °C	<a href="#">33</a>
53h	UT_FAULT_LIMIT	Sets the under-temperature fault threshold.	R/W WORD	L11	E530h	-45 °C	<a href="#">33</a>
54h	UT_FAULT_RESPONSE	Configures the under-temperature fault response.	R/W BYTE	BIT	80h	Disable and No Retry	<a href="#">34</a>
55h	VIN_OV_FAULT_LIMIT	Sets the $V_{IN}$ overvoltage fault threshold.	R/W WORD	L11	D3A0h	14.5V	<a href="#">34</a>
56h	VIN_OV_FAULT_RESPONSE	Configures the $V_{IN}$ overvoltage fault response.	R/W BYTE	BIT	80h	Disable and No Retry	<a href="#">34</a>
57h	VIN_OV_WARN_LIMIT	Sets the input overvoltage warning limit.	R/W WORD	L11	D34Dh	13.2V	<a href="#">35</a>
58h	VIN_UV_WARN_LIMIT	Sets the input undervoltage warning limit.	R/W WORD	L11		$1.10 * V_{IN}$ UV Fault Limit	<a href="#">35</a>
59h	VIN_UV_FAULT_LIMIT	Sets the $V_{IN}$ undervoltage fault threshold.	R/W WORD	L11		Pin-Strap	<a href="#">35</a>
5Ah	VIN_UV_FAULT_RESPONSE	Configures the $V_{IN}$ undervoltage fault response.	R/W BYTE	BIT	80h	Disable and No Retry	<a href="#">35</a>
5Eh	POWER_GOOD_ON	Sets the voltage threshold for Power-Good indication.	R/W WORD	L16u		$0.9 * V_{OUT}$ Pin-Strap	<a href="#">36</a>
60h	TON_DELAY	Sets the delay time from ENABLE to start of $V_{OUT}$ rise.	R/W WORD	L11	CA80h	5ms	<a href="#">36</a>
61h	TON_RISE	Sets the rise time of $V_{OUT}$ after ENABLE and TON_DELAY.	R/W WORD	L11	CA80h	5ms	<a href="#">36</a>
64h	TOFF_DELAY	Sets the delay time from DISABLE to start of $V_{OUT}$ fall.	R/W WORD	L11	CA80h	5ms	<a href="#">36</a>
65h	TOFF_FALL	Sets the fall time for $V_{OUT}$ after DISABLE and TOFF_DELAY.	R/W WORD	L11	CA80h	5ms	<a href="#">36</a>
78h	STATUS_BYTE	Returns an abbreviated status for fast reads.	READ BYTE	BIT	00h	No Faults	<a href="#">37</a>
79h	STATUS_WORD	Returns information with a summary of the units's fault condition.	READ WORD	BIT	0000h	No Faults	<a href="#">37</a>
7Ah	STATUS_VOUT	Returns the $V_{OUT}$ specific status.	READ BYTE	BIT	00h	No Faults	<a href="#">38</a>
7Bh	STATUS_IOUT	Returns the $I_{OUT}$ specific status.	READ BYTE	BIT	00h	No Faults	<a href="#">38</a>
7Ch	STATUS_INPUT	Returns specific status specific to the input.	READ BYTE	BIT	00h	No Faults	<a href="#">38</a>
7Dh	STATUS_TEMPERATURE	Returns the temperature specific status.	READ BYTE	BIT	00h	No Faults	<a href="#">39</a>
7Eh	STATUS_CML	Returns the Communication, Logic and Memory specific status.	READ BYTE	BIT	00h	No Faults	<a href="#">39</a>
80h	STATUS_MFR_SPECIFIC	Returns the VDRV and External Sync clock specific status.	READ BYTE	BIT	00h	No Faults	<a href="#">39</a>
88h	READ_VIN	Returns the input voltage reading.	READ WORD	L11			<a href="#">40</a>
8Bh	READ_VOUT	Returns the output voltage reading.	READ WORD	L16u			<a href="#">40</a>
8Ch	READ_IOUT	Returns the output current reading.	READ WORD	L11			<a href="#">40</a>



## PMBus Command Summary (Continued)

COMMAND CODE	COMMAND NAME	DESCRIPTION	TYPE	DATA FORMAT	DEFAULT VALUE	DEFAULT SETTING	PAGE
8Dh	READ_TEMPERATURE_1	Returns the temperature reading internal to the device.	READ WORD	L11			<a href="#">40</a>
8Eh	READ_TEMPERATURE_2	Returns the temperature reading from external monitor source.	READ WORD	L11			<a href="#">40</a>
94h	READ_DUTY_CYCLE	Returns the duty cycle reading during the ENABLE state.	READ WORD	L11			<a href="#">40</a>
95h	READ_FREQUENCY	Returns the measured operating switch frequency.	READ WORD	L11			<a href="#">40</a>
99h	MFR_ID	Sets a user defined identification.	R/W BLOCK	ASC		Manufacturing information	<a href="#">41</a>
9Ah	MFR_MODEL	Sets a user defined model.	R/W BLOCK	ASC		Null	<a href="#">41</a>
9Bh	MFR_REVISION	Sets a user defined revision.	R/W BLOCK	ASC		Null	<a href="#">41</a>
9Ch	MFR_LOCATION	Sets a user defined location identifier.	R/W BLOCK	ASC		Null	<a href="#">41</a>
9Dh	MFR_DATE	Sets a user defined date.	R/W BLOCK	ASC		Null	<a href="#">41</a>
9Eh	MFR_SERIAL	Sets a user defined serialized identifier.	R/W BLOCK	ASC		Null	<a href="#">42</a>
A8h	LEGACY_FAULT_GROUP	Broadcast faults when mixed with old generation modules	R/W BLOCK	BIT	00000000h		<a href="#">42</a>
B0h	USER_DATA_00	Sets a user defined data.	R/W BLOCK	ASC		Null	<a href="#">42</a>
D0h	ISENSE_CONFIG	Configures ISENSE related features.	R/W BYTE	BIT	05h	256ns Blanking Time, Mid Range	<a href="#">43</a>
D1h	USER_CONFIG	Configures several user-level features.	R/W BYTE	BIT	00h	Open Drain PG, XTEMP Disabled	<a href="#">43</a>
D3h	DDC_CONFIG	Configures the DDC bus.	R/W BYTE	BIT	00h	Set based on PMBus Address	<a href="#">43</a>
D4h	POWER_GOOD_DELAY	Sets the delay between $V_{OUT} > PG$ threshold and asserting the PG pin.	R/W WORD	L11	CA00h	4ms	<a href="#">44</a>
DFh	ASCCR_CONFIG	Configures ASCCR control loop.	R/W BLOCK	CUS	015A0100h	Residual = 90 Gain = 256	<a href="#">44</a>
E0h	SEQUENCE	Identifies the Rail DDC ID to perform multi-rail sequencing.	R/W WORD	BIT	0000h	Prequel and Sequel Disabled	<a href="#">44</a>
E2h	DDC_GROUP	Sets rail DDC IDs to obey faults and margining spreading information.	R/W BLOCK	BIT	000000h	Broadcast Disabled	<a href="#">45</a>
E4h	DEVICE_ID	Returns the 16-byte (character) device identifier string.	READ BLOCK	ASC		Reads Device Version	<a href="#">45</a>
E5h	MFR_IOUT_OC_FAULT_RESPONSE	Configures the $I_{OUT}$ overcurrent fault response.	R/W BYTE	BIT	80h	Disable and No Retry	<a href="#">45</a>
E6h	MFR_IOUT_UC_FAULT_RESPONSE	Configures the $I_{OUT}$ undercurrent fault response.	R/W BYTE	BIT	80h	Disable and No Retry	<a href="#">46</a>
E9h	SYNC_CONFIG	Configures the Sync pin.	R/W BYTE	BIT	00h	Pin-Strap	<a href="#">46</a>
EAh	SNAPSHOT	Returns 32-byte read-back of parametric and status values.	READ BLOCK	BIT			<a href="#">47</a>
EBh	BLANK_PARAMS	Returns recently changed parameter values.	READ BLOCK	BIT	FF...FFh		<a href="#">47</a>
F3h	SNAPSHOT_CONTROL	Snapshot feature control command.	R/W BYTE	BIT			<a href="#">47</a>
F4h	RESTORE_FACTORY	Restores device to the factory default values.	SEND BYTE				<a href="#">48</a>

## PMBus Command Summary (Continued)

COMMAND CODE	COMMAND NAME	DESCRIPTION	TYPE	DATA FORMAT	DEFAULT VALUE	DEFAULT SETTING	PAGE
F5h	MFR_VMON_OV_FAULT_LIMIT	Returns the VDRV overvoltage threshold.	READ WORD	L11	CB00h	6V	<a href="#">48</a>
F6h	MFR_VMON_UV_FAULT_LIMIT	Returns the VDRV undervoltage threshold.	READ WORD	L11	CA00h	4V	<a href="#">48</a>
F7h	MFR_READ_VMON	Returns the VDRV voltage reading.	READ WORD	L11			<a href="#">48</a>
F8h	VMON_OV_FAULT_RESPONSE	Returns the VDRV overvoltage response.	READ BYTE	BIT	80h	Disable and No Retry	<a href="#">48</a>
F9h	VMON_UV_FAULT_RESPONSE	Returns the VDRV undervoltage response.	READ BYTE	BIT	80h	Disable and No Retry	<a href="#">48</a>

## PMBus Data Formats

### Linear-11 (L11)

The L11 data format uses 5-bit two's complement exponent (N) and 11-bit two's complement mantissa (Y) to represent a real world decimal value (X).

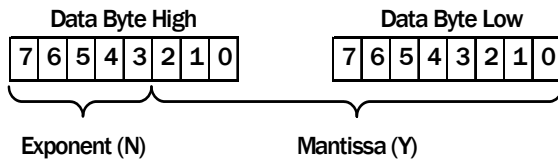

The relation between real world decimal value (X), N, and Y is:  $X = Y \cdot 2^N$

### Linear-16 Unsigned (L16u)

The L16u data format uses a fixed exponent (hard-coded to N = -13h) and a 16-bit unsigned integer mantissa (Y) to represent real world decimal value (X). Relation between real world decimal value (X), N and Y is:  $X = Y \cdot 2^{-13}$

### Linear-16 Signed (L16s)

The L16s data format uses a fixed exponent (hard-coded to N = -13h) and a 16-bit two's complement mantissa (Y) to represent real world decimal value (X).

The relation between real world decimal value (X), N, and Y is:  $X = Y \cdot 2^{-13}$

### Bit Field (BIT)

A breakdown of the Bit Field format is provided in PMBus on [“PMBus Command Description” on page 27](#).

### Custom (CUS)

A breakdown of the Custom data format is provided in PMBus [“PMBus Command Description” on page 27](#). A combination of Bit Field and integer are common type of Custom data format.

### ASCII (ASC)

A variable length string of text characters uses ASCII data format.

## PMBus Use Guidelines

PMBus is a powerful tool that allows users to optimize circuit performance by configuring devices for their applications. When configuring a device in a circuit, the device should be disabled whenever most settings are changed with PMBus commands. Some exceptions to this recommendation are OPERATION, ON\_OFF\_CONFIG, CLEAR\_FAULTS, VOUT\_COMMAND, VOUT\_MARGIN\_HIGH, VOUT\_MARGIN\_LOW, and ASCCR\_CONFIG. While the device is enabled any command can be read. Many commands do not take effect until after the device has been re-enabled, hence the recommendation that commands that change device settings are written while the device is disabled.

When sending the STORE\_USER\_ALL and RESTORE\_USER\_ALL commands, it is recommended that no other commands are sent to the device for 100ms after sending the STORE or RESTORE commands.

In addition, there should be a 2ms delay between repeated READ commands sent to the same device. When sending any other command, a 5ms delay is recommended between repeated commands sent to the same device. Commands not listed in the PMBus command summary are not allowed for customer use, and are reserved for factory use only. Issuing reserved commands may result in unexpected operation.

### Summary

All commands can be read at any time.

Always disable the device when writing commands that change device settings. Exceptions to this rule are commands intended to be written while the device is enabled, for example, VOUT\_MARGIN\_HIGH.

To be sure a change to a device setting has taken effect, write the STORE\_USER\_ALL command, then cycle input power and re-enable.

## PMBus Command Description

### OPERATION (01h)

**Definition:** Sets Enable, Disable, and  $V_{OUT}$  Margin settings. Data values of OPERATION that force margin high or low only take effect when the MGN pin is left open, for example, in the NOMINAL margin state.

**Data Length in Bytes:** 1

**Data Format:** BIT

**Type:** R/W

**Default Value:**

**Units:** N/A

SETTINGS	ACTIONS
04h	Immediate off (no sequencing).
44h	Soft off (with sequencing).
84h	On - Nominal.
94h	On - Margin low.
A4h	On - Margin high.

### ON\_OFF\_CONFIG (02h)

**Definition:** Configures the interpretation and coordination of the OPERATION command and the ENABLE pin (EN).

**Data Length in Bytes:** 1

**Data Format:** BIT

**Type:** R/W

**Default Value:** 17h (Device starts from ENABLE pin with immediate off)

**Units:** N/A

SETTINGS	ACTIONS
00h	Device starts any time power is present regardless of ENABLE pin or OPERATION command states.
16h	Device starts from ENABLE pin with soft off.
17h	Device starts from ENABLE pin with immediate off.
1Ah	Device starts from OPERATION command.

**CLEAR\_FAULTS (03h)**

**Definition:** Clears all fault bits in all registers and releases the SALRT pin (if asserted) simultaneously. If a fault condition still exists, the bit will reassert immediately. This command will not restart a device if it has shut down, it will only clear the faults.

**Data Length in Bytes:** 0 Byte

**Data Format:** N/A

**Type:** Send byte

**Default Value:** N/A

**Units:** N/vA

**Reference:** N/A

**STORE\_USER\_ALL (15h)**

**Definition:** Stores all PMBus settings from the operating memory to the nonvolatile USER store memory. To clear the USER store, perform a RESTORE\_FACTORY then STORE\_USER\_ALL. To add to the USER store, perform a RESTORE\_USER\_ALL, write commands to be added, then STORE\_USER\_ALL. This command can be used during device operation, but the device will be unresponsive for 20ms while storing values.

**Data Length in Bytes:** 0

**Data Format:** N/A

**Type:** Send byte

**Default Value:** N/A

**Units:** N/A

**RESTORE\_USER\_ALL (16h)**

**Definition:** Restores all PMBus settings from the USER store memory to the operating memory. Command performed at power-up. Security level is changed to Level 1 following this command. This command can be used during device operation, but the device will be unresponsive for 20ms while storing values.

**Data Length in Bytes:** 0

**Data Format:** N/A

**Type:** Send byte

**Default Value:** N/A

**Units:** N/A

**VOUT\_MODE (20h)**

**Definition:** Reports the  $V_{OUT}$  mode and provides the exponent used in calculating several  $V_{OUT}$  settings. Fixed with linear mode with default exponent (N) = -13.

**Data Length in Bytes:** 1

**Data Format:** BIT

**Type:** Read only

**Default Value:** 13h (Linear Mode, N = -13)

**Units:** N/A

**VOUT\_COMMAND (21h)**

**Definition:** Sets or reports the target output voltage. This command cannot set a value higher than either  $V_{OUT\_MAX}$  or 110% of the pin-strap  $V_{OUT}$  setting.

**Data Length in Bytes:** 2

**Data Format:** L16u

**Type:** R/W

**Default Value:** Pin-strap setting

**Units:** Volts

**Range:** 0V to  $V_{OUT\_MAX}$

---

### **VOUT\_CAL\_OFFSET (23h)**

**Definition:** Applies a fixed offset voltage to the output voltage command value. This command is typically used by the user to calibrate a device in the application circuit.

**Data Length in Bytes:** 2

**Data Format:** L16s

**Type:** R/W

**Default Value:** 0000h

**Units:** Volts

### **VOUT\_MAX (24h)**

**Definition:** Sets an upper limit on the output voltage the unit can command regardless of any other commands or combinations. The intent of this command is to provide a safeguard against a user accidentally setting the output voltage to a possibly destructive level rather than to be the primary output overprotection. Default value can be changed using PMBus.

**Data Length in Bytes:** 2

**Data Format:** L16u

**Type:** R/W

**Default Value:** 1.10 x VOUT\_COMMAND pin-strap setting

**Units:** Volts

**Range:** 0V to 5.5V

### **VOUT\_MARGIN\_HIGH (25h)**

**Definition:** Sets the value of the  $V_{OUT}$  during a margin high. This VOUT\_MARGIN\_HIGH command loads the unit with the voltage to which the output is to be changed when the OPERATION command is set to "Margin High".

**Data Length in Bytes:** 2

**Data Format:** L16u

**Type:** R/W word

**Default value:** 1.05 x VOUT\_COMMAND pin-strap setting

**Units:** V

**Range:** 0V to VOUT\_MAX

### **VOUT\_MARGIN\_LOW (26h)**

**Definition:** Sets the value of the  $V_{OUT}$  during a margin low. This VOUT\_MARGIN\_LOW command loads the unit with the voltage to which the output is to be changed when the OPERATION command is set to "Margin Low".

**Data Length in Bytes:** 2

**Data Format:** L16u

**Type:** R/W

**Default value:** 0.95 x VOUT\_COMMAND pin-strap setting

**Units:** V

**Range:** 0V to VOUT\_MAX

### **VOUT\_TRANSITION\_RATE (27h)**

**Definition:** Sets the rate at which the output should change voltage when the device receives an OPERATION command (Margin High, Margin Low) that causes the output voltage to change. The maximum possible positive value of the two data bytes indicates that the device should make the transition as quickly as possible.

**Data Length in Bytes:** 2

**Data Format:** L11

**Type:** R/W

**Default value:** BA00h (1.0 V/ms)

**Units:** V/ms

**Range:** 0.1 to 4V/ms

**VOUT\_DROOP (28h)**

**Definition:** Sets the effective load line (V/I slope) for the rail in which the device is used. It is the rate, in mV/A at which the output voltage decreases (or increases) with increasing (or decreasing) output current for use with Adaptive Voltage Positioning schemes.

**Data Length in Bytes:** 2

**Data Format:** L11

**Type:** R/W

**Default value:** 0000h (0mV/A)

**Units:** mV/A

**Range:** 0 to 40 mV/A

**FREQUENCY\_SWITCH (33h)**

**Definition:** Sets the switching frequency of the device. Initial default value is defined by a pin-strap and this value can be overridden by writing this command using PMBus. If an external SYNC is used, this value should be set as close as possible to the external clock value. The output must be disabled when writing this command.

**Data Length in Bytes:** 2

**Data Format:** L11

**Type:** R/W

**Default Value:** Pin-strap setting

**Units:** kHz

**Range:** 300kHz to 1066MHz

**INTERLEAVE (37h)**

**Definition:** Configures the phase offset of a device that is sharing a common SYNC clock with other devices. A value of 0 for the Number in Group field is interpreted as 16, to allow for phase spreading groups of up to 16 devices.

**Data Length in Bytes:** 2

**Data Format:** BIT

**Type:** R/W

**Default Value:** Pin-strap setting

**Units:** kHz

BITS	PURPOSE	VALUE	DESCRIPTION
15:2	Reserved	0	Reserved
11:8	Group Number	0 to 15	Sets a number to a group of interleaved rails
7:4	Number in Group	0 to 15	Sets the number of rails in the group A value of 0 is interpreted as 16
3:0	Position in Group	0 to 15	Sets position of the device's rail within the group

**IOUT\_CAL\_GAIN (38h)**

**Definition:** Sets the effective impedance across the current sense circuit for use in calculating output current at +25°C.

**Data Length in Bytes:** 2

**Data Format:** L11.

**Type:** R/W

**Default Value:** B2AEh (0.67mΩ)

**Units:** mΩ

**IOUT\_CAL\_OFFSET (39h)**

**Definition:** Used to null out any offsets in the output current sensing circuit and to compensate for delayed measurements of current ramp due to I<sub>SENSE</sub> blanking time.

**Data Length in Bytes:** 2

**Data Format:** 11.

**Type:** R/W

**Default Value:** 0000h (0A)

**Units:** A

**VOUT\_OV\_FAULT\_LIMIT (40h)**

**Definition:** Sets the  $V_{OUT}$  overvoltage fault threshold.

**Data Length in Bytes:** 2

**Data Format:** L16u

**Type:** R/W

**Default Value:** 1.15 x VOUT\_COMMAND pin-strap setting

**Units:** V

**Range:** 0V to VOUT\_MAX

**VOUT\_OV\_FAULT\_RESPONSE (41h)**

**Definition:** Configures the  $V_{OUT}$  overvoltage fault response. Note that the device cannot be set to ignore this fault mode.

**Data Length in Bytes:** 1

**Data Format:** BIT

**Type:** R/W

**Default Value:** 80h (Disable and no retry)

**Units:**

BIT	FIELD NAME	VALUE	DESCRIPTION
7:6	Reserved	10	
5:3	Retry Setting	000	No retry. The output remains disabled until the fault is cleared.
		001-110	Not used.
		111	Attempts to restart continuously, without checking if the fault is still present, until it is commanded OFF (by the CONTROL pin or OPERATION command), bias power is removed, or another fault condition causes the unit to shut down.
2:0	Retry Delay	000-111	Retry delay time = (Value + 1) * 35ms. Sets the time between retries in 35ms increments.

**VOUT\_OV\_WARNING\_LIMIT (42h)**

**Definition:** Sets the  $V_{OUT}$  overvoltage warning threshold. Power-good signal is pulled low when output voltage goes higher than this threshold.

**Data Length in Bytes:** 2

**Data Format:** L16u

**Type:** R/W

**Default Value:** 0.85 x VOUT\_COMMAND pin-strap setting

**Units:** V

**Range:** 0V to VOUT\_MAX

**VOUT\_UV\_WARNING\_LIMIT (43h)**

**Definition:** Sets the  $V_{OUT}$  undervoltage warning threshold. The Power-good signal is pulled low when the output voltage goes lower than this threshold.

**Data Length in Bytes:** 2

**Data Format:** L16u

**Type:** R/W

**Default Value:** 0.85 x VOUT\_COMMAND pin-strap setting

**Units:** V

**Range:** 0V to VOUT\_MAX

**VOUT\_UV\_FAULT\_LIMIT (44h)**

**Definition:** Sets the  $V_{OUT}$  undervoltage fault threshold. This fault is masked during ramp or when disabled.

**Data Length in Bytes:** 2

**Data Format:** L16u

**Type:** R/W

**Default Value:** 0.85 x VOUT\_COMMAND pin-strap setting

**Units:** V

**Range:** 0V to VOUT\_MAX

**VOUT\_UV\_FAULT\_RESPONSE (45h)**

**Definition:** Configures the  $V_{OUT}$  undervoltage fault response.

**Data Length in Bytes:** 1

**Data Format:** BIT

**Type:** R/W

**Default Value:** 80h (Disable, no retry)

**Units:**

BIT	FIELD NAME	VALUE	DESCRIPTION
7:6	Reserved	10	
5:3	Retry Setting	000	No retry. The output remains disabled until the fault is cleared.
		001-110	Not used.
		111	Attempts to restart continuously, without checking if the fault is still present, until it is commanded OFF (by the CONTROL pin or OPERATION command), bias power is removed, or another fault condition causes the unit to shut down.
2:0	Retry Delay	000-111	Retry delay time = (Value + 1) * 35ms. Sets the time between retries in 35ms increments.

**IOUT\_OC\_FAULT\_LIMIT (46h)**

**Definition:** Sets the  $I_{OUT}$  average overcurrent fault threshold. Device will automatically calculate peak inductor overcurrent fault limit.

**Data Length in Bytes:** 2

**Data Format:** L11

**Type:** R/W

**Default Value:** E280h (40A)

**Units:** A

**Range:** -100A to 100A

**IOUT\_UC\_FAULT\_LIMIT (4Bh)**

**Definition:** Sets the  $I_{OUT}$  average undercurrent fault threshold. Device will automatically calculate valley inductor undercurrent fault limit.

**Data Length in Bytes:** 2

**Data Format:** L11

**Type:** R/W

**Default Value:** E57Fh (-40A)

**Units:** A

**Range:** -100A to 100A

**OT\_FAULT\_LIMIT (4Fh)**

**Definition:** Sets the temperature at which the device should indicate an over-temperature fault. Note that the temperature must drop below OT\_WARN\_LIMIT to clear this fault.

**Data Length in Bytes:** 2

**Data Format:** L11

**Type:** R/W

**Default Value:** EBE8h (+125°C)

**Units:** Celsius

**Range:** 0°C to +175°C



**OT\_FAULT\_RESPONSE (50h)**

**Definition:** Instructs the device on what action to take in response to an over-temperature fault.

**Data Length in Bytes:** 1

**Data Format:** BIT

**Type:** R/W

**fault Value:** 80h (Disable and no retry)

**Units:**

BIT	FIELD NAME	VALUE	DESCRIPTION
7:6	Reserved	10	
5:3	Retry Setting	000	No retry. The output remains disabled until the fault is cleared.
		001-110	Not used.
		111	Attempts to restart continuously, without checking if the fault is still present, until it is commanded OFF (by the CONTROL pin or OPERATION command), bias power is removed, or another fault condition causes the unit to shut down.
2:0	Retry Delay	000-111	Retry delay time = (Value + 1) * 35ms. Sets the time between retries in 35ms increments.

**OT\_WARN\_LIMIT (51h)**

**Definition:** Sets the temperature at which the device should indicate an over-temperature warning alarm. In response to the OT\_WARN\_LIMIT being exceeded, the device sets the TEMPERATURE bit in STATUS\_WORD, sets the OT\_WARNING bit in STATUS\_TEMPERATURE, and notifies the host.

**Data Length in Bytes:** 2

**Data Format:** Linear-11.

**Type:** R/W

**Default Value:** EB70h (+110 °C)

**Units:** Celsius

**Range:** 0 °C to +175 °C

**UT\_WARN\_LIMIT (52h)**

**Definition:** Sets the temperature at which the device should indicate an under-temperature warning alarm. In response to the UT\_WARN\_LIMIT being exceeded, the device sets the TEMPERATURE bit in STATUS\_WORD, sets the UT\_WARNING bit in STATUS\_TEMPERATURE, and notifies the host.

**Data Length in Bytes:** 2

**Data Format:** L11.

**Type:** R/W

**Default Value:** DC40h (-30 °C)

**Units:** Celsius

**Range:** -55 °C to +25 °C

**UT\_FAULT\_LIMIT (53h)**

**Definition:** Sets the temperature (in °C) at which the device should indicate an under-temperature fault. Note that the temperature must rise above UT\_WARN\_LIMIT to clear this fault.

**Data Length in Bytes:** 2

**Data Format:** L11

**Type:** R/W

**Default Value:** E530h (-45 °C)

**Units:** Celsius

**Range:** -55 °C to +25 °C

**UT\_FAULT\_RESPONSE (54h)**

**Definition:** Configures the under-temperature fault response as defined by the following table. The delay time is the time between restart attempts.

**Data Length in Bytes:** 1

**Data Format:** BIT

**Type:** R/W

**Default Value:** 80h (Disable, no retry)

**Units:**

BIT	FIELD NAME	VALUE	DESCRIPTION
7:6	Reserved	10	
5:3	Retry Setting	000	No retry. The output remains disabled until the fault is cleared.
		001-110	Not used.
		111	Attempts to restart continuously, without checking if the fault is still present, until it is commanded OFF (by the CONTROL pin or OPERATION command), bias power is removed, or another fault condition causes the unit to shut down.
2:0	Retry Delay	000-111	Retry delay time = (Value + 1) * 35ms. Sets the time between retries in 35ms increments.

**VIN\_OV\_FAULT\_LIMIT (55h)**

**Definition:** Sets the  $V_{IN}$  overvoltage fault threshold.

**Data Length in Bytes:** 2

**Data Format:** L11

**Type:** R/W

**Default Value:** D3A0h (14.5V)

**Units:** V

**Range:** 0V to 16V

**VIN\_OV\_FAULT\_RESPONSE (56h)**

**Definition:** Configures the  $V_{IN}$  overvoltage fault response as defined by the following table. The delay time is the time between restart attempts.

**Data Length in Bytes:** 1

**Data Format:** BIT

**Type:** R/W

**Default Value:** 80h (Disable and no retry)

**Units:**

BIT	FIELD NAME	VALUE	DESCRIPTION
7:6	Reserved	10	
5:3	Retry Setting	000	No retry. The output remains disabled until the fault is cleared.
		001-110	Not used.
		111	Attempts to restart continuously, without checking if the fault is still present, until it is commanded OFF (by the CONTROL pin or OPERATION command), bias power is removed, or another fault condition causes the unit to shut down.
2:0	Retry Delay	000-111	Retry delay time = (Value + 1) * 35ms. Sets the time between retries in 35ms increments.

**VIN\_OV\_WARN\_LIMIT (57h)**

**Definition:** Sets the VIN overvoltage warning threshold as defined by the table below. In response to the OV\_WARN\_LIMIT being exceeded, the device: Sets the NONE OF THE ABOVE and INPUT bits in STATUS\_WORD, sets the VIN\_OV\_WARNING bit in STATUS\_INPUT, and notifies the host.

**Data Length in Bytes:** 2

**Data Format:** L11.

**Type:** R/W

**Protectable:** Yes

**Default Value:** D34Dh (13.2V)

**Units:** V

**Range:** 0V to 16V

**VIN\_UV\_WARN\_LIMIT (58h)**

**Definition:** Sets the VIN undervoltage warning threshold. If a VIN\_UV\_FAULT occurs, the input voltage must rise above VIN\_UV\_WARN\_LIMIT to clear the fault, which provides hysteresis to the fault threshold. In response to the UV\_WARN\_LIMIT being exceeded, the device: Sets the NONE OF THE ABOVE and INPUT bits in STATUS\_WORD, sets the VIN\_UV\_WARNING bit in STATUS\_INPUT, and notifies the host.

**Data Length in Bytes:** 2

**Data Format:** Linear-11

**Type:** R/W

**Default Value:** 1.1 x VIN\_UV\_FAULT\_LIMIT pin-strap setting

**Units:** V

**Range:** 0V to 12V

**VIN\_UV\_FAULT\_LIMIT (59h)**

**Definition:** Sets the  $V_{IN}$  undervoltage fault threshold.

**Data Length in Bytes:** 2

**Data Format:** L11

**Type:** R/W

**Default Value:** Pin-strap setting

**Units:** V

**Range:** 0V to 12V

**VIN\_UV\_FAULT\_RESPONSE (5Ah)**

**Definition:** Configures the  $V_{IN}$  undervoltage fault response as defined by the following table. The delay time is the time between restart attempts.

**Data Length in Bytes:** 1

**Data Format:** BIT

**Type:** R/W

**Default Value:** 80h (Disable and no retry)

**Units:**

BIT	FIELD NAME	VALUE	DESCRIPTION
7:6	Reserved	10	
5:3	Retry Setting	000	No retry. The output remains disabled until the fault is cleared.
		001-110	Not used.
		111	Attempts to restart continuously, without checking if the fault is still present, until it is commanded OFF (by the CONTROL pin or OPERATION command), bias power is removed, or another fault condition causes the unit to shut down.
2:0	Retry Delay	000-111	Retry delay time = (Value + 1) * 35ms. Sets the time between retries in 35ms increments.

**POWER\_GOOD\_ON (5Eh)**

**Definition:** Sets the voltage threshold for Power-Good indication. Power-Good asserts when the output voltage exceeds POWER\_GOOD\_ON and de-asserts when the output voltage is less than VOUT\_UV\_FAULT\_LIMIT.

**Data Length in Bytes:** 2

**Data Format:** L16u

**Type:** R/W

**Default Value:** 0.9 x VOUT\_COMMAND pin-strap setting

**Units:** V

**TON\_DELAY (60h)**

**Definition:** Sets the delay time from when the device is enabled to the start of V<sub>OUT</sub> rise.

**Data Length in Bytes:** 2

**Data Format:** L11

**Type:** R/W

**Default Value:** CA80h (5ms)

**Units:** ms

**Range:** 0 to 500ms

**TON\_RISE (61h)**

**Definition:** Sets the rise time of V<sub>OUT</sub> after ENABLE and TON\_DELAY.

**Data Length in Bytes:** 2

**Data Format:** L11

**Type:** R/W

**Default Value:** CA80h (5ms)

**Units:** ms

**Range:** 0 to 200ms

**TOFF\_DELAY (64h)**

**Definition:** Sets the delay time from DISABLE to start of V<sub>OUT</sub> fall.

**Data Length in Bytes:** 2

**Data Format:** L11

**Type:** R/W

**Default Value:** CA80h (5ms)

**Units:** ms

**Range:** 0 to 256ms

**TOFF\_FALL (65h)**

**Definition:** Sets the fall time for V<sub>OUT</sub> after DISABLE and TOFF\_DELAY.

**Data Length in Bytes:** 2

**Data Format:** L11

**Type:** R/W

**Default Value:** CA80h (5ms)

**Units:** ms

**Range:** 0 to 200ms

**STATUS\_BYTE (78h)**

**Definition:** Returns one byte of information with a summary of the most critical faults.

**Data Length in Bytes:** 1

**Data Format:** BIT

**Type:** Read only

**Default Value:** 00h

**Units:** N/A

BIT NUMBER	STATUS BIT NAME	MEANING
7	BUSY	A fault was declared because the device was busy and unable to respond.
6	OFF	This bit is asserted if the unit is not providing power to the output, regardless of the reason, including simply not being enabled.
5	VOUT_OV_FAULT	An output overvoltage fault has occurred.
4	IOUT_OC_FAULT	An output overcurrent fault has occurred.
3	VIN_UV_FAULT	An input undervoltage fault has occurred.
2	TEMPERATURE	A temperature fault or warning has occurred.
1	CML	A communications, memory or logic fault has occurred.
0	NONE OF THE ABOVE	A fault or warning not listed in Bits 7:1 has occurred.

**STATUS\_WORD (79h)**

**Definition:** Returns two bytes of information with a summary of the unit's fault condition. Based on the information in these bytes, the host can get more information by reading the appropriate status registers. The low byte of the STATUS\_WORD is the same register as the STATUS\_BYTE (78h) command.

**Data Length in Bytes:** 2

**Data Format:** BIT

**Type:** Read only

**Default Value:** 0000h

**Units:** N/A

BIT NUMBER	STATUS BIT NAME	MEANING
15	VOUT	An output voltage fault or warning has occurred.
14	IOUT/POUT	An output current or output power fault or warning has occurred.
13	INPUT	An input voltage, input current, or input power fault or warning has occurred.
12	MFG_SPECIFIC	A manufacturer specific fault or warning has occurred.
11	POWER_GOOD#	The POWER_GOOD signal, if present, is negated.
10	FANS	A fan or airflow fault or warning has occurred.
9	OTHER	A bit in STATUS_OTHER is set.
8	UNKNOWN	A fault type not given in Bits 15:1 of the STATUS_WORD has been detected.
7	BUSY	A fault was declared because the device was busy and unable to respond.
6	OFF	This bit is asserted if the unit is not providing power to the output, regardless of the reason, including simply not being enabled.
5	VOUT_OV_FAULT	An output overvoltage fault has occurred.
4	IOUT_OC_FAULT	An output overcurrent fault has occurred.
3	VIN_UV_FAULT	An input undervoltage fault has occurred.
2	TEMPERATURE	A temperature fault or warning has occurred.
1	CML	A communications, memory or logic fault has occurred.
0	NONE OF THE ABOVE	A fault or warning not listed in Bits 7:1 has occurred.

**STATUS\_VOUT (7Ah)**

**Definition:** Returns one data byte with the status of the output voltage.

**Data Length in Bytes:** 1

**Data Format:** BIT

**Type:** Read only

**Default Value:** 00h

**Units:** N/A

BIT NUMBER	STATUS BIT NAME	MEANING
7	VOUT_OV_FAULT	Indicates an output overvoltage fault.
6	VOUT_OV_WARNING	Indicates an output overvoltage warning.
5	VOUT_UV_WARNING	Indicates an output undervoltage warning.
4	VOUT_UV_FAULT	Indicates an output undervoltage fault.
3:0	N/A	These bits are not used.

**STATUS\_IOUT (7Bh)**

**Definition:** Returns one data byte with the status of the output current.

**Data Length in Bytes:** 1

**Data Format:** BIT

**Type:** Read only

**Default Value:** 00h

**Units:** N/A

BIT NUMBER	STATUS BIT NAME	MEANING
7	IOUT_OC_FAULT	An output overcurrent fault has occurred.
6	IOUT_OC_LV_FAULT	An output overcurrent and low voltage fault has occurred.
5	IOUT_OC_WARNING	An output overcurrent warning has occurred.
4	IOUT_UC_FAULT	An output undercurrent fault has occurred.
3:0	N/A	These bits are not used.

**STATUS\_INPUT (7Ch)**

**Definition:** Returns input voltage and input current status information.

**Data Length in Bytes:** 1

**Data Format:** BIT

**Type:** Read only

**Default Value:** 00h

**Units:** N/A

BIT NUMBER	STATUS BIT NAME	MEANING
7	VIN_OV_FAULT	An input overvoltage fault has occurred.
6	VIN_OV_WARNING	An input overvoltage warning has occurred.
5	VIN_UV_WARNING	An input undervoltage warning has occurred.
4	VIN_UV_FAULT	An input undervoltage fault has occurred.
3:0	N/A	These bits are not used.

**STATUS\_TEMP (7Dh)**

**Definition:** Returns one byte of information with a summary of any temperature related faults or warnings.

**Data Length in Bytes:** 1

**Data Format:** BIT

**Type:** Read only

**Default Value:** 00h

**Units:** N/A

BIT NUMBER	STATUS BIT NAME	MEANING
7	OT_FAULT	An over-temperature fault has occurred.
6	OT_WARNING	An over-temperature warning has occurred.
5	UT_WARNING	An under-temperature warning has occurred.
4	UT_FAULT	An under-temperature fault has occurred.
3:0	N/A	These bits are not used.

**STATUS\_CML (7Eh)**

**Definition:** Returns one byte of information with a summary of any Communications, Logic and/or Memory errors.

**Data Length in Bytes:** 1

**Data Format:** BIT

**Type:** Read only

**Default Value:** 00h

**Units:** N/A

BIT NUMBER	MEANING
7	Invalid or unsupported PMBus command was received.
6	The PMBus command was sent with invalid or unsupported data.
5	packet error was detected in the PMBus command.
4:2	Not Used.
1	A PMBus command tried to write to a read only or protected command, or a communication fault other than the ones listed in this table has occurred.
0	Not Used.

**STATUS\_MFR\_SPECIFIC (80h)**

**Definition:** Returns one byte of information providing the status of the device's voltage monitoring and clock synchronization faults. VDRV OV/UV warnings are set at  $\pm 10\%$  of the VMON\_FAULT commands.

**Data Length in Bytes:** 1

**Data Format:** BIT

**Type:** Read only

**Default value:** 00h

**Units:** N/A

BIT NUMBER	FIELD NAME	MEANING
7:6	Reserved	
5	VMON UV Warning	The voltage on the VMON pin has dropped 10% above the level set by MFR_VMON_UV_FAULT_LIMIT.
4	VMON OV Warning	The voltage on the VMON pin has risen 10% below the level set by MFR_VMON_OV_FAULT_LIMIT.
3	External Switching Period Fault	Loss of external clock synchronization has occurred.
2	Reserved	
1	VMON UV Fault	The voltage on the VMON pin has dropped below the level set by MFR_VMON_UV_FAULT.
0	VMON OV Fault	The voltage on the VMON pin has risen above the level set by MFR_VMON_OV_FAULT.

**READ\_VIN (88h)**

**Definition:** Returns the input voltage reading.

**Data Length in Bytes:** 2

**Data Format:** L11

**Type:** Read only

**Units:** V

**READ\_VOUT (8Bh)**

**Definition:** Returns the output voltage reading.

**Data Length in Bytes:** 2

**Data Format:** L16u

**Type:** Read only

**Units:** V

**READ\_IOUT (8Ch)**

**Definition:** Returns the output current reading.

**Data Length in Bytes:** 2

**Data Format:** L11

**Type:** Read only

**Default Value:** N/A

**Units:** A

**READ\_TEMPERATURE\_1 (8Dh)**

**Definition:** Returns the controller junction temperature reading from internal temperature sensor.

**Data Length in Bytes:** 2

**Data Format:** L11

**Type:** Read only

**Units:** °C

**READ\_TEMPERATURE\_2 (8Eh)**

**Definition:** Returns the temperature reading from the external temperature device connected to XTEMP pins.

**Data Length in Bytes:** 2

**Data Format:** L11

**Type:** Read only

**Units:** °C

**READ\_DUTY\_CYCLE (94h)**

**Definition:** Reports the actual duty cycle of the converter during the enable state.

**Data Length in Bytes:** 2

**Data Format:** L11

**Type:** Read only

**Units:** %

**READ\_FREQUENCY (95h)**

**Definition:** Reports the actual switching frequency of the converter during the enable state.

**Data Length in Bytes:** 2

**Data Format:** L11

**Type:** Read only

**Units:** kHz



**MFR\_ID (99h)**

**Definition:** Stores information from the manufacturing process. The sum total of characters in MFR\_ID, MFR\_MODEL, MFR\_REVISION, MFR\_LOCATION, MFR\_DATE, MFR\_SERIAL, and USER\_DATA\_00 plus one byte per command cannot exceed 128 characters. This limitation includes multiple writes of this command before a STORE command. To clear multiple writes, perform a RESTORE, write this command then perform a STORE/RESTORE.

**Data Length in Bytes:** User defined

**Data Format:** ASCII

**Type:** Block R/W

**Default Value:** Manufacturing information

**Units:** N/A

**MFR\_MODEL (9Ah)**

**Definition:** Sets a user defined model. The sum total of characters in MFR\_ID, MFR\_MODEL, MFR\_REVISION, MFR\_LOCATION, MFR\_DATE, MFR\_SERIAL and USER\_DATA\_00 plus one byte per command cannot exceed 128 characters. This limitation includes multiple writes of this command before a STORE command. To clear multiple writes, perform a RESTORE, write this command then perform a STORE/RESTORE.

**Data Length in Bytes:** User defined

**Data Format:** ASC

**Type:** Block R/W

**Default Value:** null

**Units:** N/A

**MFR\_REVISION (9Bh)**

**Definition:** Sets a user defined revision. The sum total of characters in MFR\_ID, MFR\_MODEL, MFR\_REVISION, MFR\_LOCATION, MFR\_DATE, MFR\_SERIAL, and USER\_DATA\_00 plus one byte per command cannot exceed 128 characters. This limitation includes multiple writes of this command before a STORE command. To clear multiple writes, perform a RESTORE, write this command then perform a STORE/RESTORE.

**Data Length in Bytes:** User defined

**Data Format:** ASC

**Type:** Block R/W

**Default Value:** null

**Units:** N/A

**MFR\_LOCATION (9Ch)**

**Definition:** Sets a user defined location identifier. The sum total of characters in MFR\_ID, MFR\_MODEL, MFR\_REVISION, MFR\_LOCATION, MFR\_DATE, MFR\_SERIAL, and USER\_DATA\_00 plus one byte per command cannot exceed 128 characters. This limitation includes multiple writes of this command before a STORE command. To clear multiple writes, perform a RESTORE, write this command then perform a STORE/RESTORE.

**Data Length in Bytes:** User defined

**Data Format:** ASC

**Type:** Block R/W

**Default Value:** null

**Units:** N/A

**MFR\_DATE (9Dh)**

**Definition:** Sets a user defined date. The sum total of characters in MFR\_ID, MFR\_MODEL, MFR\_REVISION, MFR\_LOCATION, MFR\_DATE, MFR\_SERIAL, and USER\_DATA\_00 plus one byte per command cannot exceed 128 characters. This limitation includes multiple writes of this command before a STORE command. To clear multiple writes, perform a RESTORE, write this command then perform a STORE/RESTORE.

**Data Length in Bytes:** User defined

**Data Format:** ASC

**Type:** Block R/W

**Default Value:** null

**Units:** N/A

**Reference:** N/A

**MFR\_SERIAL (9Eh)**

**Definition:** Sets a user defined serialized identifier. The sum total of characters in MFR\_ID, MFR\_MODEL, MFR\_REVISION, MFR\_LOCATION, MFR\_DATE, MFR\_SERIAL, and USER\_DATA\_00 plus one byte per command cannot exceed 128 characters. This limitation includes multiple writes of this command before a STORE command. To clear multiple writes, perform a RESTORE, write this command then perform a STORE/RESTORE.

**Data Length in Bytes:** User defined

**Data Format:** ASC

**Type:** Block R/W

**Default Value:** null

**Units:** N/A

**LEGACY\_FAULT\_GROUP (A8h)**

**Definition:** Used only when the power system is created by mixing the ISL8271M module with older generation digital modules (ZL9101M, ZL9117M, ZL9006M, ZL9010M) to power various rails. This command provides an ability to power down the system by broadcasting faults between old and new generation digital modules.

The new generation modules use the group ID to broadcast faults among each other. Refer to the DDC\_GROUP(E2h) command. The older generation modules use the rail ID to broadcast faults. When new and old modules are mixed, the ISL8271M can use the GROUP-ID (new generation module) and/or RAIL-ID (old generation module) to execute a shutdown as a response to a fault in the selected GROUP\_ID or RAIL-ID. A module can listen to multiple RAIL-IDs by writing 1 to a bit location that represents the RAIL-ID of the old generation modules.

**Note:** Bit-5 in the DDC\_GROUP command should be programmed 1 to activate fault broadcast.

**Data Length in Bytes:** 4

**Data Format:** BIT

**Type:** R/W Block

**Default Value:** 00000000h

**Units:** N/A

TABLE 7.

BIT	DESCRIPTION	BIT	DESCRIPTION	BIT	DESCRIPTION	BIT	DESCRIPTION
31	Listen to Rail-31	23	Listen to Rail-23	15	Listen to Rail-15	7	Listen to Rail-7
30	Listen to Rail-30	22	Listen to Rail-22	14	Listen to Rail-14	6	Listen to Rail-6
29	Listen to Rail-29	21	Listen to Rail-21	13	Listen to Rail-13	5	Listen to Rail-5
28	Listen to Rail-28	20	Listen to Rail-20	12	Listen to Rail-12	4	Listen to Rail-4
27	Listen to Rail-27	19	Listen to Rail-19	11	Listen to Rail-11	3	Listen to Rail-3
26	Listen to Rail-26	18	Listen to Rail-18	10	Listen to Rail-10	2	Listen to Rail-2
25	Listen to Rail-25	17	Listen to Rail-17	9	Listen to Rail-9	1	Listen to Rail-1
24	Listen to Rail-24	16	Listen to Rail-16	8	Listen to Rail-8	0	Listen to Rail-0

**USER\_DATA\_00 (B0h)**

**Definition:** Sets user defined data. The sum total of characters in MFR\_ID, MFR\_MODEL, MFR\_REVISION, MFR\_LOCATION, MFR\_DATE, MFR\_SERIAL, and USER\_DATA\_00 plus one byte per command cannot exceed 128 characters. This limitation includes multiple writes of this command before a STORE command. To clear multiple writes, perform a RESTORE, write this command, then perform a STORE/RESTORE.

**Data Length in Bytes:** User defined

**Data Format:** ASCII

**Type:** Block R/W

**Default Value:** null

**Units:** N/A

**ISENSE\_CONFIG (D0h)****Definition:** Configures current sense circuitry.**Data Length in Bytes:** 1**Data Format:** BIT**Type:** R/W Byte**Default Value:** 05h**Units:** N/A

BIT	FIELD NAME	VALUE	SETTING	DESCRIPTION
7:4	Reserved	000		
3:2	Current Sense Blanking Time	00	192ns	Sets the current sense blanking time.
		01	256ns	
		10	412ns	
		11	640ns	
1:0	Current Sense Range	00	Low Range	±25mV
		01	Mid Range	±35mV
		10	High Range	±50mV
		11	Not Used	

**USER\_CONFIG (D1h)****Definition:** Configures several user-level features. This command overrides the CONFIG pin settings.**Data Length in Bytes:** 1**Data Format:** BIT**Type:** R/W Byte**Default Value:** 00h**Units:** N/A

BIT	FIELD NAME	VALUE	SETTING	DESCRIPTION
7:5	Reserved	0		Reserved.
4:3	Ramp-Up and Ramp-Down Minimum Duty Cycle	00	0.39%	Sets the minimum duty-cycle during start-up and shutdown ramp. Must be enabled with Bit 10.
		01	0.78%	
		10	1.17%	
		11	1.56%	
2	Minimum Duty Cycle Control	0	Disable	Control for minimum duty cycle.
		1	Enable	
1	Power-Good Pin Configuration	0	Open Drain	0 = PG is open drain output. 1 = PG is push-pull output.
		1	Push-Pull	
0	XTEMP Enable	0	Disable	Enable external temperature monitoring.
		1	Enable	

**DDC\_CONFIG (D3h)****Definition:** Configures DDC addressing.**Data Length in Bytes:** 1**Data Format:** BIT**Type:** R/W**Default Value:** 00h**Units:** N/A

BIT	FIELD NAME	VALUE	SETTING	DESCRIPTION
7:5	Reserved	00	Reserved	Reserved.
4:0	Rail ID	0 to 31 (00 to 1Fh)	0	Configures DDC address

**POWER\_GOOD\_DELAY (D4h)**

**Definition:** Sets the delay applied between the output exceeding the PG threshold (POWER\_GOOD\_ON) and asserting the PG pin. The delay time can range from 0ms up to 500ms, in steps of 125ns. A 1ms minimum configured value is recommended to apply proper de-bounce to this signal.

**Data Length in Bytes:** 2

**Data Format:** L11

**Type:** R/W

**Default Value:** CA00 (4ms)

**Units:** ms

**Range:** 0 to 5s

**ASCR\_CONFIG (DFh)**

**Definition:** Allows user configuration of ASCR settings.

**Data Length in Bytes:** 4

**Data Format:** CUS

**Type:** R/W

**Default Value:** 015A0100h

BIT	PURPOSE	DATA Format	VALUE	DESCRIPTION
31:25	Unused		0000000h	Unused
24	ASCCR Enable	BIT	1	Enable
			0	Disable
23:16	ASCR Residual Setting	Integer		
15:0	ASCR Gain Setting	Integer		

**SEQUENCE (E0h)**

**Definition:** Identifies the Rail DDC ID of the prequel and sequel rails when performing multi-rail sequencing. The device will enable its output when its EN or OPERATION enable states, as defined by ON\_OFF\_CONFIG, is set and the prequel device has issued a power-good event on the DDC bus. The device will disable its output (using the programmed delay values) when the sequel device has issued a power-down event on the DDC bus.

The data field is a two-byte value. The most-significant byte contains the 5-bit Rail DDC ID of the prequel device. The least-significant byte contains the 5-bit Rail DDC ID of the sequel device. The most significant bit of each byte contains the enable of the prequel or sequel mode. This command overrides the corresponding sequence configuration set by the CONFIG pin settings.

**Data Length in Bytes:** 2

**Data Format:** BIT

**Type:** R/W

**Default Value:** 0000h (Prequel and Sequel disabled)

BIT	FIELD NAME	VALUE	SETTING	DESCRIPTION
15	Prequel Enable	0	Disable	Disable, no prequel preceding this rail.
		1	Enable	Enable, prequel to this rail is defined by Bits 12:8.
14:13	Reserved	0	Reserved	Reserved.
12:8	Prequel Rail DDC ID	0-31	DDC ID	Set to the DDC ID of the prequel rail.
7	Sequel Enable	0	Disable	Disable, no sequel following this rail.
		1	Enable	Enable, sequel to this rail is defined by Bits 4:0.
6:5	Reserved	0	Reserved	Reserved.
4:0	Sequel Rail DDC ID	0-31	DDC ID	Set to the DDC ID of the sequel rail.

**DDC\_GROUP (E2h)**

**Definition:** Configures the fault spreading group ID and enable, broadcast OPERATION group ID and enable, and broadcast VOUT\_COMMAND group ID and enable.

**Data Length in Bytes:** 3

**Data Format:** BIT

**Type:** R/W

**Default Value:** 000000h (Ignore BROADCAST VOUT\_COMMAND and OPERATION, Sequence shutdown on POWER\_FAIL event)

BITS	PURPOSE	VALUE	DESCRIPTION
23:22	Reserved	0	Reserved
21	BROADCAST_VOUT_COMMAND Response	1	Responds to BROADCAST_VOUT_COMMAND with same Group ID.
		0	Ignores BROADCAST_VOUT_COMMAND.
20:16	BROADCAST_VOUT_COMMAND Group ID	0-31d	Group ID sent as data for broadcast BROADCAST_VOUT_COMMAND events.
15:14	Reserved	0	Reserved.
13	BROADCAST_OPERATION Response	1	Responds to BROADCAST_OPERATION with same Group ID.
		0	Ignores BROADCAST_OPERATION.
12:8	BROADCAST_OPERATION Group ID	0-31d	Group ID sent as data for broadcast BROADCAST_OPERATION events.
7:6	Reserved	0	Reserved.
5	POWER_FAIL Response	1	Responds to POWER_FAIL events with same Group ID by shutting down immediately.
		0	Responds to POWER_FAIL events with same Group ID with sequenced shutdown.
4:0	POWER_FAIL group ID	0-31d	Group ID sent as data for broadcast POWER_FAIL events.

**DEVICE\_ID (E4h)**

**Definition:** Returns the 16-byte (character) device identifier string.

**Data Length in Bytes:** 16

**Data Format:** ASCII

**Type:** Block Read

**Default Value:** Part number/Die revision/Firmware revision

**MFR\_IOUT\_OC\_FAULT\_RESPONSE (E5h)**

**Definition:** Configures the I<sub>OUT</sub> overcurrent fault response as defined by the following table. The command format is the same as the PMBus standard fault responses except that it sets the overcurrent status bit in STATUS\_IOUT.

**Data Length in Bytes:** 1

**Data Format:** BIT

**Type:** R/W

**Default Value:** 80h (Disable and no retry)

**Units:**

BIT	FIELD NAME	VALUE	DESCRIPTION
7:6	Reserved	10	
5:3	Retry Setting	000	No retry. The output remains disabled until the fault is cleared.
		001-110	Not used.
		111	Attempts to restart continuously, without checking if the fault is still present, until it is commanded OFF (by the CONTROL pin or OPERATION command), bias power is removed, or another fault condition causes the unit to shut down.
2:0	Retry Delay	000-111	Retry delay time = (Value + 1) * 35ms. Sets the time between retries in 35ms increments.

**MFR\_IOUT\_UC\_FAULT\_RESPONSE (E6h)**

**Definition:** Configures the I<sub>OUT</sub> undercurrent fault response as defined by the following table. The command format is the same as the PMBus standard fault responses except that it sets the undercurrent status bit in STATUS\_IOUT.

**Data Length in Bytes:** 1

**Data Format:** BIT

**Type:** R/W

**Default Value:** 80h (Disable and no retry)

**Units:**

BIT	FIELD NAME	VALUE	DESCRIPTION
7:6	Reserved	10	
5:3	Retry Setting	000	No retry. The output remains disabled until the fault is cleared.
		001-110	Not used.
		111	Attempts to restart continuously, without checking if the fault is still present, until it is commanded OFF (by the CONTROL pin or OPERATION command), bias power is removed, or another fault condition causes the unit to shut down.
2:0	Retry Delay	000-111	Retry delay time = (Value + 1) * 35ms. Sets the time between retries in 35ms increments.

**SYNC\_CONFIG (E9h)**

**Definition:** Sets options for SYNC output configurations.

**Data Length in Bytes:** 1

**Data Format:** BIT

**Type:** R/W

**Default Value:** 00h

SETTINGS	ACTIONS
00h	Use Internal clock. Clock frequency is set by pin-strap or PMBus command.
02h	Use internal clock and output internal clock.
04h	Use external clock.

## SNAPSHOT (EAh)

**Definition:** A 32-byte read-back of parametric and status values. It allows monitoring and status data to be stored to flash following a fault condition. In case of a fault, last updated values are stored to the flash memory. When SNAPSHOT STATUS byte (22) is set stored, device will no longer automatically capture parametric and status values following fault till stored data are erased. Use SNAPSHOT\_CONTROL command to erase store data and clear the status bit before next ramp up. Data erased is not allowed when module is enabled.

**Data Length in Bytes:** 32

**Data Format:** Bit field

**Type:** Block Read

BYTE NUMBER	VALUE	PMBUS COMMAND	FORMAT
31:23	Reserved	Reserved	00h
22	Flash Memory Status Byte FF - Not Stored 00 - Stored	N/A	BIT
21	Manufacturer Specific Status Byte	STATUS_MFR_SPECIFIC (80h)	Byte
20	CML Status Byte	STATUS_CML (7Eh)	Byte
19	Temperature Status Byte	STATUS_TEMPERATURE (7Dh)	Byte
18	Input Status Byte	STATUS_INPUT (7Ch)	Byte
17	I <sub>OUT</sub> Status Byte	STATUS_IOUT (7Bh)	Byte
16	V <sub>OUT</sub> Status Byte	STATUS_VOUT (7Ah)	Byte
15:14	Switching Frequency	READ_FREQUENCY (95h)	L11
13:12	External Temperature	READ_EXTERNAL_TEMP (8Eh)	L11
11:10	Internal Temperature	READ_INTERNAL_TEMP (8Dh)	L11
9:8	Duty Cycle	READ_DUTY_CYCLE (94h)	L11
7:6	Highest Measured Output Current	N/A	L11
5:4	Output Current	READ_IOUT (8Ch)	L11
3:2	Output Voltage	READ_VOUT (8Bh)	L16u
1:0	Input Voltage	READ_VIN (88h)	L11

## BLANK\_PARAMS (EBh)

**Definition:** Returns a 16-byte string indicating which parameter values were either retrieved by the last RESTORE operation or have been written since that time. Reading BLANK\_PARAMS immediately after a restore operation allows the user to determine which parameters are stored in that store. A one indicates the parameter is not present in the store and has not been written since the RESTORE operation.

**Data Length in Bytes:** 16

**Data Format:** BIT

**Type:** Block Read

**Default Value:** FF...FFh

## SNAPSHOT\_CONTROL (F3h)

**Definition:** Erases parametric and status values stored at SNAPSHOT in flash memory.

**Data Length in Bytes:** 1

**Data Format:** Bit field

**Type:** R/W byte

VALUE	DESCRIPTION
02h	Write Snapshot values to NV RAM.
03h	Erase Snapshot values stored in NV RAM.

---

**RESTORE\_FACTORY (F4h)**

**Definition:** Restores the device to the hard-coded factory default values and pin-strap definitions. The device retains the DEFAULT and USER stores for restoring. Security level is changed to Level 1 following this command.

**Data Length in Bytes:** 0

**Data Format:** N/A

**Type:** Send byte

**Default Value:** N/A

**Units:** N/A

**MFR\_VMON\_OV\_FAULT\_LIMIT (F5h)**

**Definition:** Reads the VDRV OV fault threshold.

**Data Length in Bytes:** 2

**Data Format:** L11

**Type:** Read only

**Default Value:** CB00h (6V)

**Units:**

**Range:** 4V to 6V

**MFR\_VMON\_UV\_FAULT\_LIMIT (F6h)**

**Definition:** Reads the VDRV UV fault threshold

**Data Length in Bytes:** 2

**Data Format:** L11

**Type:** Read only

**Default Value:** CA00h (4V)

**Units:** V

**Range:** 4V to 6V

**MFR\_READ\_VMON (F7h)**

**Definition:** Reads the VDRV voltage.

**Data Length in Bytes:** 2

**Data Format:** L11

**Type:** Read only

**Default Value:** N/A

**Units:** V

**Range:** 4V to 6V

**VMON\_OV\_FAULT\_RESPONSE (F8h)**

**Definition:** Reads the VDRV OV fault response

**Data Length in Bytes:** 1

**Data Format:** BIT

**Type:** Read only

**Default Value:** 80h (Disable and no retry)

**Units:** N/A

**VMON\_UV\_FAULT\_RESPONSE (F9h)**

**Definition:** Reads the VDRV UV fault response

**Data Length in Bytes:** 1

**Data Format:** BIT

**Type:** Read only

**Default Value:** 80h (Disable and no retry)

**Units:** N/A



## Revision History

The revision history provided is for informational purposes only and is believed to be accurate, but not warranted. Please visit our website to make sure you have the latest revision.

DATE	REVISION	CHANGE
Aug 17, 2017	FN8636.4	<p>Updated the "Related Literature" section on page 1.</p> <p>Added the ISL8271MBIRZ and firmware revisions to "Ordering Information" on page 3.</p> <p>For "SMBus Communications" on page 16, added the last paragraph.</p> <p>For "Switching Frequency and PLL" and "Input Undervoltage Lockout (UVLO)" on page 17, added "A standard 1% resistor is required if using pin-strap."</p> <p>In "Monitoring Using SMBus" on page 20, changed "READ_INTERNAL_TEMP" to "READ_TEMPERATURE_1", "READ_EXTERNAL_TEMP" to "READ_TEMPERATURE_2", and "READ_VDRV" to "MFR_READ_VMON".</p> <p>For "VIN_OV_FAULT_LIMIT (55h)", changed the default value from "D380h" to "D3A0h" and the default setting from "14V" to "14.5V".</p> <p>For "VIN_OV_WARN_LIMIT (57h)", changed the default value from "D327h" to "D34Dh" and the default setting from "12.6V" to "13.2V".</p> <p>For "PMBus Command Description" on page 27, changed "READ_INTERNAL_TEMP" to "READ_TEMPERATURE_1" and "READ_EXTERNAL_TEMP" to "READ_TEMPERATURE_2".</p> <p>For "MFR_ID (99h)" on page 41, changed the default setting from "Null" to "Manufacturing information".</p> <p>For "RESTORE_FACTORY (F4h)" on page 48, changed the type from "R/W BLOCK" to "SEND BYTE".</p> <p>Changed "VDRV_OV_FAULT_LIMIT" to "MFR_VMON_OV_FAULT_LIMIT".</p> <p>Changed "VDRV_UV_FAULT_LIMIT" to "MFR_VMON_UV_FAULT_LIMIT".</p> <p>Changed "READ_VDRV" to "MFR_READ_VMON".</p> <p>Changed "VDRV_OV_FAULT_RESPONSE" to "VMON_OV_FAULT_RESPONSE".</p> <p>Changed "VDRV_UV_FAULT_RESPONSE" to "VMON_UV_FAULT_RESPONSE".</p> <p>In "PMBus Use Guidelines" on page 27, added the last sentence: "Commands not listed in the PMBus command summary are not allowed for customer use, and are reserved for factory use only. Issuing reserved commands may result in unexpected operation."</p> <p>For "Firmware Revision History" on page 50, added ISL8271-000-FC02.</p> <p>Updated POD Y40.17x19 from revision 2 to revision 3. Changes since revision 2:</p> <ul style="list-style-type: none"> <li>Recommended Land Pattern updated to new Solder mask defined windows for improved SMT process.</li> <li>Recommended Stencil Pattern updated to match new Land Pattern.</li> <li>Positions of various dimensions moved to make the drawing more readable.</li> </ul> <p>For PMBus commands 03h, 15h, and 16h, changed type to "Send byte".</p> <p>For PMBus command 4Bh changed default value to "E57Fh (-40A)".</p> <p>For PMBus commands 60H, 61H, 64H, and 65H, changed default value to "CA80h (5ms)".</p> <p>For PMBus command D4h, changed default value to "CA00 (4ms)".</p> <p>For PMBus command E0h, changed default value to "0000h (Prequel and Sequel disabled)".</p> <p>For PMBus command E2h, changed default value to "000000h (Ignore BROADCAST VOUT_COMMAND and OPERATION, Sequence shutdown on POWER_FAIL event)".</p> <p>For PMBus command E9h, changed default value to "00h" and the Data Length in Bytes to "1".</p> <p>For PMBus command EBh, changed default value to "FF...FFh".</p> <p>For PMBus command 64h, changed range to "0 to 256ms".</p> <p>For PMBus commands F8h and F9h, changed units to "N/A".</p> <p>For PMBus commands 25h and 26h, changed data format to "L16u".</p> <p>For PMBus command F4h, changed type to "Send byte".</p> <p>For PMBus command 80h, on VMON UV Warning, changed "below" to "above" and changed "MFR_VMON_UV_FAULT" to "MFR_VMON_UV_FAULT_LIMIT".</p> <p>For PMBus command 80h, on VMON OV Warning, changed "below" to "above" and changed "MFR_VMON_UV_FAULT" to "MFR_VMON_UV_FAULT_LIMIT".</p>
Jun 17, 2016	FN8636.3	<p>Updated "Ordering Information" on page 3.</p> <p>Updated Note 2 by adding Tape and Reel option.</p> <p>Updated Note 3 by adding exemption 7A.</p> <p>Changed "VOUT_MAX (24h)" on page 29 - 0V to 4V to 0V to 5.5V.</p>
Mar 16, 2016	FN8636.2	<p>Added "PMBus Use Guidelines" on page 27.</p> <p>Updated POD Y40.17x19 to the latest revision changes are as follows:</p> <ul style="list-style-type: none"> <li>-Detail A on page 1: Added corner radius on individual I/O pads.</li> </ul>
Dec 18, 2014	FN8636.1	<p>For "Electrical Specifications" on page 7 under VOUT_ACCY and VOUT_READ_ERR, updated unit value from "% FS" to "%VOUT".</p>
Aug 11, 2014	FN8636.0	Initial release

## Firmware Revision History

TABLE 8. ISL8271M NOMENCLATURE GUIDE

FIRMWARE REVISION CODE	CHANGE DESCRIPTION	NOTE
ISL8271-000-FC02	Fixed bug: PMBus address read issue at low temperature Fixed bug: PMBus locks up when noise is present Corrected snapshot functionality behavior Changed VIN_OV_WARN_LIMIT to 13.2V Changed VIN_OV_FAULT_LIMIT to 14.5V	Recommended for new designs
ISL8271-000-FC01	Initial release	Not recommended for new designs

## About Intersil

Intersil Corporation is a leading provider of innovative power management and precision analog solutions. The company's products address some of the largest markets within the industrial and infrastructure, mobile computing and high-end consumer markets.

For the most updated datasheet, application notes, related documentation and related parts, please see the respective product information page found at [www.intersil.com](http://www.intersil.com).

For a listing of definitions and abbreviations of common terms used in our documents, visit [www.intersil.com/glossary](http://www.intersil.com/glossary).

You can report errors or suggestions for improving this datasheet by visiting [www.intersil.com/ask](http://www.intersil.com/ask).

Reliability reports are also available from our website at [www.intersil.com/support](http://www.intersil.com/support)

© Copyright Intersil Americas LLC 2014-2017. All Rights Reserved.  
All trademarks and registered trademarks are the property of their respective owners.

For additional products, see [www.intersil.com/en/products.html](http://www.intersil.com/en/products.html)

Intersil products are manufactured, assembled and tested utilizing ISO9001 quality systems as noted in the quality certifications found at [www.intersil.com/en/support/qualandreliability.html](http://www.intersil.com/en/support/qualandreliability.html)

*Intersil products are sold by description only. Intersil may modify the circuit design and/or specifications of products at any time without notice, provided that such modification does not, in Intersil's sole judgment, affect the form, fit or function of the product. Accordingly, the reader is cautioned to verify that datasheets are current before placing orders. Information furnished by Intersil is believed to be accurate and reliable. However, no responsibility is assumed by Intersil or its subsidiaries for its use; nor for any infringements of patents or other rights of third parties which may result from its use. No license is granted by implication or otherwise under any patent or patent rights of Intersil or its subsidiaries.*

For information regarding Intersil Corporation and its products, see [www.intersil.com](http://www.intersil.com)

# Package Outline Drawing

## Y40.17x19

For the most recent package outline drawing, see [Y40.17x19](#).

40 I/O 17.0mm x 19.0mm x 3.55mm HDA MODULE

Rev 3, 4/17

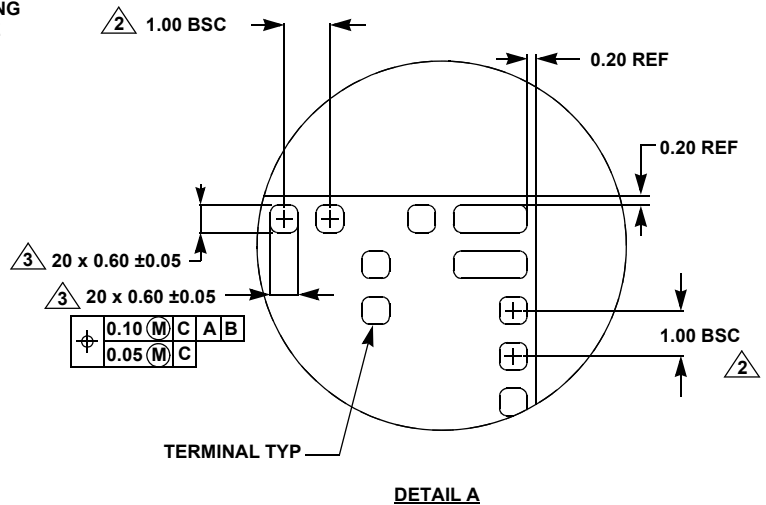
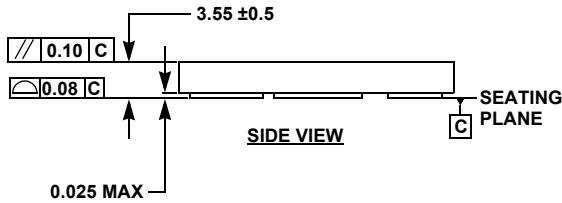
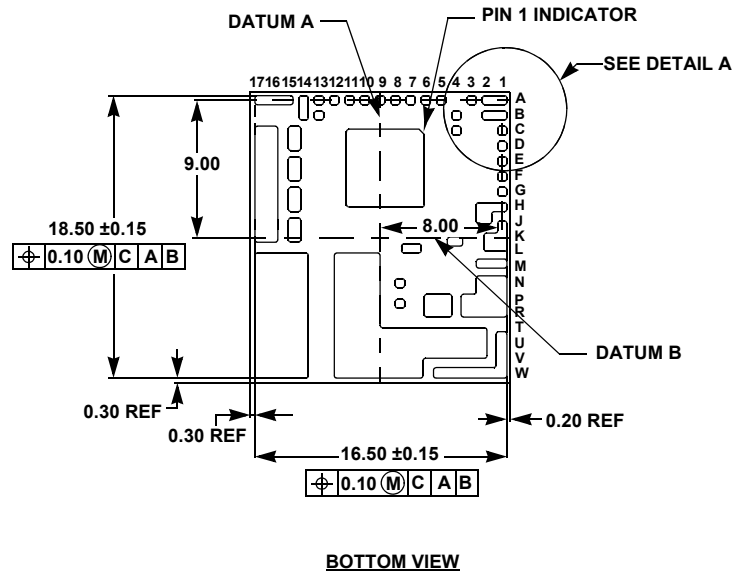
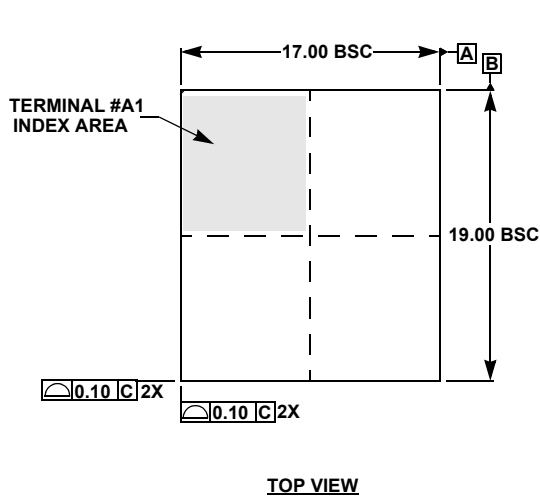

**NOTES:**

1. ALL DIMENSIONS ARE IN MILLIMETERS.
- ② REPRESENTS THE BASIC LAND GRID PITCH.
- ③ THE TOTAL NUMBER OF I/O (EXCLUDING DUMMY PADS)
4. UNLESS OTHERWISE SPECIFIED, TOLERANCE: DECIMAL ±0.10
5. DIMENSIONING AND TOLERANCING PER ASME Y14.M-2009
6. THE CONFIGURATION OF THE PIN#1 IDENTIFIER IS OPTIONAL, BUT MUST BE LOCATED WITHIN THE ZONE INDICATED. THE PIN #1 IDENTIFIER MAY BE EITHER A MOLD OR MARK FEATURE.





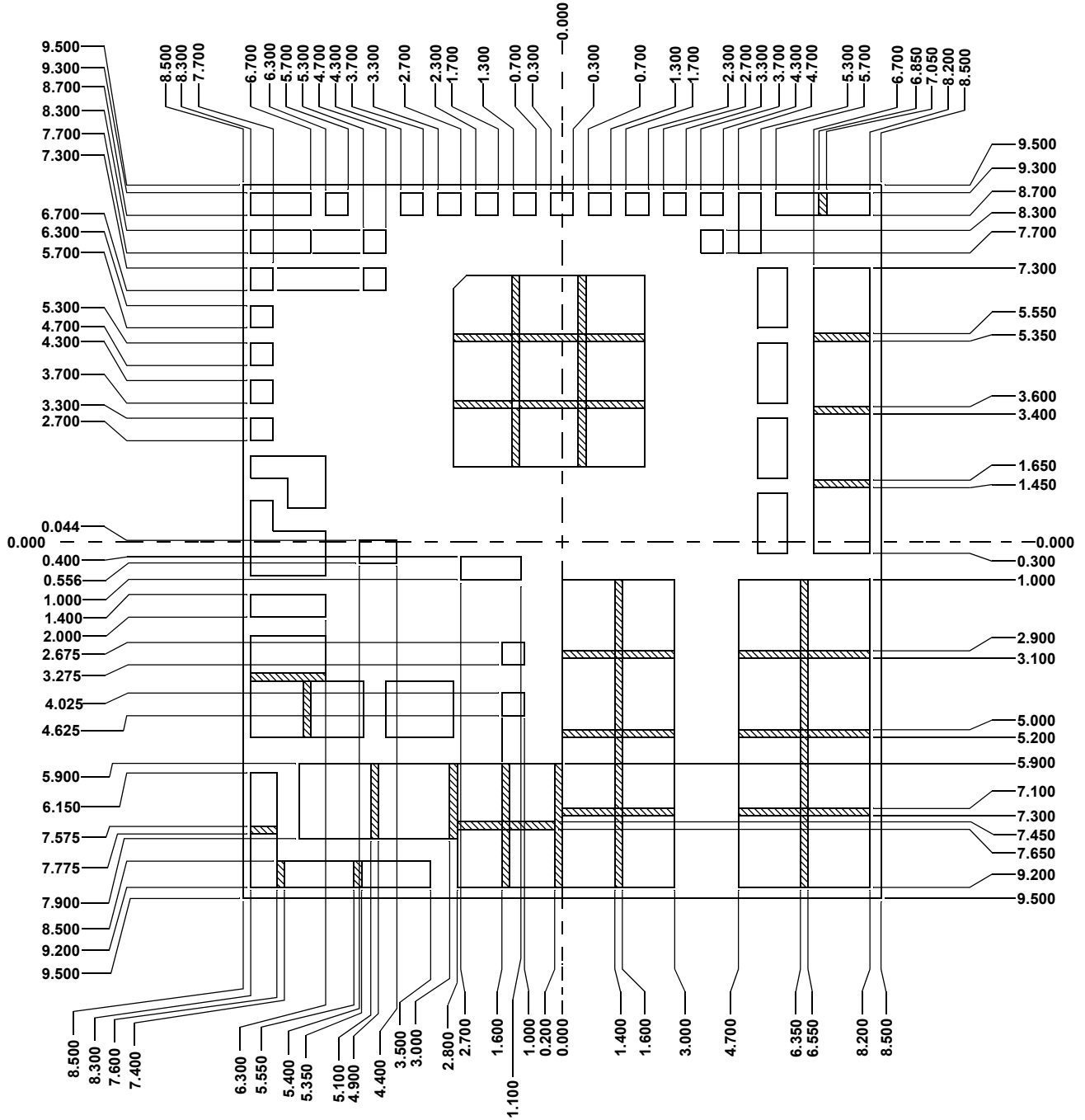

RECOMMENDED SOLDER MASK DEFINED PCB LAND PATTERN (SHEET 1 OF 2)

TOP VIEW

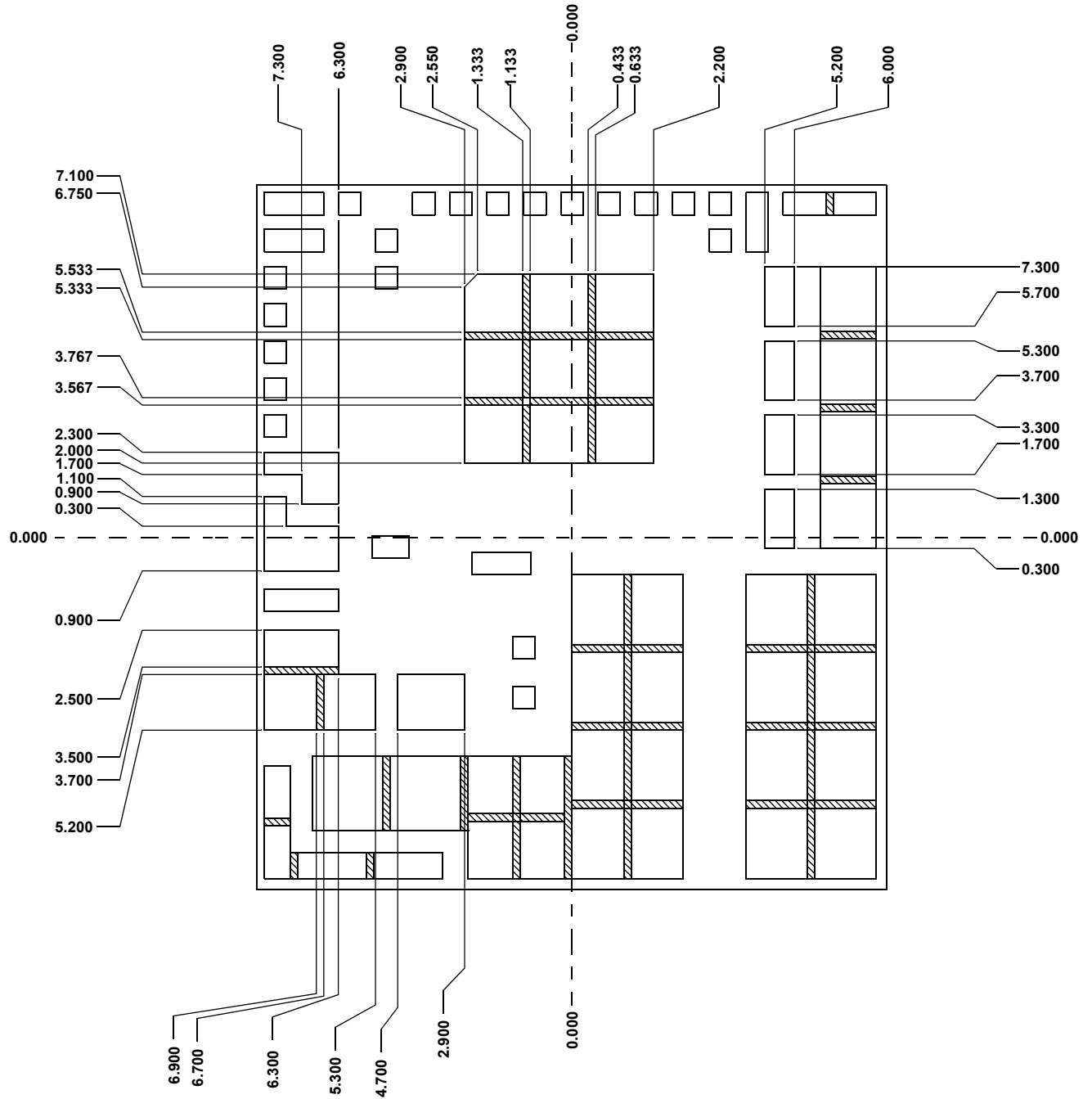

**RECOMMENDED SOLDER MASK DEFINED PCB LAND PATTERN (SHEET 2 OF 2)**

**TOP VIEW**

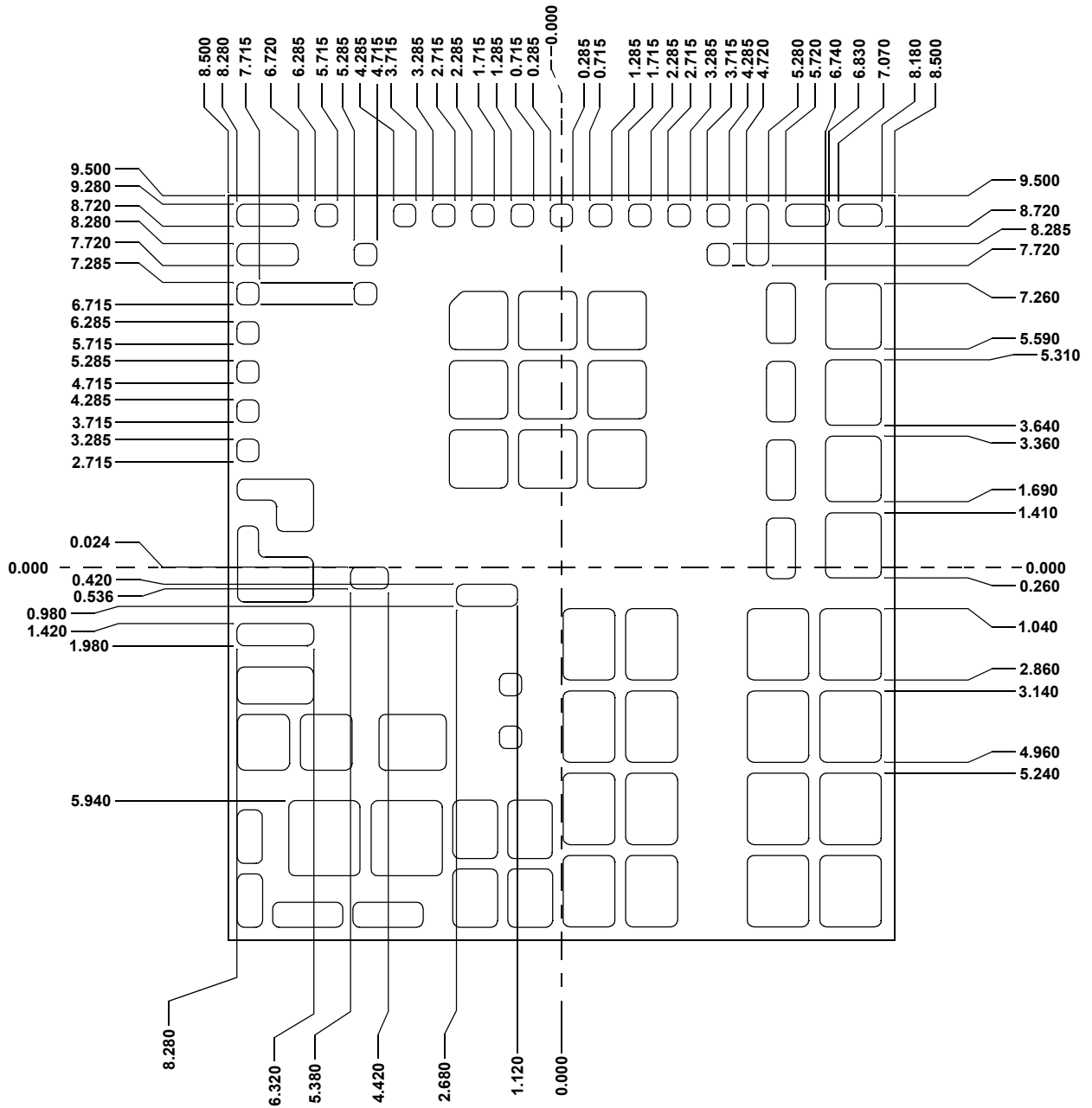

**RECOMMENDED STENCIL PATTERN (90% PASTE TO PAD) (SHEET 1 OF 2)**

**TOP VIEW**



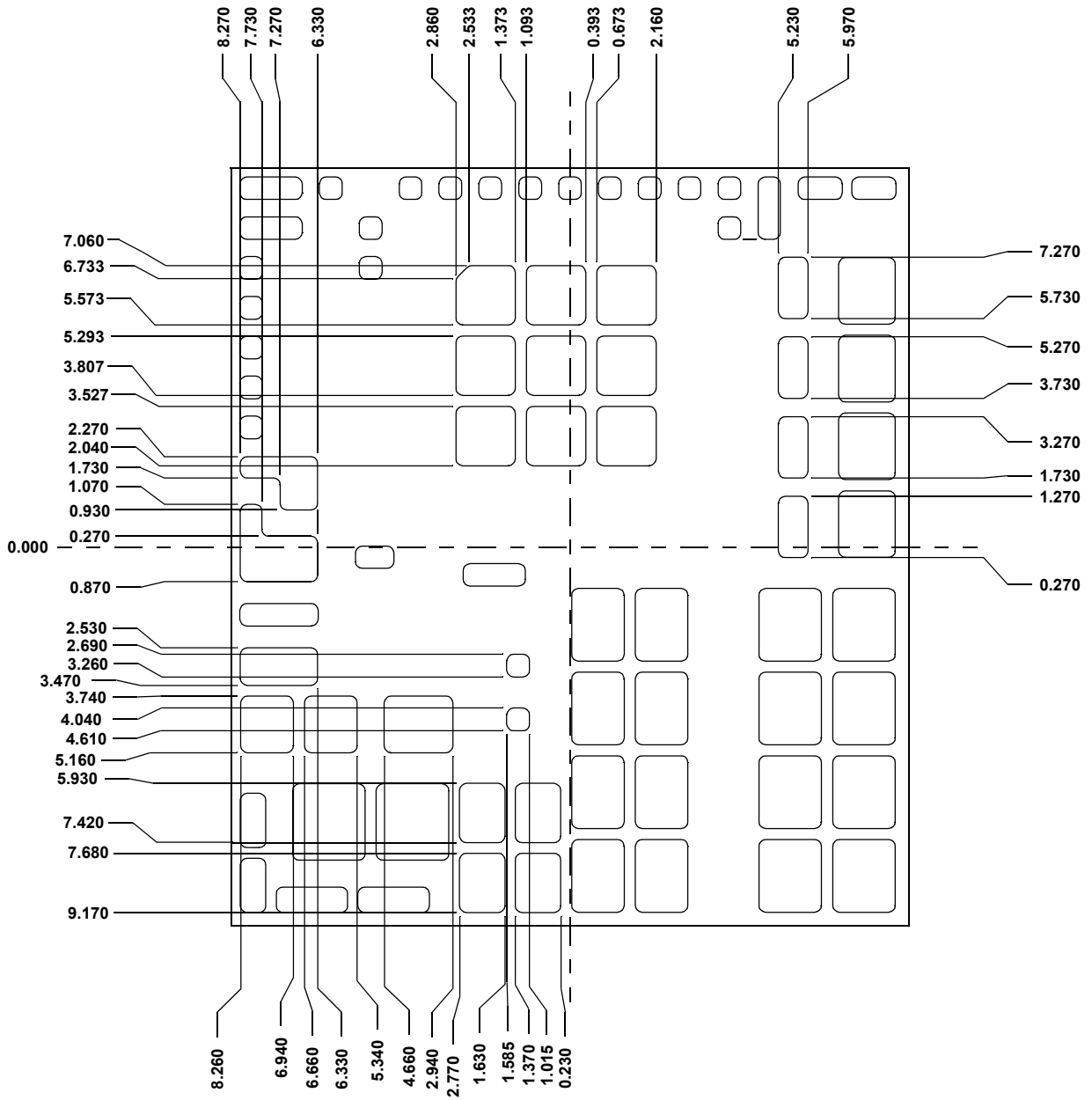

**RECOMMENDED STENCIL PATTERN (90% PASTE TO PAD) (SHEET 2 OF 2)**

**TOP VIEW**

## X-ON Electronics

Largest Supplier of Electrical and Electronic Components

*Click to view similar products for [Power Management Specialised - PMIC category](#):*

*Click to view products by [Renesas manufacturer](#):*

Other Similar products are found below :

[LV5686PVC-XH](#) [FAN7710VN](#) [NCP391FCALT2G](#) [SLG7NT4081VTR](#) [SLG7NT4192VTR](#) [AP4313UKTR-G1](#) [AS3729B-BWLM](#)  
[MB39C831QN-G-EFE2](#) [MAX4940MB](#) [LV56841PVD-XH](#) [MAX77686EWE+T](#) [AP4306BUKTR-G1](#) [MIC5164YMM](#) [PT8A3252WE](#)  
[NCP392CSFCCT1G](#) [TEA1998TS/1H](#) [PT8A3284WE](#) [PI3VST01ZEEX](#) [PI5USB1458AZAEX](#) [PI5USB1468AZAEX](#) [MCP16502TAC-E/S8B](#)  
[MCP16502TAE-E/S8B](#) [MCP16502TAA-E/S8B](#) [MCP16502TAB-E/S8B](#) [ISL91211AIKZT7AR5874](#) [ISL91211BIKZT7AR5878](#)  
[MAX17506EVKITBE#](#) [MCP16501TC-E/RMB](#) [ISL91212AIIZ-TR5770](#) [ISL91212BIIZ-TR5775](#) [CPX200D](#) [TP-1303](#) [TP-1305](#) [TP-1603](#) [TP-](#)  
[2305](#) [TP-30102](#) [TP-4503N](#) [MIC5167YML-TR](#) [LPTM21-1AFTG237C](#) [MPS-3003L-3](#) [MPS-3005D](#) [NCP392ARFCCT1G](#) [SPD-3606](#)  
[MMPF0200F6AEP](#) [STLUX383A](#) [TP-60052](#) [ADN8834ACBZ-R7](#) [LM26480SQ-AA/NOPB](#) [LM81BIMTX-3/NOPB](#) [LM81CIMT-3/NOPB](#)