

ISL8273M

80A Single Channel Digital PMBus Step-Down Power Module

FN8704  
Rev.4.00  
Nov 9, 2017

The [ISL8273M](#) is a complete PMBus enabled DC/DC single channel step-down advance power supply capable of delivering up to 80A of current and optimized for high power density applications. For higher output current, up to four ISL8273Ms can be paralleled to supply up to 320A in a multiphase current sharing configuration.

Operating over an input voltage range of 4.5V to 14V, the ISL8273M offers adjustable output voltages down to 0.6V and achieves up to 93% conversion efficiencies. A unique ChargeMode™ control architecture provides a single clock cycle response to an output load step and can support switching frequencies up to 1MHz. The power module integrates all power and most passive components and requires only a few external components to operate. A set of optional external resistors allows the user to easily configure the device for standard operation. For advanced configurations, a standard PMBus interface addresses sequencing and fault management, as well as real-time full telemetry and point-of-load monitoring. Additionally, on-board nonvolatile memory can store the desired custom configuration and settings.

A fully customizable voltage, current, and temperature protection scheme ensures safe operation for the ISL8273M under abnormal operating conditions. The device is also supported by the PowerNavigator™ software, a full digital power train development environment.

The ISL8273M is available in a low profile compact 18mmx23mmx7.5mm fully encapsulated thermally enhanced HDA package.

**Applications**

- Server, telecommunications, storage, and data communications
- Industrial/ATE and networking equipment
- General purpose power for ASIC, FPGA, DSP, and memory

**Features**

- Complete digital power supply
- 80A single channel output current
  - 4.5V to 14V single rail input voltage
  - Up to 93% efficiency
  - Up to 320A/4 parallel modules capable solution
  - Multiphase and current sharing operations (180°/22.5° steps)
- Programmable output voltage
  - 0.6V to 2.5V output voltage settings
  - ±1% accuracy over line, load, and temperature
- ChargeMode control loop architecture
  - 296kHz to 1.06MHz fixed switching frequency operations
  - No compensation required
  - Fast single clock cycle transient response
- PMBus interface and/or pin-strap mode
  - Fully programmable through PMBus
  - Pin-strap mode for standard settings
  - Real-time telemetry for  $V_{IN}$ ,  $V_{OUT}$ ,  $I_{OUT}$ , temperature, duty cycle, and  $f_{SW}$
- Advanced soft-start/stop, sequencing, and margining
- On-board nonvolatile memory
- Complete over/undervoltage, current, and temperature protections with fault logging
- [PowerNavigator](#) supported
- Thermally enhanced 18mmx23mmx7.5mm HDA package

**Related Literature**

- For a full list of related documents, visit our website
  - [ISL8273M](#) product page

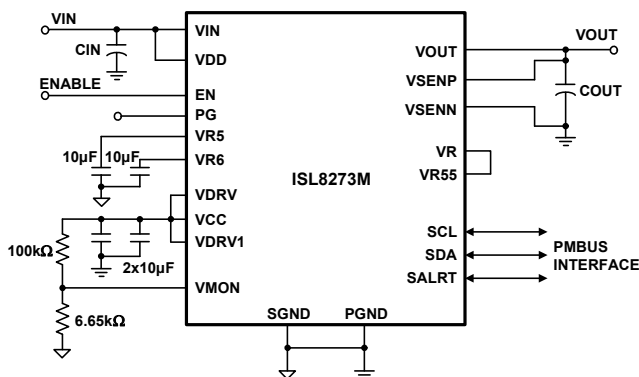

NOTE: Figure 1 represents a typical implementation of the ISL8273M. For PMBus operation, it is recommended to tie the enable pin (EN) to SGND.

FIGURE 1. 80A APPLICATION CIRCUIT

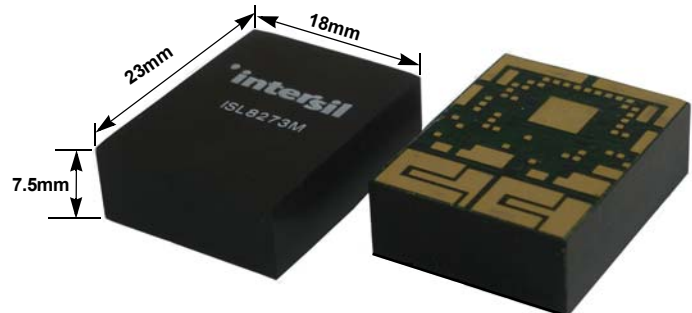

FIGURE 2. A SMALL PACKAGE FOR HIGH POWER DENSITY

# Table of Contents

<b>Ordering Information</b> .....	<b>3</b>
<b>Pin Configuration</b> .....	<b>3</b>
<b>Pin Descriptions</b> .....	<b>4</b>
<b>ISL8273M Internal Block Diagram</b> .....	<b>6</b>
<b>Typical Application Circuit - Single Module</b> .....	<b>7</b>
<b>Typical Application Circuit - Three Module Current Sharing</b> .....	<b>8</b>
<b>Absolute Maximum Ratings</b> .....	<b>10</b>
<b>Thermal Information</b> .....	<b>10</b>
<b>Recommended Operating Conditions</b> .....	<b>10</b>
<b>Electrical Specifications</b> .....	<b>10</b>
<b>Typical Performance Curves</b> .....	<b>13</b>
<b>Efficiency Performance</b> .....	<b>13</b>
<b>Transient Response Performance</b> .....	<b>14</b>
<b>Derating Curves</b> .....	<b>15</b>
<b>Functional Description</b> .....	<b>16</b>
SMBus Communications .....	16
Output Voltage Selection .....	16
Soft-Start, Stop Delay, and Ramp Times .....	16
Power-Good .....	17
Switching Frequency and PLL .....	17
Loop Compensation .....	18
Input Undervoltage Lockout (UVLO) .....	18
SMBus Module Address Selection .....	18
Output Overvoltage Protection .....	19
Output Prebias Protection .....	19
Output Overcurrent Protection .....	19
Thermal Overload Protection .....	20
Digital-DC Bus .....	20
Active Current Sharing .....	20
Phase Spreading .....	21
Fault Spreading .....	21
Output Sequencing .....	21
Monitoring with SMBus .....	22
Snapshot Parameter Capture .....	22
Nonvolatile Memory .....	22
<b>Layout Guide</b> .....	<b>22</b>
<b>Thermal Considerations</b> .....	<b>23</b>
Package Description .....	23
PCB Layout Pattern Design .....	23
Thermal Vias .....	23
Stencil Pattern Design .....	23
Reflow Parameters .....	23
<b>PMBus Command Summary</b> .....	<b>24</b>
<b>PMBus Data Formats</b> .....	<b>27</b>
<b>PMBus Use Guidelines</b> .....	<b>28</b>
Summary .....	28
<b>PMBus Commands Description</b> .....	<b>28</b>
<b>Datasheet Revision History</b> .....	<b>51</b>
<b>Firmware Revision History</b> .....	<b>52</b>
<b>About Intersil</b> .....	<b>52</b>
<b>Package Outline Drawing</b> .....	<b>53</b>

# Ordering Information

PART NUMBER (Notes 1, 2, 3)	PART MARKING	TEMP RANGE (°C)	PACKAGE (RoHS Compliant)	PKG. DWG. #
ISL8273MAIRZ	ISL8273M	-40 to +85	58 LD 18x23 HDA Module	Y58.18x23
ISL8273MCIRZ	ISL8273MC	-40 to +85	58 LD 18x23 HDA Module	Y58.18x23
ISL8273MDIRZ	ISL8273MD	-40 to +85	58 LD 18x23 HDA Module	Y58.18x23
ISL8273MEVAL1Z	Single-Module Evaluation Board (see <a href="#">UG036</a> , "ISL8273MEVAL1Z Evaluation Board User Guide")			

**NOTES:**

1. Add "-T" suffix for 100 unit tape and reel options. Refer to [TB347](#) for details about reel specifications.
2. These Pb-free plastic packaged products are RoHS compliant by EU exemption 7C-I and 7A. They employ special Pb-free material sets; molding compounds/die attach materials and NiPdAu plate-e4 termination finish, which is compatible with both SnPb and Pb-free soldering operations. Pb-free products are MSL classified at Pb-free peak reflow temperatures that meet or exceed the Pb-free requirements of IPC/JEDEC J-STD-020.
3. For Moisture Sensitivity Level (MSL), refer to the [ISL8273M](#) product information page. For more information about MSL, refer to [TB363](#).

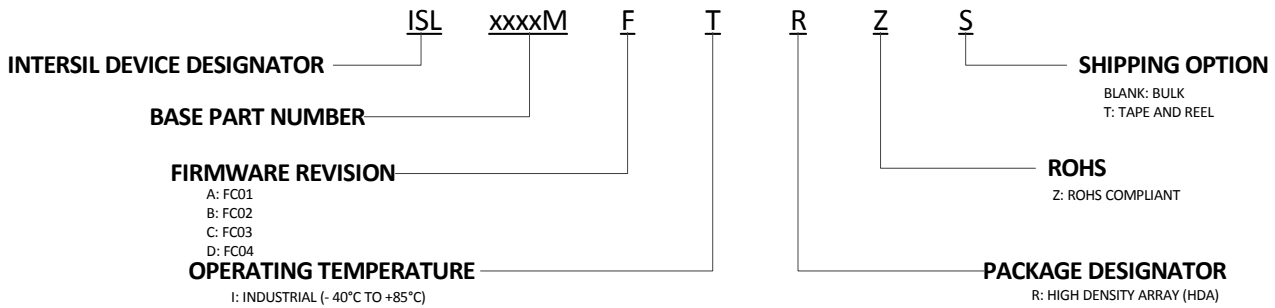

# Pin Configuration

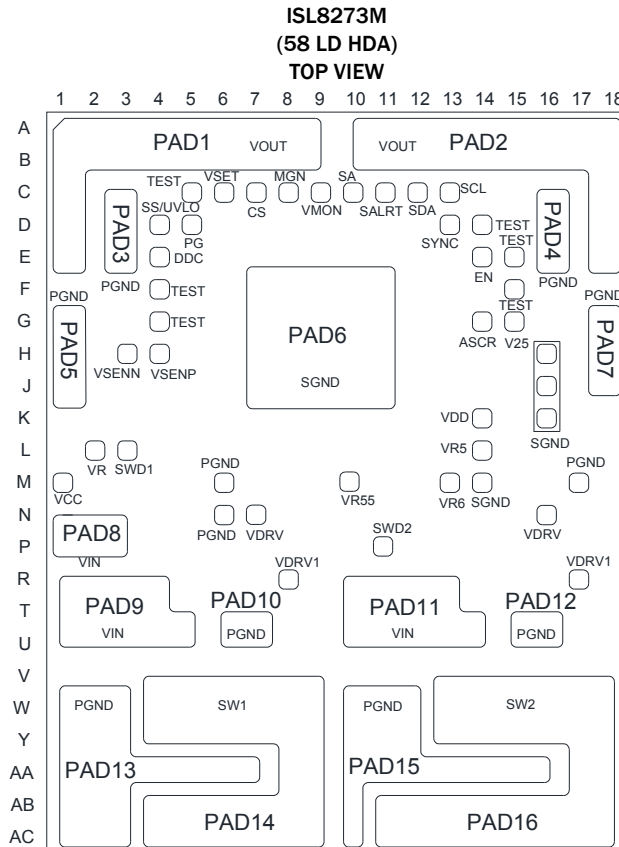

## Pin Descriptions

PIN NUMBER	PIN NAME	TYPE	DESCRIPTION
PAD1, PAD2	VOUT	PWR	Power supply output voltage. Output voltage ranges from 0.6V to 2.5V. Tie these two pins together to achieve a single output. For higher output voltage, refer to the derating curves starting on <a href="#">page 15</a> to set the maximum output current from these pads.
PAD3, PAD4, PAD5, PAD7, PAD10, PAD12, PAD13, PAD15	PGND	PWR	Power ground. Refer to the <a href="#">"Layout Guide" on page 22</a> for the PGND pad connections and I/O capacitor placement.
PAD6	SGND	PWR	Signal ground. Refer to <a href="#">"Layout Guide" on page 22</a> for the SGND pad connections.
PAD8, PAD9, PAD11	VIN	PWR	Input power supply voltage to power the module. Input voltage ranges from 4.5V to 14V.
PAD14	SW1	PWR	Switching node pads. The SW pads dissipate the heat and provide the good thermal performance. Refer to <a href="#">"Layout Guide" on page 22</a> for the SW pad connections.
PAD16	SW2		
C6	VSET	I	Output voltage selection pin. Used to set $V_{OUT}$ set point and $V_{OUT}$ max.
C7	CS	I	Current sharing configuration pin. Used to program current sharing configurations such as SYNC selection, phase spreading, and $V_{OUT}$ droop.
C8	MGN	I	External $V_{OUT}$ margin control pin. Active high (>2V) sets $V_{OUT}$ margin high; active low (<0.8V) sets $V_{OUT}$ margin low; high impedance (floating) sets $V_{OUT}$ to normal voltage. Factory default range for margining is nominal $V_{OUT} \pm 5\%$ . When using PMBus to control the margin, leave this pin as no connection.
C9	VMON	I	Driver voltage monitoring. Use this pin to monitor VDRV through an external 16:1 resistor divider.
C10	SA	I	Serial address selection pin. Used to assign a unique address for each individual device or to enable certain management features.
C11	SALRT	O	Serial alert. Connect to external host if desired. SALRT is asserted low upon a warning or a fault event and deasserted when the warning or fault is cleared. A pull-up resistor is required.
C12	SDA	I/O	Serial data. Connect to external host and/or to other Digital-DC™ devices. A pull-up resistor is required.
C13	SCL	I/O	Serial clock. Connect to external host and/or to other Digital-DC devices. A pull-up resistor is required.
D4	SS/ UVLO	I	Soft-start/stop and undervoltage lockout selection pin. Used to set turn on/off delay and ramp time as well as input UVLO threshold levels.
D5	PG	O	Power-good output. The power-good output can be an open drain that requires a pull-up resistor or a push-pull output that can drive a logic input.
D13	SYNC	I/O	Clock synchronization input. Used to set the frequency of the internal switch clock, to sync to an external clock, or to output an internal clock. If external synchronization is used, the external clock must be active before enable.
E14	EN	I	Enable pin. Set logic high to enable the module output.
E4	DDC	I/O	A Digital-DC bus. This dedicated bus provides the communication between devices for features such as sequencing, fault spreading, and current sharing. The DDC pin on all Digital-DC devices should be connected together. A pull-up resistor is required.
C5, D14, E15, F4, F15, G4	TEST	-	Test pins. Do not connect these pins.
G14	ASCR	I	ChargeMode control ASCR parameters selection pin. Used to set ASCR gain and residual values.
G15	V25	PWR	Internal 2.5V reference used to power internal circuitry. No external capacitor required for this pin. Not recommended to power external circuit.
H3	VSENN	I	Differential output voltage sense feedback. Connect to a negative output regulation point.
H4	VSENP	I	Differential output voltage sense feedback. Connect to a positive output regulation point.
H16, J16, K16, M14	SGND	PWR	Signal grounds. Use multiple vias to connect the SGND pins to the internal SGND layer.
K14	VDD	PWR	Input supply voltage for controller. Connect the VDD pad to the VIN supply.
L2	VR	PWR	Internal LDO bias pin. Tie VR to VR55 directly with a short loop trace. Not recommended to power the external circuit.

## Pin Descriptions (Continued)

PIN NUMBER	PIN NAME	TYPE	DESCRIPTION
L3	SWD1	PWR	Switching node driving pins. Directly connect to the SW1 and SW2 pads with short loop wires.
P11	SWD2		
L14	VR5	PWR	Internal 5V reference used to power internal circuitry. Place a 10 $\mu$ F decoupling capacitor for this pin. Maximum external loading current is 5mA.
M1	VCC	PWR	Internal LDO output. Connect VCC to VDRV for internal LDO driving.
M5, M17, N5	PGND	PWR	Power grounds. Use multiple vias to connect the PGND pins to the internal PGND layer.
M10	VR55	PWR	Internal 5.5V bias voltage for internal LDO use only. Tie VR55 pin directly to the VR pin. Not recommended to power external circuits.
M13	VR6	PWR	Internal 6V reference used to power internal circuitry. Place a 10 $\mu$ F decoupling capacitor for this pin. Not recommended to power external circuits.
N6, N16	VDRV	PWR	Power supply for internal FET drivers. Connect a 10 $\mu$ F bypass capacitor to each of these pins. These pins can be driven by the internal LDO through VCC pin or by the external power supply directly. Keep the driving voltage between 4.5V and 5.5V. For 5V input application, use an external supply or connect this pin to VIN.
R8, R17	VDRV1	I	Bias pin of the internal FET drivers. Always tie to VDRV.

# ISL8273M Internal Block Diagram

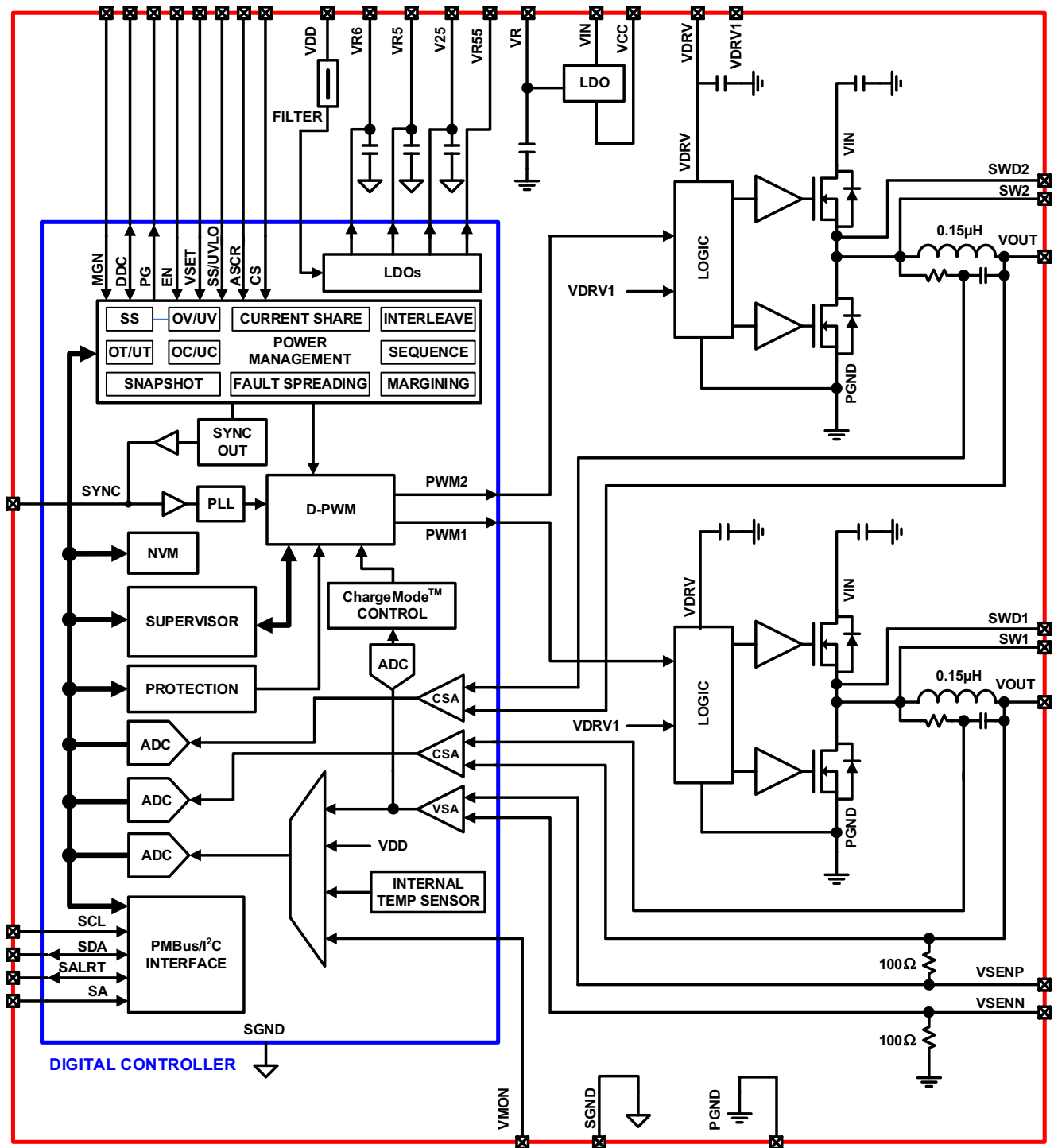
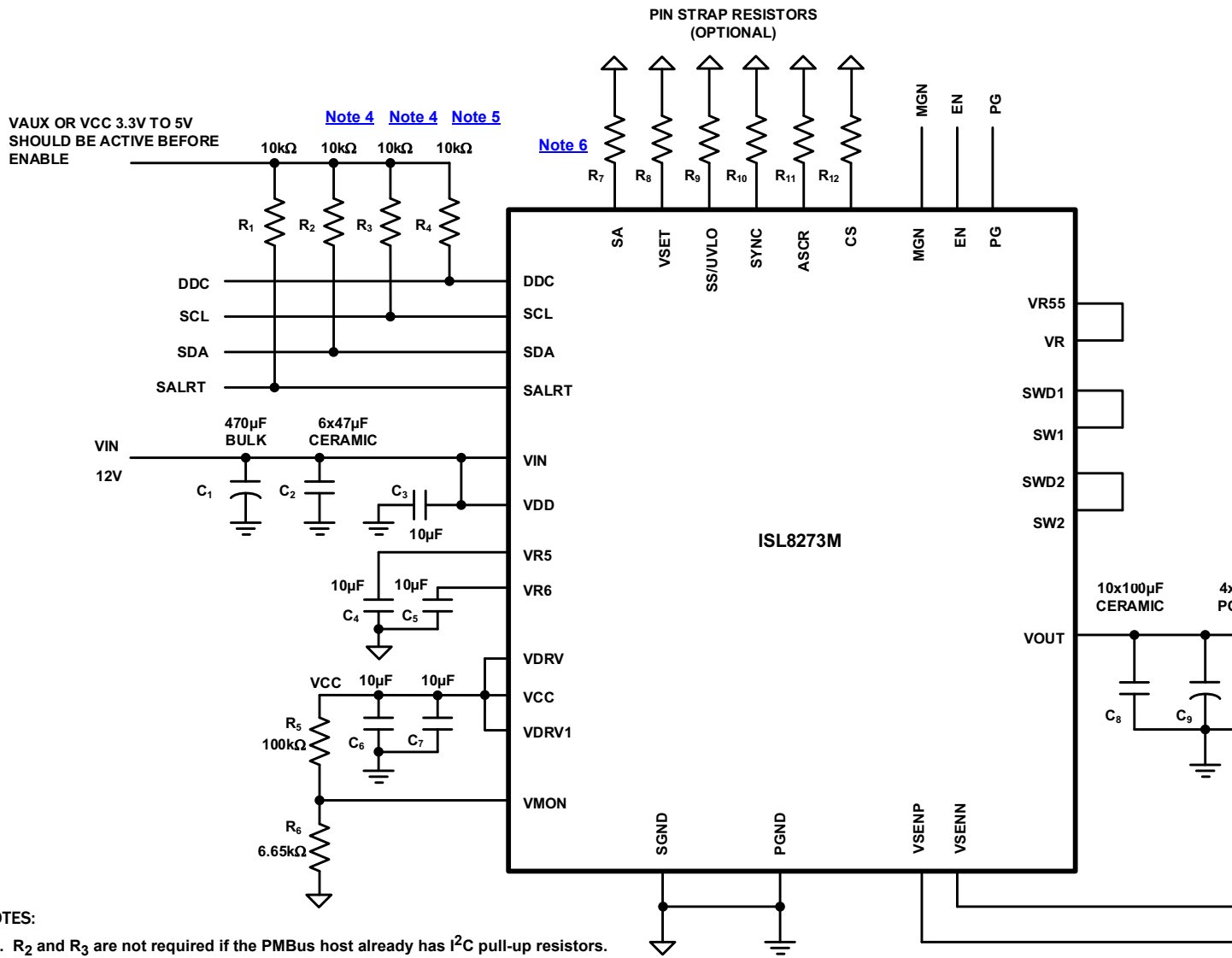

FIGURE 3. INTERNAL BLOCK DIAGRAM

## Typical Application Circuit - Single Module



NOTES:

- R<sub>2</sub> and R<sub>3</sub> are not required if the PMBus host already has I<sup>2</sup>C pull-up resistors.
- Only one R<sub>4</sub> per DDC bus is required when multiple modules share the same DDC bus.
- R<sub>7</sub> through R<sub>12</sub> can be selected according to the tables for the pin-strap resistor setting in this document. If the PMBus configuration is chosen to overwrite the pin-strap configuration, R<sub>8</sub> through R<sub>12</sub> can be non-populated.
- V<sub>25</sub>, VR and VR55 do not need external capacitors. V<sub>25</sub> can be no connection.

FIGURE 4. TYPICAL APPLICATION CIRCUIT - SINGLE MODULE

# Typical Application Circuit - Three Module Current Sharing

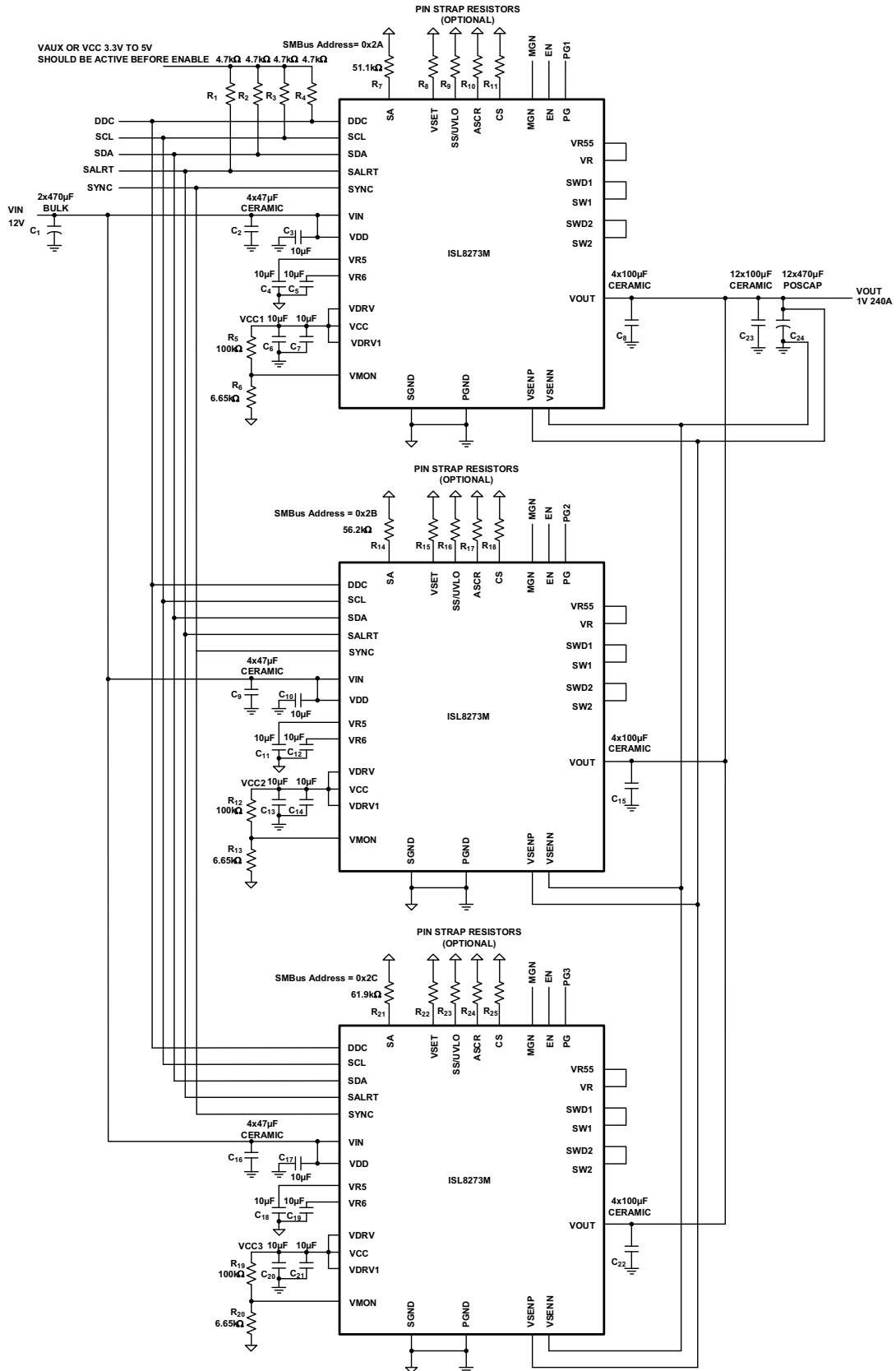

FIGURE 5. TYPICAL APPLICATION CIRCUIT - THREE MODULE CURRENT SHARING



TABLE 1. ISL8273M DESIGN GUIDE MATRIX AND OUTPUT VOLTAGE RESPONSE

V <sub>IN</sub> (V)	V <sub>OUT</sub> (V)	C <sub>IN</sub> (BULK) (μF) (Note 8)	C <sub>IN</sub> (CERAMIC) (μF)	C <sub>OUT</sub> (BULK) (μF)	C <sub>OUT</sub> (CERAMIC) (μF)	ASCR GAIN (Note 9)	ASCR RESIDUAL (Note 9)	V <sub>OUT</sub> DEVIATION (mV)	RECOVERY TIME (μs)	LOAD STEP (A) (Note 10)	FREQ. (kHz)
5	1	1x470	6x47	6x470	12x100	100	90	80	25	0 to 40	300
5	1	1x470	4x47	4x470	8x100	220	90	95	20	0 to 40	571
5	1.5	1x470	6x47	6x470	14x100	110	90	82	35	0 to 40	300
5	1.5	1x470	4x47	4x470	10x100	240	90	85	20	0 to 40	571
12	1	1x470	8x47	6x470	14x100	140	90	80	30	0 to 40	300
12	1	1x470	6x47	4x470	10x100	240	90	82	20	0 to 40	571
12	1.5	1x470	8x47	6x470	12x100	140	90	85	35	0 to 40	364
12	1.5	1x470	6x47	4x470	10x100	220	90	85	30	0 to 40	571
12	2.5	1x470	8x47	4x470	8x100	180	90	105	45	0 to 40	571
12	2.5	1x470	6x47	3x470	6x100	220	90	110	40	0 to 40	800

## NOTES:

8. C<sub>IN</sub> bulk capacitor is optional only for energy buffer from the long input power supply cable.
9. ASCR gain and residual are selected to ensure phase margin higher than 60° and gain margin higher than 6dB at ambient room temperature and full load (80A).
10. Output voltage response is tested with load step slew rate higher than 100A/μs.

TABLE 2. RECOMMENDED INPUT/OUTPUT CAPACITOR

VENDORS	VALUE	PART NUMBER
MURATA, Input Ceramic	47μF, 16V, 1210	GRM32ER61C476ME15L
MURATA, Input Ceramic	22μF, 16V, 1210	GRM32ER61E226KE15L
TAIYO YUDEN, Input Ceramic	47μF, 16V, 1210	EMK325BJ476MM-T
TAIYO YUDEN, Input Ceramic	22μF, 25V, 1210	TMK325BJ226MM-T
MURATA, Output Ceramic	100μF, 6.3V, 1210	GRM32ER60J107M
TDK, Output Ceramic	100μF, 6.3V, 1210	C3225X5R0J107M
AVX, Output Ceramic	100μF, 6.3V, 1210	12106D107MAT2A
SANYO POSCAP, Output Bulk	470μF, 4V	4TPE470MCL
SANYO POSCAP, Output Bulk	470μF, 6.3V	6TPF470MAH
PANASONIC, Input Bulk	150μF, 16V	16TQC150MYF

**Absolute Maximum Ratings**

Input Supply Voltage, VIN Pin	-0.3V to 17V
Input Supply Voltage for Controller, VDD Pin	-0.3V to 17V
MOSFET Switch Node Voltage, SW1/2, SWD1/2	-0.3V to 17V
MOSFET Driver Supply Voltage, VDRV, VDRV1 Pin	-0.3V to 6.0V
Output Voltage, VOUT pin	-0.3V to 6.0V
Internal Reference Supply Voltage, VR6 Pin	-0.3V to 6.6V
Internal Reference Supply Voltage, VR, VR5, VR55 Pin	-0.3V to 6.5V
Internal Reference Supply Voltage, V25 Pin	-0.3V to 3V
Logic I/O Voltage for DDC, EN, MGN, PG, ASCR, CS SA, SCL, SDA, SALRT, SYNC, SS/UVLO, VMON, VSET	-0.3V to 6.0V
Analog Input Voltages	
VSENP	-0.3V to 6.0V
VSENN	-0.3V to 0.3V
ESD Rating	
Human Body Model (Tested per JESD22-A114F)	2kV
Machine Model (Tested per JESD22-A115C)	200V
Charged Device Model (Tested per JESD22-C110D)	750V
Latch-up (Tested per JESD78C; Class 2, Level A)	100mA

**Thermal Information**

Thermal Resistance (Typical)	$\theta_{JA}$ (°C/W)	$\theta_{JC}$ (°C/W)
58 LD HDA Package (Notes 11, 12)	5.3	1.1
Maximum Junction Temperature (Plastic Package)	+125°C	
Storage Temperature Range	-55°C to +150°C	
Pb-free Reflow Profile	see Figure 28	

**Recommended Operating Conditions**

Input Supply Voltage Range, VIN	4.5V to 14V
Input Supply Voltage Range for Controller, VDD	4.5V to 14V
Output Voltage Range, VOUT	0.6V to 2.5V
Output Current Range, IOUT(DC) (Note 15)	0A to 80A
Operating Junction Temperature Range, TJ	-40°C to +125°C

CAUTION: Do not operate at or near the maximum ratings listed for extended periods of time. Exposure to such conditions may adversely impact product reliability and result in failures not covered by warranty.

NOTES:

- $\theta_{JA}$  is measured in free air with the module mounted on an 8-layer evaluation board 4.7x4.8inch in size with 2oz Cu on all layers and multiple via interconnects as specified in the ISL8273MEVAL1Z evaluation board user guide.
- For  $\theta_{JC}$ , the “case temp” location is the center of the package underside.

**Electrical Specifications**

VIN = VDD = 12V, fSW = 533kHz, TA = -40°C to +85°C, unless otherwise noted. Typical values are at TA = +25°C. Boldface limits apply across the operating temperature range, -40°C to +85°C.

PARAMETER	SYMBOL	TEST CONDITIONS	MIN (Note 13)	TYP	MAX (Note 13)	UNIT
<b>INPUT AND SUPPLY CHARACTERISTICS</b>						
Input Supply Current for Controller	IDD	VIN = VDD = 12V, VOUT = 0V, module not enabled		40	<b>50</b>	mA
6V Internal Reference Supply Voltage	VR6		<b>5.5</b>	6.1	<b>6.6</b>	V
5V Internal Reference Supply	VR5	IvR5 <5mA	<b>4.5</b>	5.2	<b>5.5</b>	V
2.5V Internal Reference Supply	V25		<b>2.25</b>	2.5	<b>2.75</b>	V
Internal LDO Output Voltage	Vcc			5.3		V
Internal LDO Output Current	IvCC	VIN = VDD = 12V, VCC connected to VDRV, module enabled	<b>50</b>			mA
Input Supply Voltage for Controller Read Back Resolution	VDD_READ_RES			±20		mV
Input Supply Voltage for Controller Read Back Total Error (Note 16)	VDD_READ_ERR	PMBus Read		±2		% FS
<b>OUTPUT CHARACTERISTICS</b>						
Output Voltage Adjustment Range	VOUT_RANGE	VIN > VOUT + 1.8V	<b>0.54</b>		<b>2.75</b>	V
Output Voltage Set-Point Range	VOUT_RES	Configured using PMBus		±0.025		%
Output Voltage Set-Point Accuracy (Notes 14, 16)	VOUT_ACCY	Includes line, load, and temperature (-20°C ≤ TA ≤ +85°C)	<b>-1</b>		<b>+1</b>	% FS
Output Voltage Read Back Resolution	VOUT_READ_RES			±0.15		% FS
Output Voltage Read Back Total Error (Note 16)	VOUT_READ_ERR	PMBus read	<b>-2</b>		<b>+2</b>	% FS
Output Ripple Voltage	VOUT_RIPPLE	VOUT = 1V, COUT = 6 x 470µF POSCAP + 12 x 100µF CERAMIC		8		mV

**Electrical Specifications**  $V_{IN} = V_{DD} = 12V$ ,  $f_{SW} = 533kHz$ ,  $T_A = -40^{\circ}C$  to  $+85^{\circ}C$ , unless otherwise noted. Typical values are at  $T_A = +25^{\circ}C$ . **Boldface limits apply across the operating temperature range,  $-40^{\circ}C$  to  $+85^{\circ}C$ .** (Continued)

PARAMETER	SYMBOL	TEST CONDITIONS	MIN (Note 13)	TYP	MAX (Note 13)	UNIT
Output Current Read Back Resolution	$I_{OUT\_READ\_RES}$			0.087		A
Output Current Range (Note 15)	$I_{OUT\_RANGE}$				<b>80</b>	A
Output Current Read Back Total Error	$I_{OUT\_READ\_ERR}$	PMBus read at max load. $V_{OUT} = 1V$		$\pm 3$		A
<b>SOFT-START AND SEQUENCING</b>						
Delay Time from Enable to $V_{OUT}$ Rise	$t_{ON\_DELAY}$	Configured using PMBus	<b>2</b>		<b>5000</b>	ms
$t_{ON\_DELAY}$ Accuracy	$t_{ON\_DELAY\_ACCY}$			$\pm 2$		ms
Output Voltage Ramp-Up Time	$t_{ON\_RISE}$	Configured using PMBus. Single module standalone	<b>0.5</b>		<b>100</b>	ms
Output Voltage Ramp-Up Time Accuracy	$t_{ON\_RISE\_ACCY}$	Single module standalone		$\pm 250$		$\mu s$
Delay Time from Disable to $V_{OUT}$ Fall	$t_{OFF\_DELAY}$	Configured using PMBus	<b>2</b>		<b>5000</b>	ms
$t_{OFF\_DELAY}$ Accuracy	$t_{OFF\_DELAY\_ACCY}$			$\pm 2$		ms
Output Voltage Fall Time	$t_{OFF\_FALL}$	Configured using PMBus. Single module standalone	<b>0.5</b>		<b>100</b>	ms
Output Voltage Fall Time Accuracy	$t_{ON\_FALL\_ACCY}$	Single module standalone		$\pm 250$		$\mu s$
<b>POWER-GOOD</b>						
Power-Good Delay	$V_{PG\_DELAY}$	Configured using PMBus	<b>0</b>		<b>5000</b>	ms
<b>TEMPERATURE SENSE</b>						
Temperature Sense Range	$T_{SENSE\_RANGE}$	Configurable using PMBus	<b>-50</b>		<b>150</b>	$^{\circ}C$
Internal Temperature Sensor Accuracy	$INT\_TEMP\_ACCY$	Tested at $+100^{\circ}C$	-5		+5	$^{\circ}C$
<b>FAULT PROTECTION</b>						
$V_{DD}$ Undervoltage Threshold Range	$V_{DD\_UVLO\_RANGE}$	Measured internally	<b>4.18</b>		<b>16</b>	V
$V_{DD}$ Undervoltage Threshold Accuracy (Note 16)	$V_{DD\_UVLO\_ACCY}$			$\pm 2$		%FS
$V_{DD}$ Undervoltage Response Time	$V_{DD\_UVLO\_DELAY}$			10		$\mu s$
$V_{OUT}$ Overvoltage Threshold Range	$V_{OUT\_OV\_RANGE}$	Factory default		$1.15V_{OUT}$		V
		Configured using PMBus	<b><math>1.05V_{OUT}</math></b>		<b><math>V_{OUT\_MAX}</math></b>	V
$V_{OUT}$ Undervoltage Threshold Range	$V_{OUT\_UV\_RANGE}$	Factory default		$0.85V_{OUT}$		V
		Configured using PMBus	<b>0</b>		<b><math>0.95V_{OUT}</math></b>	V
$V_{OUT}$ OV/UV Threshold Accuracy (Note 14)	$V_{OUT\_OV/UV\_ACCY}$		<b>-2</b>		<b>+2</b>	%
$V_{OUT}$ OV/UV Response Time	$V_{OUT\_OV/UV\_DELAY}$			10		$\mu s$
Output Current Limit Set-Point Accuracy (Note 16)	$I_{LIMIT\_ACCY}$	Tested at $I_{OUT\_OC\_FAULT\_LIMIT} = 80A$		$\pm 10$		% FS
Output Current Fault Response Time	$I_{LIMIT\_DELAY}$	Factory default		3		$t_{SW}$ (Note 17)
Over-temperature Protection Threshold (Controller Junction Temperature)	$T_{JUNCTION}$	Factory default		125		$^{\circ}C$
		Configured using PMBus	<b>-40</b>		<b>125</b>	$^{\circ}C$
Thermal Protection Hysteresis	$T_{JUNCTION\_HYS}$			15		$^{\circ}C$

**Electrical Specifications**  $V_{IN} = V_{DD} = 12V$ ,  $f_{SW} = 533kHz$ ,  $T_A = -40^\circ C$  to  $+85^\circ C$ , unless otherwise noted. Typical values are at  $T_A = +25^\circ C$ . **Boldface limits apply across the operating temperature range,  $-40^\circ C$  to  $+85^\circ C$ .** (Continued)

PARAMETER	SYMBOL	TEST CONDITIONS	MIN (Note 13)	TYP	MAX (Note 13)	UNIT
<b>OSCILLATOR AND SWITCHING CHARACTERISTICS</b>						
Switching Frequency Range	$f_{SW\_RANGE}$		<b>296</b>		<b>1067</b>	kHz
Switching Frequency Set-Point Accuracy	$f_{SW\_ACCY}$		<b>-5</b>		<b>+5</b>	%
Minimum Pulse Width Required from External SYNC Clock	$EXT\_SYNC_{PW}$	Measured at 50% Amplitude	<b>150</b>			ns
Drift Tolerance for External SYNC Clock	$EXT\_SYNC_{DRIFT}$	External SYNC Clock equal to 500kHz is not supported	<b>-10</b>		<b>+10</b>	%
<b>LOGIC INPUT/OUTPUT CHARACTERISTICS</b>						
Bias Current at the Logic Input Pins	$I_{LOGIC\_BIAS}$	DDC, EN, MGN, PG, SA, SCL, SDA, SALRT, SYNC, UVLO, $V_{MON}$ , $V_{SET}$	<b>-100</b>		<b>+100</b>	nA
Logic Input Low Threshold Voltage	$V_{LOGIC\_IN\_LOW}$				<b>0.8</b>	V
Logic Input High Threshold Voltage	$V_{LOGIC\_IN\_HIGH}$		<b>2.0</b>			V
Logic Output Low Threshold Voltage	$V_{LOGIC\_OUT\_LOW}$	2mA sinking			<b>0.5</b>	V
Logic Output High Threshold Voltage	$V_{LOGIC\_OUT\_HIGH}$	2mA sourcing	<b>2.25</b>			V
<b>PMBus INTERFACE TIMING CHARACTERISTIC</b>						
PMBus Operating Frequency	$f_{SMB}$		<b>100</b>		<b>400</b>	kHz

## NOTES:

13. Compliance to datasheet limits is assured by one or more methods: Production test, characterization, and/or design. Controller is independently tested before module assembly.
14.  $V_{OUT}$  measured at the termination of the VSENP and VSENN sense points.
15. The MAX load current is determined by the thermal ["Derating Curves" on page 15](#).
16. "FS" stands for full scale of recommended maximum operation range.
17. " $t_{SW}$ " stands for time period of operation switching frequency.

# Typical Performance Curves

**Efficiency Performance** Operating condition:  $T_A = +25^\circ\text{C}$ , no air flow.  $C_{OUT} = 6 \times 470\mu\text{F POSCAP} + 12 \times 100\mu\text{F CERAMIC}$ . Typical values are used unless otherwise noted.

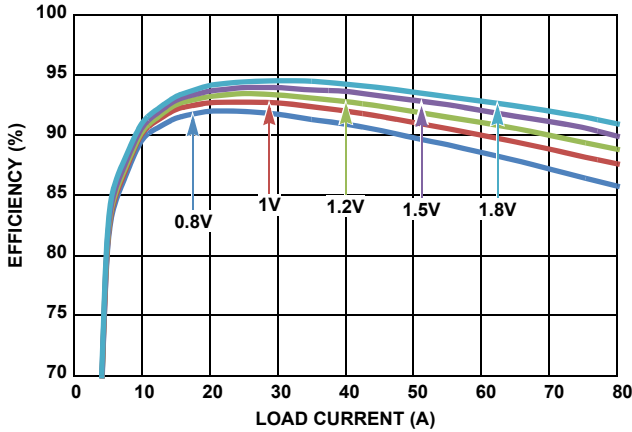

FIGURE 6. EFFICIENCY vs OUTPUT CURRENT AT  $V_{IN} = 5\text{V}$ ,  $f_{SW} = 300\text{kHz}$  FOR VARIOUS OUTPUT VOLTAGES

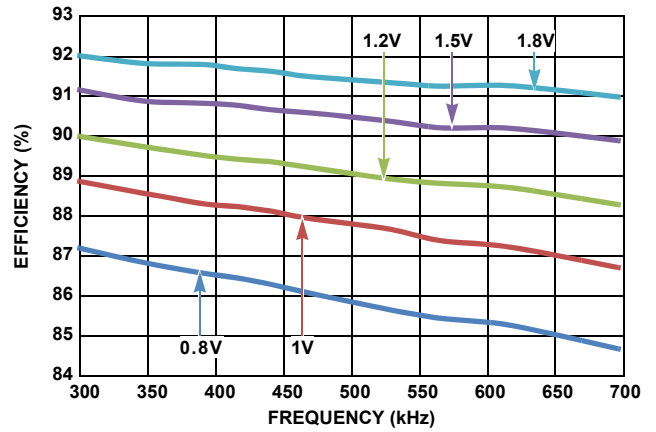

FIGURE 7. EFFICIENCY vs SWITCHING FREQUENCY AT  $V_{IN} = 5\text{V}$ ,  $I_{OUT} = 70\text{A}$  FOR VARIOUS OUTPUT VOLTAGES

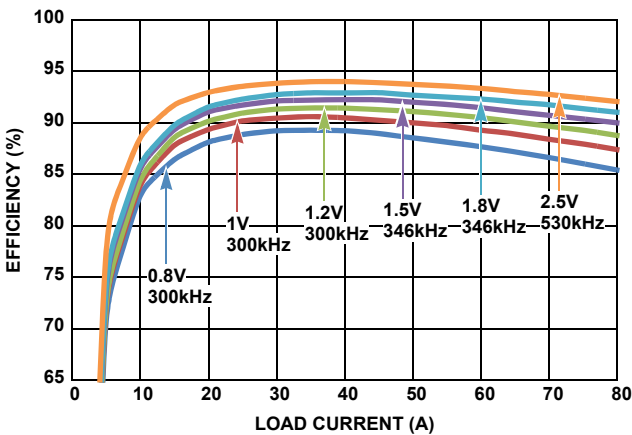

FIGURE 8. EFFICIENCY vs OUTPUT CURRENT AT  $V_{IN} = 9\text{V}$ , FOR VARIOUS OUTPUT VOLTAGES

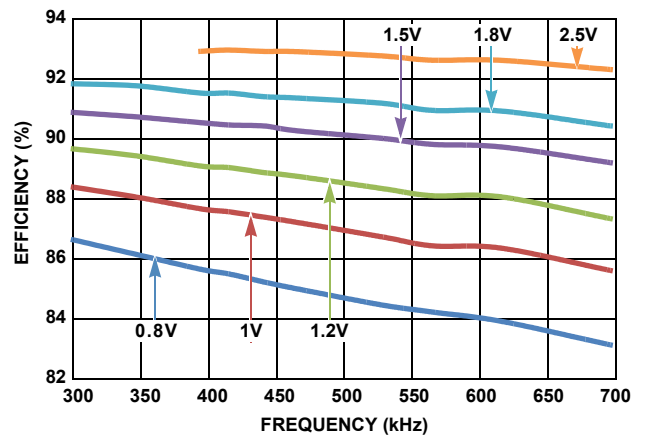

FIGURE 9. EFFICIENCY vs SWITCHING FREQUENCY AT  $V_{IN} = 9\text{V}$ ,  $I_{OUT} = 70\text{A}$  FOR VARIOUS OUTPUT VOLTAGES

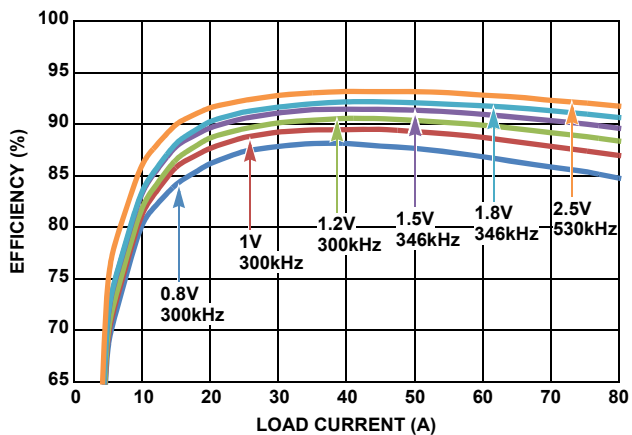

FIGURE 10. EFFICIENCY vs OUTPUT CURRENT AT  $V_{IN} = 12\text{V}$ , FOR VARIOUS OUTPUT VOLTAGES

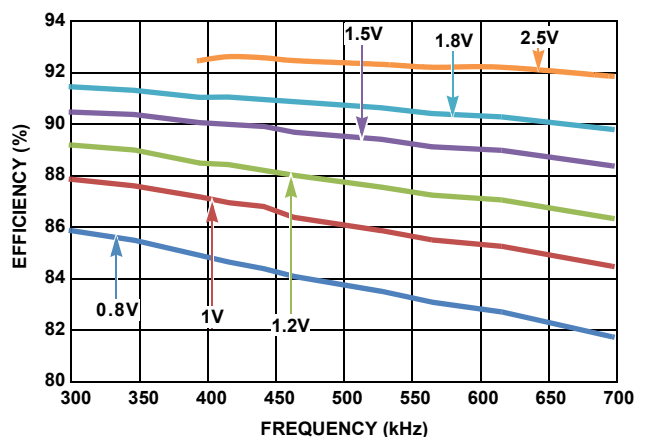

FIGURE 11. EFFICIENCY vs SWITCHING FREQUENCY AT  $V_{IN} = 12\text{V}$ ,  $I_{OUT} = 70\text{A}$  FOR VARIOUS OUTPUT VOLTAGES

## Typical Performance Curves (Continued)

**Transient Response Performance** Operating conditions:  $I_{OUT} = 0A/40A$ ,  $I_{OUT}$  slew rate  $> 100A/\mu s$ ,  $T_A = +25^\circ C$ , 0LFM. Typical values are used unless otherwise noted.

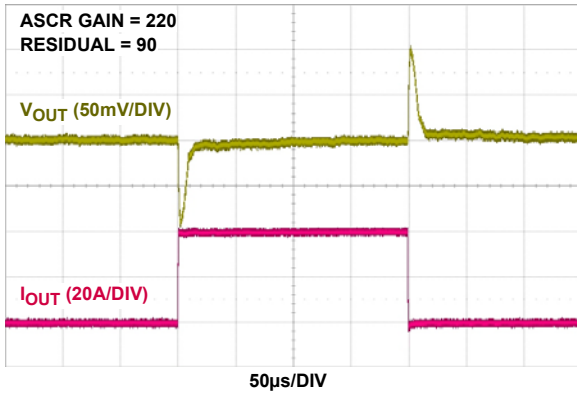

FIGURE 12. 5V<sub>IN</sub> TO 1V<sub>OUT</sub> TRANSIENT RESPONSE,  $f_{SW} = 571kHz$ ,  $C_{OUT} = 8 \times 100\mu F$  CERAMIC + 4x470µF POSCAP

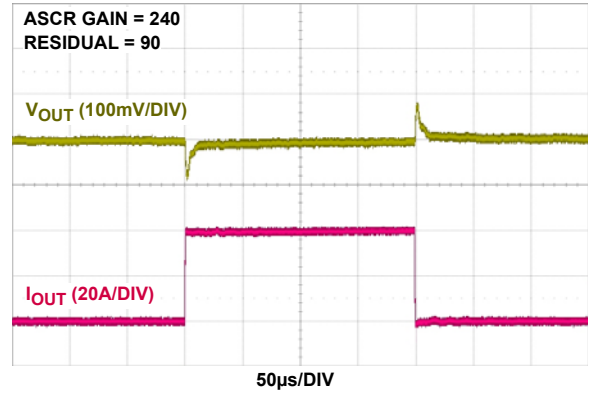

FIGURE 13. 5V<sub>IN</sub> TO 1.5V<sub>OUT</sub> TRANSIENT RESPONSE,  $f_{SW} = 571kHz$ ,  $C_{OUT} = 10 \times 100\mu F$  CERAMIC + 4x470µF POSCAP

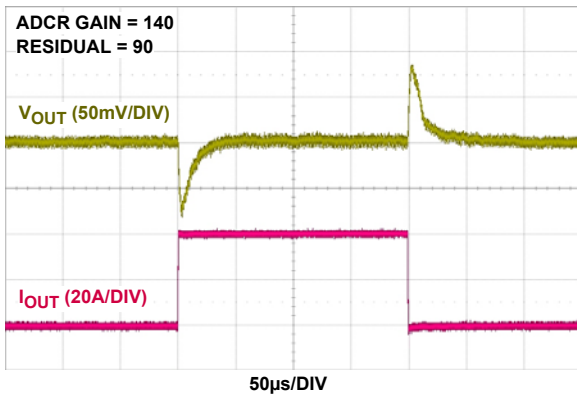

FIGURE 14. 12V<sub>IN</sub> TO 1V<sub>OUT</sub> TRANSIENT RESPONSE,  $f_{SW} = 300kHz$ ,  $C_{OUT} = 14 \times 100\mu F$  CERAMIC + 6x470µF POSCAP

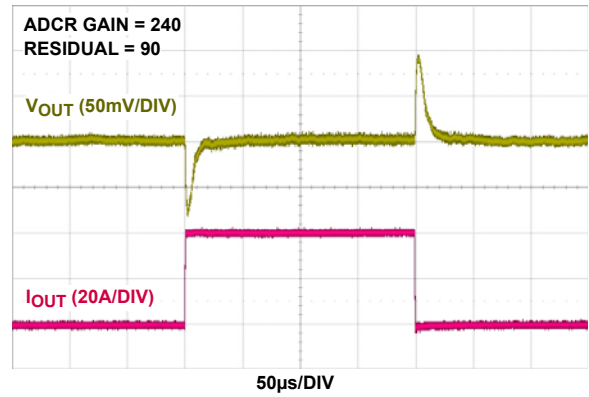

FIGURE 15. 12V<sub>IN</sub> TO 1V<sub>OUT</sub> TRANSIENT RESPONSE,  $f_{SW} = 571kHz$ ,  $C_{OUT} = 10 \times 100\mu F$  CERAMIC + 4x470µF POSCAP

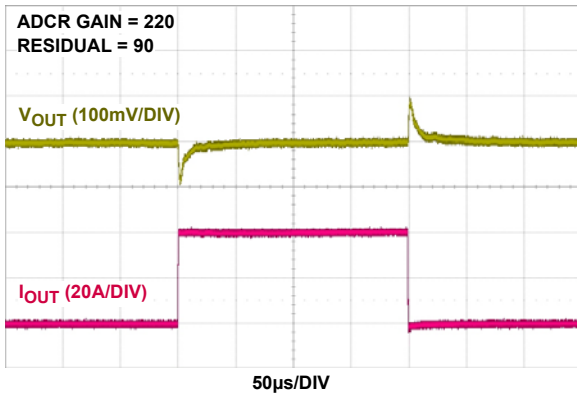

FIGURE 16. 12V<sub>IN</sub> TO 1.5V<sub>OUT</sub> TRANSIENT RESPONSE,  $f_{SW} = 571kHz$ ,  $C_{OUT} = 10 \times 100\mu F$  CERAMIC + 4x470µF POSCAP

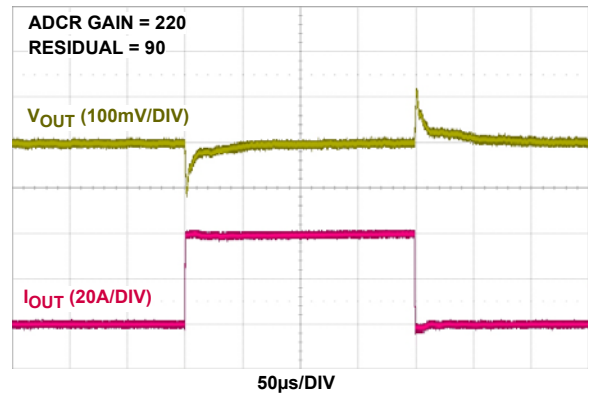

FIGURE 17. 12V<sub>IN</sub> TO 2.5V<sub>OUT</sub> TRANSIENT RESPONSE,  $f_{SW} = 800kHz$ ,  $C_{OUT} = 6 \times 100\mu F$  CERAMIC + 3x470µF POSCAP

## Typical Performance Curves (Continued)

**Derating Curves** All of the following curves were plotted at  $T_j = +120^\circ\text{C}$ .

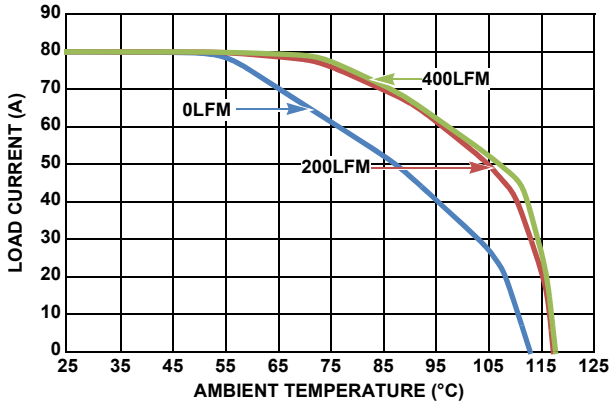

FIGURE 18.  $5V_{IN}$  TO  $1V_{OUT}$ ,  $f_{SW} = 300\text{kHz}$

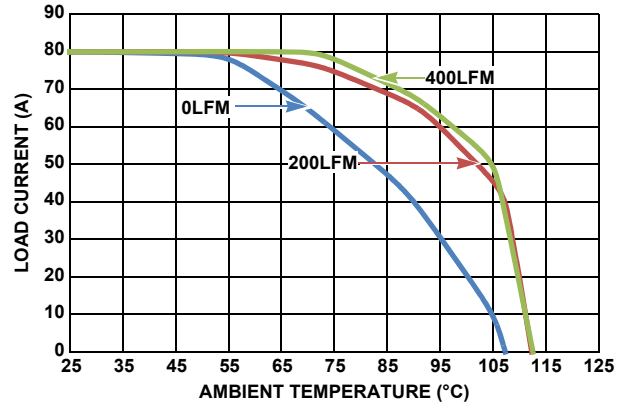

FIGURE 19.  $12V_{IN}$  TO  $1V_{OUT}$ ,  $f_{SW} = 300\text{kHz}$

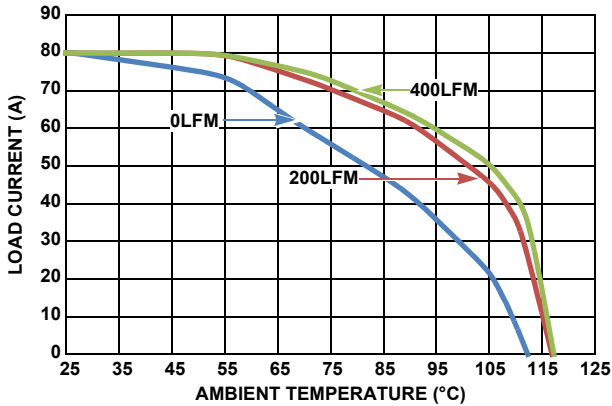

FIGURE 20.  $5V_{IN}$  TO  $1.5V_{OUT}$ ,  $f_{SW} = 300\text{kHz}$

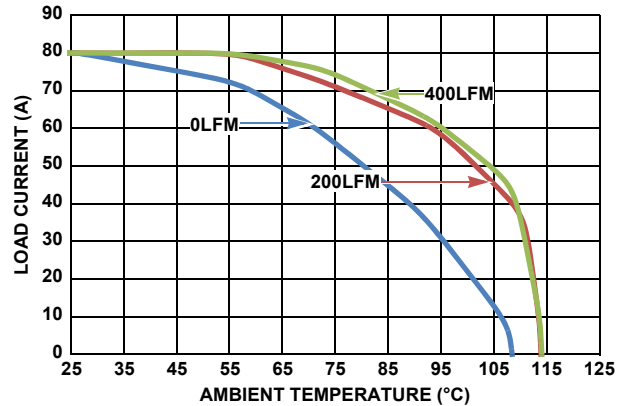

FIGURE 21.  $12V_{IN}$  TO  $1.5V_{OUT}$ ,  $f_{SW} = 364\text{kHz}$

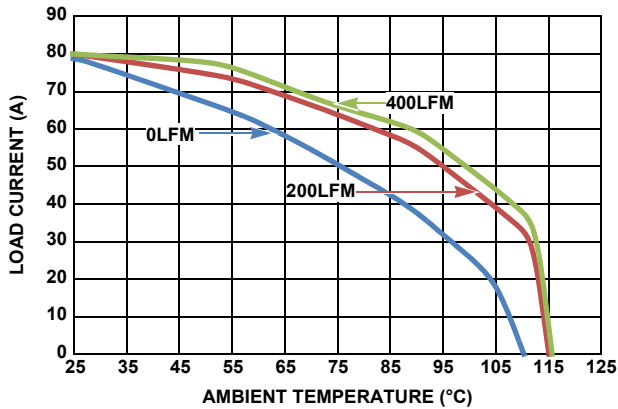

FIGURE 22.  $5V_{IN}$  TO  $2.5V_{OUT}$ ,  $f_{SW} = 364\text{kHz}$

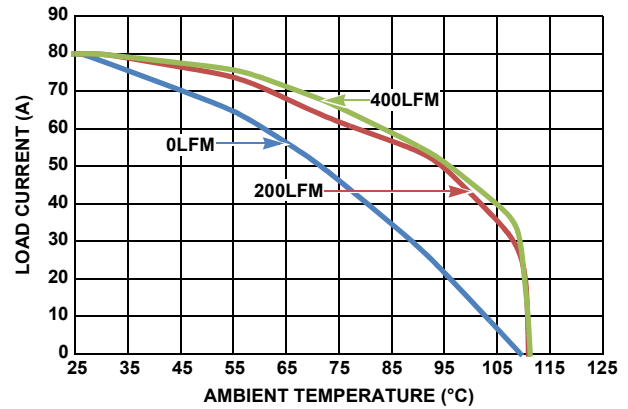

FIGURE 23.  $12V_{IN}$  TO  $2.5V_{OUT}$ ,  $f_{SW} = 533\text{kHz}$

## Functional Description

### SMBus Communications

The ISL8273M provides a PMBus digital interface that enables the user to configure all aspects of the module operation as well as monitor the input and output parameters. The ISL8273M can be used with any SMBus host device. In addition, the module is compatible with PMBus Power System Management Protocol Specification Parts I and II version 1.2. The ISL8273M accepts most standard PMBus commands. When configuring the device using PMBus commands, it is recommended that the enable pin is tied to SGND.

The SMBus device address is the only parameter that must be set by the external pins. All other device parameters can be set using PMBus commands.

The ISL8273M can operate without the PMBus in pin-strap mode with configurations programmed by pin-strap resistors, such as output voltage, switching frequency, device SMBus address, input UVLO, soft-start/stop, and current sharing. Note: pin-strap resistors with 1% tolerance or better should be used for all the pin-strap settings.

### Output Voltage Selection

The output voltage can be set to a voltage between 0.6V and 2.5V if the input voltage is higher than the desired output voltage by an amount sufficient to maintain regulation.

The VSET pin is used to set the output voltage to levels as shown in [Table 3](#). The R<sub>SET</sub> resistor is placed between the VSET pin and SGND. A standard 1% resistor is required.

TABLE 3. OUTPUT VOLTAGE RESISTOR SETTINGS

V <sub>OUT</sub> (V)	R <sub>SET</sub> (kΩ)
0.60	10
0.65	11
0.70	12.1
0.72	121 (available with FC04 firmware only)
0.75	13.3
0.80	14.7
0.85	16.2
0.88	133 (available with FC04 firmware only)
0.90	17.8
0.92	147 (available with FC04 firmware only)
0.95	19.6
1.00	21.5, or connect to SGND
1.05	23.7
1.10	26.1
1.15	28.7

TABLE 3. OUTPUT VOLTAGE RESISTOR SETTINGS (Continued)

V <sub>OUT</sub> (V)	R <sub>SET</sub> (kΩ)
1.20	31.6, or Open
1.25	34.8
1.30	38.3
1.40	42.2
1.50	46.4
1.60	51.1
1.70	56.2
1.80	61.9
1.90	68.1
2.00	75
2.10	82.5
2.20	90.9
2.30	100
2.50	110, or connect to V25

The output voltage can also be set to any value between 0.6V and 2.5V using the PMBus command VOUT\_COMMAND. This device supports dynamic voltage scaling, by allowing change to the output voltage set point during regulation. The voltage transition rate is specified by the PMBus command VOUT\_TRANSITION\_RATE.

By default, V<sub>OUT\_MAX</sub> is set to 110% of V<sub>OUT</sub> set by the pin-strap resistor, which can be changed to any value up to 2.75V by the PMBus command VOUT\_MAX.

### Soft-Start, Stop Delay, and Ramp Times

The ISL8273M follows an internal start-up procedure after power is applied to the VDD pin. The module requires approximately 60ms to 70ms to check for specific values stored in its internal memory and programmed by pin-strap resistors. When this process is completed, the device is ready to accept commands from the PMBus interface and the module is ready to be enabled. If the module is to be synchronized to an external clock source, the clock frequency must be stable before asserting the EN pin.

It may be necessary to set a delay from when an enable signal is received until the output voltage starts to ramp to its target value. In addition, the designer may wish to precisely set the time required for V<sub>OUT</sub> to ramp to its target value after the delay period has expired. These features can be used as part of an overall inrush current management strategy or to precisely control how fast a load IC is turned on. The ISL8273M gives the system designer several options for precisely and independently controlling both the delay and ramp time periods. The soft-start delay period begins when the EN pin is asserted and ends when the delay time expires.

The soft-start delay and ramp-up time can be programmed to custom values using the PMBus commands TON\_DELAY and TON\_RISE. When the delay time is set to 0ms, the device begins its ramp-up after the internal circuitry has initialized (approximately 2ms). When the soft-start ramp period is set



to 0ms, the output ramps up as quickly as the output load capacitance and loop settings allow. It is generally recommended to set the soft-start ramp to a value greater than 1ms to prevent inadvertent fault conditions due to excessive inrush current.

Similar to the soft-start delay and ramp-up time, the delay and ramp down time for soft-stop/off can be programmed using the PMBus commands TOFF\_DELAY and TOFF\_FALL. In addition, the module can be configured as “immediate off” using the command ON\_OFF\_CONFIG, such that the internal MOSFETs are turned off immediately after the delay time expires.

In current sharing mode, in which multiple ISL8273M modules are connected in parallel, ASCR is required to be disabled for the ramp-up with the USER\_CONFIG command. Therefore, the soft-start rise time is not equal to TON\_RISE. It can be calculated approximately by [Equation 1](#).

$$\text{Rise Time (ms)} \approx \frac{\text{TON\_RISE}}{V_{\text{IN}} \times f_{\text{SW}}} \times 330\text{kHz} \times 12\text{V} \quad (\text{EQ. 1})$$

Also in current sharing mode, ASCR will be enabled automatically upon power-good assertion after the ramp completes. To avoid premature ASCR turn on, it is recommended to increase POWER\_GOOD\_DELAY if the rise time exceeds 10ms. In addition, only “immediate off” is supported for current sharing.

In current sharing mode, if module self enable is used (VIN power-up), a minimum TON\_DELAY of 15ms is recommended.

The SS/UVLO pin can be used to program the soft-start/stop delay time and ramp time to some typical values as shown in [Table 4](#).

TABLE 4. SOFT-START/STOP RESISTOR SETTINGS

DELAY TIME (ms)	RAMP TIME (ms)	RSET (kΩ)
5	2	19.6, or connect to SGND
10	2	21.5
5	5	23.7, or Open
10	5	26.1
20	5	28.7
5	10	31.6
10	10	34.8, or connect to V25
20	10	38.3
5	2	42.2
10	2	46.4
5	5	51.1
10	5	56.2
20	5	61.9
5	10	68.1
10	10	75
20	10	82.5

## Power-Good

The ISL8273M provides a Power-Good (PG) signal that indicates the output voltage is within a specified tolerance of its target level and no fault condition exists. By default, the PG pin asserts if the output is within 10% of the target voltage. This limit can be changed using the PMBus command POWER\_GOOD\_ON.

A PG delay period is defined as the time from when all conditions within the ISL8273M for asserting PG are met to when the PG pin is actually asserted. This feature is commonly used instead of using an external reset controller to control external digital logic. A PG delay can be programmed using the PMBus command POWER\_GOOD\_DELAY.

## Switching Frequency and PLL

The device's switching frequency is set from 296kHz to 1067kHz using the pin-strap method (for stand-alone noncurrent sharing module only) as shown in [Table 5](#), or by using the PMBus command FREQUENCY\_SWITCH. The ISL8273M incorporates an internal Phase-locked Loop (PLL) to clock the internal circuitry. The PLL can be driven by an external clock source connected to the SYNC pin. It is recommended that when using an external clock, the same frequency should be set in the FREQUENCY\_SWITCH command. If the external clock is lost, the module will automatically switch to the internal clock. When using the internal oscillator, the SYNC pin can be configured as a clock source and as external sync to other modules. Refer to the SYNC\_CONFIG command on [page 49](#) for more information.

TABLE 5. SWITCHING FREQUENCY RESISTOR SETTINGS

f <sub>sw</sub> (kHz)	RSET (kΩ)
296	14.7, or connect to SGND
320	16.2
364	17.8
400	19.6
421	21.5, or Open
471	23.7
533	26.1
571	28.7
615	31.6, or connect to V25
727	34.8
800	38.3
842	42.2
889	46.4
1067	51.1

## Loop Compensation

The module loop response is programmable using the PMBus command `ASCR_CONFIG` or by using the pin-strap method (`ASCR` pin) according to [Table 6](#). The ISL8273M uses the ChargeMode control algorithm that responds to the output current changes within a single PWM switching cycle, achieving a smaller total output voltage variation with less output capacitance than traditional PWM controllers.

**TABLE 6. ASCR RESISTOR SETTINGS**

ASCR GAIN	ASCR RESIDUAL	R <sub>SET</sub> (kΩ)
80	90	10
120	90	11, or connect to SGND
160	90	12.1
200	90	13.3, or Open
240	90	14.7
280	90	16.2
320	90	17.8
360	90	19.6
400	90	21.5
450	90	23.7
500	90	26.1
550	90	28.7
600	90	31.6
700	90	34.8
800	90	38.3
80	100	42.2
120	100	46.4
160	100	51.1
200	100	56.2
240	100	61.9
280	100	68.1
320	100	75
360	100	82.5
400	100	90.9
450	100	100
500	100	110, or connect to V25
550	100	121
600	100	133
700	100	147
800	100	162

## Input Undervoltage Lockout (UVLO)

The input Undervoltage Lockout (UVLO) prevents the ISL8273M from operating when the input falls below a preset threshold, indicating the input supply is out of its specified range. The UVLO threshold ( $V_{UVLO}$ ) can be set between 4.18V and 16V by using the PMBus command `VIN_UV_FAULT_LIMIT`. Using the pin-strap method (`SS/UVLO` pin) as shown in [Table 7](#) allows to set the  $V_{UVLO}$  to two typical values.

A fault response to an input undervoltage fault can be programmed by the PMBus command `VIN_UV_FAULT_RESPONSE`. If the input undervoltage fault retry is enabled, the module will shut down immediately when the input voltage falls below  $V_{UVLO}$  and then continuously checks the input voltage after a retry delay time, which can be configured from 35ms to 280ms. If the input voltage rises above the input undervoltage warning level, the module will restart. The input undervoltage warning is  $1.05 \cdot V_{UVLO}$  by default and can be programmed by the PMBus command `VIN_UV_WARN_LIMIT`. Note that fault retry is not supported in current sharing configuration.

**TABLE 7. UVLO RESISTOR SETTINGS**

UVLO (V)	R <sub>SET</sub> (kΩ)
4.5	Open
4.5	Connect to V25
4.5	Connect to SGND
4.5	19.6, 21.5, 23.7, 26.1, 28.7, 31.6, 34.8, 38.3
10.8	42.2, 46.4, 51.1, 56.2, 61.9, 68.1, 75, 82.5

## SMBus Module Address Selection

Each module must have its own unique serial address to distinguish between other devices on the bus. The module address is set by connecting a resistor between pins SA and SGND. [Table 8](#) lists the available module addresses.

**TABLE 8. SMBus ADDRESS RESISTOR SELECTION**

R <sub>SA</sub> (kΩ)	SMBus ADDRESS
10	19h
11	1Ah
12.1	1Bh
13.3	1Ch
14.7	1Dh
16.2	1Eh
17.8	1Fh
19.6	20h
21.5	21h
23.7	22h
26.1	23h
28.7	24h
31.6	25h
34.8, or connect to SGND	26h
38.3	27h
42.2, or Open	28h
46.4	29h
51.1	2Ah

**TABLE 8. SMBus ADDRESS RESISTOR SELECTION (Continued)**

R <sub>SA</sub> (kΩ)	SMBus ADDRESS
56.2	2Bh
61.9	2Ch
68.1	2Dh
75	2Eh
82.5	2Fh
90.9	30h
100	31h
110	32h
121	33h
133	34h
147	35h
162	36h
178	37h

## Output Overvoltage Protection

The ISL8273M offers an internal output overvoltage protection circuit that can protect sensitive load circuitry from being subjected to a voltage higher than its prescribed limits. A hardware comparator is used to compare the actual output voltage (seen at pins V<sub>SENP</sub>, V<sub>SENN</sub>) to a threshold set to 15% higher than the target output voltage (default setting). The fault threshold can be programmed to a desired level by the PMBus command V<sub>OUT\_OV\_FAULT\_LIMIT</sub>. If the V<sub>SENP</sub> - V<sub>SENN</sub> voltage exceeds this threshold, the module will initiate an immediate shutdown without retry. Continuous retry can be enabled using the PMBus command V<sub>OUT\_OV\_FAULT\_RESPONSE</sub>. The retry delay time can be configured from 35ms to 280ms. Note that fault retry is not supported in current sharing configuration.

Internal to the module, two 100Ω resistors are populated from V<sub>OUT</sub> to V<sub>SENP</sub> and SGND to V<sub>SENN</sub> to protect the module from overvoltage conditions in case of open at the voltage sensing pins and differential remote sense traces due to assembly error. As long as differential remote sense traces have low resistance, V<sub>OUT</sub> regulation accuracy is not compromised.

## Output Prebias Protection

An output prebias condition exists when an externally applied voltage is present on a power supply's output before the power supply's control IC is enabled. Certain applications require that the converter not be allowed to sink current during start-up if a prebias condition exists at the output. The ISL8273M provides prebias protection by sampling the output voltage before initiating an output ramp.

If a prebias voltage lower than the target voltage exists after the preconfigured delay period has expired, the target voltage is set to match the existing prebias voltage and both drivers are enabled. The output voltage is then ramped to the final regulation value at the preconfigured ramp rate.

The actual time the output takes to ramp from the prebias voltage to the target voltage varies, depending on the prebias voltage. However, the total time elapsed from when the delay period expires to when the output reaches its target value will match the preconfigured ramp time (see [Figure 24](#)).

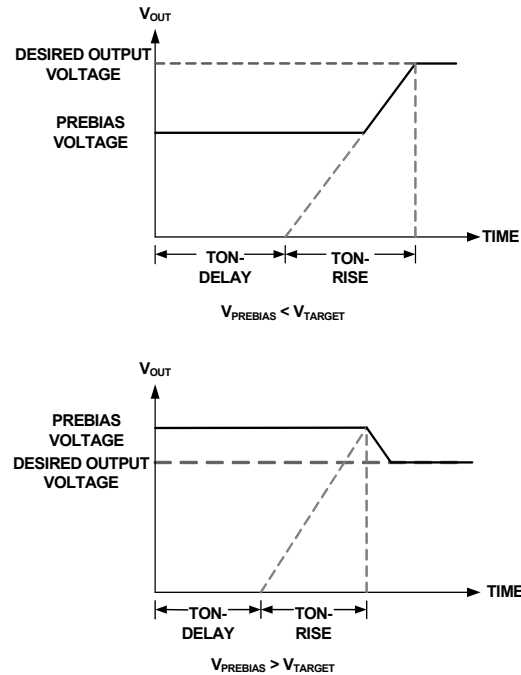
**FIGURE 24. OUTPUT RESPONSES TO PREBIAS VOLTAGES**

If a prebias voltage is higher than the target voltage after the preconfigured delay period has expired, the target voltage is set to match the existing prebias voltage. Thus, both drivers are enabled with a PWM duty cycle that would ideally create the prebias voltage.

When the preconfigured soft-start ramp period has expired, the PG pin is asserted (assuming the prebias voltage is not higher than the overvoltage limit). The PWM then adjusts its duty cycle to match the original target voltage and the output ramps down to the preconfigured output voltage.

If a prebias voltage is higher than the overvoltage limit, the device does not initiate a turn-on sequence and declares an overvoltage fault condition. The device then responds based on the output overvoltage fault response setting programmed by the PMBus command V<sub>OUT\_OV\_FAULT\_RESPONSE</sub>.

## Output Overcurrent Protection

The ISL8273M is protected from damage if the output is shorted to ground or if an overload condition is imposed on the output. The average output overcurrent fault threshold can be programmed by the PMBus command I<sub>OUT\_OC\_FAULT\_LIMIT</sub>. The module automatically programs the peak inductor current fault threshold by calculating inductor ripple current based on input voltage, switching frequency, and V<sub>OUT\_COMMAND</sub>. When the peak inductor current crosses the peak inductor current fault threshold for three successive switching cycles, the module will initiate an immediate shutdown.

The default response from an overcurrent fault is an immediate shutdown without retry. A continuous retry can be enabled using the PMBus command `MFR_IOUT_OC_FAULT_RESPONSE`. Note that fault retry is not supported in the current sharing configuration.

### Thermal Overload Protection

The ISL8273M includes a thermal sensor that continuously measures the internal temperature of the module and shuts down the controller when the temperature exceeds the preset limit. The factory default temperature limit is set to +125°C. The temperature limit can be changed using the PMBus command `OT_FAULT_LIMIT`.

The default response from an over-temperature fault is an immediate shutdown without retry. Retry settings can be programmed using the PMBus command `OT_FAULT_RESPONSE`. Hysteresis is implemented with the over-temperature fault retry. If a retry is enabled, the module will shut down immediately upon an over-temperature fault event and then continuously checks the temperature after a retry delay time, which can be configured from 35ms to 280ms. If the temperature falls below the over-temperature warning level, the module will restart. The over-temperature warning is +105°C by default and programmable using the PMBus command `OT_WARN_LIMIT`. Note that fault retry is not supported in the current sharing configuration.

### Digital-DC Bus

The Digital-DC Communications (DDC) bus is used to communicate between Intersil's digital power modules and digital controllers. The DDC bus provides the communication channel between devices for features such as current sharing, sequencing, and fault spreading. The DDC pin on all Digital-DC devices in an application should be connected together. A pull-up resistor is required on the DDC bus to guarantee the rise time as shown in [Equation 2](#):

$$\text{Rise Time} = R_{PU} * C_{LOAD} < 1\mu\text{s} \quad (\text{EQ. 2})$$

Where  $R_{PU}$  is the DDC bus pull-up resistance and  $C_{LOAD}$  is the bus loading. The pull-up resistor can be tied to an external 3.3V or 5V supply as long as this voltage is present before or during the device power-up. In principle, each device connected to the DDC bus represents approximately 10pF of capacitive loading, and each inch of FR4 PCB trace introduces approximately 2pF. The ideal design uses a central pull-up resistor that is well-matched to the total load capacitance.

### Active Current Sharing

Multiple ISL8273M modules can be used in parallel to increase the output current capability of a single power rail. By connecting the DDC and SYNC pins of each module together and configuring the modules as a current sharing rail, the units will share the current equally within a few percent.

[Figure 25](#) illustrates a typical connection for two modules.

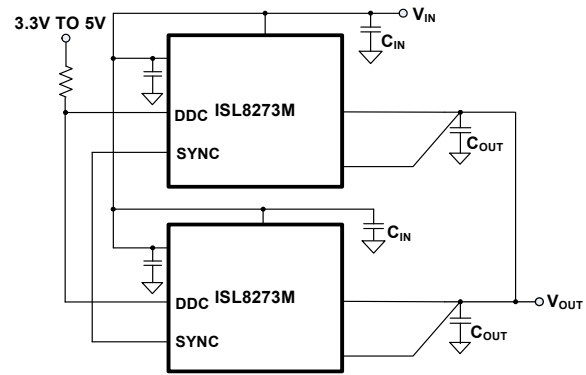

FIGURE 25. CURRENT SHARING GROUP

The ISL8273M uses a DDC bus based digital current sharing technique to balance the steady-state module output current by aligning the load lines of member modules to a reference module.

When multiple ISL8273M modules are connected for current sharing, a non-zero active droop resistance must be set to add artificial resistance in the output voltage path to control the slope of the load line curve, calibrating out the physical parasitic mismatches due to the power train components and PCB layout. The active droop resistance can be programmed using the PMBus command `VOUT_DROOP` based on [Equation 3](#). Typically, a higher droop value offers a more accurate dynamic current sharing at the expense of the output load regulation. 1% droop at full load will be a good trade-off between output load regulation and dynamic current sharing.

$$\frac{V_{OUT}}{I_{LOAD(MAX)}} \times 0.005 \leq \text{Droop} \leq \frac{V_{OUT}}{I_{LOAD(MAX)}} \times 0.015 \quad (\text{EQ. 3})$$

At system start-up, the module with the lowest device position as selected in the `DDC_CONFIG` is defined as the reference module. The remaining modules are members. The reference module broadcasts its current over the DDC bus. The members use the reference current information to trim their voltages ( $V_{MEMBER}$ ) to balance the current loading of each module in the system.

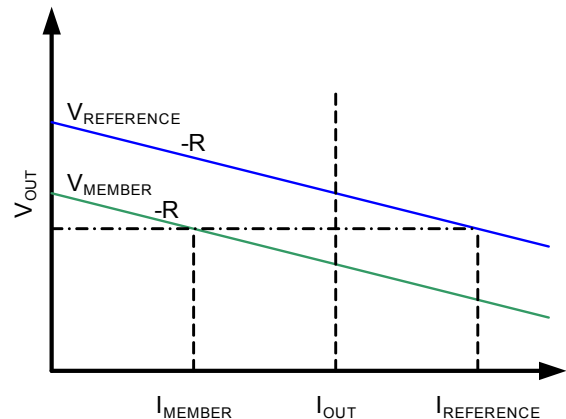

FIGURE 26. ACTIVE CURRENT SHARING

Figure 26 shows that for load lines with identical slopes, the member voltage is increased towards the reference voltage, which closes the gap between the inductor currents.

The relation between reference and member currents and voltage is given by Equation 4:

$$V_{\text{MEMBER}} = V_{\text{OUT}} + R \times (I_{\text{REFERENCE}} - I_{\text{MEMBER}}) \quad (\text{EQ. 4})$$

where  $R$  is the value of the droop resistance.

The DDC\_CONFIG command configures the module for active current sharing. The default setting is a stand-alone noncurrent sharing module.

For the fault configuration, it is required to enable the fault spreading mode in the current sharing rail with the PMBus command DDC\_GROUP. Broadcast operation must be enabled using the DDC\_GROUP command to allow start-up/shutdown and margining operations. It is optional to enable the  $V_{\text{OUT}}$  broadcast in the DDC\_GROUP command to allow  $V_{\text{OUT}}$  set point to change dynamically during operation.

In multiple-module current sharing configuration, it is required to synchronize all modules to the same switching clock by tying the SYNC pins together. The clock source can be selected either from one module or from an external clock using the SYNC\_CONFIG command. The phase offset of current sharing modules is automatically set according to the device positions and number of devices specified in the DDC\_CONFIG command.

The pin-strap method is offered for the current sharing configuration with the CS pin. Table 9 lists the current sharing pin-strap settings.

TABLE 9. CURRENT SHARING RESISTOR SETTINGS

CLOCK CONFIGURATION	DEVICE POSITION NUMBER OF DEVICES	DROOP (mV/A)	R <sub>SET</sub> (kΩ)
Output internal	1-2	0.07	10
External	2-2	0.07	11
Output internal	1-2	0.1	12.1
External	2-2	0.1	13.3
Output internal	1-2	0.13	14.7
External	2-2	0.13	16.2
Output internal	1-2	0.17	17.8
External	2-2	0.17	19.6
Output internal	1-2	0.21	21.5
External	2-2	0.21	23.7
Output internal	1-3	0.05	26.1
External	2-3	0.05	28.7
External	3-3	0.05	31.6
Output internal	1-3	0.07	34.8
External	2-3	0.07	38.3
External	3-3	0.07	42.2
Output internal	1-3	0.09	46.4
External	2-3	0.09	51.1
External	3-3	0.09	56.2

TABLE 9. CURRENT SHARING RESISTOR SETTINGS (Continued)

CLOCK CONFIGURATION	DEVICE POSITION NUMBER OF DEVICES	DROOP (mV/A)	R <sub>SET</sub> (kΩ)
Output internal	1-3	0.11	61.9
External	2-3	0.11	68.1
External	3-3	0.11	75
Output internal	1-3	0.14	82.5
External	2-3	0.14	90.9
External	3-3	0.14	100
Output internal	1-4	0.07	110 (available with FC03 and FC04 firmware only)
External	2-4	0.07	121 (available with FC03 and FC04 firmware only)
External	3-4	0.07	133 (available with FC03 and FC04 firmware only)
External	4-4	0.07	147 (available with FC03 and FC04 firmware only)
Internal only	1-1	0	Connect to SGND (for immediate off)
Internal only	1-1	0	OPEN (for soft-off)

NOTE: Fault retry is not supported in the current sharing configuration.

## Phase Spreading

When multiple point-of-load converters share a common DC input supply, it is desirable to adjust the clock phase offset of each device, so that not all devices start to switch simultaneously. Setting each converter to start its switching cycle at a different point in time can dramatically reduce input capacitance requirements and efficiency losses. Since the peak current drawn from the input supply is effectively spread out over a period of time, the peak current drawn at any given moment is reduced, and the power losses proportional to the  $I_{\text{RMS}}^2$  are reduced dramatically.

To enable phase spreading, all converters must be synchronized to the same switching clock. The phase offset of each device can also be set to any value between 0° and 360° in 22.5° increments with the PMBus command INTERLEAVE. By default, the internal two phases of the module maintain a phase difference of 180°.

## Fault Spreading

Digital-DC modules and devices can be configured to broadcast a fault event over the DDC bus to the other devices in the group using the PMBus command DDC\_GROUP. When a nondestructive fault occurs, the device shuts down and broadcasts the fault event over the DDC bus. The other devices on the DDC bus shut down simultaneously if configured to do so.

Note that fault retry is not supported in multiple modules with fault spreading enabled, such as current sharing configuration.

## Output Sequencing

A group of Digital-DC modules or devices can be configured to power up in a predetermined sequence. This feature is especially useful when powering advanced processors (FPGAs and ASICs)

that require one supply to reach its operating voltage before another supply reaching it to avoid latch-up. Multidevice sequencing can be achieved by configuring each device with the PMBus command SEQUENCE. Multiple device sequencing is configured by issuing PMBus commands to assign the preceding device in the sequencing chain as well as the device that follows the sequence.

The Enable pins of all devices in a sequencing group must be tied together and driven high to initiate a sequenced turn-on of the group. The enable must be driven low to initiate a sequenced turnoff of the group. It is recommended to enable fault spreading with the PMBus command DDC\_GROUP within a sequencing group.

## Monitoring with SMBus

The ISL8273M can monitor a wide variety of different system parameters using the PMBus commands:

- READ\_VIN
- READ\_VOUT
- READ\_IOUT
- READ\_INTERNAL\_TEMP
- READ\_DUTY\_CYCLE
- READ\_FREQUENCY
- READ\_VMON

## Snapshot Parameter Capture

The ISL8273M offers a special feature to capture parametric data and fault status following a fault. Detailed description is provided in the [“PMBus Commands Description” on page 28](#) under PMBus command SNAPSHOT and SNAPSHOT\_CONTROL.

## Nonvolatile Memory

The ISL8273M stores user configurations in the internal nonvolatile memory. Integrated security measures ensure that the user can only restore the module to a level that has been made available to them. During the initialization process, the ISL8273M checks for stored values contained in its internal nonvolatile memory.

Modules are shipped with factory defaults configuration and most settings can be overwritten by PMBus Commands and can be stored in nonvolatile memory by the PMBus command STORE\_USER\_ALL.

## Layout Guide

To achieve stable operation, low losses and good thermal performance some layout considerations are necessary. See [Figure 27](#) for the recommended layout.

- Establish separate SGND and PGND planes, then connect SGND to PGND on a middle layer and underneath PAD6 with a single point connection. For SGND and PGND pin connections, such as small pins H16, J16, M5, and M17..., use multiple vias for each pin to connect to the inner SGND or PGND layer.
- To minimize high frequency noise, place enough ceramic capacitors between VIN and PGND and VOUT and PGND.

Place bypass capacitors between VDD, VDRV, and the ground plane, as close to the module as possible. It is critical to place the output ceramic capacitors close to the VOUT pads and in the direction of the load current path to create a low impedance path for the high frequency inductor ripple current.

- Use large copper areas for the power path (VIN, PGND, VOUT) to minimize conduction loss and thermal stress. Also, use multiple vias to connect the power planes in different layers. It is recommended to enlarge PAD11 and 15 and place more vias on them. The ceramic capacitors CIN can be placed on the bottom layer under these two pads.
- Connect remote sensing traces to the regulation point to achieve a tight output voltage regulation and place the two traces in parallel. Route a trace from VSENN and VSENP to the point of load where the tight output voltage is desired. Avoid routing any sensitive signal traces, such as the VSENN, VSENP sensing lines near the SW pins.
- PAD14 and 16 (SW1 and SW2) are noisy pads, but they are beneficial for thermal dissipation. If the noise issue is critical for the application, it is recommended to use only the top layer for the SW pads. For better thermal performance, use multiple vias on these pads to connect into the SW inner and bottom layers. However, caution must be taken when placing a limited area of SW planes in any layer. The SW planes should avoid the sensing signals and should be surrounded by the PGND layer to avoid the noise coupling.
- For pins SWD1 (L3) and SWD2 (P10), it is recommended to connect to the related SW1 and SW2 pads with short loop wires. The wire width should be more than 20mils.

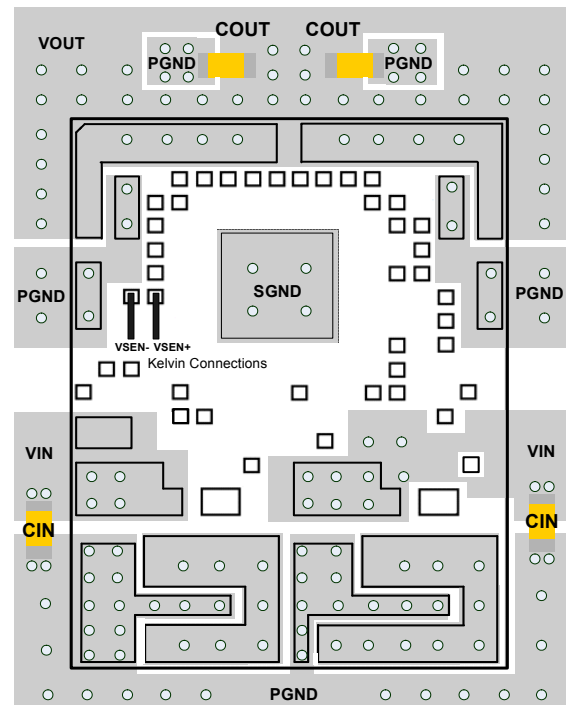

FIGURE 27. RECOMMENDED LAYOUT

## Thermal Considerations

Experimental power loss curves along with  $\theta_{JA}$  from thermal modeling analysis can be used to evaluate the thermal consideration for the module. The derating curves are derived from the maximum power allowed while maintaining the temperature below the maximum junction temperature of +120°C. The derating curves are derived based on tests of the ISL8273MEVAL1Z evaluation board, which is an 8-layer board 4.7x4.8inch in size with 2oz Cu on all layers and multiple via interconnects. In the actual application, other heat sources and design margins should be considered.

### Package Description

The structure of the ISL8273M belongs to the High Density Array no-lead package (HDA). This kind of package has advantages such as good thermal and electrical conductivity, low weight, and small size. The HDA package is applicable for surface mounting technology and is being more readily used in the industry. The ISL8273M contains several types of devices, including resistors, capacitors, inductors, and control ICs. The ISL8273M is a copper leadframe based package with exposed copper thermal pads, which have good electrical and thermal conductivity. The copper leadframe and multicomponent assembly is overmolded with a polymer mold compound to protect these devices.

The package outline and typical Printed Circuit Board (PCB) layout pattern design and typical stencil pattern design are shown on [pages 55, 56](#), and [57](#). The module has a small size of 18mmx23mmx7.5mm.

### PCB Layout Pattern Design

The bottom of the ISL8273M is a leadframe footprint, which is attached to the PCB by a surface mounting process. The PCB layout pattern is shown on [page 57](#) through [59](#). The PCB layout pattern is an array of solder mask defined PCB lands which align with the perimeters of the HDA exposed pads and I/O termination dimensions. The thermal lands on the PCB layout also feature an array of solder mask defined lands and should match 1:1 with the package exposed die pad perimeters. The exposed solder mask defined PCB land area should be 50-80% of the available module I/O area.

### Thermal Vias

A grid of 1.0mm to 1.2mm pitch thermal vias, which drops down and connects to buried copper plane(s), should be placed under the thermal land. The vias should be about 0.3mm to 0.33mm in diameter with the barrel plated to about 1.0 oz. of copper. Although adding more vias (by decreasing via pitch) will improve the thermal performance, diminishing returns will be seen as the number of vias is increased. Use as many vias as practical for the thermal land size and your board design rules will allow.

### Stencil Pattern Design

Reflowed solder joints on the perimeter I/O lands should have about a 50µm to 75µm (2mil to 3mil) standoff height. The solder paste stencil design is the first step in developing optimized, reliable solder joints. Stencil aperture size to solder mask defined PCB land size ratio should typically be 1:1. The aperture width can be reduced slightly to help prevent solder bridging

between adjacent I/O lands. A typical solder stencil pattern is shown in the “[Package Outline Drawing](#)” section starting on [page 53](#). A typical solder stencil pattern is shown starting on [page 55](#). The user should consider the symmetry of the whole stencil pattern when designing its pads. A laser cut, stainless steel stencil with electropolished trapezoidal walls is recommended. Electropolishing “smooths” the aperture walls resulting in reduced surface friction and better paste release, which reduces voids. Using a Trapezoidal Section Aperture (TSA) also promotes paste release and forms a brick like paste deposit that assists in firm component placement. A 0.1mm to 0.15mm stencil thickness is recommended for this large pitch HDA.

### Reflow Parameters

Due to the low mount height of the HDA, “No-Clean” Type 3 solder paste per ANSI/J-STD-005 is recommended. A nitrogen purge is also recommended during reflow. A system board reflow profile depends on the thermal mass of the entire populated board, so it is not practical to define a specific soldering profile just for the HDA. The profile given in [Figure 28](#) is provided as a guideline, which can be customized for varying manufacturing practices and applications.

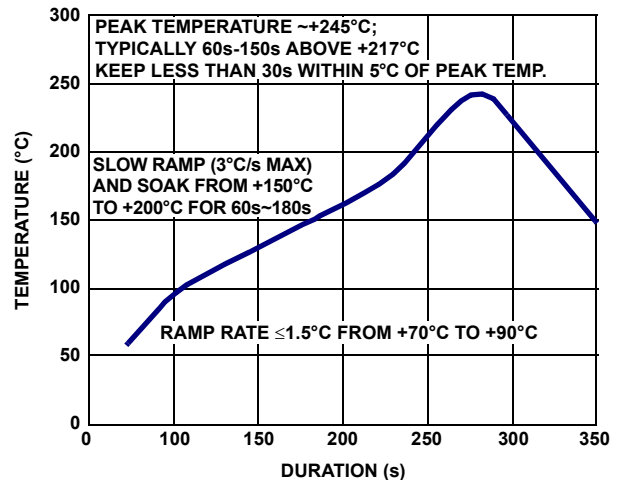

FIGURE 28. TYPICAL REFLOW PROFILE

## PMBus Command Summary

COMMAND CODE	COMMAND NAME	DESCRIPTION	TYPE	DATA FORMAT	DEFAULT VALUE	DEFAULT SETTING	PAGE
01h	OPERATION	Sets Enable, Disable, and $V_{OUT}$ Margin modes.	R/W BYTE	BIT			<a href="#">28</a>
02h	ON_OFF_CONFIG	Configures the EN pin and PMBus commands to turn the unit ON/OFF	R/W BYTE	BIT	16h	Hardware Enable, Soft Off	<a href="#">28</a>
03h	CLEAR_FAULTS	Clears fault indications.	SEND BYTE				<a href="#">29</a>
15h	STORE_USER_ALL	Stores all PMBus values written since last restore at user level.	SEND BYTE				<a href="#">29</a>
16h	RESTORE_USER_ALL	Restores PMBus settings that were stored using STORE_USER_ALL.	SEND BYTE				<a href="#">29</a>
20h	VOUT_MODE	Preset to defined data format of $V_{OUT}$ commands.	READ BYTE	BIT	13h	Linear Mode, Exponent = -13	<a href="#">29</a>
21h	VOUT_COMMAND	Sets the nominal value of the output voltage.	R/W WORD	L16u		Pin-strap	<a href="#">29</a>
23h	VOUT_CAL_OFFSET	Applies a fixed offset voltage to the VOUT_COMMAND.	R/W WORD	L16s	0000h	0V	<a href="#">30</a>
24h	VOUT_MAX	Sets the maximum possible value of $V_{OUT}$ . 110% of pin-strap $V_{OUT}$ .	R/W WORD	L16u		1.1* $V_{OUT}$ Pin-strap	<a href="#">30</a>
25h	VOUT_MARGIN_HIGH	Sets the value of the $V_{OUT}$ during a margin high.	R/W WORD	L16u		1.05* $V_{OUT}$ Pin-strap	<a href="#">30</a>
26h	VOUT_MARGIN_LOW	Sets the value of the $V_{OUT}$ during a margin low.	R/W WORD	L16u		0.95* $V_{OUT}$ Pin-strap	<a href="#">30</a>
27h	VOUT_TRANSITION_RATE	Sets the transition rate during margin or other change of $V_{OUT}$ .	R/W WORD	L11	BA00h	1V/ms	<a href="#">30</a>
28h	VOUT_DROOP	Sets the loadline (V/I Slope) resistance for the rail.	R/W WORD	L11		Pin-strap	<a href="#">31</a>
33h	FREQUENCY_SWITCH	Sets the switching frequency.	R/W WORD	L11		Pin-strap	<a href="#">31</a>
37h	INTERLEAVE	Configures a phase offset between devices sharing a SYNC clock.	R/W WORD	BIT	0000h		<a href="#">31</a>
38h	IOUT_CAL_GAIN	Sense resistance for inductor DCR current sensing.	R/W WORD	L11	B370h	0.86m $\Omega$	<a href="#">31</a>
39h	IOUT_CAL_OFFSET	Sets the current-sense offset.	R/W WORD	L11	0000h	0A	<a href="#">31</a>
40h	VOUT_OV_FAULT_LIMIT	Sets the $V_{OUT}$ overvoltage fault threshold.	R/W WORD	L16u		1.15* $V_{OUT}$ Pin-strap	<a href="#">32</a>
41h	VOUT_OV_FAULT_RESPONSE	Configures the $V_{OUT}$ overvoltage fault response.	R/W BYTE	BIT	80h	Disable and No Retry	<a href="#">32</a>
42h	VOUT_OV_WARN_LIMIT	Sets the $V_{OUT}$ overvoltage warn threshold.	R/W WORD	L16u		1.10* $V_{OUT}$ Pin-strap	<a href="#">32</a>
43h	VOUT_UV_WARN_LIMIT	Sets the $V_{OUT}$ undervoltage warn threshold.	R/W WORD	L16u		0.9* $V_{OUT}$ Pin-strap	<a href="#">32</a>
44h	VOUT_UV_FAULT_LIMIT	Sets the $V_{OUT}$ undervoltage fault threshold.	R/W WORD	L16u		0.85* $V_{OUT}$ Pin-strap	<a href="#">32</a>
45h	VOUT_UV_FAULT_RESPONSE	Configures the $V_{OUT}$ undervoltage fault response.	R/W BYTE	BIT	80h	Disable and No Retry	<a href="#">33</a>
46h	IOUT_OC_FAULT_LIMIT	Sets the $I_{OUT}$ average overcurrent fault threshold.	R/W WORD	L11	EAD0h	90A	<a href="#">33</a>



## PMBus Command Summary (Continued)

COMMAND CODE	COMMAND NAME	DESCRIPTION	TYPE	DATA FORMAT	DEFAULT VALUE	DEFAULT SETTING	PAGE
4Ah	IOUT_OC_WARN_LIMIT	Sets the I <sub>OUT</sub> average overcurrent warning threshold. Available only with FC03 and FC04 firmware	R/W WORD	L11		0.9 * IOUT_OC_FAULT_LIMIT	<a href="#">33</a>
4Bh	IOUT_UC_FAULT_LIMIT	Sets the I <sub>OUT</sub> average undercurrent fault threshold.	R/W WORD	L11	E4E0h	-50A	<a href="#">33</a>
4Fh	OT_FAULT_LIMIT	Sets the over-temperature fault threshold.	R/W WORD	L11	EBE8h	+125° C	<a href="#">34</a>
50h	OT_FAULT_RESPONSE	Configures the over-temperature fault response.	R/W BYTE	BIT	80h	Disable and No Retry	<a href="#">34</a>
51h	OT_WARN_LIMIT	Sets the over-temperature warning limit.	R/W WORD	L11	EB48h	+105° C	<a href="#">34</a>
52h	UT_WARN_LIMIT	Sets the under-temperature warning limit.	R/W WORD	L11	DC40h	-30° C	<a href="#">34</a>
53h	UT_FAULT_LIMIT	Sets the under-temperature fault threshold.	R/W WORD	L11	E580h	-40° C	<a href="#">35</a>
54h	UT_FAULT_RESPONSE	Configures the under-temperature fault response.	R/W BYTE	BIT	80h	Disable and No Retry	<a href="#">35</a>
55h	VIN_OV_FAULT_LIMIT	Sets the V <sub>IN</sub> overvoltage fault threshold.	R/W WORD	L11	D380h	14V	<a href="#">35</a>
56h	VIN_OV_FAULT_RESPONSE	Configures the V <sub>IN</sub> overvoltage fault response.	R/W BYTE	BIT	80h	Disable and No Retry	<a href="#">36</a>
57h	VIN_OV_WARN_LIMIT	Sets the input overvoltage warning limit.	R/W WORD	L11	D353h	13.3V	<a href="#">36</a>
58h	VIN_UV_WARN_LIMIT	Sets the input undervoltage warning limit.	R/W WORD	L11		1.05 * V <sub>IN</sub> UV Fault Limit	<a href="#">36</a>
59h	VIN_UV_FAULT_LIMIT	Sets the V <sub>IN</sub> undervoltage fault threshold.	R/W WORD	L11		Pin-strap	<a href="#">36</a>
5Ah	VIN_UV_FAULT_RESPONSE	Configures the V <sub>IN</sub> undervoltage fault response.	R/W BYTE	BIT	80h	Disable and No Retry	<a href="#">37</a>
5Eh	POWER_GOOD_ON	Sets the voltage threshold for Power-good indication.	R/W WORD	L16u		0.9 * V <sub>OUT</sub> Pin-strap	<a href="#">37</a>
60h	TON_DELAY	Sets the delay time from ENABLE to start of V <sub>OUT</sub> rise.	R/W WORD	L11		Pin-strap	<a href="#">37</a>
61h	TON_RISE	Sets the rise time of V <sub>OUT</sub> after ENABLE and TON_DELAY.	R/W WORD	L11		Pin-strap	<a href="#">37</a>
64h	TOFF_DELAY	Sets the delay time from DISABLE to start of V <sub>OUT</sub> fall.	R/W WORD	L11		Pin-strap	<a href="#">38</a>
65h	TOFF_FALL	Sets the fall time for V <sub>OUT</sub> after DISABLE and TOFF_DELAY.	R/W WORD	L11		Pin-strap	<a href="#">38</a>
78h	STATUS_BYTE	Returns an abbreviated status for fast reads.	READ BYTE	BIT	00h	No Faults	<a href="#">38</a>
79h	STATUS_WORD	Returns information with a summary of the unit's fault condition.	READ WORD	BIT	0000h	No Faults	<a href="#">39</a>
7Ah	STATUS_VOUT	Returns the V <sub>OUT</sub> specific status.	READ BYTE	BIT	00h	No Faults	<a href="#">40</a>
7Bh	STATUS_IOUT	Returns the I <sub>OUT</sub> specific status.	READ BYTE	BIT	00h	No Faults	<a href="#">40</a>
7Ch	STATUS_INPUT	Returns specific status specific to the input.	READ BYTE	BIT	00h	No Faults	<a href="#">40</a>

## PMBus Command Summary (Continued)

COMMAND CODE	COMMAND NAME	DESCRIPTION	TYPE	DATA FORMAT	DEFAULT VALUE	DEFAULT SETTING	PAGE
7Dh	STATUS_TEMP	Returns the temperature specific status.	READ BYTE	BIT	00h	No Faults	<a href="#">41</a>
7Eh	STATUS_CML	Returns the communication, logic and memory specific status.	READ BYTE	BIT	00h	No Faults	<a href="#">41</a>
80h	STATUS_MFR_SPECIFIC	Returns the VMON and external sync clock specific status.	READ BYTE	BIT	00h	No Faults	<a href="#">41</a>
88h	READ_VIN	Returns the input voltage reading.	READ WORD	L11			<a href="#">42</a>
8Bh	READ_VOUT	Returns the output voltage reading.	READ WORD	L16u			<a href="#">42</a>
8Ch	READ_IOUT	Returns the output current reading.	READ WORD	L11			<a href="#">42</a>
8Dh	READ_INTERNAL_TEMP	Returns the temperature reading internal to the device.	READ WORD	L11			<a href="#">42</a>
94h	READ_DUTY_CYCLE	Returns the duty cycle reading during the ENABLE state.	READ WORD	L11			<a href="#">42</a>
95h	READ_FREQUENCY	Returns the measured operating switch frequency.	READ WORD	L11			<a href="#">42</a>
96h	READ_IOUT_0	Returns phase 1 current reading.	READ WORD	L11			<a href="#">42</a>
97h	READ_IOUT_1	Returns phase 2 current reading.	READ WORD	L11			<a href="#">43</a>
99h	MFR_ID	Sets a user defined identification.	R/W BLOCK	ASC		Null	<a href="#">43</a>
9Ah	MFR_MODEL	Sets a user defined model.	R/W BLOCK	ASC		Null	<a href="#">43</a>
9Bh	MFR_REVISION	Sets a user defined revision.	R/W BLOCK	ASC		Null	<a href="#">43</a>
9Ch	MFR_LOCATION	Sets a user defined location identifier.	R/W BLOCK	ASC		Null	<a href="#">43</a>
9Dh	MFR_DATE	Sets a user defined date.	R/W BLOCK	ASC		Null	<a href="#">44</a>
9Eh	MFR_SERIAL	Sets a user defined serialized identifier.	R/W BLOCK	ASC		Null	<a href="#">44</a>
A8H	LEGACY_FAULT_GROUP	Sets rail IDs of legacy devices for fault spreading	R/W BLOCK	BIT	00000000h	No rail ID specified	<a href="#">44</a>
B0h	USER_DATA_00	Sets a user defined data.	R/W BLOCK	ASC		Null	<a href="#">44</a>
D0h	ISENSE_CONFIG	Configures ISENSE related features.	R/W BYTE	BIT	06h	256ns Blanking Time, High Range	<a href="#">45</a>
D1h	USER_CONFIG	Configures several user-level features.	R/W BYTE	BIT		Pin-strap (ASCR on/off for start-up)	<a href="#">45</a>
D3h	DDC_CONFIG	Configures the DDC bus.	R/W WORD	BIT		Pin-strap (set based on PMBus address and CS)	<a href="#">46</a>
D4h	POWER_GOOD_DELAY	Sets the delay between $V_{OUT} > PG$ threshold and asserting the PG pin.	R/W WORD	L11	C300h	3ms	<a href="#">46</a>
DFh	ASCR_CONFIG	Configures ASCR control loop.	R/W BLOCK	CUS		Pin-strap	<a href="#">46</a>
E0h	SEQUENCE	Identifies the Rail DDC ID to perform multi-rail sequencing.	R/W WORD	BIT	0000h	Prequel and Sequel Disabled	<a href="#">47</a>
E2h	DDC_GROUP	Sets rail DDC IDs to obey faults and margining spreading information.	R/W BLOCK	BIT		Pin-strap (set based on CS)	<a href="#">47</a>
E4h	DEVICE_ID	Returns the 16-byte (character) device identifier string.	READ BLOCK	ASC		Reads Device Version	<a href="#">48</a>
E5h	MFR_IOUT_OC_FAULT_RESPONSE	Configures the $I_{OUT}$ overcurrent fault response.	R/W BYTE	BIT	80h	Disable and No Retry	<a href="#">48</a>

## PMBus Command Summary (Continued)

COMMAND CODE	COMMAND NAME	DESCRIPTION	TYPE	DATA FORMAT	DEFAULT VALUE	DEFAULT SETTING	PAGE
E6h	MFR_IOUT_UC_FAULT_RESPONSE	Configures the IOUT undercurrent fault response.	R/W BYTE	BIT	80h	Disable and No Retry	<a href="#">48</a>
E9h	SYNC_CONFIG	Configures the SYNC pin.	R/W BYTE	BIT		Pin-strap (set based on CS)	<a href="#">49</a>
EAh	SNAPSHOT	Returns 32-byte read-back of parametric and status values.	READ BLOCK	BIT			<a href="#">49</a>
EBh	BLANK_PARAMS	Returns recently changed parameter values.	READ BLOCK	BIT	FF...FFh		<a href="#">49</a>
F3h	SNAPSHOT_CONTROL	Snapshot feature control command.	R/W BYTE	BIT			<a href="#">50</a>
F4h	RESTORE_FACTORY	Restores device to the factory default values.	SEND BYTE				<a href="#">50</a>
F5h	MFR_VMON_OV_FAULT_LIMIT	Returns the VMON overvoltage threshold.	READ WORD	L11	CB00h	6V	<a href="#">50</a>
F6h	MFR_VMON_UV_FAULT_LIMIT	Returns the VMON undervoltage threshold.	READ WORD	L11	CA00h	4V	<a href="#">50</a>
F7h	MFR_READ_VMON	Returns the VMON voltage reading.	READ WORD	L11			<a href="#">50</a>
F8h	VMON_OV_FAULT_RESPONSE	Returns the VMON overvoltage response.	READ BYTE	BIT	80h	Disable and No Retry	<a href="#">51</a>
F9h	VMON_UV_FAULT_RESPONSE	Returns the VMON undervoltage response.	READ BYTE	BIT	80h	Disable and No Retry	<a href="#">51</a>

## PMBus Data Formats

### Linear-11 (L11)

The L11 data format uses 5-bit two's complement exponent (N) and 11-bit two's complement mantissa (Y) to represent real world decimal value (X).

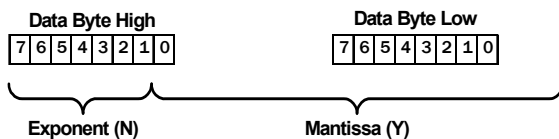

The relation between real world decimal value (X), N and Y is:  $X = Y \cdot 2^N$

### Linear-16 Unsigned (L16u)

The L16u data format uses a fixed exponent (hard-coded to  $N = -13h$ ) and a 16-bit unsigned integer mantissa (Y) to represent real world decimal value (X). Relation between real world decimal value (X), N and Y is:  $X = Y \cdot 2^{-13}$

### Linear-16 Signed (L16s)

The L16s data format uses a fixed exponent (hard-coded to  $N = -13h$ ) and a 16-bit two's complement mantissa (Y) to represent real world decimal value (X).

The relation between real world decimal value (X), N and Y is:  $X = Y \cdot 2^{-13}$

### Bit Field (BIT)

An explanation of the Bit Field for each command is provided in [“PMBus Commands Description” on page 28](#).

### Custom (CUS)

An explanation of the Custom data format for each command is provided in [“PMBus Commands Description” on page 28](#). A combination of Bit Field and integer is a common type of Custom data format.

### ASCII (ASC)

A variable length string of text characters using the ASCII data format.

## PMBus Use Guidelines

The PMBus is a powerful tool that allows the user to optimize circuit performance by configuring devices for their application. When configuring a device in a circuit, the device should be disabled whenever most settings are changed with PMBus commands. Some exceptions to this recommendation are OPERATION, ON\_OFF\_CONFIG, CLEAR\_FAULTS, VOUT\_COMMAND, VOUT\_MARGIN\_HIGH, VOUT\_MARGIN\_LOW, and ASCCR\_CONFIG. While the device is enabled any command can be read. Many commands do not take effect until after the device has been re-enabled, hence the recommendation that commands that change device settings are written while the device is disabled.

When sending the STORE\_USER\_ALL, and RESTORE\_USER\_ALL commands, it is recommended that no other commands are sent to the device for 100ms after sending STORE or RESTORE commands.

In addition, there should be a 2ms delay between repeated READ commands sent to the same device. When sending any other command, a 5ms delay is recommended between repeated commands sent to the same device.

### Summary

All commands can be read at any time.

Always disable the device when writing commands that change device settings. Exceptions to this rule are commands intended to be written while the device is enabled, for example, VOUT\_MARGIN\_HIGH.

To ensure a change to a device setting has taken effect, write the STORE\_USER\_ALL command, then cycle input power and re-enable.

## PMBus Commands Description

### OPERATION (01h)

**Definition:** Sets the Enable, Disable, and  $V_{OUT}$  Margin settings. Data values of OPERATION that force margin high or low take effect only when the MGN pin is left open (that is, in the NOMINAL margin state).

**Data Length in Bytes:** 1

**Data Format:** BIT

**Type:** R/W

**Default Value:**

**Units:** N/A

SETTINGS	ACTIONS
04h	Immediate off (no sequencing)
44h	Soft off (with sequencing)
84h	On - Nominal
94h	On - Margin low
A4h	On - Margin high

### ON\_OFF\_CONFIG (02h)

**Definition:** Configures the interpretation and coordination of the OPERATION command and the ENABLE pin (EN).

**Data Length in Bytes:** 1

**Data Format:** BIT

**Type:** R/W

**Default Value:** 16h (Device starts from ENABLE pin with soft-off)

**Units:** N/A

SETTINGS	ACTIONS
16h	Device starts from ENABLE pin with soft off.
17h	Device starts from ENABLE pin with immediate off.
1Ah	Device starts from OPERATION command with soft off.
1Bh	Device starts from OPERATION command with immediate off.

---

### **CLEAR\_FAULTS (03h)**

**Definition:** Clears all fault bits in all registers and releases the SALRT pin (if asserted) simultaneously. If a fault condition still exists, the bit will reassert immediately. This command will not restart a device if it has shut down, it will only clear the faults.

**Data Length in Bytes:** 0 Byte

**Data Format:** N/A

**Type:** Send byte

**Default Value:** N/A

**Units:** N/A

**Reference:** N/A

### **STORE\_USER\_ALL (15h)**

**Definition:** Stores all PMBus settings from the operating memory to the nonvolatile USER store memory. To clear the USER store, perform a RESTORE\_FACTORY then STORE\_USER\_ALL. To add to the USER store, perform a RESTORE\_USER\_ALL, write commands to be added, then STORE\_USER\_ALL. This command can be used during device operation, but the device will be unresponsive for 20ms while storing values.

**Data Length in Bytes:** 0

**Data Format:** N/A

**Type:** Send byte

**Default Value:** N/A

**Units:** N/A

### **RESTORE\_USER\_ALL (16h)**

**Definition:** Restores all PMBus settings from the USER store memory to the operating memory. Command performed at power-up. Security level is changed to Level 1 following this command. This command can be used during device operation, but the device will be unresponsive for 20ms while storing values.

**Data Length in Bytes:** 0

**Data Format:** N/A

**Type:** Send byte

**Default Value:** N/A

**Units:** N/A

### **VOUT\_MODE (20h)**

**Definition:** Reports the  $V_{OUT}$  mode and provides the exponent used in calculating several  $V_{OUT}$  settings. Fixed with linear mode with default exponent (N) = -13

**Data Length in Bytes:** 1

**Data Format:** BIT

**Type:** Read-only

**Default Value:** 13h (Linear Mode, N = -13)

**Units:** N/A

### **VOUT\_COMMAND (21h)**

**Definition:** Sets or reports the target output voltage. This command cannot set a value higher than  $V_{OUT\_MAX}$ .

**Data Length in Bytes:** 2

**Data Format:** L16u

**Type:** R/W

**Default Value:** Pin-strap setting

**Units:** Volts

**Range:** 0V to  $V_{OUT\_MAX}$

---

### **VOUT\_CAL\_OFFSET (23h)**

**Definition:** Applies a fixed offset voltage to the output voltage command value. This command is typically used by the user to calibrate a device in the application circuit.

**Data Length in Bytes:** 2

**Data Format:** L16s

**Type:** R/W

**Default Value:** 0000h

**Units:** Volts

### **VOUT\_MAX (24h)**

**Definition:** Sets an upper limit on the output voltage the unit can command regardless of any other commands or combinations. The intent of this command is to provide a safeguard against a user accidentally setting the output voltage to a possibly destructive level rather than to be the primary output overprotection. Default value can be changed using PMBus.

**Data Length in Bytes:** 2

**Data Format:** L16u

**Type:** R/W

**Default Value:** 1.10xVOUT\_COMMAND pin-strap setting

**Units:** Volts

**Range:** 0V to 5.5V

### **VOUT\_MARGIN\_HIGH (25h)**

**Definition:** Sets the value of the  $V_{OUT}$  during a margin high. This command loads the unit with the voltage to which the output is to be changed when the OPERATION command or MGN pin is set to "Margin High".

**Data Length in Bytes:** 2

**Data Format:** L16u

**Type:** R/W

**Default value:** 1.05 x VOUT\_COMMAND pin-strap setting

**Units:** V

**Range:** 0V to VOUT\_MAX

### **VOUT\_MARGIN\_LOW (26h)**

**Definition:** Sets the value of the  $V_{OUT}$  during a margin low. This command loads the unit with the voltage to which the output is to be changed when the OPERATION command or MGN pin is set to "Margin Low".

**Data Length in Bytes:** 2

**Data Format:** L16u

**Type:** R/W

**Default value:** 0.95 x VOUT\_COMMAND pin-strap setting

**Units:** V

**Range:** 0V to VOUT\_MAX

### **VOUT\_TRANSITION\_RATE (27h)**

**Definition:** Sets the rate at which the output should change voltage when the device receives the VOUT\_COMMAND or an OPERATION command (Margin High, Margin Low) that causes the output voltage to change. The maximum possible positive value of the two data bytes indicates that the device should make the transition as quickly as possible.

**Data Length in Bytes:** 2

**Data Format:** L11

**Type:** R/W

**Default value:** BA00h (1V/ms)

**Units:** V/ms

**Range:** 0.1 to 4V/ms

**VOUT\_DROOP (28h)**

**Definition:** Sets the effective load line (V/I slope) for the rail in which the device is used. It is the rate, in mV/A, at which the output voltage decreases (or increases) with increasing (or decreasing) output current for use with adaptive voltage positioning schemes or multi-module current sharing. In current sharing configuration, VOUT\_DROOP set in each module stands for the droop seen by the load.

**Data Length in Bytes:** 2

**Data Format:** L11

**Type:** R/W

**Default value:** Pin-strap setting

**Units:** mV/A

**Range:** 0 to 40mV/A

**FREQUENCY\_SWITCH (33h)**

**Definition:** Sets the switching frequency of the device. The initial default value is defined by a pin-strap, and this value can be overridden by writing this command from the PMBus. If an external SYNC is used, this value should be set as close as possible to the external clock value. The output must be disabled when writing this command.

**Data Length in Bytes:** 2

**Data Format:** L11

**Type:** R/W

**Default Value:** Pin-strap setting

**Units:** kHz

**Range:** 300kHz to 1066kHz

**INTERLEAVE (37h)**

**Definition:** Configures the phase offset of a device that is sharing a common SYNC clock with other devices. The phase offset of each device can be set to any value between 0° and 360° in 22.5° increments.

**Data Length in Bytes:** 2

**Data Format:** BIT

**Type:** R/W

**Default Value:** 0000h

**Units:** N/A

BITS	PURPOSE	VALUE	DESCRIPTION
15:4	Reserved	0	Reserved
3:0	Position in Group	0 to 15	Sets position of the device's rail within the group.

**IOUT\_CAL\_GAIN (38h)**

**Definition:** Sets the effective impedance across the current sense circuit for use in calculating output current at +25°C.

**Data Length in Bytes:** 2

**Data Format:** L11

**Type:** R/W

**Default Value:** B370h (0.86mΩ)

**Units:** mΩ

**IOUT\_CAL\_OFFSET (39h)**

**Definition:** Nulls any offsets in the output current sensing circuit for each phase and compensates for delayed measurements of current ramp due to I<sub>SENSE</sub> blanking time.

**Data Length in Bytes:** 2

**Data Format:** L11

**Type:** R/W

**Default Value:** 0000h (0A)

**Units:** A

**VOUT\_OV\_FAULT\_LIMIT (40h)**

**Definition:** Sets the  $V_{OUT}$  overvoltage fault threshold.

**Data Length in Bytes:** 2

**Data Format:** L16u

**Type:** R/W

**Default Value:** 1.15xVOUT\_COMMAND pin-strap setting

**Units:** V

**Range:** 0V to VOUT\_MAX

**VOUT\_OV\_FAULT\_RESPONSE (41h)**

**Definition:** Configures the  $V_{OUT}$  overvoltage fault response. Note that the device cannot be set to ignore this fault mode.

**Data Length in Bytes:** 1

**Data Format:** BIT

**Type:** R/W

**Default Value:** 80h (Disable and no retry)

**Units:** N/A

BIT	FIELD NAME	VALUE	DESCRIPTION
7:6	Reserved	10	
5:3	Retry Setting	000	No retry. The output remains disabled until the fault is cleared.
		001-110	Not used.
		111	Attempts to restart continuously, without checking if the fault is still present, until it is commanded OFF (by the CONTROL pin or OPERATION command), bias power is removed, or another fault condition causes the unit to shut down.
2:0	Retry Delay	000-111	Retry delay time = (Value + 1)*35ms. Sets the time between retries in 35ms

**VOUT\_OV\_WARN\_LIMIT (42h)**

**Definition:** Sets the  $V_{OUT}$  overvoltage warning threshold. The power-good signal is pulled low when output voltage goes higher than this threshold.

**Data Length in Bytes:** 2

**Data Format:** L16u

**Type:** R/W

**Default Value:** 1.10xVOUT\_COMMAND pin-strap setting

**Units:** V

**Range:** 0V to VOUT\_MAX

**VOUT\_UV\_WARN\_LIMIT (43h)**

**Definition:** Sets the  $V_{OUT}$  undervoltage warning threshold. The power-good signal is pulled low when the output voltage goes lower than this threshold.

**Data Length in Bytes:** 2

**Data Format:** L16u

**Type:** R/W

**Default Value:** 0.90xVOUT\_COMMAND pin-strap setting

**Units:** V

**Range:** 0V to VOUT\_MAX

**VOUT\_UV\_FAULT\_LIMIT (44h)**

**Definition:** Sets the  $V_{OUT}$  undervoltage fault threshold. This fault is masked during ramp or when disabled.

**Data Length in Bytes:** 2

**Data Format:** L16u

**Type:** R/W

**Default Value:** 0.85xVOUT\_COMMAND pin-strap setting

**Units:** V

**Range:** 0V to VOUT\_MAX



**VOUT\_UV\_FAULT\_RESPONSE (45h)**

**Definition:** Configures the  $V_{OUT}$  undervoltage fault response.

**Data Length in Bytes:** 1

**Data Format:** BIT

**Type:** R/W

**Default Value:** 80h (Disable, no retry)

**Units:** N/A

BIT	FIELD NAME	VALUE	DESCRIPTION
7:6	Reserved	10	
5:3	Retry Setting	000	No retry. The output remains disabled until the fault is cleared.
		001-110	Not used.
		111	Attempts to restart continuously, without checking if the fault is still present, until it is commanded OFF (by the CONTROL pin or OPERATION command), bias power is removed, or another fault condition causes the unit to shut down.
2:0	Retry Delay	000-111	Retry delay time = (Value + 1)*35ms. Sets the time between retries in 35ms increments. Range is 35ms to 280ms.

**IOUT\_OC\_FAULT\_LIMIT (46h)**

**Definition:** Sets the  $I_{OUT}$  average overcurrent fault threshold. The device will automatically calculate peak inductor overcurrent fault limit for each phase based on the equation:  $I_{OUT}(PEAK\ OC\ LIMIT) = (0.5 * IOUT\_OC\_FAULT\_LIMIT + 0.5 * I_{RIPPLE(P-P)}) * 125\%$ . A hard bound of 60A is applied to the peak overcurrent fault limit per phase.

**Data Length in Bytes:** 2

**Data Format:** L11

**Type:** R/W

**Default Value:** EAD0h (90A)

**Units:** A

**Range:** -100A to 100A

**IOUT\_OC\_WARN\_LIMIT (4Ah)**

**Definition:** Sets the  $I_{OUT}$  average overcurrent warning threshold. This command is available only with the FC03 and FC04 firmware.

**Data Length in Bytes:** 2

**Data Format:** L11

**Type:** R/W

**Default Value:**  $0.90 * IOUT\_OC\_FAULT\_LIMIT$

**Units:** A

**Range:** -100A to 100A

**IOUT\_UC\_FAULT\_LIMIT (4Bh)**

**Definition:** Sets the  $I_{OUT}$  average undercurrent fault threshold. The device will automatically calculate the valley inductor undercurrent fault limit for each phase based on the equation:  $I_{OUT}(VALLEY\ UC\ LIMIT) = (0.5 * IOUT\_UC\_FAULT\_LIMIT - 0.5 * I_{RIPPLE(P-P)}) * 125\%$ . A hard bound of -55A is applied to the valley undercurrent fault limit per phase.

**Data Length in Bytes:** 2

**Data Format:** L11

**Type:** R/W

**Default Value:** E4E0h (-50A)

**Units:** A

**Range:** -100A to 100A

**OT\_FAULT\_LIMIT (4Fh)**

**Definition:** Sets the temperature at which the device should indicate an over-temperature fault. Note that the temperature must drop below the limit specified in OT\_WARN\_LIMIT to clear this fault.

**Data Length in Bytes:** 2

**Data Format:** L11

**Type:** R/W

**Default Value:** EBE8h (+125°C)

**Units:** Celsius

**Range:** 0°C to +175°C

**OT\_FAULT\_RESPONSE (50h)**

**Definition:** Instructs the device on what action to take in response to an over-temperature fault.

**Data Length in Bytes:** 1

**Data Format:** BIT

**Type:** R/W

**Fault Value:** 80h (Disable and no retry)

**Units:** N/A

BIT	FIELD NAME	VALUE	DESCRIPTION
7:6	Reserved	10	
5:3	Retry Setting	000	No retry. The output remains disabled until the fault is cleared.
		001-110	Not used.
		111	Attempts to restart continuously, without checking if the fault is still present, until it is commanded OFF (by the CONTROL pin or OPERATION command), bias power is removed, or another fault condition causes the unit to shut down.
2:0	Retry Delay	000-111	Retry delay time = (Value + 1)*35ms. Sets the time between retries in 35ms increments. Range is 35ms to 280ms.

**OT\_WARN\_LIMIT (51h)**

**Definition:** Sets the temperature at which the device should indicate an over-temperature warning alarm. In response to the OT\_WARN\_LIMIT being exceeded, the device sets the TEMPERATURE bit in STATUS\_WORD, sets the OT\_WARNING bit in STATUS\_TEMPERATURE, and notifies the host.

**Data Length in Bytes:** 2

**Data Format:** L11

**Type:** R/W

**Default Value:** EB48h (+105°C)

**Units:** Celsius

**Range:** 0°C to +175°C

**UT\_WARN\_LIMIT (52h)**

**Definition:** Sets the temperature at which the device should indicate an under-temperature warning alarm. In response to the UT\_WARN\_LIMIT being exceeded, the device sets the TEMPERATURE bit in STATUS\_WORD, sets the UT\_WARNING bit in STATUS\_TEMPERATURE, and notifies the host.

**Data Length in Bytes:** 2

**Data Format:** L11

**Type:** R/W

**Default Value:** DC40h (-30°C)

**Units:** Celsius

**Range:** -55°C to +25°C

**UT\_FAULT\_LIMIT (53h)**

**Definition:** Sets the temperature, in degrees Celsius, of the unit where it should indicate an under-temperature fault. Note that the temperature must rise above the limit specified in UT\_WARN\_LIMIT to clear this fault.

**Data Length in Bytes:** 2

**Data Format:** L11

**Type:** R/W

**Default Value:** E580h (-40 °C)

**Units:** Celsius

**Range:** -55 °C to +25 °C

**UT\_FAULT\_RESPONSE (54h)**

**Definition:** Configures the under-temperature fault response as defined by the following table. The delay time is the time between restart attempts.

**Data Length in Bytes:** 1

**Data Format:** BIT

**Type:** R/W

**Default Value:** 80h (Disable, no retry)

**Units:** N/A

BIT	FIELD NAME	VALUE	DESCRIPTION
7:6	Reserved	10	
5:3	Retry Setting	000	No retry. The output remains disabled until the fault is cleared.
		001-110	Not used.
		111	Attempts to restart continuously, without checking if the fault is still present, until it is commanded OFF (by the CONTROL pin or OPERATION command), bias power is removed, or another fault condition causes the unit to shut down.
2:0	Retry Delay	000-111	Retry delay time = (Value + 1)*35ms. Sets the time between retries in 35ms increments. Range is 35ms to 280ms.

**VIN\_OV\_FAULT\_LIMIT (55h)**

**Definition:** Sets the V<sub>IN</sub> overvoltage fault threshold.

**Data Length in Bytes:** 2

**Data Format:** L11

**Type:** R/W

**Default Value:** D380h (14V)

**Units:** V

**Range:** 0V to 16V

**VIN\_OV\_FAULT\_RESPONSE (56h)**

**Definition:** Configures the  $V_{IN}$  overvoltage fault response as defined by the following table. The delay time is the time between restart attempts.

**Data Length in Bytes:** 1

**Data Format:** BIT

**Type:** R/W

**Default Value:** 80h (Disable and no retry)

**Units:** N/A

BIT	FIELD NAME	VALUE	DESCRIPTION
7:6	Reserved	10	
5:3	Retry Setting	000	No retry. The output remains disabled until the fault is cleared.
		001-110	Not used.
		111	Attempts to restart continuously, without checking if the fault is still present, until it is commanded OFF (by the CONTROL pin or OPERATION command), bias power is removed, or another fault condition causes the unit to shut down.
2:0	Retry Delay	000-111	Retry delay time = (Value + 1)*35ms. Sets the time between retries in 35ms increments. Range is 35ms to 280ms.

**VIN\_OV\_WARN\_LIMIT (57h)**

**Definition:** Sets the VIN overvoltage warning threshold. In response to the OV\_WARN\_LIMIT being exceeded, the device sets the NONE OF THE ABOVE and INPUT bits in STATUS\_WORD, sets the VIN\_OV\_WARNING bit in STATUS\_INPUT, and notifies the host.

**Data Length in Bytes:** 2

**Data Format:** L11

**Type:** R/W

**Protectable:** Yes

**Default Value:** D353h (13.3V)

**Units:** V

**Range:** 0V to 16V

**VIN\_UV\_WARN\_LIMIT (58h)**

**Definition:** Sets the VIN undervoltage warning threshold. If a VIN\_UV\_FAULT occurs, the input voltage must rise above VIN\_UV\_WARN\_LIMIT to clear the fault, which provides hysteresis to the fault threshold. In response to the UV\_WARN\_LIMIT being exceeded, the device sets the NONE OF THE ABOVE and INPUT bits in STATUS\_WORD, sets the VIN\_UV\_WARNING bit in STATUS\_INPUT, and notifies the host.

**Data Length in Bytes:** 2

**Data Format:** L11

**Type:** R/W

**Default Value:** 1.05 x VIN\_UV\_FAULT\_LIMIT pin-strap setting

**Units:** V

**Range:** 0V to 12V

**VIN\_UV\_FAULT\_LIMIT (59h)**

**Definition:** Sets the  $V_{IN}$  undervoltage fault threshold.

**Data Length in Bytes:** 2

**Data Format:** L11

**Type:** R/W

**Default Value:** Pin-strap setting

**Units:** V

**Range:** 0V to 12V

## VIN\_UV\_FAULT\_RESPONSE (5Ah)

**Definition:** Configures the  $V_{IN}$  undervoltage fault response as defined by the following table. The delay time is the time between restart attempts.

**Data Length in Bytes:** 1

**Data Format:** BIT

**Type:** R/W

**Default Value:** 80h (Disable and no retry)

**Units:** N/A

BIT	FIELD NAME	VALUE	DESCRIPTION
7:6	Reserved	10	
5:3	Retry Setting	000	No retry. The output remains disabled until the fault is cleared.
		001-110	Not used.
		111	Attempts to restart continuously, without checking if the fault is still present, until it is commanded OFF (by the CONTROL pin or OPERATION command), bias power is removed, or another fault condition causes the unit to shut down.
2:0	Retry Delay	000-111	Retry delay time = (Value + 1)*35ms. Sets the time between retries in 35ms increments. Range is 35ms to 280ms.

## POWER\_GOOD\_ON (5Eh)

**Definition:** Sets the voltage threshold for Power-good indication. Power-good asserts with a delay specified in POWER\_GOOD\_DELAY after the output voltage exceeds POWER\_GOOD\_ON and deasserts when the output voltage is less than VOUT\_UV\_WARN\_LIMIT. It is recommended to set POWER\_GOOD\_ON higher than VOUT\_UV\_FAULT\_LIMIT.

**Data Length in Bytes:** 2

**Data Format:** L16u

**Type:** R/W

**Default Value:** 0.9xVOUT\_COMMAND pin-strap setting

**Units:** V

## TON\_DELAY (60h)

**Definition:** Sets the delay time from when the device is enabled to the start of  $V_{OUT}$  rise.

**Data Length in Bytes:** 2

**Data Format:** L11

**Type:** R/W

**Default Value:** Pin-strap setting

**Units:** ms

**Range:** 0 to 256ms

## TON\_RISE (61h)

**Definition:** Sets the rise time of  $V_{OUT}$  after ENABLE and TON\_DELAY. In multi-module current sharing configuration where ASCR is disabled for start up, the rise time of  $V_{OUT}$  can be approximately calculated by [Equation 1](#).

**Data Length in Bytes:** 2

**Data Format:** L11

**Type:** R/W

**Default Value:** Pin-strap setting

**Units:** ms

**Range:** 0 to 200ms

**TOFF\_DELAY (64h)**

**Definition:** Sets the delay time from DISABLE to start of  $V_{OUT}$  fall.

**Data Length in Bytes:** 2

**Data Format:** L11

**Type:** R/W

**Default Value:** Pin-strap setting

**Units:** ms

**Range:** 0 to 256ms

**TOFF\_FALL (65h)**

**Definition:** Sets the soft-off fall time for  $V_{OUT}$  after DISABLE and TOFF\_DELAY.

**Data Length in Bytes:** 2

**Data Format:** L11

**Type:** R/W

**Default Value:** Pin-strap setting

**Units:** ms

**Range:** 0 to 200ms

**STATUS\_BYTE (78h)**

**Definition:** Returns one byte of information with a summary of the most critical faults.

**Data Length in Bytes:** 1

**Data Format:** BIT

**Type:** Read-only

**Default Value:** 00h

**Units:** N/A

BIT NUMBER	STATUS BIT NAME	MEANING
7	BUSY	A fault was declared because the device was busy and unable to respond.
6	OFF	This bit is asserted if the unit is not providing power to the output, regardless of the reason, including simply not being enabled.
5	VOUT_OV_FAULT	An output overvoltage fault has occurred.
4	IOUT_OC_FAULT	An output overcurrent fault has occurred.
3	VIN_UV_FAULT	An input undervoltage fault has occurred.
2	TEMPERATURE	A temperature fault or warning has occurred.
1	CML	A communications, memory, or logic fault has occurred.
0	NONE OF THE ABOVE	A fault or warning not listed in bits 7:1 has occurred.

**STATUS\_WORD (79h)**

**Definition:** Returns two bytes of information with a summary of the unit's fault condition. Based on the information in these bytes, the host can get more information by reading the appropriate status registers. The low byte of the STATUS\_WORD is the same register as the STATUS\_BYTE (78h) command.

**Data Length in Bytes:** 2

**Data Format:** BIT

**Type:** Read-only

**Default Value:** 0000h

**Units:** N/A

BIT NUMBER	STATUS BIT NAME	MEANING
15	VOUT	An output voltage fault or warning has occurred.
14	IOUT/POUT	An output current or output power fault or warning has occurred.
13	INPUT	An input voltage, input current, or input power fault or warning has occurred.
12	MFG_SPECIFIC	A manufacturer specific fault or warning has occurred.
11	POWER_GOOD#	The POWER_GOOD signal, if present, is negated.
10	FANS	A fan or airflow fault or warning has occurred.
9	OTHER	A bit in STATUS_OTHER is set.
8	UNKNOWN	A fault type not given in bits 15:1 of the STATUS_WORD has been detected.
7	BUSY	A fault was declared because the device was busy and unable to respond.
6	OFF	This bit is asserted if the unit is not providing power to the output, regardless of the reason, including simply not being enabled.
5	VOUT_OV_FAULT	An output overvoltage fault has occurred.
4	IOUT_OC_FAULT	An output overcurrent fault has occurred.
3	VIN_UV_FAULT	An input undervoltage fault has occurred.
2	TEMPERATURE	A temperature fault or warning has occurred.
1	CML	A communications, memory, or logic fault has occurred.
0	NONE OF THE ABOVE	A fault or warning not listed in bits 7:1 has occurred.

**STATUS\_VOUT (7Ah)**

**Definition:** Returns one data byte with the status of the output voltage.

**Data Length in Bytes:** 1

**Data Format:** BIT

**Type:** Read-only

**Default Value:** 00h

**Units:** N/A

BIT NUMBER	STATUS BIT NAME	MEANING
7	VOUT_OV_FAULT	Indicates an output overvoltage fault.
6	VOUT_OV_WARNING	Indicates an output overvoltage warning.
5	VOUT_UV_WARNING	Indicates an output undervoltage warning.
4	VOUT_UV_FAULT	Indicates an output undervoltage fault.
3:0	N/A	These bits are not used.

**STATUS\_IOUT (7Bh)**

**Definition:** Returns one data byte with the status of the output current.

**Data Length in Bytes:** 1

**Data Format:** BIT

**Type:** Read-only

**Default Value:** 00h

**Units:** N/A

BIT NUMBER	STATUS BIT NAME	MEANING
7	IOUT_OC_FAULT	An output overcurrent fault has occurred.
6	IOUT_OC_LV_FAULT	An output overcurrent and low voltage fault has occurred.
5	IOUT_OC_WARNING	An output overcurrent warning has occurred.
4	IOUT_UC_FAULT	An output undercurrent fault has occurred.
3:0	N/A	These bits are not used.

**STATUS\_INPUT (7Ch)**

**Definition:** Returns the input voltage and input current status information.

**Data Length in Bytes:** 1

**Data Format:** BIT

**Type:** Read-only

**Default Value:** 00h

**Units:** N/A

BIT NUMBER	STATUS BIT NAME	MEANING
7	VIN_OV_FAULT	An input overvoltage fault has occurred.
6	VIN_OV_WARNING	An input overvoltage warning has occurred.
5	VIN_UV_WARNING	An input undervoltage warning has occurred.
4	VIN_UV_FAULT	An input undervoltage fault has occurred.
3:0	N/A	These bits are not used.



**STATUS\_TEMP (7Dh)**

**Definition:** Returns one byte of information with a summary of any temperature related faults or warnings.

**Data Length in Bytes:** 1

**Data Format:** BIT

**Type:** Read-only

**Default Value:** 00h

**Units:** N/A

BIT NUMBER	STATUS BIT NAME	MEANING
7	OT_FAULT	An over-temperature fault has occurred.
6	OT_WARNING	An over-temperature warning has occurred.
5	UT_WARNING	An under-temperature warning has occurred.
4	UT_FAULT	An under-temperature fault has occurred.
3:0	N/A	These bits are not used.

**STATUS\_CML (7Eh)**

**Definition:** Returns one byte of information with a summary of any communications, logic, and/or memory errors.

**Data Length in Bytes:** 1

**Data Format:** BIT

**Type:** Read-only

**Default Value:** 00h

**Units:** N/A

BIT NUMBER	MEANING
7	Invalid or unsupported PMBus command was received.
6	The PMBus command was sent with invalid or unsupported data.
5	Packet error was detected in the PMBus command.
4:2	Not used
1	A PMBus command tried to write to a read-only or protected command, or a communication fault other than the ones listed in this table has occurred.
0	Not used

**STATUS\_MFR\_SPECIFIC (80h)**

**Definition:** Returns one byte of information providing the status of the device's voltage monitoring and clock synchronization faults. VMON OV/UV warnings are set at  $\pm 10\%$  of the VMON\_FAULT commands.

**Data Length in Bytes:** 1

**Data Format:** BIT

**Type:** Read only

**Default value:** 00h

**Units:** N/A

BIT NUMBER	FIELD NAME	MEANING
7:6	Reserved	
5	VMON UV Warning	For FC01 firmware: the voltage on the VMON pin has dropped below 4V. For FC03 and FC04 firmware: the voltage on the VMON pin has dropped below 4.4V.
4	VMON OV Warning	For FC01 firmware: the voltage on the VMON pin has risen above 6V. For FC03 firmware: the voltage on the VMON pin has risen above 5.6V. For FC04 firmware: the voltage on the VMON pin has risen above 5.9V.
3	External Switching Period Fault	Loss of external clock synchronization has occurred.
2	Reserved	
1	VMON UV Fault	The voltage on the VMON pin has dropped below the level set by VMON_UV_FAULT_LIMIT.
0	VMON OV Fault	The voltage on the VMON pin has risen above the level set by VMON_OV_FAULT_LIMIT.

**READ\_VIN (88h)**

**Definition:** Returns the input voltage reading.

**Data Length in Bytes:** 2

**Data Format:** L11

**Type:** Read-only

**Units:** V

**READ\_VOUT (8Bh)**

**Definition:** Returns the output voltage reading.

**Data Length in Bytes:** 2

**Data Format:** L16u

**Type:** Read-only

**Units:** V

**READ\_IOUT (8Ch)**

**Definition:** Returns the output current reading.

**Data Length in Bytes:** 2

**Data Format:** L11

**Type:** Read-only

**Default Value:** N/A

**Units:** A

**READ\_INTERNAL\_TEMP (8Dh)**

**Definition:** Returns the controller junction temperature reading from internal temperature sensor. Note that the junction temperature of the power stage in the module may be higher than the READ\_INTERNAL\_TEMP command value, and the temperature difference depends on the operating condition. In some cases, the power stage junction temperature can be 30°C higher than the READ\_INTERNAL\_TEMP command value.

**Data Length in Bytes:** 2

**Data Format:** L11

**Type:** Read-only

**Units:** °C

**READ\_DUTY\_CYCLE (94h)**

**Definition:** Reports the actual duty cycle of the converter during the enable state.

**Data Length in Bytes:** 2

**Data Format:** L11

**Type:** Read only

**Units:** %

**READ\_FREQUENCY (95h)**

**Definition:** Reports the actual switching frequency of the converter during the enable state.

**Data Length in Bytes:** 2

**Data Format:** L11

**Type:** Read only

**Units:** kHz

**READ\_IOUT\_0 (96h)**

**Definition:** Returns the Phase 1 current reading.

**Data Length in Bytes:** 2

**Data Format:** L11

**Type:** Read-only

**Default Value:** N/A

**Units:** A

---

## READ\_IOUT\_1 (97h)

**Definition:** Returns the Phase 2 current reading.

**Data Length in Bytes:** 2

**Data Format:** L11

**Type:** Read-only

**Default Value:** N/A

**Units:** A

## MFR\_ID (99h)

**Definition:** Sets user defined identification. The sum total of characters in MFR\_ID, MFR\_MODEL, MFR\_REVISION, MFR\_LOCATION, MFR\_DATE, MFR\_SERIAL, and USER\_DATA\_00 plus one byte per command cannot exceed 128 characters. This limitation includes multiple writes of this command before a STORE command. To clear multiple writes, perform a RESTORE, write this command, and perform a STORE/RESTORE.

**Data Length in Bytes:** user defined

**Data Format:** ASC

**Type:** Block R/W

**Default Value:** null

**Units:** N/A

## MFR\_MODEL (9Ah)

**Definition:** Sets a user defined model. The sum total of characters in MFR\_ID, MFR\_MODEL, MFR\_REVISION, MFR\_LOCATION, MFR\_DATE, MFR\_SERIAL, and USER\_DATA\_00 plus one byte per command cannot exceed 128 characters. This limitation includes multiple writes of this command before a STORE command. To clear multiple writes, perform a RESTORE, write this command, and perform a STORE/RESTORE.

**Data Length in Bytes:** user defined

**Data Format:** ASC

**Type:** Block R/W

**Default Value:** null

**Units:** N/A

## MFR\_REVISION (9Bh)

**Definition:** Sets a user defined revision. The sum total of characters in MFR\_ID, MFR\_MODEL, MFR\_REVISION, MFR\_LOCATION, MFR\_DATE, MFR\_SERIAL, and USER\_DATA\_00 plus one byte per command cannot exceed 128 characters. This limitation includes multiple writes of this command before a STORE command. To clear multiple writes, perform a RESTORE, write this command, and perform a STORE/RESTORE.

**Data Length in Bytes:** user defined

**Data Format:** ASC

**Type:** Block R/W

**Default Value:** null

**Units:** N/A

## MFR\_LOCATION (9Ch)

**Definition:** Sets a user defined location identifier. The sum total of characters in MFR\_ID, MFR\_MODEL, MFR\_REVISION, MFR\_LOCATION, MFR\_DATE, MFR\_SERIAL, and USER\_DATA\_00 plus one byte per command cannot exceed 128 characters. This limitation includes multiple writes of this command before a STORE command. To clear multiple writes, perform a RESTORE, write this command, and perform a STORE/RESTORE.

**Data Length in Bytes:** user defined

**Data Format:** ASC

**Type:** Block R/W

**Default Value:** null

**Units:** N/A

---

### **MFR\_DATE (9Dh)**

**Definition:** Sets a user defined date. The sum total of characters in MFR\_ID, MFR\_MODEL, MFR\_REVISION, MFR\_LOCATION, MFR\_DATE, MFR\_SERIAL, and USER\_DATA\_00 plus one byte per command cannot exceed 128 characters. This limitation includes multiple writes of this command before a STORE command. To clear multiple writes, perform a RESTORE, write this command, and perform a STORE/RESTORE.

**Data Length in Bytes:** user defined

**Data Format:** ASC

**Type:** Block R/W

**Default Value:** null

**Units:** N/A

**Reference:** N/A

### **MFR\_SERIAL (9Eh)**

**Definition:** Sets a user defined serialized identifier. The sum total of characters in MFR\_ID, MFR\_MODEL, MFR\_REVISION, MFR\_LOCATION, MFR\_DATE, MFR\_SERIAL, and USER\_DATA\_00 plus one byte per command cannot exceed 128 characters. This limitation includes multiple writes of this command before a STORE command. To clear multiple writes, perform a RESTORE, write this command, and perform a STORE/RESTORE.

**Data Length in Bytes:** user defined

**Data Format:** ASC

**Type:** Block R/W

**Default Value:** null

**Units:** N/A

### **LEGACY\_FAULT\_GROUP (A8h)**

**Definition:** Sets which rail DDC IDs should be listened to for fault spreading with legacy devices. The data sent is a 4-byte, 32-bit, bit vector where every bit represents a rail's DDC ID. A bit set to 1 indicates a device DDC ID to which the configured device will respond upon receiving a fault spreading event. In this vector, Bit 0 of byte 0 corresponds to the rail with DDC ID 0. Following through, Bit 7 of byte 3 corresponds to the rail with DDC ID 31.

**Data Length in Bytes:** 4

**Data Format:** BIT

**Type:** Block R/W

**Default Value:** 00000000h (No rail ID specified)

### **USER\_DATA\_00 (B0h)**

**Definition:** Sets a user defined data. The sum total of characters in MFR\_ID, MFR\_MODEL, MFR\_REVISION, MFR\_LOCATION, MFR\_DATE, MFR\_SERIAL, and USER\_DATA\_00 plus one byte per command cannot exceed 128 characters. This limitation includes multiple writes of this command before a STORE command. To clear multiple writes, perform a RESTORE, write this command, and perform a STORE/RESTORE.

**Data Length in Bytes:** user defined

**Data Format:** ASC

**Type:** Block R/W

**Default Value:** null

**Units:** N/A

**ISENSE\_CONFIG (D0h)****Definition:** Configures current sense circuitry.**Data Length in Bytes:** 1**Data Format:** BIT**Type:** R/W**Default Value:** 06h (256ns current sense blanking time, current sense high range)**Units:** N/A

BIT	FIELD NAME	VALUE	SETTING	DESCRIPTION
7:4	Reserved	0000		
3:2	Current Sense Blanking Time	00	192ns	Sets the blanking time current sense blanking time.
		01	256ns	
		10	412ns	
		11	640ns	
1:0	Current Sense Range	00	Low Range	±25mV
		01	Mid Range	±35mV
		10	High Range	±50mV
		11	Not Used	

**USER\_CONFIG (D1h)****Definition:** Configures several user-level features. This command overrides the pin-strap settings.**Data Length in Bytes:** 1**Data Format:** BIT**Type:** R/W**Default Value:** Pin-strap setting for ASCR on for Start up; ramp-up and ramp-down minimum duty cycle 0.39%; minimum duty cycle control enabled; PG is open-drain output.**Units:** N/A

BIT	FIELD NAME	VALUE	SETTING	DESCRIPTION
7	ASCR on for Start up	0	Disabled	ASCR is disabled for start up. Use this for current sharing mode.
		1	Enabled	ASCR is enabled for start up. Use this for stand alone mode.
6:5	Reserved	0		Reserved
4:3	Ramp-up and Ramp-down Minimum Duty Cycle	00	0.39%	Sets the minimum duty-cycle during start-up and shutdown ramp.
		01	0.78%	
		10	1.17%	
		11	1.56%	
2	Minimum Duty Cycle Control	0	Disable	Control for minimum duty cycle.
		1	Enable	
1	Power-good Pin Configuration	0	Open Drain	0 = PG is open-drain output.
		1	Push-Pull	1 = PG is push-pull output.
0	Reserved	0		

**DDC\_CONFIG (D3h)**

**Definition:** Configures DDC addressing and current sharing. With pin-strap for stand alone configuration, the DDC rail ID is set according to the SMBus address. With pin-strap for multi-module current sharing, the DDC rail ID is set according to the number of devices. Device position and number of devices in the rail can be programmed as needed.

**Data Length in Bytes:** 2

**Data Format:** BIT

**Type:** R/W

**Default Value:** Pin-strap setting

**Units:** N/A

BIT	FIELD NAME	VALUE	SETTING	DESCRIPTION
15:13	Device Position	0, 1, 2, 3		Sets the device position in a current sharing rail. 0-Position 1; 1-Position 2; 2-Position 3; 3-Position 4
12:8	Rail ID	0 to 31 (00 to 1Fh)		Configures DDC rail ID
7:4	Reserved	0	Reserved	Reserved
3	Device Internal Phase Difference	0, 1		Sets the internal phase difference of the device. 0-phase difference is 180°; 1-phase difference is 0°.
2:0	Number of Devices in Rail	1, 3, 5, 7		Identifies the number of devices in a current sharing rail. 1-stand-alone; 3-two devices; 5-three devices; 7-four devices

**POWER\_GOOD\_DELAY (D4h)**

**Definition:** Sets the delay applied between the output exceeding the PG threshold (POWER\_GOOD\_ON) and asserting the PG pin. The delay time can range from 0ms up to 500s, in steps of 125ns. A 1ms minimum configured value is recommended to apply proper debounce to this signal.

**Data Length in Bytes:** 2

**Data Format:** L11

**Type:** R/W

**Default Value:** C300h, 3ms

**Units:** ms

**Range:** 0 to 5s

**ASCR\_CONFIG (DFh)**

**Definition:** Allows user configuration of ASCR settings. ASCR gain is analogous to bandwidth and ASCR residual is analogous to damping. To improve load transient response performance, increase ASCR gain. To lower transient response overshoot, increase ASCR residual. Increasing ASCR gain can result in increased PWM jitter and should be evaluated in the application circuit. Excessive ASCR gain can lead to excessive output voltage ripple. Increasing ASCR residual to improve transient response damping can result in slower recovery times, but will not affect the peak output voltage deviation. Typical ASCR gain settings range from 50 to 1000, and ASCR residual settings range from 10 to 100.

**Data Length in Bytes:** 4

**Data Format:** CUS

**Type:** R/W

**Default Value:** Pin-strap setting

BIT	PURPOSE	DATA Format	VALUE	DESCRIPTION
31:25	Unused		0000000h	Unused
24	ASCR Enable	BIT	1	Enable
			0	Disable
23:16	ASCR Residual Setting	Integer		ASCR residual
15:0	ASCR Gain Setting	Integer		ASCR gain

## SEQUENCE (E0h)

**Definition:** Identifies the Rail DDC ID of the prequel and sequel rails when performing multi-rail sequencing. The device will enable its output when its EN or OPERATION enable states, as defined by ON\_OFF\_CONFIG, is set and the prequel device has issued a Power-good event on the DDC bus. The device will disable its output (using the programmed delay values) when the sequel device has issued a Power-down event on the DDC bus.

The data field is a two-byte value. The most significant byte contains the 5-bit Rail DDC ID of the prequel device. The least-significant byte contains the 5-bit Rail DDC ID of the sequel device. The most significant bit of each byte contains the enable of the prequel or sequel mode. This command overrides the corresponding sequence configuration set by the CONFIG pin settings.

**Data Length in Bytes:** 2

**Data Format:** BIT

**Type:** R/W

**Default Value:** 0000h (Prequel and Sequel disabled)

BIT	FIELD NAME	VALUE	SETTING	DESCRIPTION
15	Prequel Enable	0	Disable	Disable, no prequel preceding this rail.
		1	Enable	Enable, prequel to this rail is defined by bits 12:8.
14:13	Reserved	0	Reserved	Reserved
12:8	Prequel Rail DDC ID	0-31	DDC ID	Set to the DDC ID of the prequel rail.
7	Sequel Enable	0	Disable	Disable, no sequel following this rail.
		1	Enable	Enable, sequel to this rail is defined by bits 4:0.
6:5	Reserved	0	Reserved	Reserved
4:0	Sequel Rail DDC ID	0-31	DDC ID	Set to the DDC ID of the sequel rail.

## DDC\_GROUP (E2h)

**Definition:** Configures fault spreading group ID and enable, broadcast OPERATION group ID and enable, and broadcast VOUT\_COMMAND group ID and enable.

**Data Length in Bytes:** 3

**Data Format:** BIT

**Type:** Block R/W

**Default Value:** Pin-strap setting (Ignore BROADCAST VOUT\_COMMAND, OPERATION, and fault for stand-alone operation. Enable BROADCAST VOUT\_COMMAND, OPERATION, and fault for current sharing)

BITS	PURPOSE	VALUE	DESCRIPTION
23:22	Reserved	0	Reserved
21	BROADCAST_VOUT_COMMAND Response	1	Responds to BROADCAST_VOUT_COMMAND with same Group ID.
		0	Ignores BROADCAST_VOUT_COMMAND.
20:16	BROADCAST_VOUT_COMMAND Group ID	0-31d	Group ID sent as data for broadcast BROADCAST_VOUT_COMMAND events.
15:14	Reserved	0	Reserved
13	BROADCAST_OPERATION Response	1	Responds to BROADCAST_OPERATION with same Group ID.
		0	Ignores BROADCAST_OPERATION.
12:8	BROADCAST_OPERATION Group ID	0-31d	Group ID sent as data for broadcast BROADCAST_OPERATION events.
7:6	Reserved	0	Reserved
5	POWER_FAIL Response	1	Responds to POWER_FAIL events with same Group ID by shutting down immediately.
		0	Responds to POWER_FAIL events with same Group ID with sequenced shutdown.
4:0	POWER_FAIL group ID	0-31d	Group ID sent as data for broadcast POWER_FAIL events.

**DEVICE\_ID (E4h)**

**Definition:** Returns the 16-byte (character) device identifier string.

**Data Length in Bytes:** 16

**Data Format:** ASC

**Type:** Block Read

**Default Value:** Part number/Die revision/Firmware revision

**MFR\_IOUT\_OC\_FAULT\_RESPONSE (E5h)**

**Definition:** Configures the I<sub>OUT</sub> overcurrent fault response as defined by the following table. The command format is the same as the PMBus standard fault responses except that it sets the overcurrent status bit in STATUS\_IOUT.

**Data Length in Bytes:** 1

**Data Format:** BIT

**Type:** R/W

**Default Value:** 80h (Disable, and no retry)

**Units:** N/A

BIT	FIELD NAME	VALUE	DESCRIPTION
7:6	Reserved	10	
5:3	Retry Setting	000	No retry. The output remains disabled until the fault is cleared.
		001-110	Not used.
		111	Attempts to restart continuously, without checking if the fault is still present, until it is commanded OFF (by the CONTROL pin or OPERATION command), bias power is removed, or another fault condition causes the unit to shut down.
2:0	Retry Delay	000-111	Retry delay time = (Value + 1)*35ms. Sets the time between retries in 35ms increments. Range is 35ms to 280ms.

**MFR\_IOUT\_UC\_FAULT\_RESPONSE (E6h)**

**Definition:** Configures the I<sub>OUT</sub> undercurrent fault response as defined by the following table. The command format is the same as the PMBus standard fault responses except that it sets the undercurrent status bit in STATUS\_IOUT.

**Data Length in Bytes:** 1

**Data Format:** BIT

**Type:** R/W

**Default Value:** 80h (Disable and no retry)

**Units:** N/A

BIT	FIELD NAME	VALUE	DESCRIPTION
7:6	Reserved	10	
5:3	Retry Setting	000	No retry. The output remains disabled until the fault is cleared.
		001-110	Not used.
		111	Attempts to restart continuously, without checking if the fault is still present, until it is commanded OFF (by the CONTROL pin or OPERATION command), bias power is removed, or another fault condition causes the unit to shut down.
2:0	Retry Delay	000-111	Retry delay time = (Value + 1)*35ms. Sets the time between retries in 35ms increments. Range is 35ms to 280ms.



**SYNC\_CONFIG (E9h)**

**Definition:** Sets options for SYNC output configurations.

**Data Length in Bytes:** 1

**Data Format:** BIT

**Type:** R/W

**Default Value:** Pin-strap setting

SETTINGS	ACTIONS
00h	Use internal clock. Clock frequency is set by pin-strap or PMBus command.
02h	Use internal clock and output internal clock.
04h	Use external clock.

**SNAPSHOT (EAh)**

**Definition:** 32-byte read-back of parametric and status values. It allows monitoring and status data to be stored to flash following a fault condition. In case of a fault, last updated values are stored to the flash memory. When the SNAPSHOT STATUS bit is set to stored, the device will no longer automatically capture parametric and status values following fault until stored data are erased. Use SNAPSHOT\_CONTROL command to erase store data and clear the status bit before next ramp up. Data erase is not allowed when the module is enabled.

**Data Length in Bytes:** 32

**Data Format:** Bit field

**Type:** Block Read

BYTE NUMBER	VALUE	PMBUS COMMAND	FORMAT
31:23	Reserved	Reserved	00h
22	Flash Memory Status Byte FF - Not Stored 00 - Stored	N/A	BIT
21	Manufacturer Specific Status Byte	STATUS_MFR_SPECIFIC (80h)	Byte
20	CML Status Byte	STATUS_CML (7Eh)	Byte
19	Temperature Status Byte	STATUS_TEMPERATURE (7Dh)	Byte
18	Input Status Byte	STATUS_INPUT (7Ch)	Byte
17	I <sub>OUT</sub> Status Byte	STATUS_IOUT (7Bh)	Byte
16	V <sub>OUT</sub> Status Byte	STATUS_VOUT (7Ah)	Byte
15:14	Switching Frequency	READ_FREQUENCY (95h)	L11
13:12	Reserved	Reserved	00h
11:10	Internal Temperature	READ_INTERNAL_TEMP (8Dh)	L11
9:8	Duty Cycle	READ_DUTY_CYCLE (94h)	L11
7:6	Highest Measured Output Current	N/A	L11
5:4	Output Current	READ_IOUT (8Ch)	L11
3:2	Output Voltage	READ_VOUT (8Bh)	L16u
1:0	Input Voltage	READ_VIN (88h)	L11

**BLANK\_PARAMS (EBh)**

**Definition:** Returns a 16-byte string indicating which parameter values were either retrieved by the last RESTORE operation or have been written since that time. Reading BLANK\_PARAMS immediately after a restore operation allows the user to determine which parameters are stored in that store. A one indicates the parameter is not present in the store and has not been written since the RESTORE operation.

**Data Length in Bytes:** 16

**Data Format:** BIT

**Type:** Block Read

**Default Value:** FF...FFh

### SNAPSHOT\_CONTROL (F3h)

**Definition:** Writing a 01h will cause the device to copy the current Snapshot values from NVRAM to the 32-byte Snapshot command parameter. Writing a 02h will cause the device to write the current Snapshot values to NVRAM, 03h will erase all Snapshot values from NVRAM. Write (02h) and Erase (03h) can be used only when the device is disabled. All other values will be ignored.

**Data Length in Bytes:** 1

**Data Format:** Bit field

**Type:** R/W byte

VALUE	DESCRIPTION
01h	Read Snapshot values from NV RAM
02h	Write Snapshot values to NV RAM
03h	Erase Snapshot values stored in NV RAM.

### RESTORE\_FACTORY (F4h)

**Definition:** Restores the device to the hard coded factory default values and pin-strap definitions. The device retains the DEFAULT and USER stores for restoring. Security level is changed to Level 1 following this command.

**Data Length in Bytes:** 0

**Data Format:** N/A

**Type:** Send byte

**Default Value:** N/A

**Units:** N/A

### MFR\_VMON\_OV\_FAULT\_LIMIT (F5h)

**Definition:** Reads the VMON OV fault threshold.

**Data Length in Bytes:** 2

**Data Format:** L11

**Type:** Read only

**Default Value:** CB00h (6V)

**Units:** V

**Range:** 4V to 6V

### MFR\_VMON\_UV\_FAULT\_LIMIT (F6h)

**Definition:** Reads the VMON UV fault threshold

**Data Length in Bytes:** 2

**Data Format:** L11

**Type:** Read only

**Default Value:** CA00h (4V)

**Units:** V

**Range:** 4V to 6V

### MFR\_READ\_VMON (F7h)

**Definition:** Reads the VMON voltage.

**Data Length in Bytes:** 2

**Data Format:** L11

**Type:** Read only

**Default Value:** N/A

**Units:** V

**Range:** 4V to 6V

**VMON\_OV\_FAULT\_RESPONSE (F8h)****Definition:** Reads the VMON OV fault response**Data Length in Bytes:** 1**Data Format:** BIT**Type:** Read only**Default Value:** 80h (Disable and no retry)**Units:** N/A**VMON\_UV\_FAULT\_RESPONSE (F9h)****Definition:** Reads the VMON UV fault response, which is a direct copy of VIN\_UV\_FAULT\_RESPONSE**Data Length in Bytes:** 1**Data Format:** BIT**Type:** Read only**Default Value:** 80h (Disable and no retry)**Units:** V

**Datasheet Revision History** The revision history provided is for informational purposes only and is believed to be accurate, but not warranted. Visit the website to make sure you have the latest revision.

DATE	REVISION	CHANGE
Nov 9, 2017	FN8704.4	<ul style="list-style-type: none"> <li>- Added ISL8273MDIRZ to Ordering Information on page 3.</li> <li>- Added FC04 to firmware revision graphic on page 3.</li> <li>- Updated Pin Configuration graphic on page 3.</li> <li>- Updated Table 3 on page 16 with FC04-specific values.</li> <li>- Updated Table 9 on page 21 with information about FC03 and FC04.</li> <li>- Updated IOUT_OC_WARN_LIMIT (4Ah) descriptions on pages 25 and 33.</li> <li>- Updated STATUS_MFR_SPECIFIC description on page 41.</li> <li>- Updated READ_INTERNAL_TEMP description on page 42.</li> <li>- Added FC04 to Firmware Revision History on page 53.</li> </ul>
May 9, 2017	FN8704.3	<ul style="list-style-type: none"> <li>- Updated the Ordering Information table on page 3 by adding part number ISL8273MCIRZ.</li> <li>- Added a nomenclature guide on page 3.</li> <li>- Added Notes 1 and 2 on page 3.</li> <li>- Removed STORE_DEFAULT_ALL and RESTORE_DEFAULT_ALL commands from PMBus guidelines</li> <li>- Added and edited descriptions which pertain to changes made in FC03 firmware from FC01/FC02 firmware</li> <li>1) Added command IOUT_OC_WARN_LIMIT</li> <li>2) Added to Table 9 Current Sharing Resistor Settings based on FC03 firmware changes</li> <li>3) Updated description for PMBus command DDC_CONFIG(D3h) and description for Phase Spreading.</li> <li>- Added in SMBus Communications the requirement for pin-strap resistor to have 1% tolerance or better</li> <li>- Updated Table 1 ISL8273M design guide matrix and output voltage response for the condition of VIN=5V, VOUT=1V, FREQ=300kHz</li> <li>-Updated the Firmware Revision History section.</li> <li>-POD Y58.18x23 updated from rev 1 to rev 3. Changes since rev 1: <ul style="list-style-type: none"> <li>1) Pages 1 and 2 of POD Y58.18x23 remain unchanged for this update.</li> <li>2) Delete remaining pages 3-5 of existing POD and replace with new pages 3-12. New drawings - 2 drawings per page - POD is now 7 pages.</li> <li>3) On -page 2, In "SIZE DETAILS FOR THE 16 EXPOSED PADS" (BOTTOM VIEW) changed dimension 8.40 (2X) to 8.30 (2x) and 8.00 (2x) to 1.00 (2X).</li> </ul> </li> </ul>
March 16, 2016	FN8704.2	<ul style="list-style-type: none"> <li>Added "PMBus Use Guidelines" on page 28.</li> <li>Updated POD Y58.18x23 to the latest revision changes are as follows: <ul style="list-style-type: none"> <li>-Detail A on page 1: Added Reference Radius for rounded corners on small I/O pads.</li> </ul> </li> </ul>
September 10, 2015	FN8704.1	<ul style="list-style-type: none"> <li>-Updated text on page 1.</li> <li>-Added a paragraph under "Soft-Start, Stop Delay, and Ramp Times" on page 16 to explain the internal start-up procedure after power is applied to the VDD pin.</li> <li>-Updated command description for VOUT_COMMAND, "This command cannot set a value higher than VOUT_MAX."</li> <li>-Updated the range for commands TON_DELAY and TOFF_DELAY on page 38 to "0ms to 256ms".</li> </ul>
June 11, 2015	FN8704.0	Initial Release

## Firmware Revision History

TABLE 10. ISL8273M NOMENCLATURE GUIDE

FIRMWARE REVISION CODE	CHANGE DESCRIPTION	NOTE
ISL8273-000-FC04	<ul style="list-style-type: none"> <li>- Changed VMON OV warning limit to 5.9V</li> <li>- Enhanced current balance between the two internal phases</li> <li>- Added three values for VSET pin-strap: 0.72V, 0.88V, and 0.92V</li> </ul>	Recommended for new designs
ISL8273-000-FC03	<ul style="list-style-type: none"> <li>- Enhanced fault management during start-up.</li> <li>- Enhanced IOUT UC fault management during start-up.</li> <li>- Enhanced PMBus immunity to noise and lockup.</li> <li>- Added IOUT_OC_WARN_LIMIT command.</li> <li>- Added the IOUT_OC_WARNING function bit in the STATUS_IOUT command.</li> <li>- Added paged ISENGain and ISENOffset factors which are storable in default memory.</li> <li>- Added temperature compensation for the paged ISENGain and ISENOffset factors and reduced temperature drift.</li> <li>- Improved intra-device current balance within the two internal phases.</li> <li>- Fixed the synchronization issue during VOUT_COMMAND change on-the-fly in current sharing conditions.</li> <li>- Added more pin-strap resistor settings for CS pin for four-module current sharing conditions.</li> <li>- Added the capability to change the device internal phase difference from 180° to 0° in DDC_CONFIG and optimized module-to-module phase shift in Current Sharing mode.</li> <li>- Changed VMON OV warning limit to 5.6V and VMON UV warning limit to 4.4V</li> </ul>	Not recommended for new designs
ISL8273-000-FC02	Skip	Not recommended for new designs
ISL8273-000-FC01	Initial Release	Not recommended for new designs

## About Intersil

Intersil Corporation is a leading provider of innovative power management and precision analog solutions. The company's products address some of the largest markets within the industrial and infrastructure, mobile computing and high-end consumer markets.

For the most updated datasheet, application notes, related documentation and related parts, please see the respective product information page found at [www.intersil.com](http://www.intersil.com).

For a listing of definitions and abbreviations of common terms used in our documents, visit [www.intersil.com/glossary](http://www.intersil.com/glossary).

You can report errors or suggestions for improving this datasheet by visiting [www.intersil.com/ask](http://www.intersil.com/ask).

Reliability reports are also available from our website at [www.intersil.com/support](http://www.intersil.com/support).

© Copyright Intersil Americas LLC 2015-2017. All Rights Reserved.

All trademarks and registered trademarks are the property of their respective owners.

For additional products, see [www.intersil.com/en/products.html](http://www.intersil.com/en/products.html)

Intersil products are manufactured, assembled and tested utilizing ISO9001 quality systems as noted in the quality certifications found at [www.intersil.com/en/support/qualandreliability.html](http://www.intersil.com/en/support/qualandreliability.html)

*Intersil products are sold by description only. Intersil may modify the circuit design and/or specifications of products at any time without notice, provided that such modification does not, in Intersil's sole judgment, affect the form, fit or function of the product. Accordingly, the reader is cautioned to verify that datasheets are current before placing orders. Information furnished by Intersil is believed to be accurate and reliable. However, no responsibility is assumed by Intersil or its subsidiaries for its use; nor for any infringements of patents or other rights of third parties which may result from its use. No license is granted by implication or otherwise under any patent or patent rights of Intersil or its subsidiaries.*

For information regarding Intersil Corporation and its products, see [www.intersil.com](http://www.intersil.com)

# Package Outline Drawing

## Y58.18x23

58 I/O 18mmx23mmx7.5mm CUSTOM HDA MODULE  
Rev 3, 12/16

For the most recent package outli

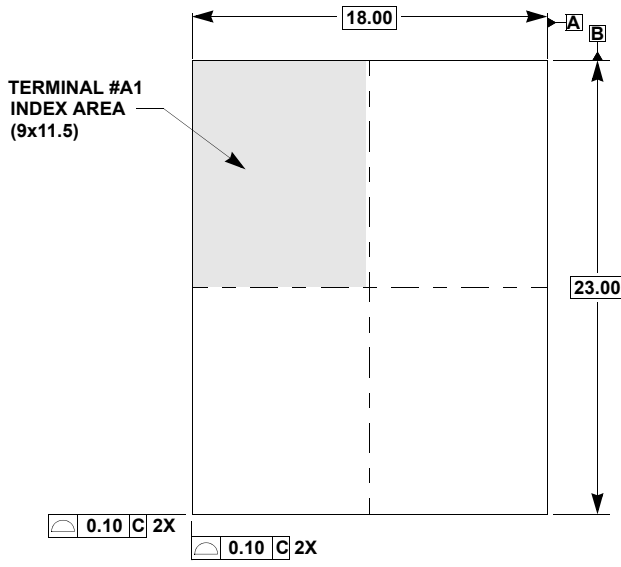

TOP VIEW

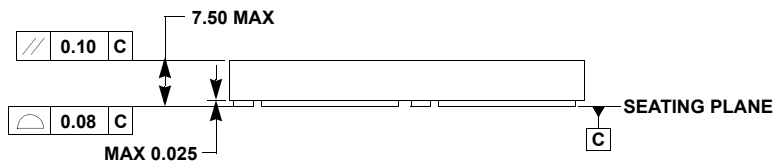

SIDE VIEW

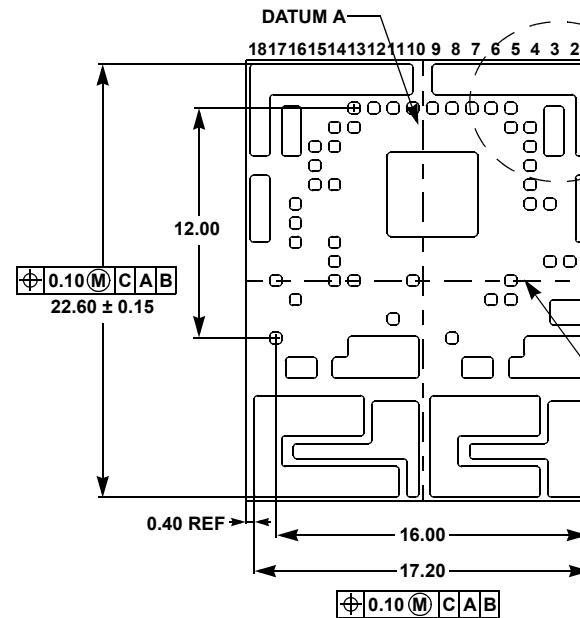

BOTTOM VIEW

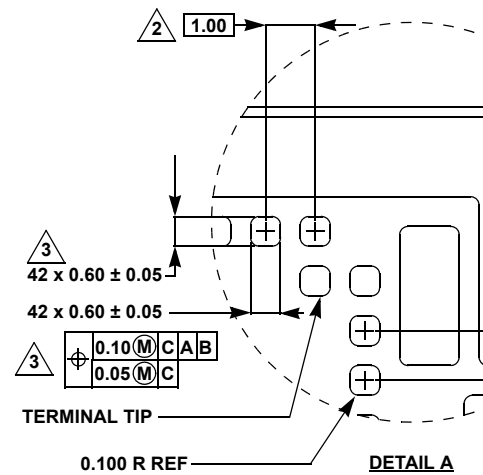

NOTES:

1. All dimensions are in millimeters.
- ② Represents the basic land grid pitch.
- ③ These 42 I/Os are centered in a fixed row and column matrix at 1.0mm pitch BSC.
4. Dimensioning and tolerancing per ASME Y14.5-2009.
5. Tolerance for exposed PAD edge location dimension on page 3 is ±0.1mm.

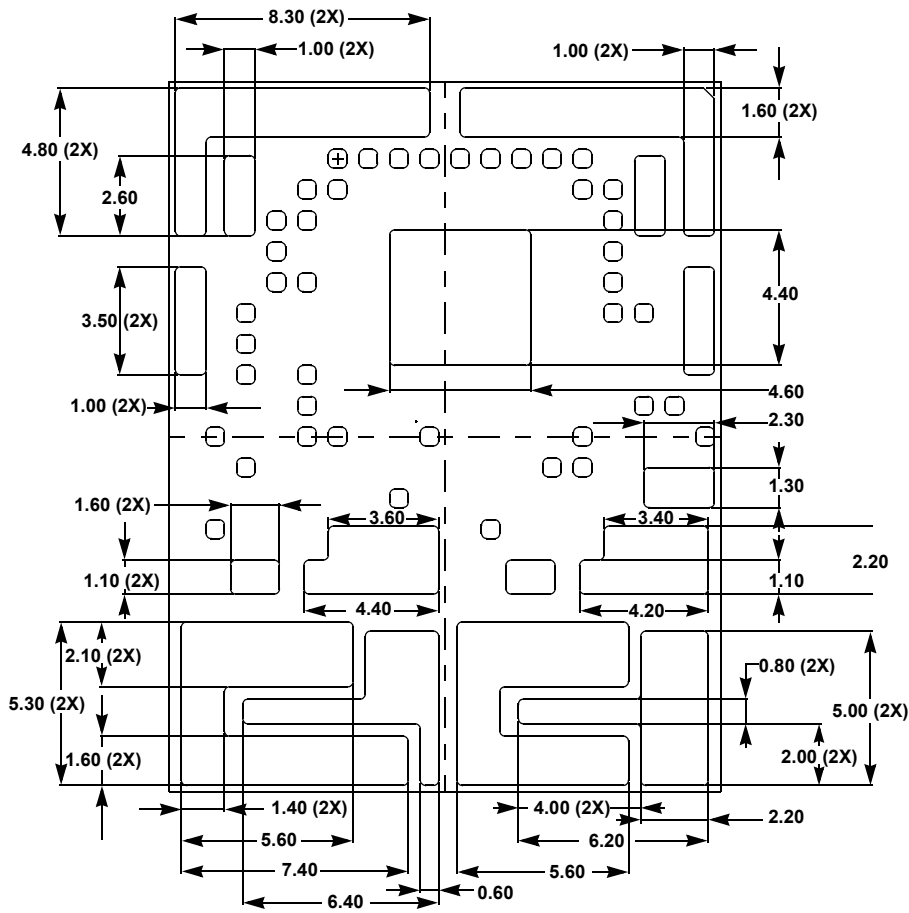

SIZE DETAILS FOR THE 16 EXPOSED PADS

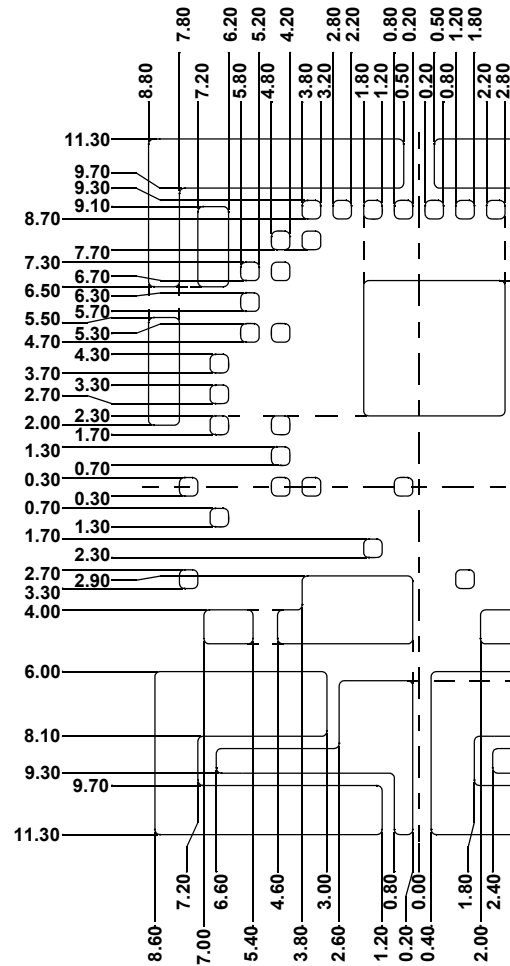

TERMINAL AND PAD EDGE DIMENSIONS

BOTTOM VIEW

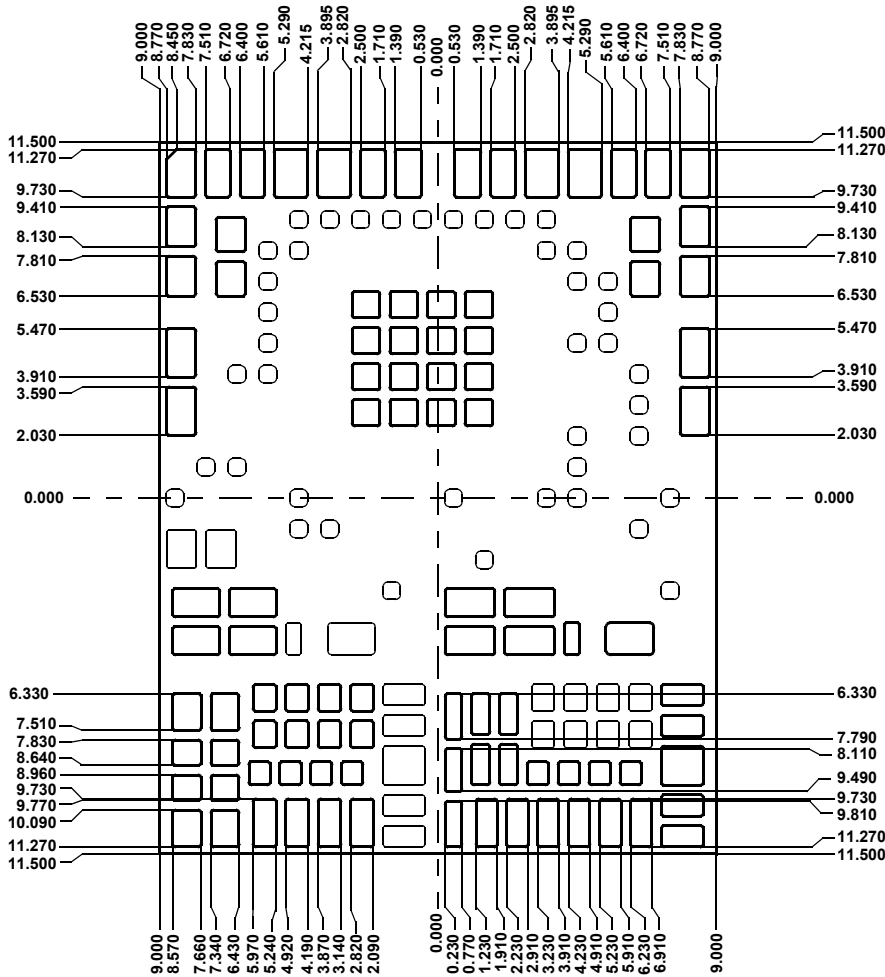

STENCIL OPENING EDGE POSITION - 1

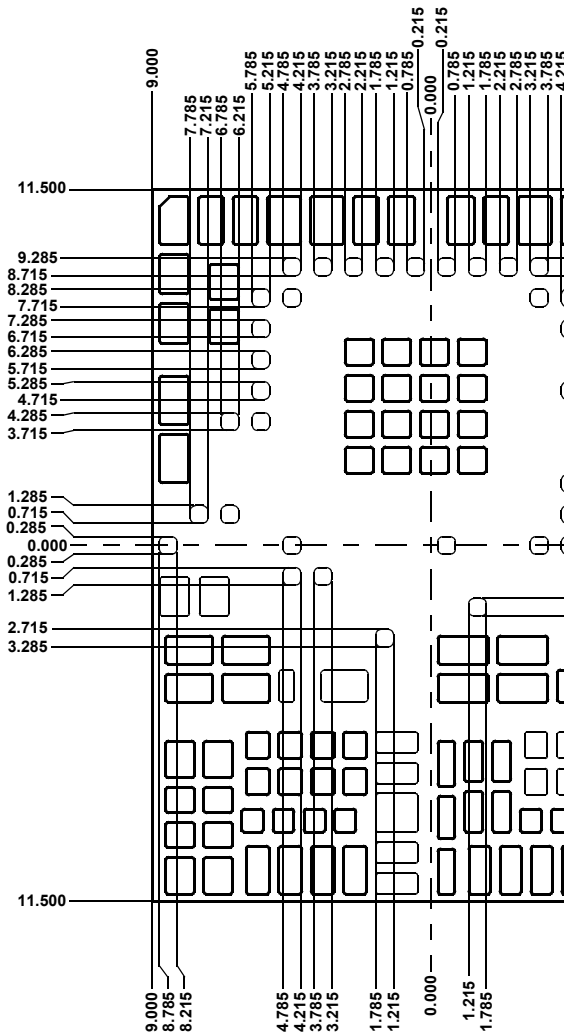

STENCIL OPENING EDGE POSITION





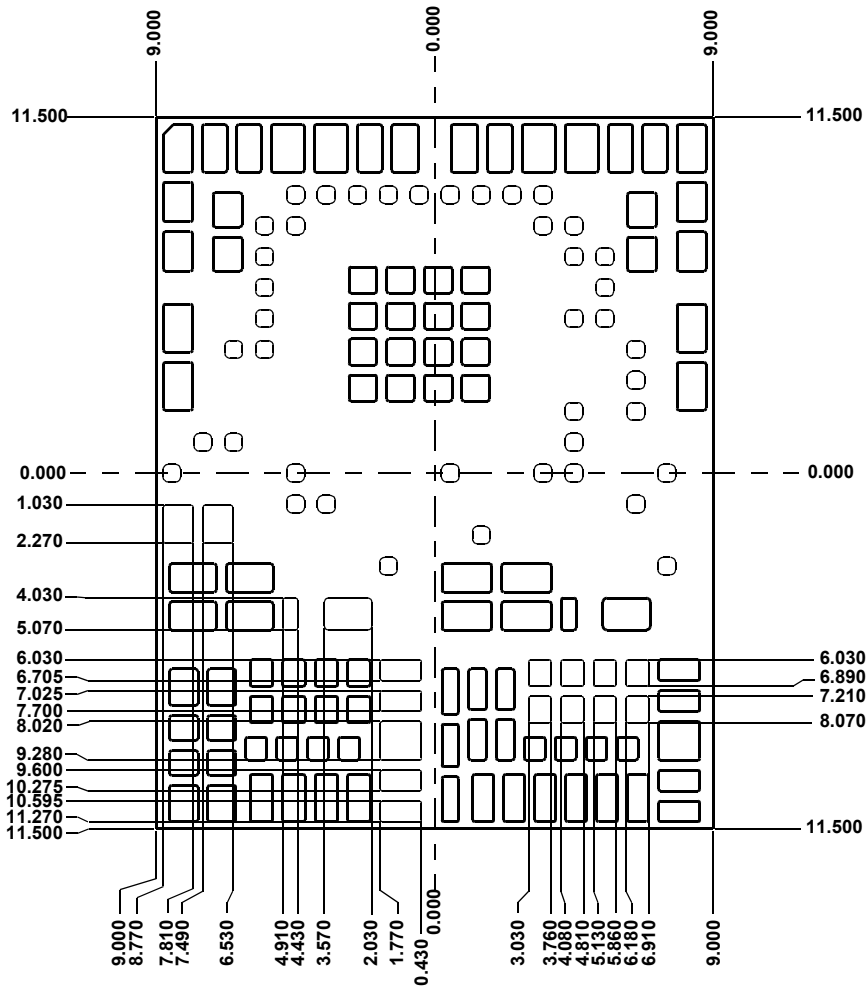

STENCIL OPENING EDGE POSITION - 5

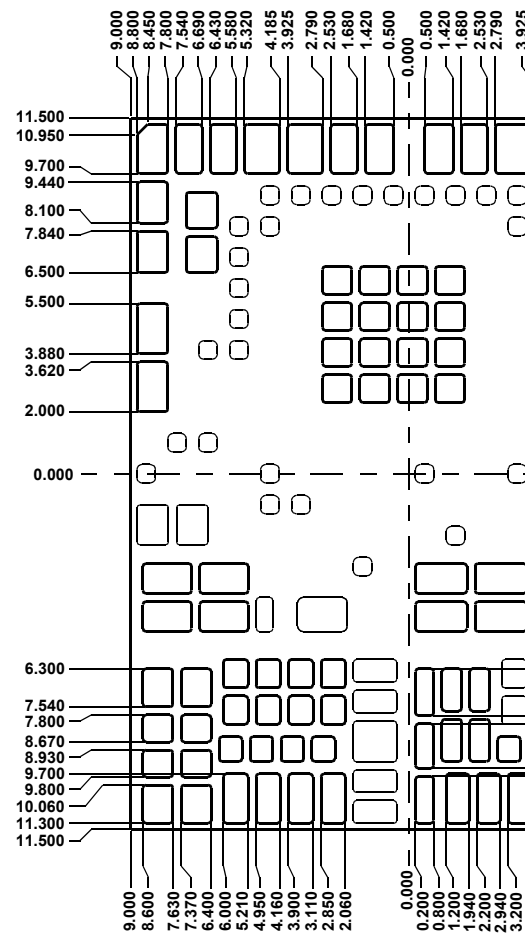

PCB LAND PATTERN - 1 (FOR REF)

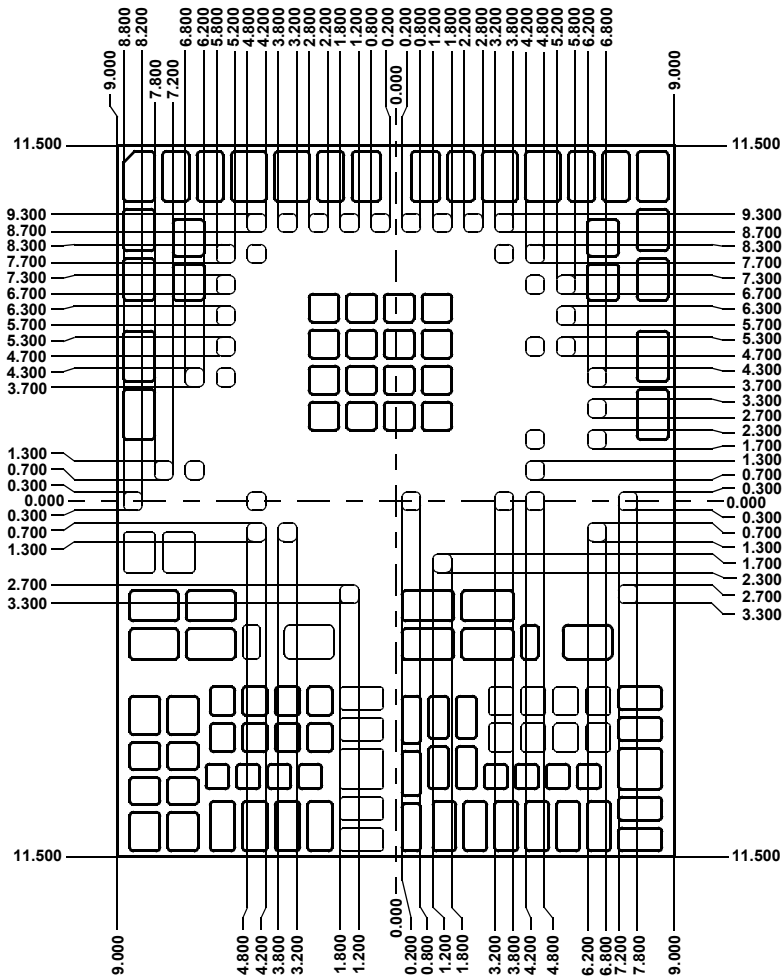

**PCB LAND PATTERN - 2 (FOR REFERENCE)**

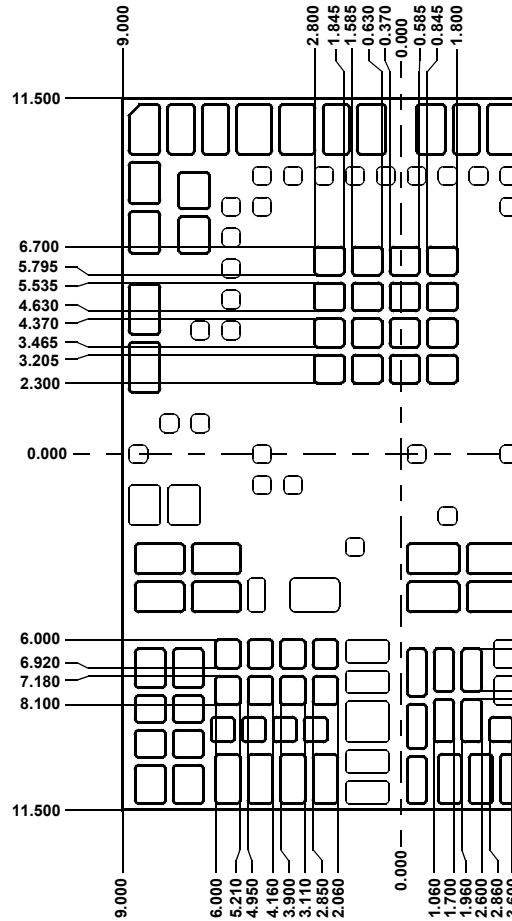

**PCB LAND PATTERN - 3 (FOR REFERENCE)**

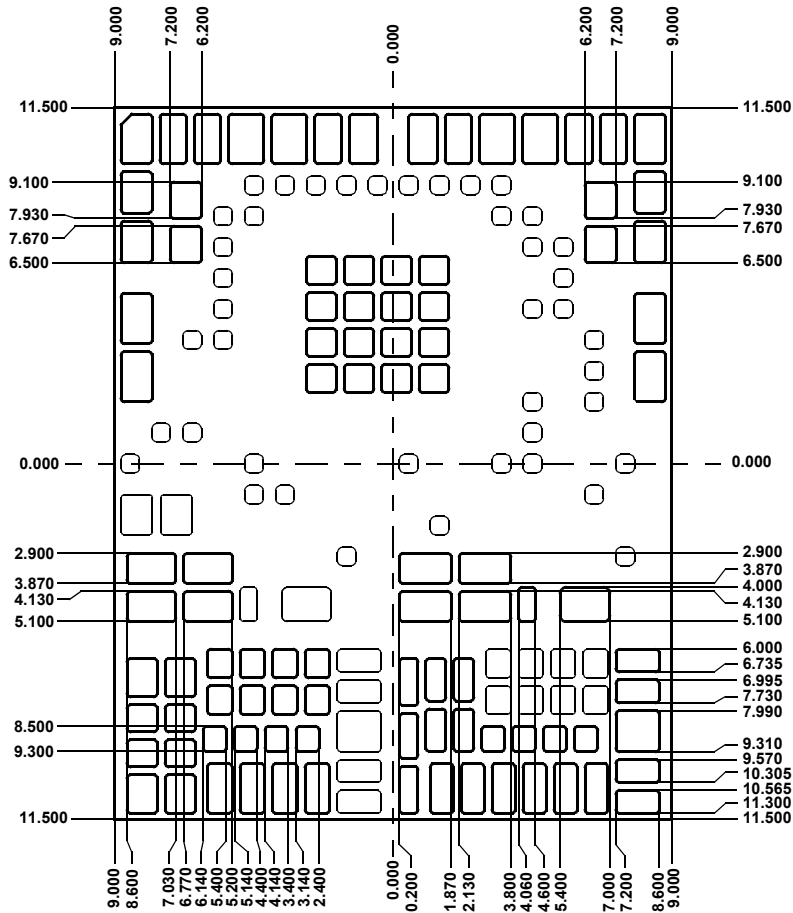

PCB LAND PATTERN - 4 (FOR REFERENCE)

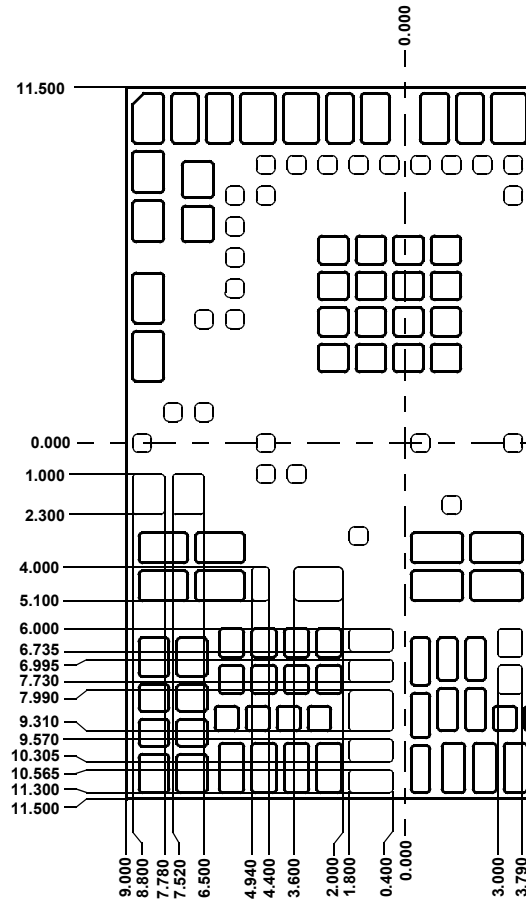

PCB LAND PATTERN - 5 (FOR REFERENCE)

## X-ON Electronics

Largest Supplier of Electrical and Electronic Components

*Click to view similar products for [Voltage Regulators - Switching Regulators](#) category:*

*Click to view products by [Renesas](#) manufacturer:*

Other Similar products are found below :

[LX7186A](#) [622616F](#) [632259F](#) [MP2148GQD-33-P](#) [MP2374DS-LF-Z](#) [EN6310QA](#) [L79M05TL-E](#) [FAN48610BUC45X](#) [R3](#) [430464BB](#)  
[455605G](#) [MIC4930YFL-T5](#) [KE177614](#) [418569H](#) [455596X](#) [511087D](#) [030908C](#) [063375FB](#) [067501FB](#) [099508GB](#) [EP5358LUA](#)  
[NCP81102MNTXG](#) [715715H](#) [FAN48611UC53X](#) [FAN53611AUC12X](#) [MAX809TTR](#) [MAX77596ETBC+T](#) [MAX16905AUE/V+](#)  
[NCP6332CMTAATBG](#) [LX7176A](#) [MP2162AGQH-Z](#) [MAX17544ATP+T](#) [MCP1623T-IMC](#) [MCP1642B-18IMC](#) [MCP1642BT-30I/MS](#)  
[MCP1642D-50IMC](#) [MCP1642D-50IMS](#) [MCP1642D-ADJIMC](#) [MC34063LBBGEVB](#) [MCP1252T-33X50IMS](#) [MCP1259-EMF](#) [MCP1602-](#)  
[250IMF](#) [MCP1640CT-IMC](#) [MCP1642B-30IMC](#) [MCP1642B-50IMC](#) [MCP1642B-50IMS](#) [MCP1642B-ADJIMC](#) [MCP1642D-18IMC](#)  
[MCP1642D-30IMC](#) [MCP1642D-33IMS](#)