

ISL83202

55V, 1A Peak Current H-Bridge FET Driver

FN6382

Rev.0.00

December 20, 2006

The ISL83202 is a medium-frequency H-Bridge FET driver capable of 1A (typ) of peak drive current that is designed to drive high- and low-side N-Channel MOSFETs in medium-voltage applications. Optimized for PWM motor control and uninterruptible power supply systems, the ISL83202 enables simple and flexible bridge-based design. With typical input-to-output propagation delays as low as 25ns and with a user-programmable dead-time range of 0.1µs to 4.5µs, the ISL83202 is ideal for switching frequencies up to 200kHz.

The dead-time of the ISL83202 is programmable via a single resistor. The ISL83202's four independent driver control inputs (ALI, AHI, BLI, and BHI) allow driving of every possible switch combination except those that would cause a shoot-through condition. A global disable input, DIS, overrides input control and causes the ISL83202 to refresh the bootstrap capacitor when pulled low. Integrated undervoltage protection and shoot-through protection ensure reliable system operation.

The ISL83202 is available in compact 16 Ld SOIC and 16 Ld PDIP packages and operates over the range of -55°C to +125°C.

Ordering Information

PART NUMBER	PART MARKING	TEMP. RANGE (°C)	PACKAGE	PKG. DWG. #
ISL83202IBZ (Note)	83202IBZ	-55 to +125	16 Ld SOIC (N) (Pb-free)	M16.15
ISL83202IBZT (Note)	16 Ld SOIC (N) Tape and Reel (Pb-free)			M16.15
ISL83202IPZ (Note)	ISL83202IPZ	-55 to +125	16 Ld PDIP** (Pb-free)	E16.3

NOTE: Intersil Pb-free plus anneal products employ special Pb-free material sets; molding compounds/die attach materials and 100% matte tin plate termination finish, which are RoHS compliant and compatible with both SnPb and Pb-free soldering operations. Intersil Pb-free products are MSL classified at Pb-free peak reflow temperatures that meet or exceed the Pb-free requirements of IPC/JEDEC J STD-020.

**Pb-free PDIPs can be used for through hole wave solder processing only. They are not intended for use in Reflow solder processing applications.

Features

- Independently Drives 4 N-Channel FETs in Half Bridge or Full Bridge Configurations
- Bootstrap Supply Max Voltage: 70VDC
- Drives a 1000pF Load in Free Air at +50°C with Rise and Fall Times of 15ns (typ)
- User-Programmable Dead Time from 0.1 to 4.5µs
- DIS (Disable) Overrides Input Control and Refreshes Bootstrap Capacitor when Pulled Low
- Input Logic Thresholds Compatible with 5V to 15V Logic Levels
- Shoot-Through Protection
- Undervoltage Protection
- Pb-Free Plus Anneal Available (RoHS Compliant)

Applications

- UPS Systems
- DC Motor Controls
- Full Bridge Power Supplies
- Switching Power Amplifiers
- Noise Cancellation Systems
- Battery Powered Vehicles
- Peripherals
- Medium/Large Voice Coil Motors
- Related Literature
 - TB363, Guidelines for Handling and Processing Moisture Sensitive Surface Mount Devices (SMDs)

Pinout

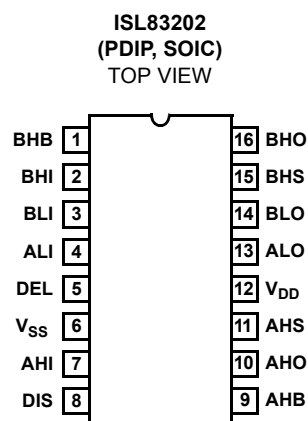

Application Block Diagram

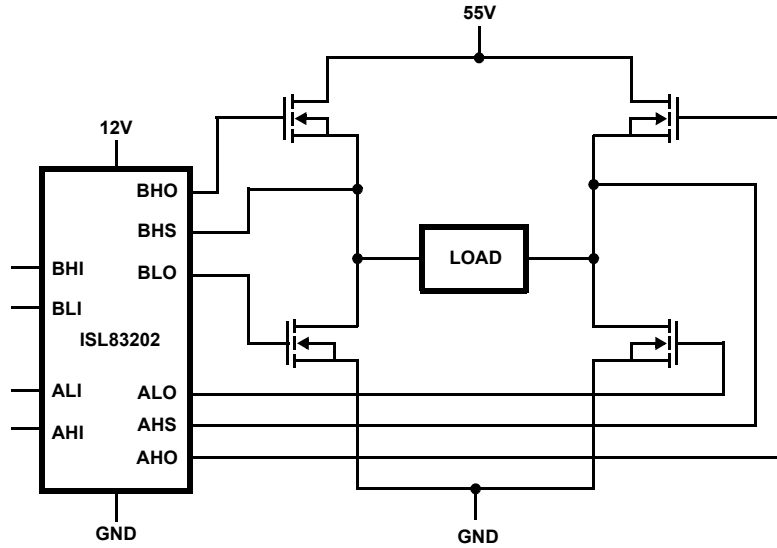

Functional Block Diagram

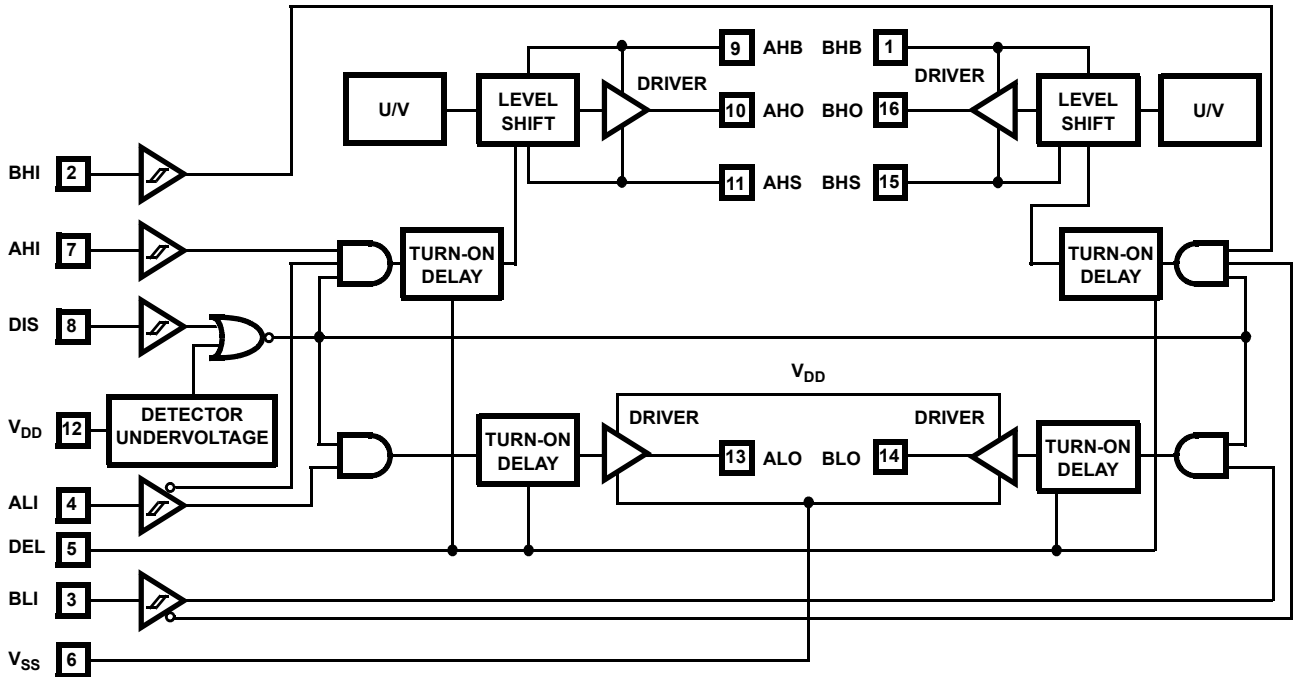

Typical Application (PWM Mode Switching)

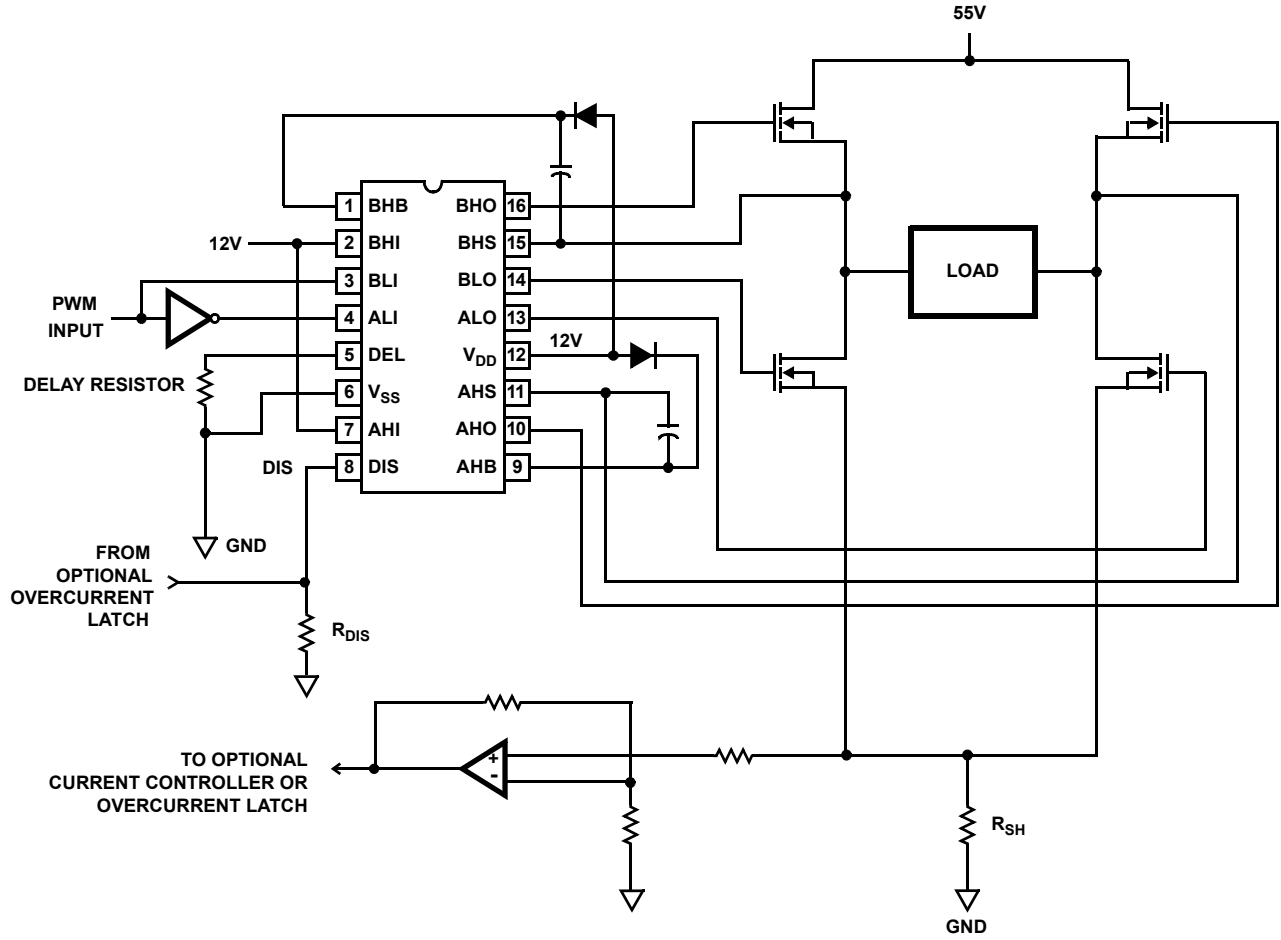

Absolute Maximum Ratings

Supply Voltage, V_{DD} -0.3V to 16V
 Logic I/O Voltages -0.3V to $V_{DD} + 0.3V$
 Voltage on AHS, BHS -6V (Transient) to 65V (-55°C to +150°C)
 Voltage on AHB, BHB $V_{AHS, BHS} - 0.3V$ to $V_{AHS, BHS} + V_{DD}$
 Voltage on ALO, BLO $V_{SS} - 0.3V$ to $V_{DD} + 0.3V$
 Voltage on AHO, BHO $V_{AHS, BHS} - 0.3V$ to $V_{AHB, BHB} + 0.3V$
 Input Current, DEL -5mA to 0mA
 Phase Slew Rate 20V/ns
 NOTE: All voltages are relative V_{SS} unless otherwise specified.

Operating Conditions

Supply Voltage, V_{DD} +8.5V to +15V
 Voltage on V_{SS} -1.0V to +1.0V
 Voltage on AHB, BHB -1V to +55V
 Voltage on AHB, BHB $V_{AHS, BHS} + 7.5V$ to $V_{AHS, BHS} + V_{DD}$
 Input Current, DEL -4mA to -100 μ A

CAUTION: Stresses above those listed in "Absolute Maximum Ratings" may cause permanent damage to the device. This is a stress only rating and operation of the device at these or any other conditions above those indicated in the operational sections of this specification is not implied.

+150°C max junction temperature is intended for short periods of time to prevent shortening the lifetime. Operation close to +150°C junction may trigger the shutdown of the device even before +150°C, since this number is specified as typical.

Thermal Information

Thermal Resistance θ_{JA} (°C/W)
 SOIC Package 115
 PDIP Package* 90
 Maximum Power Dissipation See Curve
 Storage Temperature Range -65°C to +150°C
 Operating Max. Junction Temperature +150°C
 Lead Temperature (Soldering 10s) +300°C
 (For SOIC - Lead Tips Only)

*Pb-free PDIPs can be used for through hole wave solder processing only. They are not intended for use in Reflow solder processing applications.

Electrical Specifications $V_{DD} = V_{AHB} = V_{BHB} = 12V$, $V_{SS} = V_{AHS} = V_{BHS} = 0V$, $R_{DEL} = 100k$

PARAMETER	SYMBOL	TEST CONDITIONS	$T_J = +25^\circ\text{C}$			$T_J = -55^\circ\text{C}$ TO $+150^\circ\text{C}$		UNITS
			MIN	TYP	MAX	MIN	MAX	
SUPPLY CURRENTS AND UNDER VOLTAGE PROTECTION								
V_{DD} Quiescent Current	I_{DD}	All inputs = 0V, $R_{DEL} = 100k$	1.2	2.3	3.5	0.85	4	mA
		All inputs = 0V, $R_{DEL} = 10k$	2.2	4.0	5.5	1.9	6.0	mA
V_{DD} Operating Current	I_{DDO}	f = 50kHz, no load	1.5	2.6	4.0	1.1	4.2	mA
		50kHz, no load, $R_{DEL} = 10k\Omega$	2.5	4.0	6.4	2.1	6.6	mA
AHB, BHB Off Quiescent Current	I_{AHBL} , I_{BHBL}	AHI = BHI = 0V	0.5	1.0	1.5	0.4	1.6	mA
AHB, BHB On Quiescent Current	I_{AHBH} , I_{BHBH}	AHI = BHI = V_{DD}	65	145	240	40	250	μ A
AHB, BHB Operating Current	I_{AHBO} , I_{BHBO}	f = 50kHz, CL = 1000pF	.65	1.1	1.8	.45	2.0	mA
AHS, BHS Leakage Current	I_{HLK}	$V_{AHS} = V_{BHS} = 55V$ $V_{AHB} = V_{BHB} = 70V$ $V_{DD} = \text{Not Connected}$	-	-	1.0	-	-	μ A
V_{DD} Rising Undervoltage Threshold	V_{DDUV+}		6.8	7.6	8.25	6.5	8.5	V
V_{DD} Falling Undervoltage Threshold	V_{DDUV-}		6.5	7.1	7.8	6.25	8.1	V
Undervoltage Hysteresis	UVHYS		0.17	0.4	0.75	0.15	0.90	V
AHB, BHB Undervoltage Threshold	VHBUV	Referenced to AHS and BHS	5	6.0	7	4.5	7.5	V
INPUT PINS: ALI, BLI, AHI, BHI, and DIS								
Low Level Input Voltage	V_{IL}	Full Operating Conditions	-	-	1.0	-	0.8	V
High Level Input Voltage	V_{IH}	Full Operating Conditions	2.5	-	-	2.7		V
Input Voltage Hysteresis			-	35	-	-	-	mV
Low Level Input Current	I_{IL}	$V_{IN} = 0V$, Full Operating Conditions	-145	-100	-60	-150	-50	μ A
High Level Input Current	I_{IH}	$V_{IN} = 5V$, Full Operating Conditions	-1	-	+1	-10	+10	μ A
TURN-ON DELAY PIN DEL								
Dead Time	T_{DEAD}	$R_{DEL} = 100k$	2.5	4.5	8.0	2.0	8.5	μ s
		$R_{DEL} = 10k$	0.27	0.5	0.75	0.2	0.85	μ s

Electrical Specifications $V_{DD} = V_{AHB} = V_{BHB} = 12V$, $V_{SS} = V_{AHS} = V_{BHS} = 0V$, $R_{DEL} = 100k$ (Continued)

PARAMETER	SYMBOL	TEST CONDITIONS	$T_J = +25^\circ C$			$T_J = -55^\circ C$ TO $+150^\circ C$		UNITS
			MIN	TYP	MAX	MIN	MAX	
GATE DRIVER OUTPUT PINS: ALO, BLO, AHO, and BHO								
Low Level Output Voltage	V_{OL}	$I_{OUT} = 50mA$	0.65		1.1	0.5	1.2	V
High Level Output Voltage	$V_{DD}-V_{OH}$	$I_{OUT} = -50mA$	0.7		1.2	0.5	1.3	V
Peak Pullup Current	I_{O+}	$V_{OUT} = 0V$		1.0		0.6	2.0	A
Peak Pulldown Current	I_{O-}	$V_{OUT} = 12V$		1.0		0.6	2.0	A

Switching Specifications $V_{DD} = V_{AHB} = V_{BHB} = 12V$, $V_{SS} = V_{AHS} = V_{BHS} = 0V$, $R_{DEL} = 100k$, $C_L = 1000pF$.

PARAMETER	SYMBOL	TEST CONDITIONS	$T_J = +25^\circ C$			$T_J = -55^\circ C$ TO $+150^\circ C$		UNITS
			MIN	TYP	MAX	MIN	MAX	
Lower Turn-off Propagation Delay (ALI-ALO, BLI-BLO)	T_{LPHL}		-	25	50	-	70	ns
Upper Turn-off Propagation Delay (AHI-AHO, BHI-BHO)	T_{HPHL}		-	55	80	-	100	ns
Lower Turn-on Propagation Delay (ALI-ALO, BLI-BLO)	T_{LPLH}		-	40	85	-	100	ns
Upper Turn-on Propagation Delay (AHI-AHO, BHI-BHO)	T_{HPLH}		-	75	110	-	150	ns
Rise Time	T_R		-	9	20	-	25	ns
Fall Time	T_F		-	9	20	-	25	ns
Minimum Input Pulse Width	$T_{PWIN-ON/OFF}$		50	-	-	50	-	ns
Output Pulse Response to 50ns Input Pulse	T_{PWOUT}			63			80	ns
Disable Turn-off Propagation Delay (DIS - Lower Outputs)	T_{DISLOW}		-	50	80	-	90	ns
Disable Turn-off Propagation Delay (DIS - Upper Outputs)	$T_{DISHIGH}$		-	75	100	-	125	ns
Disable Turn-on Propagation Delay (DIS - ALO and BLO)	T_{DLPLH}		-	40	70	-	100	ns
Disable Turn-on Propagation Delay (DIS- AHO and BHO)	T_{DHPLH}	$R_{DEL} = 10k$	-	1.2	2	-	3	μs
Refresh Pulse Width (ALO and BLO)	T_{REF-PW}		375	580	900	350	950	ns

TRUTH TABLE

INPUT					OUTPUT	
ALI, BLI	AHI, BHI	VDDUV	VHBUV	DIS	ALO, BLO	AHO, BHO
X	X	X	X	1	0	0
X	X	1	X	X	0	0
0	X	0	1	0	0	0
1	X	0	X	0	1	0
0	1	0	0	0	0	1
0	0	0	0	0	0	0

NOTE: X signifies that input can be either a "1" or "0".

Pin Descriptions

PIN NUMBER	SYMBOL	DESCRIPTION
1	BHB	B High-side Bootstrap supply. External bootstrap diode and capacitor are required. Connect cathode of bootstrap diode and positive side of bootstrap capacitor to this pin.
2	BHI	B High-side Input. Logic level input that controls BHO driver (Pin 16). BLI (Pin 3) high level input overrides BHI high level input to prevent half-bridge shoot-through, see Truth Table. DIS (Pin 8) high level input overrides BHI high level input. The pin can be driven by signal levels of 0V to 15V (no greater than V_{DD}).
3	BLI	B Low-side Input. Logic level input that controls BLO driver (Pin 14). If BHI (Pin 2) is driven high or not connected externally then BLI controls both BLO and BHO drivers, with dead time set by delay currents at DEL (Pin 5). DIS (Pin 8) high level input overrides BLI high level input. The pin can be driven by signal levels of 0V to 15V (no greater than V_{DD}).
4	ALI	A Low-side Input. Logic level input that controls ALO driver (Pin 13). If AHI (Pin 7) is driven high or not connected externally then ALI controls both ALO and AHO drivers, with dead time set by delay currents at DEL (Pin 5). DIS (Pin 8) high level input overrides ALI high level input. The pin can be driven by signal levels of 0V to 15V (no greater than V_{DD}).
5	DEL	Turn-on DELay. Connect resistor from this pin to V_{SS} to set timing current that defines the dead time between drivers. All drivers turn-off with no adjustable delay, so the DEL resistor guarantees no shoot-through by delaying the turn-on of all drivers. The voltage across the DEL resistor is approximately $V_{DD} - 2V$.
6	V_{SS}	Chip negative supply, generally will be ground.
7	AHI	A High-side Input. Logic level input that controls AHO driver (Pin 10). ALI (Pin 4) high level input overrides AHI high level input to prevent half-bridge shoot-through, see Truth Table. DIS (Pin 8) high level input overrides AHI high level input. The pin can be driven by signal levels of 0V to 15V (no greater than V_{DD}).
8	DIS	DISable input. Logic level input that when taken high sets all four outputs low. DIS high overrides all other inputs. When DIS is taken low the outputs are controlled by the other inputs. The pin can be driven by signal levels of 0V to 15V (no greater than V_{DD}).
9	AHB	A High-side Bootstrap supply. External bootstrap diode and capacitor are required. Connect cathode of bootstrap diode and positive side of bootstrap capacitor to this pin.
10	AHO	A High-side Output. Connect to gate of A High-side power MOSFET.
11	AHS	A High-side Source connection. Connect to source of A High-side power MOSFET. Connect negative side of bootstrap capacitor to this pin.
12	V_{DD}	Positive supply to control logic and lower gate drivers. De-couple this pin to V_{SS} (Pin 6).
13	ALO	A Low-side Output. Connect to gate of A Low-side power MOSFET.
14	BLO	B Low-side Output. Connect to gate of B Low-side power MOSFET.
15	BHS	B High-side Source connection. Connect to source of B High-side power MOSFET. Connect negative side of bootstrap capacitor to this pin.
16	BHO	B High-side Output. Connect to gate of B High-side power MOSFET.

Timing Diagrams

X = A OR B, A AND B HALVES OF BRIDGE CONTROLLER ARE INDEPENDENT

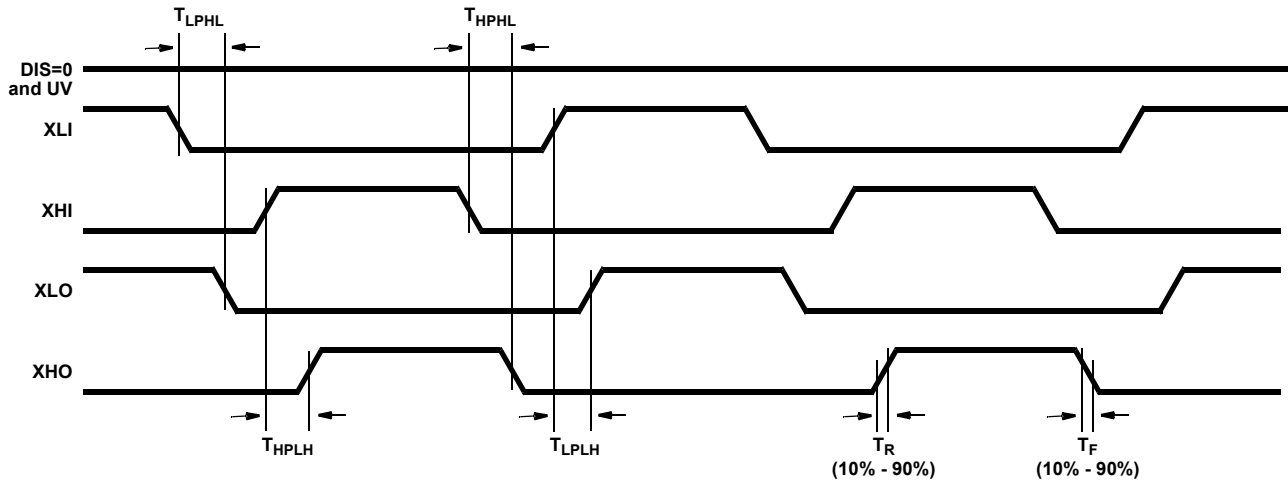

FIGURE 1. INDEPENDENT MODE

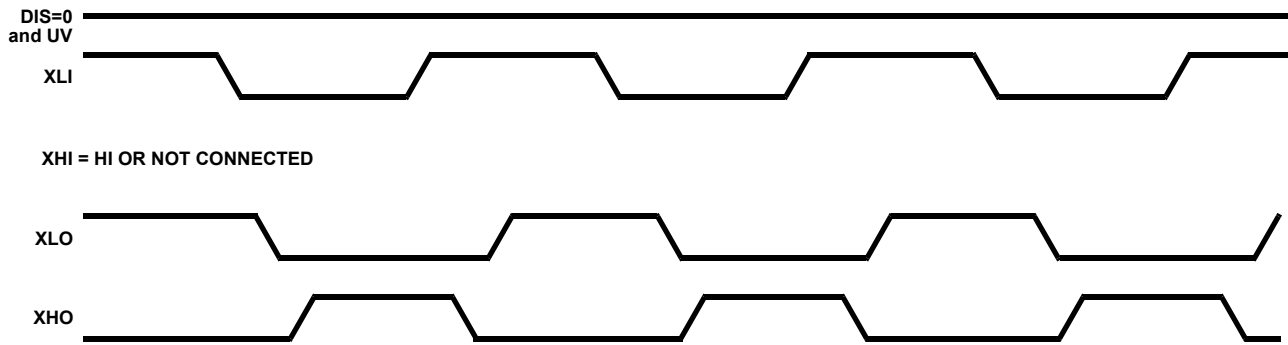

FIGURE 2. BISTATE MODE

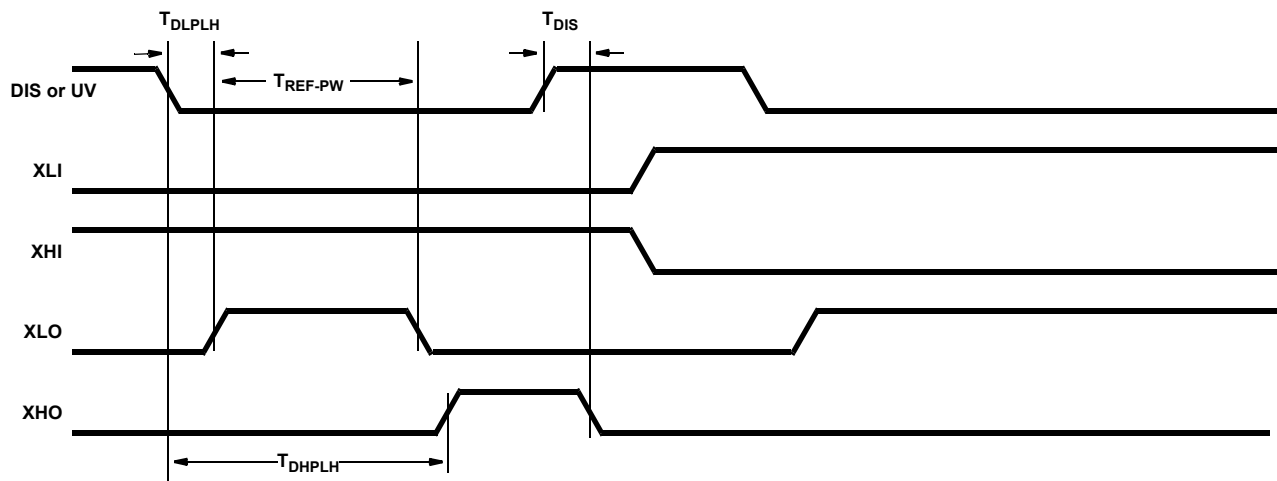

FIGURE 3. DISABLE FUNCTION

Performance Curves

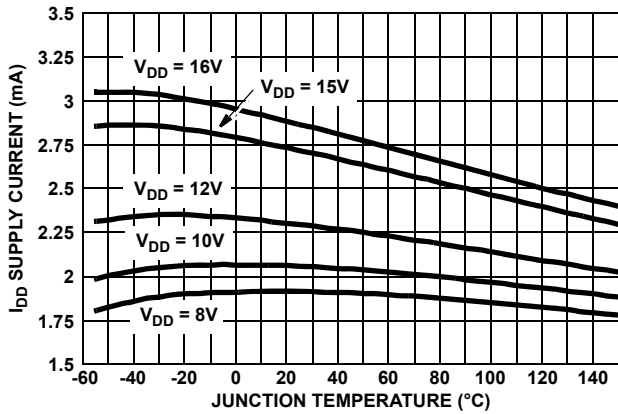

FIGURE 4. I_{DD} SUPPLY CURRENT vs TEMPERATURE AND V_{DD} SUPPLY VOLTAGE

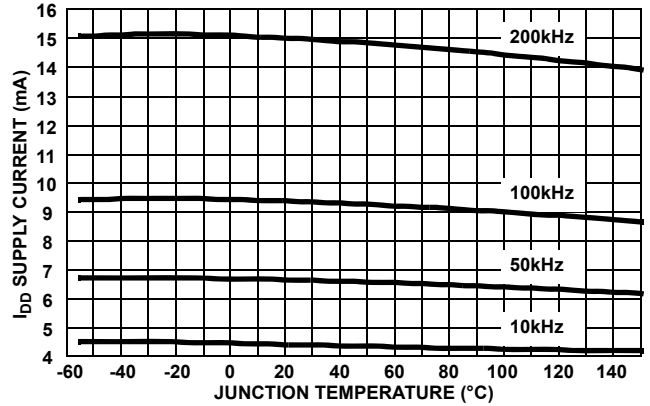

FIGURE 5. V_{DD} SUPPLY CURRENT vs TEMPERATURE AND SWITCHING FREQUENCY (1000pF LOAD)

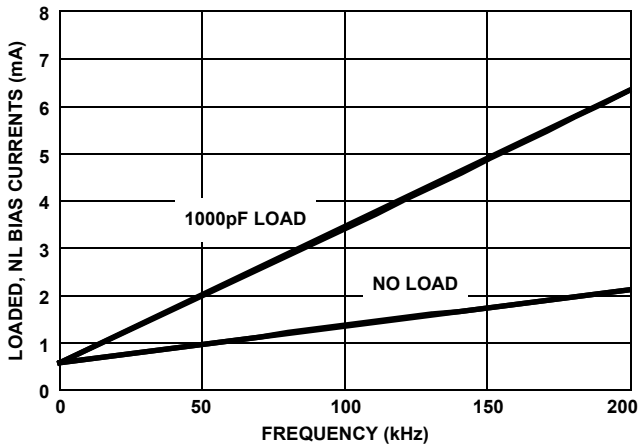

FIGURE 6. FLOATING (IXHB) BIAS CURRENT vs FREQUENCY AND LOAD

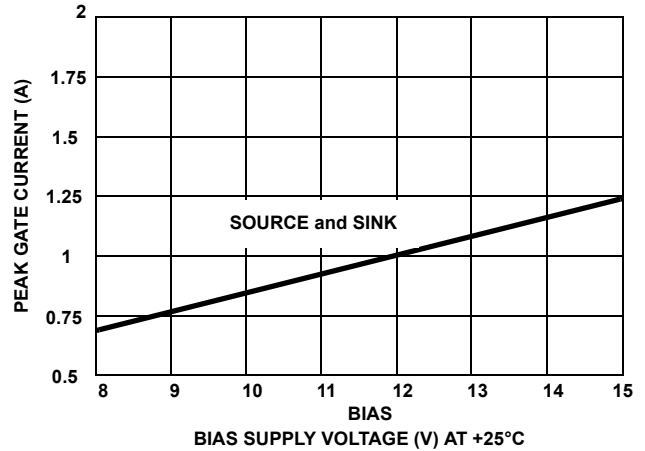

FIGURE 7. GATE SOURCE/SINK PEAK CURRENT vs BIAS SUPPLY VOLTAGE AT +25°C

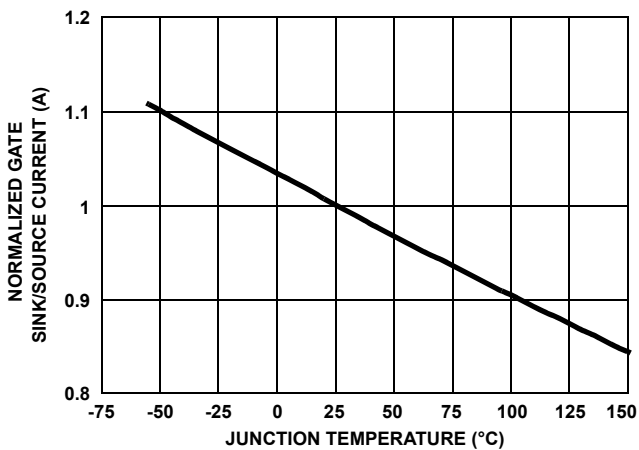

FIGURE 8. GATE CURRENT vs TEMPERATURE, NORMALIZED TO +25°C

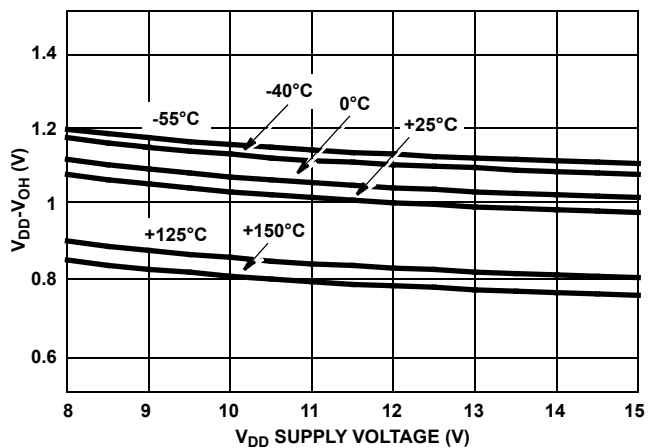

FIGURE 9. $V_{DD}-V_{OH}$ vs BIAS VOLTAGE TEMPERATURE

Performance Curves (Continued)

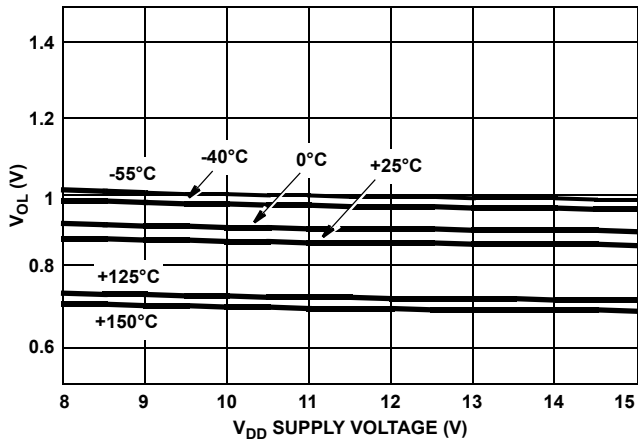

FIGURE 10. V_{OL} vs BIAS VOLTAGE AND TEMPERATURE

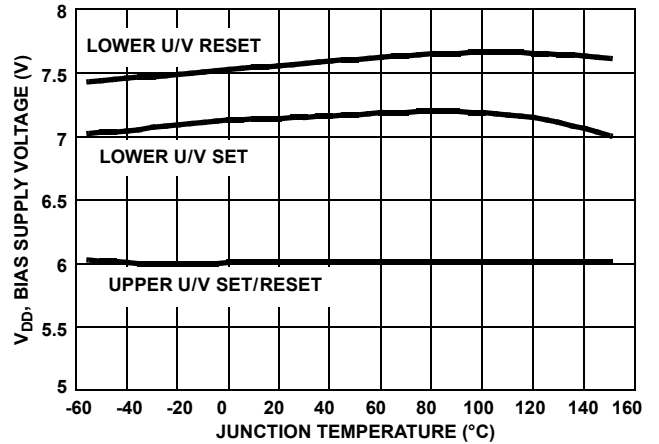

FIGURE 11. UNDERVOLTAGE TRIP VOLTAGES vs TEMPERATURE

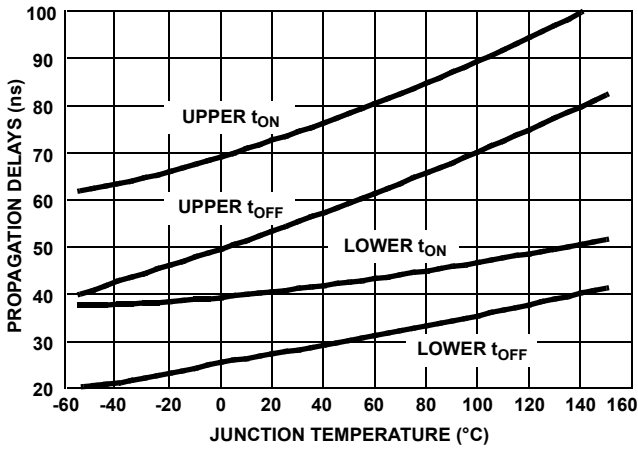

FIGURE 12. UPPER LOWER TURN-ON/TURN-OFF PROPAGATION DELAY vs TEMPERATURE

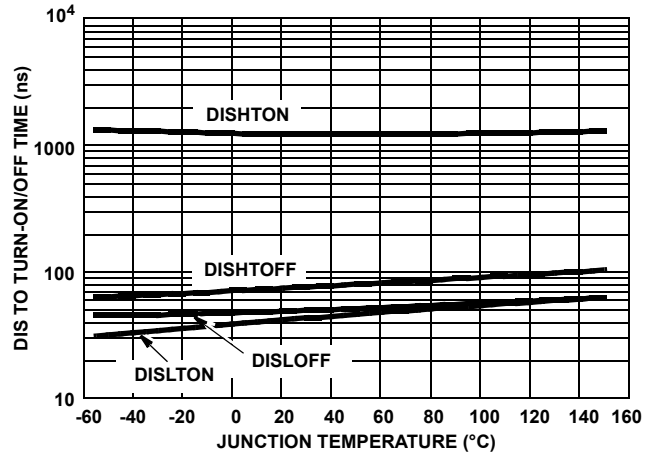

FIGURE 13. UPPER/LOWER DIS(ABLE) TO TURN-ON/OFF vs TEMPERATURE (°C)

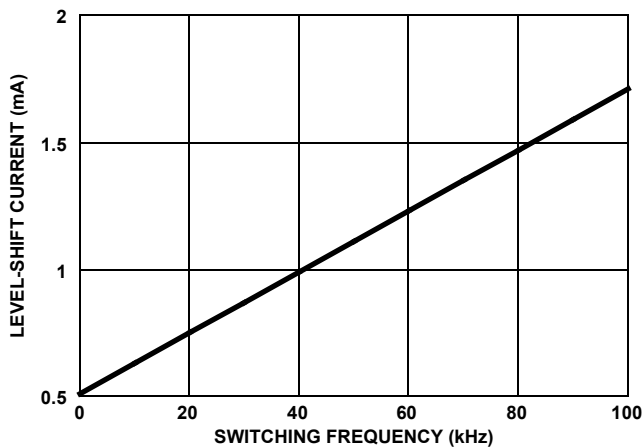

FIGURE 14. FULL BRIDGE LEVEL-SHIFT CURRENT vs FREQUENCY (kHz)

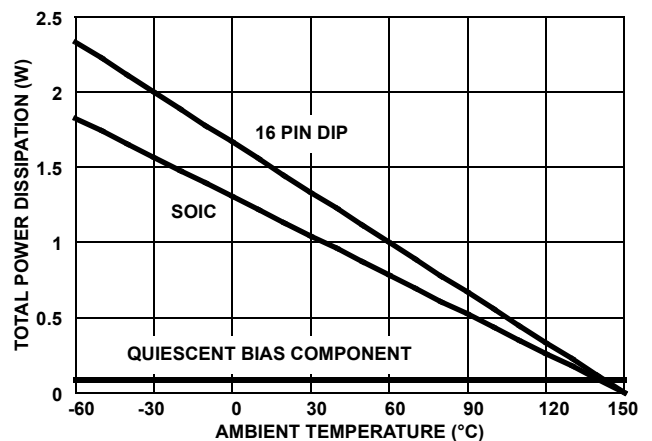

FIGURE 15. MAXIMUM POWER DISSIPATION vs AMBIENT TEMPERATURE

Performance Curves (Continued)

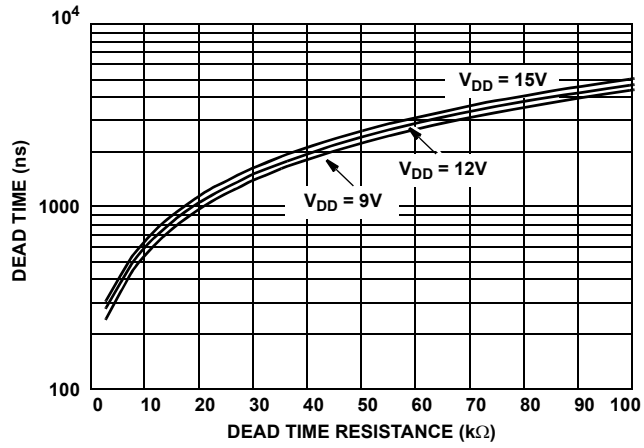
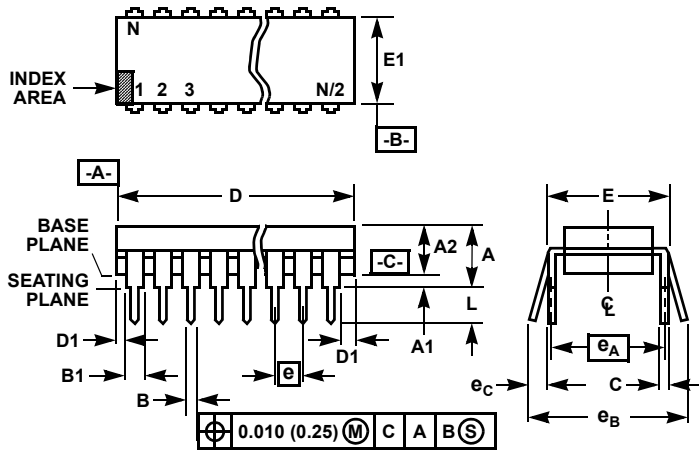

FIGURE 16. DEAD-TIME vs DEL RESISTANCE AND BIAS SUPPLY (V_{DD}) VOLTAGE

Dual-In-Line Plastic Packages (PDIP)



NOTES:

1. Controlling Dimensions: INCH. In case of conflict between English and Metric dimensions, the inch dimensions control.
2. Dimensioning and tolerancing per ANSI Y14.5M-1982.
3. Symbols are defined in the "MO Series Symbol List" in Section 2.2 of Publication No. 95.
4. Dimensions A, A1 and L are measured with the package seated in JEDEC seating plane gauge GS-3.
5. D, D1, and E1 dimensions do not include mold flash or protrusions. Mold flash or protrusions shall not exceed 0.010 inch (0.25mm).
6. E and e_A are measured with the leads constrained to be perpendicular to datum -C-.
7. e_B and e_C are measured at the lead tips with the leads unconstrained. e_C must be zero or greater.
8. B1 maximum dimensions do not include dambar protrusions. Dambar protrusions shall not exceed 0.010 inch (0.25mm).
9. N is the maximum number of terminal positions.
10. Corner leads (1, N, N/2 and N/2 + 1) for E8.3, E16.3, E18.3, E28.3, E42.6 will have a B1 dimension of 0.030 - 0.045 inch (0.76 - 1.14mm).

**E16.3 (JEDEC MS-001-BB ISSUE D)
16 LEAD DUAL-IN-LINE PLASTIC PACKAGE**

SYMBOL	INCHES		MILLIMETERS		NOTES
	MIN	MAX	MIN	MAX	
A	-	0.210	-	5.33	4
A1	0.015	-	0.39	-	4
A2	0.115	0.195	2.93	4.95	-
B	0.014	0.022	0.356	0.558	-
B1	0.045	0.070	1.15	1.77	8, 10
C	0.008	0.014	0.204	0.355	-
D	0.735	0.775	18.66	19.68	5
D1	0.005	-	0.13	-	5
E	0.300	0.325	7.62	8.25	6
E1	0.240	0.280	6.10	7.11	5
e	0.100 BSC		2.54 BSC		-
e_A	0.300 BSC		7.62 BSC		6
e_B	-	0.430	-	10.92	7
L	0.115	0.150	2.93	3.81	4
N	16		16		9

Rev. 0 12/93

Small Outline Plastic Packages (SOIC)

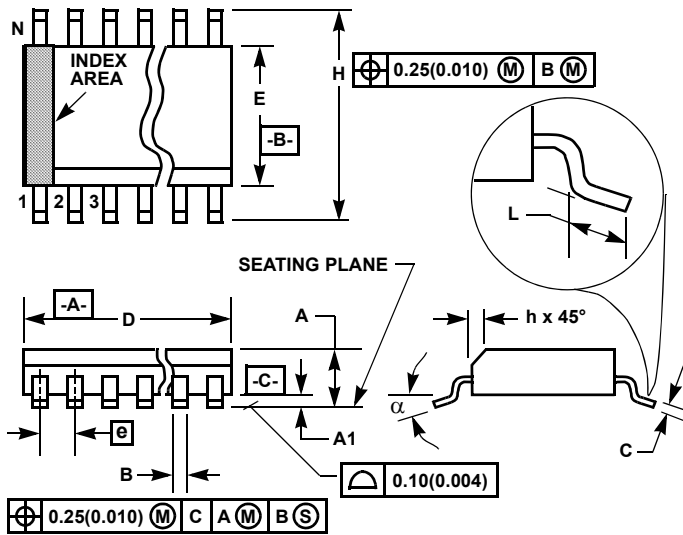

**M16.15 (JEDEC MS-012-AC ISSUE C)
16 LEAD NARROW BODY SMALL OUTLINE PLASTIC PACKAGE**

SYMBOL	INCHES		MILLIMETERS		NOTES
	MIN	MAX	MIN	MAX	
A	0.0532	0.0688	1.35	1.75	-
A1	0.0040	0.0098	0.10	0.25	-
B	0.013	0.020	0.33	0.51	9
C	0.0075	0.0098	0.19	0.25	-
D	0.3859	0.3937	9.80	10.00	3
E	0.1497	0.1574	3.80	4.00	4
e	0.050 BSC		1.27 BSC		-
H	0.2284	0.2440	5.80	6.20	-
h	0.0099	0.0196	0.25	0.50	5
L	0.016	0.050	0.40	1.27	6
N	16		16		7
α	0°	8°	0°	8°	-

NOTES:

1. Symbols are defined in the "MO Series Symbol List" in Section 2.2 of Publication Number 95.
2. Dimensioning and tolerancing per ANSI Y14.5M-1982.
3. Dimension "D" does not include mold flash, protrusions or gate burrs. Mold flash, protrusion and gate burrs shall not exceed 0.15mm (0.006 inch) per side.
4. Dimension "E" does not include interlead flash or protrusions. Interlead flash and protrusions shall not exceed 0.25mm (0.010 inch) per side.
5. The chamfer on the body is optional. If it is not present, a visual index feature must be located within the crosshatched area.
6. "L" is the length of terminal for soldering to a substrate.
7. "N" is the number of terminal positions.
8. Terminal numbers are shown for reference only.
9. The lead width "B", as measured 0.36mm (0.014 inch) or greater above the seating plane, shall not exceed a maximum value of 0.61mm (0.024 inch).
10. Controlling dimension: MILLIMETER. Converted inch dimensions are not necessarily exact.

Rev. 1 6/05

© Copyright Intersil Americas LLC 2006. All Rights Reserved.

All trademarks and registered trademarks are the property of their respective owners.

For additional products, see www.intersil.com/en/products.html

Intersil products are manufactured, assembled and tested utilizing ISO9001 quality systems as noted in the quality certifications found at www.intersil.com/en/support/qualandreliability.html

Intersil products are sold by description only. Intersil may modify the circuit design and/or specifications of products at any time without notice, provided that such modification does not, in Intersil's sole judgment, affect the form, fit or function of the product. Accordingly, the reader is cautioned to verify that datasheets are current before placing orders. Information furnished by Intersil is believed to be accurate and reliable. However, no responsibility is assumed by Intersil or its subsidiaries for its use; nor for any infringements of patents or other rights of third parties which may result from its use. No license is granted by implication or otherwise under any patent or patent rights of Intersil or its subsidiaries.

For information regarding Intersil Corporation and its products, see www.intersil.com

X-ON Electronics

Largest Supplier of Electrical and Electronic Components

Click to view similar products for [Gate Drivers](#) category:

Click to view products by [Renesas](#) manufacturer:

Other Similar products are found below :

[56956](#) [57.404.7355.5](#) [LT4936](#) [57.904.0755.0](#) [5811-0902](#) [0131700000](#) [LTP70N06](#) [LVP640](#) [5J0-1000LG-SIL](#) [LY2-US-AC240](#) [LY3-UA-DC24](#) [LZNQ2-US-DC12](#) [LZP40N10](#) [60100564](#) [60249-1-CUT-TAPE](#) [0134220000](#) [60713816](#) [61161-90](#) [6131-204-23149P](#) [6131-205-17149P](#) [6131-209-15149P](#) [6131-218-17149P](#) [6131-220-21149P](#) [6131-260-2358P](#) [6131-265-11149P](#) [CS1HCPU63](#) [6150-5001](#) [CSB4](#) [CSK-38-60006](#) [CSK-38-60008](#) [621A](#) [622-4053LF](#) [6273](#) [M40N08MA-H](#) [M55155/29XH06](#) [64-807](#) [65-1930-6](#) [CV500ISB02](#) [M83723/88Y1407N](#) [CWD012-2](#) [CWD03-3](#) [CX3225SB16934D0PPSC2](#) [CX5032GB10000D0PPS02](#) [687-772NF1](#) [70.140.1653](#) [70.200.0653.0](#) [703001B01F060](#) [70-3601](#) [706006D02F0601](#) [706210](#)