

## ISL88011, ISL88012, ISL88013, ISL88014, ISL88015

5 Ld Voltage Supervisors with Adjustable Power-On Reset, Dual Voltage Monitoring or Watchdog Timer Capability

FN8093  
Rev 5.00  
December 4, 2015

The ISL88011, ISL88012, ISL88013, ISL88014, ISL88015 family of devices offer both fixed and/or adjustable voltage-monitoring that combine popular functions such as Power-On reset control, watchdog timer, supply voltage supervision, and manual reset assertion in a small 5 Ld SOT-23 package.

Unique features on the ISL88013 and ISL88015 include a watchdog timer with a 51s start-up timeout and a 1.6s normal timeout duration. On the ISL88011 and ISL88014, users can increase the nominal 200ms Power-On reset timeout delay by adding an external capacitor to the  $C_{POR}$  pin. Both fixed and adjustable voltage monitors are provided by the ISL88012. Complementary active-low and active-high reset outputs are available on the ISL88011, ISL88012 and ISL88013 devices. All devices provide manual reset capability (see "Product Features Table" on page 5).

Seven preprogrammed reset threshold voltages accurate to  $\pm 1.5\%$  over temperature are offered (see "Ordering Information" on page 3). The ISL88012, ISL88014 and ISL88015 have a user-adjustable voltage input available for custom monitoring of any voltage down to 0.6V. All parts are specifically designed for low power consumption and high threshold accuracy.

### Features

- Single/dual voltage monitoring supervisors
- Fixed-voltage options allow precise monitoring of +2.5V, +3.0V, +3.3V, and +5.0V power supplies
- Dual supervisor has one fixed voltage input and another that is user-adjustable down to 0.6V.
- Both RST and  $\overline{RST}$  outputs available
- Adjustable POR timeout delay options
- Watchdog timer with 1.6s normal and 51s start-up timeout durations
- Manual reset input on all devices
- Reset signal valid down to  $V_{DD} = 1V$
- Accurate  $\pm 1.5\%$  voltage threshold
- Immune to power-supply transients
- Ultra low 5.5 $\mu A$  supply current
- Small 5 Ld SOT-23 Pb-Free package
- Pb-Free (RoHS Compliant)

### Applications

- Process control systems
- Intelligent instruments
- Embedded control systems
- Computer systems
- Critical  $\mu P$  and  $\mu C$  power monitoring
- Portable/battery-powered equipment
- PDA and handheld PC devices

**Pinouts**

**ISL88011**  
(5 LD SOT-23)  
TOP VIEW

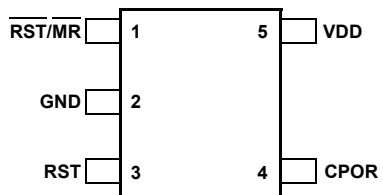

**ISL88012**  
(5 LD SOT-23)  
TOP VIEW

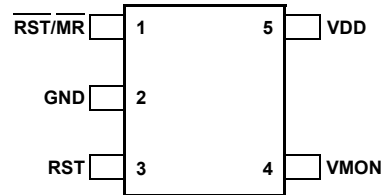

**ISL88013**  
(5 LD SOT-23)  
TOP VIEW

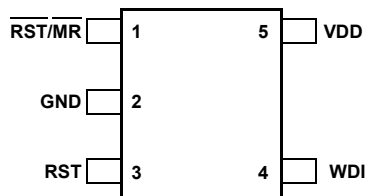

**ISL88014**  
(5 LD SOT-23)  
TOP VIEW

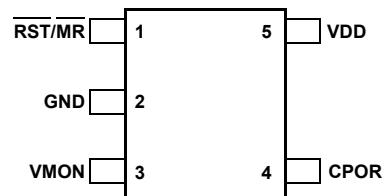

**ISL88015**  
(5 LD SOT-23)  
TOP VIEW

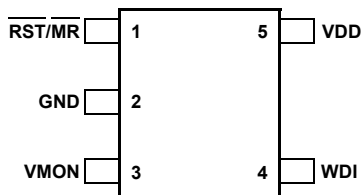

**Ordering Information**

PART NUMBER (Notes 1, 2, 3)	PART MARKING (Note 4)	V <sub>THVDD</sub> (V)	V <sub>THVMON</sub> (V)	TEMPERATURE RANGE (°C)	PACKAGE TAPE AND REEL (Pb-free)	PKG. DWG. #
ISL88011IH546Z-TK	AGU	4.64	N/A	-40 to +85	5 Ld SOT-23	P5.064
ISL88011IH546Z-T7A	AGU	4.64	N/A	-40 to +85	5 Ld SOT-23	P5.064
ISL88011IH544Z-TK	AGV	4.38	N/A	-40 to +85	5 Ld SOT-23	P5.064
ISL88011IH544Z-T7A	AGV	4.38	N/A	-40 to +85	5 Ld SOT-23	P5.064
ISL88011IH531Z-TK	AGW	3.09	N/A	-40 to +85	5 Ld SOT-23	P5.064
ISL88011IH531Z-T7A	AGW	3.09	N/A	-40 to +85	5 Ld SOT-23	P5.064
ISL88011IH529Z-TK	AGX	2.92	N/A	-40 to +85	5 Ld SOT-23	P5.064
ISL88011IH529Z-T7A	AGX	2.92	N/A	-40 to +85	5 Ld SOT-23	P5.064
ISL88011IH526Z-TK	AGY	2.63	N/A	-40 to +85	5 Ld SOT-23	P5.064
ISL88011IH526Z-T7A	AGY	2.63	N/A	-40 to +85	5 Ld SOT-23	P5.064
ISL88011IH523Z-TK	AGZ	2.32	N/A	-40 to +85	5 Ld SOT-23	P5.064
ISL88011IH523Z-T7A	AGZ	2.32	N/A	-40 to +85	5 Ld SOT-23	P5.064
ISL88011IH522Z-TK (No longer available, recommended replacement: ISL88013IH522Z-TK)	AHE	2.19	N/A	-40 to +85	5 Ld SOT-23	P5.064
ISL88011IH522Z-T7A (No longer available, recommended replacement: ISL88013IH522Z-T7A)	AHE	2.19	N/A	-40 to +85	5 Ld SOT-23	P5.064
ISL88012IH546Z-TK (No longer available or supported)	AHF	4.64	0.6 (Note 2)	-40 to +85	5 Ld SOT-23	P5.064
ISL88012IH546Z-T7A (No longer available or supported)	AHF	4.64	0.6 (Note 2)	-40 to +85	5 Ld SOT-23	P5.064
ISL88012IH544Z-TK (No longer available or supported)	AHG	4.38	0.6 (Note 2)	-40 to +85	5 Ld SOT-23	P5.064
ISL88012IH544Z-T7A (No longer available or supported)	AHG	4.38	0.6 (Note 2)	-40 to +85	5 Ld SOT-23	P5.064
ISL88012IH531Z-TK (No longer available or supported)	AHH	3.09	0.6 (Note 2)	-40 to +85	5 Ld SOT-23	P5.064
ISL88012IH531Z-T7A (No longer available or supported)	AHH	3.09	0.6 (Note 2)	-40 to +85	5 Ld SOT-23	P5.064
ISL88012IH529Z-TK (No longer available or supported)	AHI	2.92	0.6 (Note 2)	-40 to +85	5 Ld SOT-23	P5.064
ISL88012IH529Z-T7A (No longer available or supported)	AHI	2.92	0.6 (Note 2)	-40 to +85	5 Ld SOT-23	P5.064
ISL88012IH526Z-TK (No longer available or supported)	AHJ	2.63	0.6 (Note 2)	-40 to +85	5 Ld SOT-23	P5.064
ISL88012IH526Z-T7A (No longer available or supported)	AHJ	2.63	0.6 (Note 2)	-40 to +85	5 Ld SOT-23	P5.064
ISL88012IH523Z-TK (No longer available or supported)	AHK	2.32	0.6 (Note 2)	-40 to +85	5 Ld SOT-23	P5.064
ISL88012IH523Z-T7A (No longer available or supported)	AHK	2.32	0.6 (Note 2)	-40 to +85	5 Ld SOT-23	P5.064
ISL88012IH522Z-TK (No longer available or supported)	AHL	2.19	0.6 (Note 2)	-40 to +85	5 Ld SOT-23	P5.064
ISL88012IH522Z-T7A (No longer available or supported)	AHL	2.19	0.6 (Note 2)	-40 to +85	5 Ld SOT-23	P5.064
ISL88013IH546Z-TK (No longer available, recommended replacement: ISL88011IH546Z-TK)	AHM	4.64	N/A	-40 to +85	5 Ld SOT-23	P5.064
ISL88013IH546Z-T7A (No longer available, recommended replacement: ISL88011IH546Z-T7A)	AHM	4.64	N/A	-40 to +85	5 Ld SOT-23	P5.064
ISL88013IH544Z-TK	AHN	4.38	N/A	-40 to +85	5 Ld SOT-23	P5.064
ISL88013IH544Z-T7A	AHN	4.38	N/A	-40 to +85	5 Ld SOT-23	P5.064
ISL88013IH531Z-TK	AHO	3.09	N/A	-40 to +85	5 Ld SOT-23	P5.064
ISL88013IH531Z-T7A	AHO	3.09	N/A	-40 to +85	5 Ld SOT-23	P5.064
ISL88013IH529Z-TK	AHP	2.92	N/A	-40 to +85	5 Ld SOT-23	P5.064
ISL88013IH529Z-T7A	AHP	2.92	N/A	-40 to +85	5 Ld SOT-23	P5.064

**Ordering Information** (Continued)

PART NUMBER (Notes 1, 2, 3)	PART MARKING (Note 4)	V <sub>THVDD</sub> (V)	V <sub>THVMON</sub> (V)	TEMPERATURE RANGE (°C)	PACKAGE TAPE AND REEL (Pb-free)	PKG. DWG. #
ISL88013IH526Z-TK	AHQ	2.63	N/A	-40 to +85	5 Ld SOT-23	P5.064
ISL88013IH526Z-T7A	AHQ	2.63	N/A	-40 to +85	5 Ld SOT-23	P5.064
ISL88013IH523Z-TK (No longer available, recommended replacement: ISL88011IH523Z-TK)	AHR	2.32	N/A	-40 to +85	5 Ld SOT-23	P5.064
ISL88013IH523Z-T7A (No longer available, recommended replacement: ISL88011IH523Z-T7A)	AHR	2.32	N/A	-40 to +85	5 Ld SOT-23	P5.064
ISL88013IH522Z-TK	AHS	2.19	N/A	-40 to +85	5 Ld SOT-23	P5.064
ISL88013IH522Z-T7A	AHS	2.19	N/A	-40 to +85	5 Ld SOT-23	P5.064
ISL88014IH5Z-TK	AHT	N/A	0.6 (Note 2)	-40 to +85	5 Ld SOT-23	P5.064
ISL88014IH5Z-T7A	AHT	N/A	0.6 (Note 2)	-40 to +85	5 Ld SOT-23	P5.064
ISL88015IH5Z-TK (No longer available or supported)	AHU	N/A	0.6 (Note 2)	-40 to +85	5 Ld SOT-23	P5.064
ISL88015IH5Z-T7A (No longer available or supported)	AHU	N/A	0.6 (Note 2)	-40 to +85	5 Ld SOT-23	P5.064
ISL88011EVAL1Z	ISL88011 Evaluation Card					
ISL88013EVAL1Z	ISL88013 Evaluation Card					
ISL88014EVAL1Z	ISL88014 Evaluation Card					

NOTES:

- These Intersil Pb-free plastic packaged products employ special Pb-free material sets, molding compounds/die attach materials, and 100% matte tin plate plus anneal (e3 termination finish, which is RoHS compliant and compatible with both SnPb and Pb-free soldering operations). Intersil Pb-free products are MSL classified at Pb-free peak reflow temperatures that meet or exceed the Pb-free requirements of IPC/JEDEC J STD-020.
- The voltage trip point can be adjusted to be greater than 0.6V using 2 external resistors. By default, the V<sub>THVMON</sub> trip point is 0.6V if no external resistors are used.
- For Moisture Sensitivity Level (MSL), please see device information page for [ISL88011](#), [ISL88012](#), [ISL88013](#), [ISL88014](#), [ISL88015](#). For more information on MSL please see techbrief [TB363](#).
- The part marking is located on the bottom of the part.

**Functional Block Diagrams**



**Product Features Table**

FUNCTION	ISL88011	ISL88012	ISL88013	ISL88014	ISL88015
Active-Low Reset ( $\overline{\text{RST}}$ )	x	x	x	x	x
Active-High Reset (RST)	x	x	x		
Watchdog Timer (WDI)			x		x
Dual Voltage Supervision		x			
Adjustable POR Timeout ( $C_{\text{POR}}$ )	x			x	
Manual Reset Input ( $\overline{\text{MR}}$ )	x	x	x	x	x
Fixed Trip Point Voltage	x	x	x		
Adjustable Trip Point Voltage		x		x	x

**Pin Descriptions**

PIN					NAME	FUNCTION
ISL88011	ISL88012	ISL88013	ISL88014	ISL88015		
1	1	1	1	1	$\overline{\text{RST}}/\overline{\text{MR}}$	Combined Active-Low Reset Output and Manual Reset Input
2	2	2	2	2	GND	Ground
	4		3	3	VMON	Adjustable Threshold Voltage Input
3	3	3			RST	Active-High Reset Output
4			4		$C_{\text{POR}}$	Adjustable POR Timeout Delay Input
		4		4	WDI	Watchdog Timer Input
5	5	5	5	5	$V_{\text{DD}}$	Supply Voltage and Monitored Input

**Absolute Maximum Ratings**

Temperature Under Bias .....-40°C to +125°C  
 Storage Temperature .....-65°C to +150°C  
 Voltage on any pin with respect to GND .....-1.0V to +7V  
 DC Output Current. .... 5mA  
 ESD Rating  
 Human Body Model (Tested per JESD22-A114) .....2500V  
 Charged Device Model (Tested per JESD22-C101E) .....1200V  
 Machine Model (Tested per JESD22-A115) .....250V

**Thermal Information**

Thermal Resistance (Typical)  $\theta_{JA}$  (°C/W)  
 5 Ld SOT-23 (Note 5). .... 190  
 Maximum Junction Temperature (Plastic Package) ..... +125°C  
 Maximum Storage Temperature Range.....-65°C to +150°C  
 Pb-Free Reflow Profile.....see link below  
<http://www.intersil.com/pbfree/Pb-FreeReflow.asp>

**Recommended Operating Conditions**

Temperature Range (Industrial) .....-40°C to +85°C  
 Pull-up Resistance (R<sub>PJ</sub>) ..... 5kΩ to 100kΩ

*CAUTION: Do not operate at or near the maximum ratings listed for extended periods of time. Exposure to such conditions may adversely impact product reliability and result in failures not covered by warranty.*

NOTE:

- 5.  $\theta_{JA}$  is measured with the component mounted on a high effective thermal conductivity test board in free air. See Tech Brief [TB379](#) for details.

**Electrical Specifications** Over the recommended operating conditions unless otherwise specified, R<sub>PJ</sub> = 10kΩ.

SYMBOL	PARAMETER	TEST CONDITIONS	MIN	TYP	MAX	UNITS
V <sub>DD</sub>	Supply Voltage Range		2.0		5.5	V
I <sub>DD</sub>	Supply Current for ISL88011, ISL88012, ISL88013	V <sub>DD</sub> = 5.0V		8	11.5	μA
		V <sub>DD</sub> = 3.3V		7	10	μA
		V <sub>DD</sub> = 2.5V		5.5	9	μA
	Supply Current for ISL88014, ISL88015	V <sub>DD</sub> = 3.3V		4.5	8	μA
I <sub>LI</sub>	Input Leakage Current (VMON)				100	nA
I <sub>LO</sub>	Output Leakage Current (VMON)				100	nA
<b>VOLTAGE THRESHOLDS</b>						
V <sub>THVDD</sub>	Fixed V <sub>DD</sub> Voltage Trip Point	ISL88011, ISL88012, ISL88013IH546	4.57	4.64	4.71	V
		ISL88011, ISL88012, ISL88013IH544	4.31	4.38	4.45	V
		ISL88011, ISL88012, ISL88013IH531	3.04	3.09	3.14	V
		ISL88011, ISL88012, ISL88013IH529	2.88	2.92	2.96	V
		ISL88011, ISL88012, ISL88013IH526	2.59	2.63	2.67	V
		ISL88011, ISL88012, ISL88013IH523	2.29	2.32	2.35	V
		ISL88011, ISL88012, ISL88013IH522	2.16	2.19	2.22	V
V <sub>THVDD</sub> HYST	Hysteresis at V <sub>DD</sub> Input	V <sub>THVDD</sub> = 4.64V		46		mV
		V <sub>THVDD</sub> = 4.38V		44		mV
		V <sub>THVDD</sub> = 3.09V		31		mV
		V <sub>THVDD</sub> = 2.92V		29		mV
		V <sub>THVDD</sub> = 2.63V		26		mV
		V <sub>THVDD</sub> = 2.32V		23		mV
		V <sub>THVDD</sub> = 2.19V		22		mV
V <sub>THVMON</sub>	Adj. Reset Voltage Trip Point (Note 6)	V <sub>THVDD</sub> = 4.64V	599	605	611	mV
		V <sub>THVDD</sub> = 4.38V	597	603	609	mV
		V <sub>THVDD</sub> = 3.09V	589	595	601	mV
		V <sub>THVDD</sub> = 2.92V	589	595	601	mV
		V <sub>THVDD</sub> = 2.63V	589	595	601	mV
		V <sub>THVDD</sub> = 2.32V	597	603	609	mV
		V <sub>THVDD</sub> = 2.19V	597	603	609	mV

**Electrical Specifications** Over the recommended operating conditions unless otherwise specified,  $R_{PU} = 10k\Omega$ . (Continued)

SYMBOL	PARAMETER	TEST CONDITIONS	MIN	TYP	MAX	UNITS
$V_{THVMON}$	Adj. Reset Voltage Trip Point (Note 7)		594	600	606	mV
$V_{THVMON}$ $HYST$	Hysteresis Voltage (Notes 6, 7)			3		mV
<b>RESET</b>						
$V_{OL}$	Reset Output Voltage Low	$V_{DD} \geq 3.3V$ , Sinking 0.5mA		0.05	0.40	V
		$V_{DD} < 3.3V$ , Sinking 0.5mA		0.05	0.40	V
$V_{OH}$	Reset Output Voltage High	$V_{DD} \geq 3.3V$ , Sourcing 0.4mA	$V_{DD}-0.6$	$V_{DD}-0.4$		V
		$V_{DD} < 3.3V$ , Sourcing 0.4mA	$V_{DD}-0.6$	$V_{DD}-0.4$		V
$t_{RPD}$	$V_{TH}$ to Reset Asserted Delay			60		$\mu s$
$t_{POR}$	POR Timeout Delay	ISL88012, ISL88013, ISL88015	140	200	260	ms
		ISL88011, ISL88014 with $C_{POR} = OPEN$	200	250		ms
$C_{LOAD}$	Load Capacitance on Reset Pins			5		pF
<b>MANUAL RESET</b>						
$V_{MR}$	$\overline{MR}$ Input Voltage		0		100	mV
$t_{MR}$	$\overline{MR}$ Minimum Pulse Width		1			$\mu s$
<b>WATCHDOG TIMER (Note 8)</b>						
Start $t_{WDT}$	Start-up Watchdog Timeout Period		32	51	64	sec
$t_{WDT}$	Normal Watchdog Timeout Period		1.0	1.6	2.0	sec
$t_{WDPS}$	WDI Minimum Pulse Width		100			ns
$V_{IL}$	Watchdog Input Voltage Low				$0.3 \times V_{DD}$	V
$V_{IH}$	Watchdog Input Voltage High		$0.85 \times V_{DD}$			V
$I_{WDT}$	Watchdog Input Current				100	nA

## NOTES:

6. Applies to ISL88012.
7. Applies to ISL88014 and ISL88015.
8. Applies to ISL88013 and ISL88015.

## Pin Description

### RST

The push-pull RST output is set to  $V_{DD}$  (HIGH) listed in the following:

1. The device is first powered up.
2. Either  $V_{DD}$  or the voltage on VMON falls below their respective minimum voltage sense levels.
3.  $\overline{MR}$  is asserted.
4. The watchdog timeout expires.

### $\overline{RST}/\overline{MR}$

This pin functions as both a reset output and a manual reset input. The  $\overline{RST}$  output functions identically to the complementary RST output but is an open drain output that is pulled to GND (LOW) when reset is asserted. The  $\overline{MR}$  input is an active-low debounced input to which a user can connect a push-button to add manual reset capability or drive with active low signal from a controller.

### $V_{DD}$

The  $V_{DD}$  pin is the power supply terminal. It is monitored by the ISL88011, ISL88012 and ISL88013. For these devices, the voltage at this pin is compared against an internal factory-programmed voltage trip point,  $V_{THVDD}$ . A reset is first asserted when the device is initially powered up to

ensure that the power supply has stabilized. Thereafter, reset is again asserted whenever  $V_{DD}$  falls below  $V_{THVDD}$ . The device is designed with hysteresis to help prevent chattering due to noise.

### VMON

The VMON pin on the ISL88012, ISL88014 and ISL88015 is a monitored input voltage that is user-adjustable. The voltage at this pin is compared against an internal 600mV reference voltage ( $V_{THVMON}$ ) and a reset is asserted whenever the monitored voltage falls below this trip point.

### WDI

The Watchdog Input takes an input from a microprocessor and ensures that it periodically toggles the WDI pin, otherwise the internal watchdog timer runs out and reset is asserted. The internal Watchdog Timer is cleared whenever the WDI input pin sees a rising or falling edge or the device is manually reset.

### CPOR

The CPOR input pin lets users increase the Power-On Reset timeout delay ( $t_{POR}$ ) by connecting a capacitor between CPOR and ground. (See Figure 3)

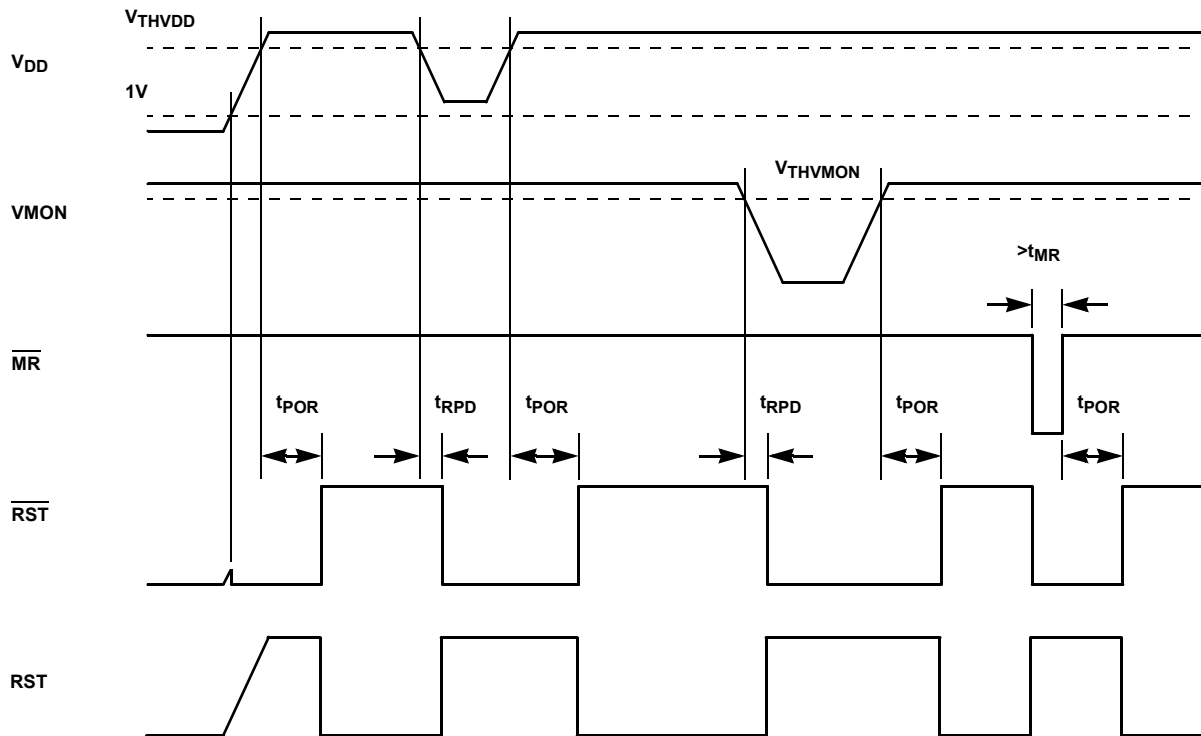

FIGURE 1. VOLTAGE MONITORING TIMING DIAGRAM



## Principles of Operation

The ISL88011, ISL88012, ISL88013, ISL88014, ISL88015 devices provide those functions needed for critical voltage monitoring. These features include Power-On Reset control, customizable supply voltage supervision, Watchdog Timer capability, and manual reset assertion. By integrating all of these features into a small 5 Ld SOT-23 package and using only 5.5µA of supply current, the ISL88011, ISL88012, ISL88013, ISL88014, ISL88015 devices can assist in lowering system cost, reducing board space requirements, and increasing the reliability of a system.

### Low Voltage Monitoring

During normal operation, these supervisors monitor both the voltage level of V<sub>DD</sub> (ISL88011, ISL88012, ISL88013) and/or V<sub>MON</sub> (ISL88012, ISL88014, ISL88015). The device asserts a reset if any of these voltages falls below their respective trip points. The reset signal effectively prevents the system from operating during a power failure or brownout condition. This reset signal remains asserted until V<sub>DD</sub> and the voltage on V<sub>MON</sub> exceed their voltage threshold setting for the reset time delay period t<sub>POR</sub> of 200ms (See Figure 1)

The ISL88012, ISL88014 and ISL88015 allow users to customize the minimum voltage sense level on the V<sub>MON</sub> input pin. To do this, connect an external resistor divider network to the V<sub>MON</sub> pin in order to set the trip point to some voltage above 600mV according to the following Equation 1 (See Figure 2).

$$V_{INTRIP} = 0.6 \times \frac{(R_1 + R_2)}{R_2} \quad (\text{EQ. 1})$$



FIGURE 2. USING V<sub>MON</sub> TO MONITOR V<sub>IN</sub> VIA RESISTORS

### Power-On Reset (POR)

Applying at least 1V to the V<sub>DD</sub> pin activates a POR circuit which asserts reset (i.e., RST goes HIGH while  $\overline{\text{RST}}$  goes LOW). The reset signals remain asserted until the voltage at V<sub>DD</sub> and/or V<sub>MON</sub> rise above the minimum voltage sense level for time period t<sub>POR</sub>. This ensures that the voltages have stabilized.

These reset signals provide several benefits:

- It prevents the system microprocessor from starting to operate with insufficient voltage.
- It prevents the processor from operating prior to stabilization of the oscillator.
- It ensures that the monitored device is held out of operation until internal registers are properly loaded.
- It allows time for an FPGA to download its configuration prior to initialization of the circuit.

### Adjusting POR Timeout via C<sub>POR</sub> Pin

On the ISL88011 and ISL88014, users can adjust the Power-On Reset timeout delay (t<sub>POR</sub>) up to many times the normal t<sub>POR</sub> of 250ms. To do this, connect a capacitor between C<sub>POR</sub> and ground (see Figure 3). For example, connecting a 30pF capacitor to C<sub>POR</sub> will increase t<sub>POR</sub> from a typical 250ms to about 2.5s. **NOTE:** Care should be taken in PCB layout and capacitor placement in order to reduce stray capacitance as much as possible, which lengthens the t<sub>POR</sub> timeout period.

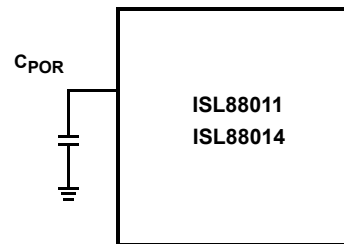

FIGURE 3. ADJUSTING t<sub>POR</sub> WITH A CAPACITOR

**Manual Reset**

The manual reset input ( $\overline{MR}$ ) allows the user to trigger a reset by using a push-button switch. The  $\overline{MR}$  input is an active-low debounced input. By connecting a push-button directly from  $\overline{MR}$  to ground, the designer adds manual system reset capability (see Figure 4). Reset is asserted if the  $\overline{MR}$  pin is pulled low to less than 100mV for 1 $\mu$ s or longer while the push-button is closed. After  $\overline{MR}$  is released, the reset outputs remain asserted for  $t_{POR}$  (200ms) and then released.

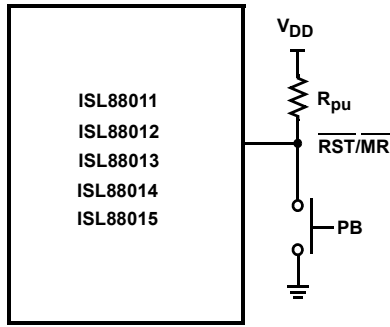

FIGURE 4. CONNECTING A MANUAL RESET PUSH-BUTTON

**Watchdog Timer**

The Watchdog Timer circuit checks microprocessor activity by monitoring the WDI input pin. The microprocessor must periodically toggle the WDI pin within  $t_{WDT}$  (1.6s nominal), otherwise the reset signal is asserted (see Figure 5). Internally, the 1.6s timer is cleared by either a reset or by toggling the WDI input.

Besides the 1.6s default timeout during normal operation, these devices also have a longer 51s timeout for start-up. During this time, a reset cannot be asserted due to the WDI not being toggled. The longer delay at power-on allows an operating system to boot, an FPGA to initialize, or the system software to initialize without the burden of dealing with the Watchdog.

**Symbol Table**

WAVEFORM	INPUTS	OUTPUTS
	Must be steady	Will be steady
	May change from LOW to HIGH	Will change from LOW to HIGH
	May change from HIGH to LOW	Will change from HIGH to LOW
	Don't Care: Changes Allowed	Changing: State Not Known
	N/A	Center Line is High Impedance

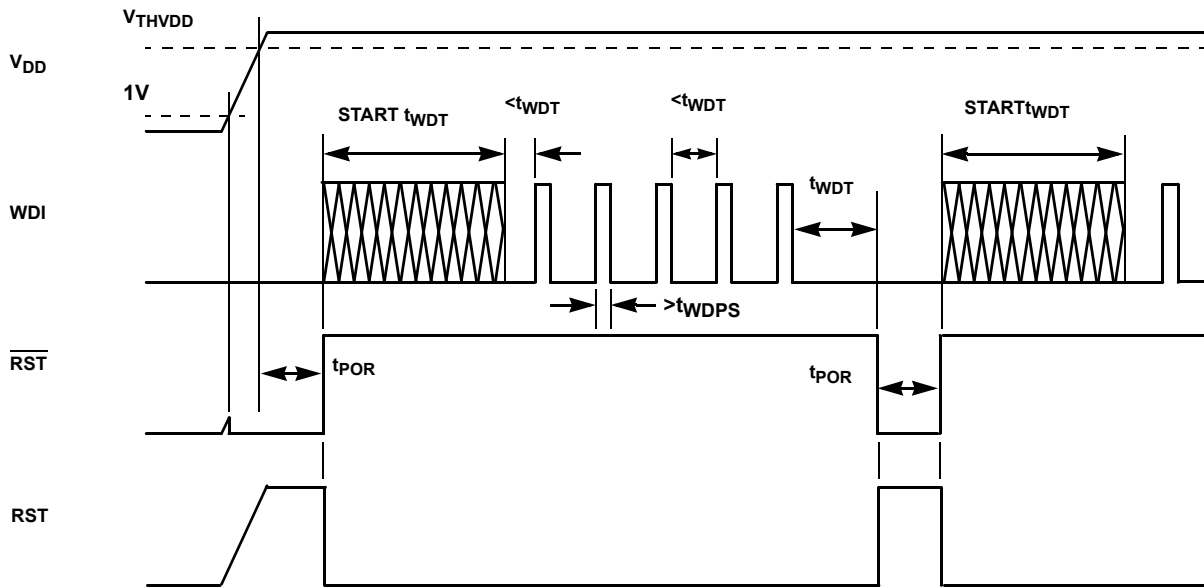

FIGURE 5. WATCHDOG TIMING DIAGRAM

## Typical Parametric Performance Curves

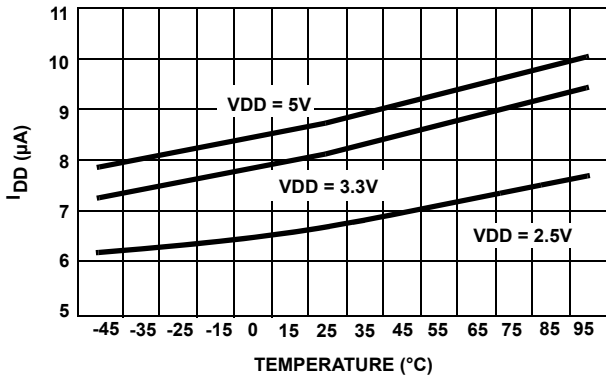

FIGURE 6. I<sub>DD</sub> (ISL88011, ISL88012, ISL88013) vs TEMPERATURE

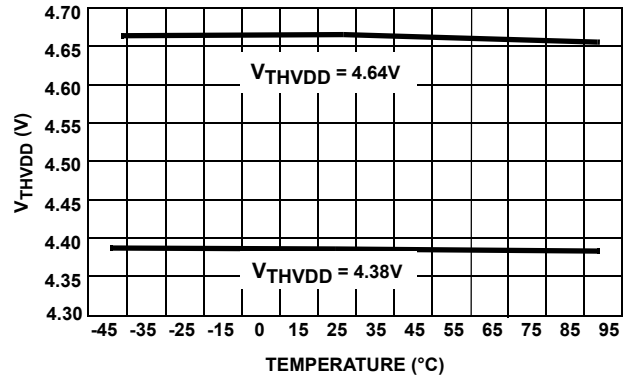

FIGURE 7. V<sub>THVDD</sub>, V<sub>DD</sub> = 5V vs TEMPERATURE

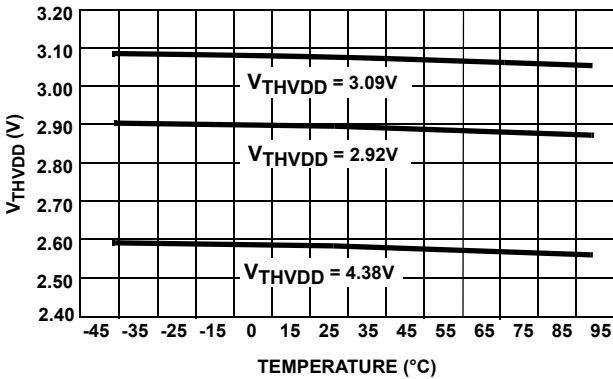

FIGURE 8. V<sub>THVDD</sub>, V<sub>DD</sub> = 3.3V vs TEMPERATURE

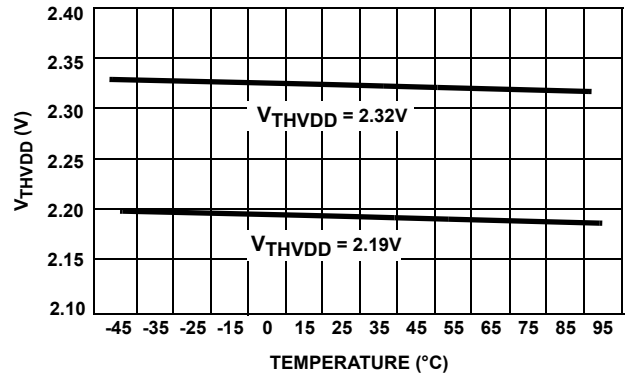

FIGURE 9. V<sub>THVDD</sub>, V<sub>DD</sub> = 2.5V vs TEMPERATURE



FIGURE 10. V<sub>THVMON</sub> vs TEMPERATURE



FIGURE 11. t<sub>POR</sub> (C<sub>POR</sub> OPEN) vs TEMPERATURE

## Typical Application Circuits



FIGURE 12. HIGH ACCURACY 12V SUPPLY MONITOR



FIGURE 13. 12V SUPPLY PGOOD or PGOOD

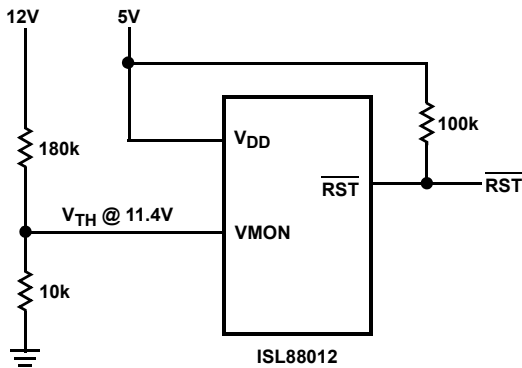

FIGURE 14. MONITOR 5V AND 12V SUPPLIES



PGOOD = HIGH IF  $-V < -4.6V$  AND  $-V + +V > 9.4$  (abs)

FIGURE 15. +5V AND -5V MONITOR



VOLTAGE OUT OF RANGE = PGOOD LOW

FIGURE 16. OVER/UNDERVOLTAGE MONITOR

## ISL8801XEVAL1Z Board Schematics

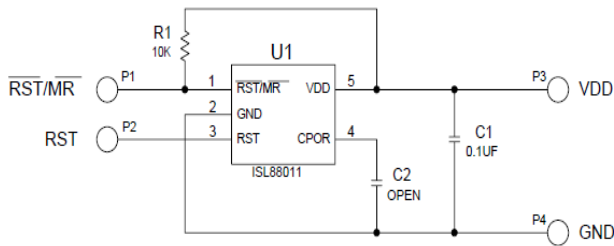

FIGURE 17. ISL88011EVAL1Z



FIGURE 18. ISL88012EVAL1Z

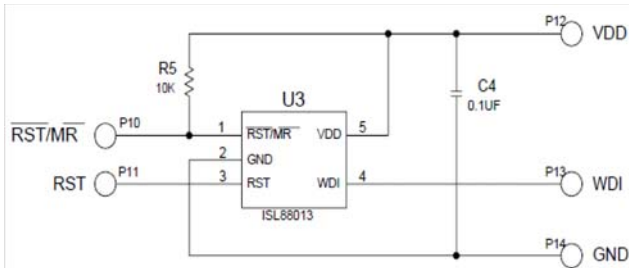

FIGURE 19. ISL88013EVAL1Z

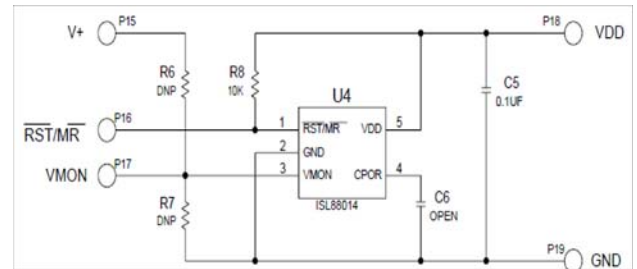

FIGURE 20. ISL88014EVAL1Z

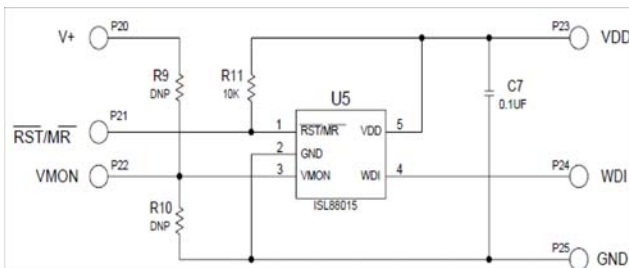

FIGURE 21. ISL88015EVAL1Z



Each of the ISL8801X parts has its own evaluation board provided with minimal customization, allowing the user to program with passive components both the POR timing and adjustable VMON thresholds, where applicable. The ISL88011EVAL1Z, ISL88012EVAL1Z and ISL88013EVAL1Z have a 4.6V Vth part installed.

FIGURE 22. THE TYPICAL ISL8801XEVAL1Z MEASURING 0.5" x 1"

## Revision History

The revision history provided is for informational purposes only and is believed to be accurate, but not warranted. Please go to the web to make sure that you have the latest revision.

DATE	REVISION	CHANGE
December 4, 2015	FN8093.5	Updated Ordering Information Table on page 3 and page 4. Added Revision History and About Intersil sections.

## About Intersil

Intersil Corporation is a leading provider of innovative power management and precision analog solutions. The company's products address some of the largest markets within the industrial and infrastructure, mobile computing and high-end consumer markets. For the most updated datasheet, application notes, related documentation and related parts, please see the respective product information page found at [www.intersil.com](http://www.intersil.com).

You may report errors or suggestions for improving this datasheet by visiting [www.intersil.com/ask](http://www.intersil.com/ask).

Reliability reports are also available from our website at [www.intersil.com/support](http://www.intersil.com/support)

© Copyright Intersil Americas LLC 2004-2015. All Rights Reserved.  
All trademarks and registered trademarks are the property of their respective owners.

For additional products, see [www.intersil.com/en/products.html](http://www.intersil.com/en/products.html)

Intersil products are manufactured, assembled and tested utilizing ISO9001 quality systems as noted in the quality certifications found at [www.intersil.com/en/support/qualandreliability.html](http://www.intersil.com/en/support/qualandreliability.html)

*Intersil products are sold by description only. Intersil may modify the circuit design and/or specifications of products at any time without notice, provided that such modification does not, in Intersil's sole judgment, affect the form, fit or function of the product. Accordingly, the reader is cautioned to verify that datasheets are current before placing orders. Information furnished by Intersil is believed to be accurate and reliable. However, no responsibility is assumed by Intersil or its subsidiaries for its use; nor for any infringements of patents or other rights of third parties which may result from its use. No license is granted by implication or otherwise under any patent or patent rights of Intersil or its subsidiaries.*

For information regarding Intersil Corporation and its products, see [www.intersil.com](http://www.intersil.com)

# Package Outline Drawing

## P5.064

### 5 LEAD SMALL OUTLINE TRANSISTOR PLASTIC PACKAGE

Rev 3, 4/11



**NOTES:**

1. Dimensioning and tolerance per ASME Y14.5M-1994.
2. Package conforms to EIAJ SC-74 and JEDEC MO178AA.
3. Package length and width are exclusive of mold flash, protrusions, or gate burrs.
4. Footlength measured at reference to gauge plane.
5. Lead thickness applies to the flat section of the lead between 0.08mm and 0.15mm from the lead tip.
6. Controlling dimension: MILLIMETER.  
Dimensions in ( ) for reference only.

## X-ON Electronics

Largest Supplier of Electrical and Electronic Components

*Click to view similar products for [Power Management IC Development Tools](#) category:*

*Click to view products by [Renesas](#) manufacturer:*

Other Similar products are found below :

[EVAL6482H-DISC](#) [EVAL-AD5522EBUZ](#) [EVAL-ADM1060EBZ](#) [EVAL-ADM1073MEBZ](#) [EVAL-ADM1166TQEBZ](#) [EVAL-ADM1168LQEBZ](#) [EVAL-ADM1171EBZ](#) [EVAL-ADM1276EBZ](#) [EVB-EN5319QI](#) [EVB-EN5365QI](#) [EVB-EN6347QI](#) [EVB-EP5348UI](#) [MIC23158YML EV](#) [MIC23451-AAAYFL EV](#) [MIC5281YMME EV](#) [124352-HMC860LP3E](#) [ADM00513](#) [ADM8611-EVALZ](#) [ADM8612-EVALZ](#) [ADM8613-EVALZ](#) [ADP1046ADC1-EVALZ](#) [ADP1055-EVALZ](#) [ADP122-3.3-EVALZ](#) [ADP130-0.8-EVALZ](#) [ADP130-1.2-EVALZ](#) [ADP130-1.5-EVALZ](#) [ADP130-1.8-EVALZ](#) [ADP160UJZ-REDYKIT](#) [ADP166UJ-EVALZ](#) [ADP1712-3.3-EVALZ](#) [ADP1714-3.3-EVALZ](#) [ADP1715-3.3-EVALZ](#) [ADP1716-2.5-EVALZ](#) [ADP1740-1.5-EVALZ](#) [ADP1752-1.5-EVALZ](#) [ADP1754-1.5-EVALZ](#) [ADP1828LC-EVALZ](#) [ADP1870-0.3-EVALZ](#) [ADP1871-0.6-EVALZ](#) [ADP1873-0.6-EVALZ](#) [ADP1874-0.3-EVALZ](#) [ADP1876-EVALZ](#) [ADP1879-1.0-EVALZ](#) [ADP1882-1.0-EVALZ](#) [ADP1883-0.6-EVALZ](#) [ADP197CB-EVALZ](#) [ADP199CB-EVALZ](#) [ADP2102-1.25-EVALZ](#) [ADP2102-1.2-EVALZ](#) [ADP2102-1.875EVALZ](#)