

ISL9000

Dual LDO with Low Noise, Very High PSRR and Low IQ

FN9217
Rev 4.00
March 11, 2008

ISL9000 is a high performance dual LDO capable of sourcing 300mA current from each output. It has a low standby current and very high PSRR and is stable with output capacitance of 1µF to 10µF with ESR of up to 200mΩ.

The device integrates an individual Power-On-Reset (POR) function for each output. The POR delay for VO2 can be externally programmed by connecting a timing capacitor to the CPOR pin. The POR delay for VO1 is internally fixed at approximately 2ms. A reference bypass pin is also provided for connecting a noise filtering capacitor for low noise and high-PSRR applications.

The quiescent current is typically only 42µA with both LDOs enabled and active. Separate enable pins control each individual LDO output. When both enable pins are low, the device is in shutdown, typically drawing less than 0.1µA.

Several combinations of voltage outputs are standard. Output voltage options for each LDO range are from 1.5V to 3.3V. Other output voltage options may be available upon request.

Pinout

ISL9000
(10 LD 3X3 DFN)
TOP VIEW

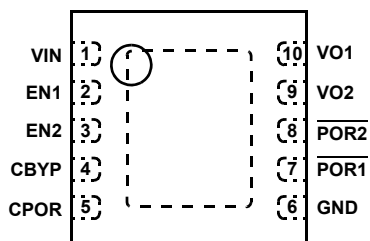

Features

- Integrates two 300mA high performance LDOs
- Excellent transient response to large current steps
- ±1.8% accuracy over all operating conditions
- Excellent load regulation:
< 0.1% voltage change across full range of load current
- Low output noise: typically 30µVRMS @ 100µA (1.5V)
- Very high PSRR: 90dB @ 1kHz
- Extremely low quiescent current: 42µA (both LDOs active)
- Wide input voltage capability: 2.3V to 6.5V
- Low dropout voltage: typically 200mV @ 300mA
- Stable with 1µF to 10µF ceramic capacitors
- Separate enable and POR pins for each LDO
- Soft-start and staged turn-on to limit input current surge during enable
- Current limit and overheat protection
- Tiny 10 Ld 3mmx3mm DFN package
- -40°C to +85°C operating temperature range
- Pb-free (RoHS compliant)

Applications

- PDAs, Cell Phones and Smart Phones
- Portable Instruments, MP3 Players
- Handheld Devices including Medical Handhelds

Ordering Information

PART NUMBER (Notes 1, 2, 3)	PART MARKING	VO1 VOLTAGE (V)	VO2 VOLTAGE (V)	TEMP RANGE (°C)	PACKAGE (Pb-Free)	PKG DWG. #
ISL9000IRNNZ	DCGA	3.3	3.3	-40 to +85	10 Ld 3x3 DFN	L10.3x3C
ISL9000IRNJZ	DAAA	3.3	2.8	-40 to +85	10 Ld 3x3 DFN	L10.3x3C
ISL9000IRNFZ	DBAA	3.3	2.5	-40 to +85	10 Ld 3x3 DFN	L10.3x3C
ISL9000IRNCZ	DABH	3.3	1.8	-40 to +85	10 Ld 3x3 DFN	L10.3x3C
ISL9000IRMNZ	DCHA	3.0	3.3	-40 to +85	10 Ld 3x3 DFN	L10.3x3C
ISL9000IRMMZ	DSAA	3.0	3.0	-40 to +85	10 Ld 3x3 DFN	L10.3x3C
ISL9000IRMGZ	DCJA	3.0	2.7	-40 to +85	10 Ld 3x3 DFN	L10.3x3C
ISL9000IRLLZ	DRAA	2.9	2.9	-40 to +85	10 Ld 3x3 DFN	L10.3x3C
ISL9000IRKNZ	DABF	2.85	3.3	-40 to +85	10 Ld 3x3 DFN	L10.3x3C
ISL9000IRKKZ	DCAA	2.85	2.85	-40 to +85	10 Ld 3x3 DFN	L10.3x3C
ISL9000IRKJZ	DDAA	2.85	2.8	-40 to +85	10 Ld 3x3 DFN	L10.3x3C
ISL9000IRKFZ	DEAA	2.85	2.5	-40 to +85	10 Ld 3x3 DFN	L10.3x3C
ISL9000IRKPZ	DABG	2.85	1.85	-40 to +85	10 Ld 3x3 DFN	L10.3x3C
ISL9000IRKCZ	DHAA	2.85	1.8	-40 to +85	10 Ld 3x3 DFN	L10.3x3C
ISL9000IRJNZ	DCKA	2.8	3.3	-40 to +85	10 Ld 3x3 DFN	L10.3x3C
ISL9000IRJMZ	DPAA	2.8	3.0	-40 to +85	10 Ld 3x3 DFN	L10.3x3C
ISL9000IRJRZ	DNAA	2.8	2.6	-40 to +85	10 Ld 3x3 DFN	L10.3x3C
ISL9000IRJCZ	DMAA	2.8	1.8	-40 to +85	10 Ld 3x3 DFN	L10.3x3C
ISL9000IRJBZ	DFAA	2.8	1.5	-40 to +85	10 Ld 3x3 DFN	L10.3x3C
ISL9000IRGPZ	DABE	2.7	1.85	-40 to +85	10 Ld 3x3 DFN	L10.3x3C
ISL9000IRGCZ	DLAA	2.7	1.8	-40 to +85	10 Ld 3x3 DFN	L10.3x3C
ISL9000IRFJZ	DGAA	2.5	2.8	-40 to +85	10 Ld 3x3 DFN	L10.3x3C
ISL9000IRFDZ	DCLA	2.5	2.0	-40 to +85	10 Ld 3x3 DFN	L10.3x3C
ISL9000IRFCZ	DCMA	2.5	1.8	-40 to +85	10 Ld 3x3 DFN	L10.3x3C
ISL9000IRPLZ	DKAA	1.85	2.9	-40 to +85	10 Ld 3x3 DFN	L10.3x3C
ISL9000IRPPZ	DABJ	1.85	1.85	-40 to +85	10 Ld 3x3 DFN	L10.3x3C
ISL9000IRCJZ	DCNA	1.8	2.8	-40 to +85	10 Ld 3x3 DFN	L10.3x3C
ISL9000IRCCZ	DCPA	1.8	1.8	-40 to +85	10 Ld 3x3 DFN	L10.3x3C
ISL9000IRBLZ	DABD	1.5	2.9	-40 to +85	10 Ld 3x3 DFN	L10.3x3C
ISL9000IRBJZ	DJAA	1.5	2.8	-40 to +85	10 Ld 3x3 DFN	L10.3x3C
ISL9000IRBCZ	DABC	1.5	1.8	-40 to +85	10 Ld 3x3 DFN	L10.3x3C
ISL9000IRBBZ	DABB	1.5	1.5	-40 to +85	10 Ld 3x3 DFN	L10.3x3C

NOTES:

1. Add "-T" suffix for tape and reel. Please refer to TB347 for details on reel specifications.
2. For other output voltages, contact Intersil Marketing.
3. These Intersil Pb-free plastic packaged products employ special Pb-free material sets; molding compounds/die attach materials and 100% matte tin plate PLUS ANNEAL - e3 termination finish, which is RoHS compliant and compatible with both SnPb and Pb-free soldering operations. Intersil Pb-free products are MSL classified at Pb-free peak reflow temperatures that meet or exceed the Pb-free requirements of IPC/JEDEC J STD-020.

Absolute Maximum Ratings

Supply Voltage (VIN)	+7.1V
VO1, VO2 Pins	+3.6V
All Other Pins	-0.3 to (VIN + 0.3)V

Recommended Operating Conditions

Ambient Temperature Range (TA)	-40°C to +85°C
Supply Voltage (VIN)	2.3V to 6.5V

Thermal Information

Thermal Resistance (Notes 4, 5)	θ_{JA} (°C/W)	θ_{JC} (°C/W)
10 Ld 3x3 DFN Package	50	10
Junction Temperature Range	-40°C to +125°C	
Operating Temperature Range	-40°C to +85°C	
Storage Temperature Range	-65°C to +150°C	
Pb-free Reflow Profile	see link below http://www.intersil.com/pbfree/Pb-FreeReflow.asp	

CAUTION: Do not operate at or near the maximum ratings listed for extended periods of time. Exposure to such conditions may adversely impact product reliability and result in failures not covered by warranty.

NOTES:

- θ_{JA} is measured in free air with the component mounted on a high effective thermal conductivity test board with "direct attach" features. See Tech Brief TB379.
- For θ_{JC} , the "case temp" location is the center of the exposed metal pad on the package underside.

Electrical Specifications

Unless otherwise noted, all parameters are guaranteed over the operational supply voltage and temperature range of the device as follows:

TA = -40°C to +85°C; VIN = (VO + 0.5V) to 6.5V with a minimum VIN of 2.3V; CIN = 1μF; CO = 1μF; CBYP = 0.01μF; CPOR = 0.01μF.

PARAMETER	SYMBOL	TEST CONDITIONS	MIN (Note 8)	TYP	MAX (Note 8)	UNITS
DC CHARACTERISTICS						
Supply Voltage	VIN		2.3		6.5	V
Ground Current		Quiescent condition: IO1 = 0μA; IO2 = 0μA				
	IDD1	One LDO active		25	32	μA
	IDD2	Both LDO active		42	52	μA
Shutdown Current	IDDS	@ +25°C		0.1	1.0	μA
UVLO Threshold	VUV+		1.9	2.1	2.3	V
	VUV-		1.6	1.8	2.0	V
Regulation Voltage Accuracy		Initial accuracy at VIN = VO + 0.5V, IO = 10mA, TJ = +25°C	-0.7		+0.7	%
		VIN = VO + 0.5V to 5.5V, IO = 10μA to 300mA, TJ = +25°C	-0.8		+0.8	%
		VIN = VO + 0.5V to 5.5V, IO = 10μA to 300mA, TJ = -40°C to +125°C	-1.8		+1.8	%
Maximum Output Current	IMAX	Continuous	300			mA
Internal Current Limit	LIM		350	475	600	mA
Dropout Voltage (Note 7)	VDO1	IO = 300mA; VO < 2.5V		300	500	mV
	VDO2	IO = 300mA; 2.5V ≤ VO ≤ 2.8V		250	400	mV
	VDO3	IO = 300mA; VO > 2.8V		200	325	mV
Thermal Shutdown Temperature	TSD+			145		°C
	TSD-			110		°C
AC CHARACTERISTICS						
Ripple Rejection (Note 6)		IO = 10mA, VIN = 2.8V(min), VO = 1.8V, CBYP = 0.1μF				
		@ 1kHz		90		dB
		@ 10kHz		70		dB
		@ 100kHz		50		dB
Output Noise Voltage (Note 6)		IO = 100μA, VO = 1.5V, TA = +25°C, CBYP = 0.1μF BW = 10Hz to 100kHz		30		μVRMS
DEVICE START-UP CHARACTERISTICS						

Electrical Specifications

Unless otherwise noted, all parameters are guaranteed over the operational supply voltage and temperature range of the device as follows:
 $T_A = -40^{\circ}\text{C}$ to $+85^{\circ}\text{C}$; $V_{IN} = (V_O + 0.5\text{V})$ to 6.5V with a minimum V_{IN} of 2.3V ; $C_{IN} = 1\mu\text{F}$; $C_O = 1\mu\text{F}$; $C_{BYP} = 0.01\mu\text{F}$; $C_{POR} = 0.01\mu\text{F}$. (Continued)

PARAMETER	SYMBOL	TEST CONDITIONS	MIN (Note 8)	TYP	MAX (Note 8)	UNITS
Device Enable Time	t_{EN}	Time from assertion of the ENx pin to when the output voltage reaches 95% of the $V_{O(nom)}$		250	500	μs
LDO Soft-Start Ramp Rate	t_{SSR}	Slope of linear portion of LDO output voltage ramp during start-up		30	60	$\mu\text{s}/\text{V}$
EN1, EN2 PIN CHARACTERISTICS						
Input Low Voltage	V_{IL}		-0.3		0.5	V
Input High Voltage	V_{IH}		1.4		$V_{IN} + 0.3$	V
Input Leakage Current	I_{IL}, I_{IH}				0.1	μA
Pin Capacitance	C_{PIN}	Informative		5		pF
POR1, POR2 PIN CHARACTERISTICS						
POR1, POR2 Thresholds	V_{POR+}	As a percentage of nominal output voltage	91	94	97	%
	V_{POR-}		87	90	93	%
POR1 Delay	t_{P1LH}		1.0	2.0	3.0	ms
	t_{P1HL}			25		μs
POR2 Delay	t_{P2LH}	$C_{POR} = 0.01\mu\text{F}$	100	200	300	ms
	t_{P2HL}			25		μs
POR1, POR2 Pin Output Low Voltage	V_{OL}	@ $I_{OL} = 1.0\text{mA}$			0.2	V
POR1, POR2 Pin Internal Pull-Up Resistance	R_{POR}		78	100	180	k Ω

NOTES:

6. Limits established by characterization and are not production tested.
7. $V_{OX} = 0.98 \cdot V_{OX(NOM)}$; Valid for V_{OX} greater than 1.85V.
8. Parts are 100% tested at +25°C. Temperature limits established by characterization and are not production tested.

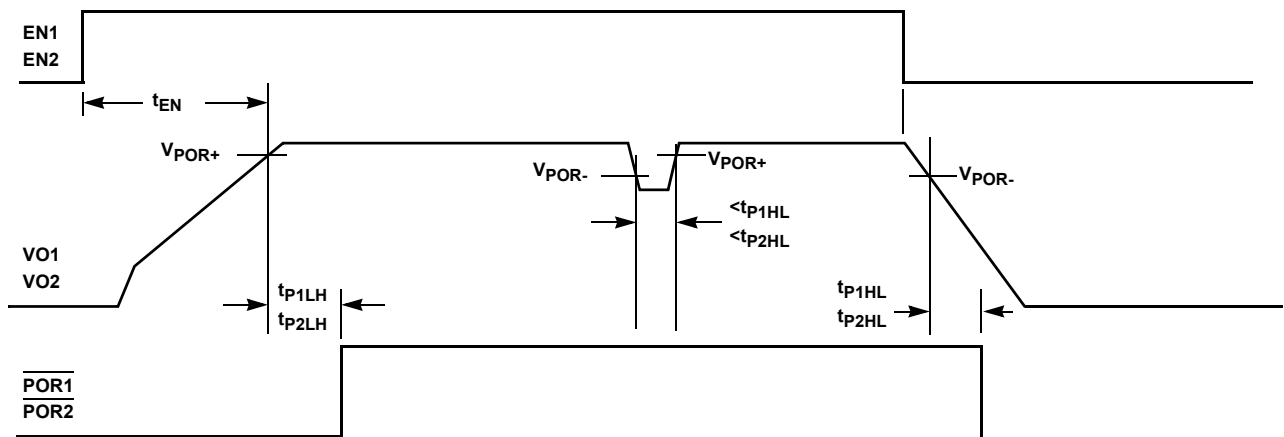

FIGURE 1. TIMING PARAMETER DEFINITION

Typical Performance Curves

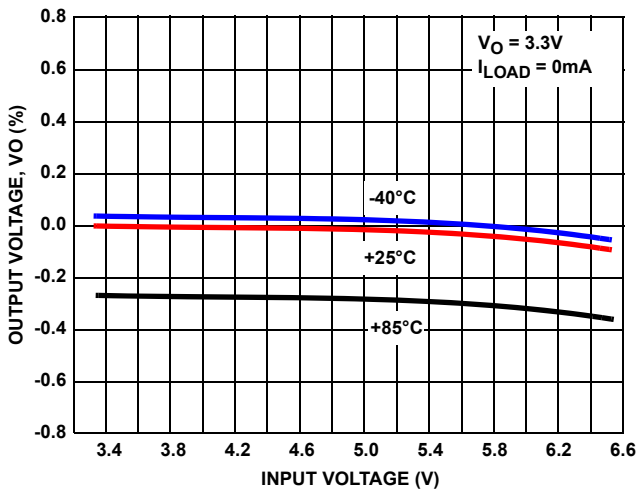

FIGURE 2. OUTPUT VOLTAGE vs INPUT VOLTAGE (3.3V OUTPUT)

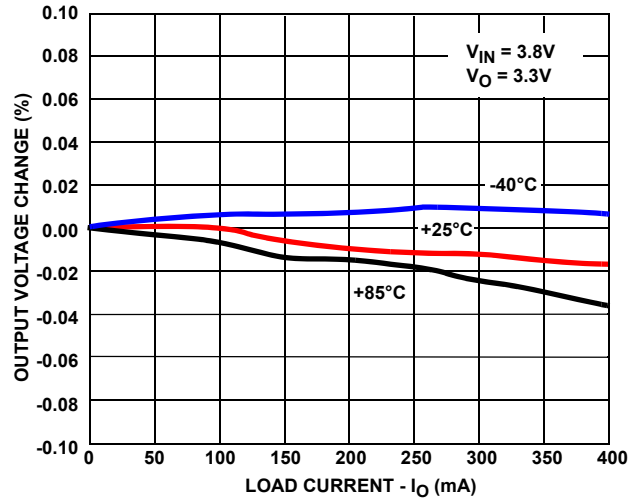

FIGURE 3. OUTPUT VOLTAGE CHANGE vs LOAD CURRENT

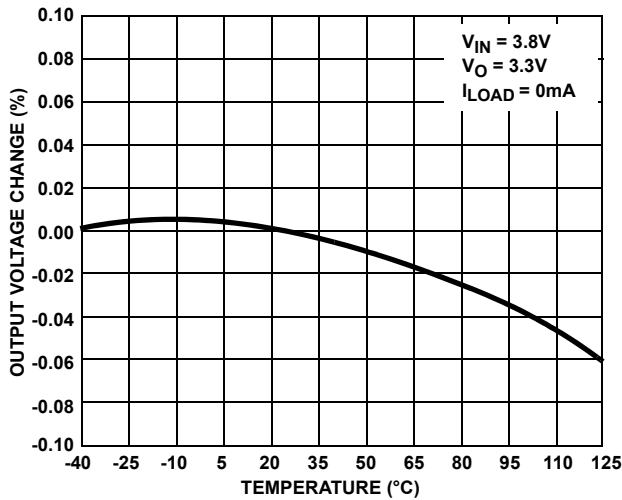

FIGURE 4. OUTPUT VOLTAGE CHANGE vs TEMPERATURE

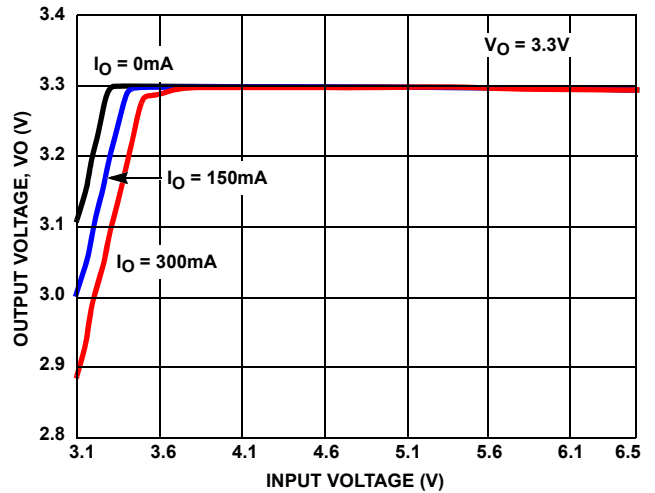

FIGURE 5. OUTPUT VOLTAGE vs INPUT VOLTAGE (3.3V OUTPUT)

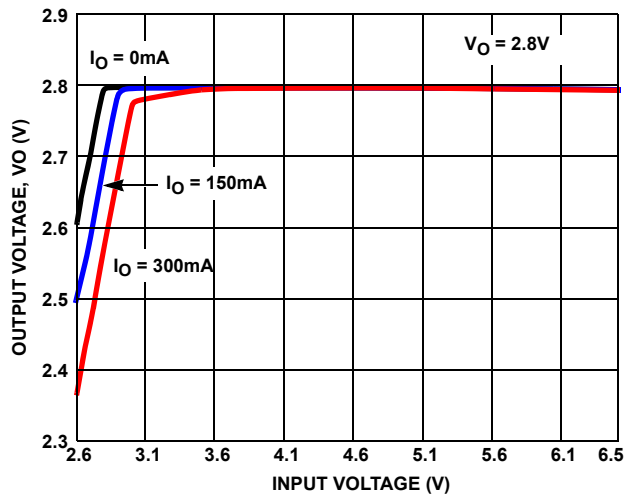

FIGURE 6. OUTPUT VOLTAGE vs INPUT VOLTAGE (2.8V OUTPUT)

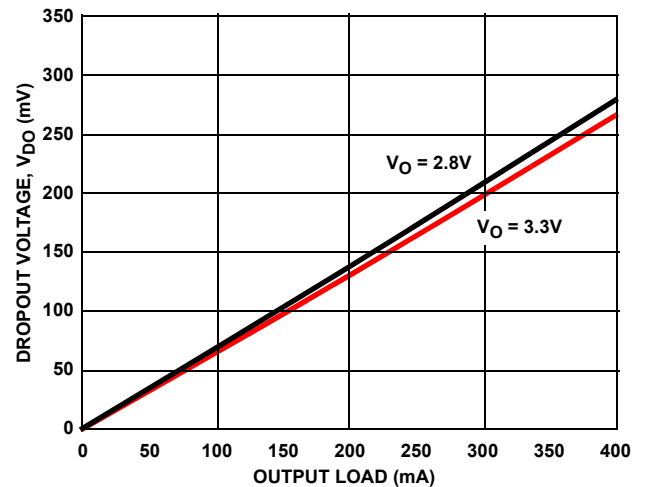

FIGURE 7. DROPOUT VOLTAGE vs LOAD CURRENT

Typical Performance Curves (Continued)

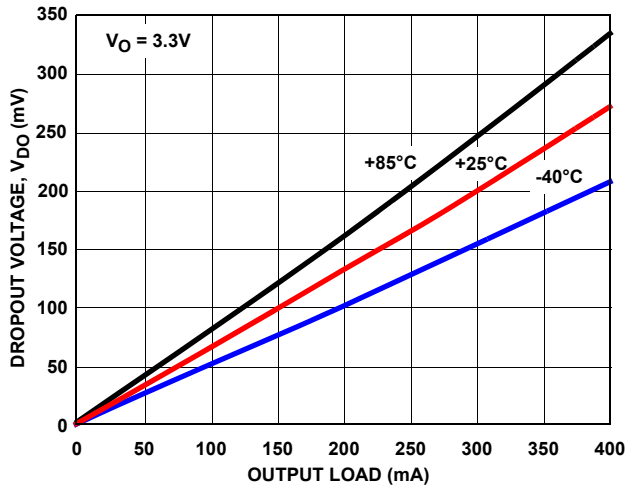

FIGURE 8. DROPOUT VOLTAGE vs LOAD CURRENT

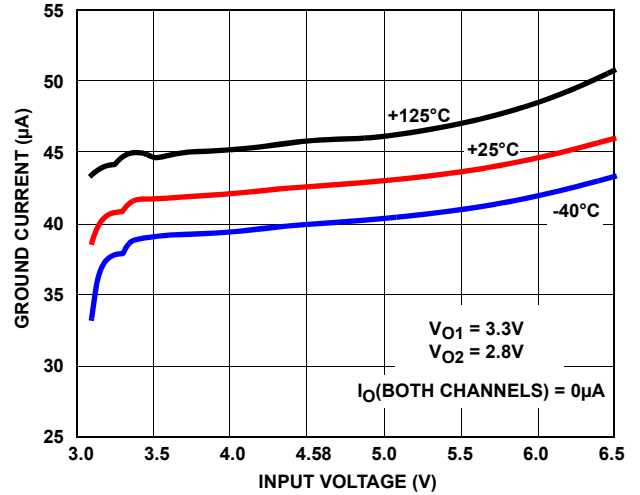

FIGURE 9. GROUND CURRENT vs INPUT VOLTAGE

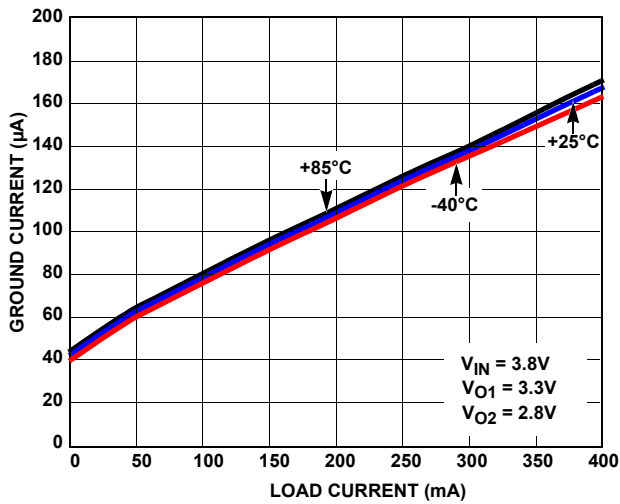

FIGURE 10. GROUND CURRENT vs LOAD

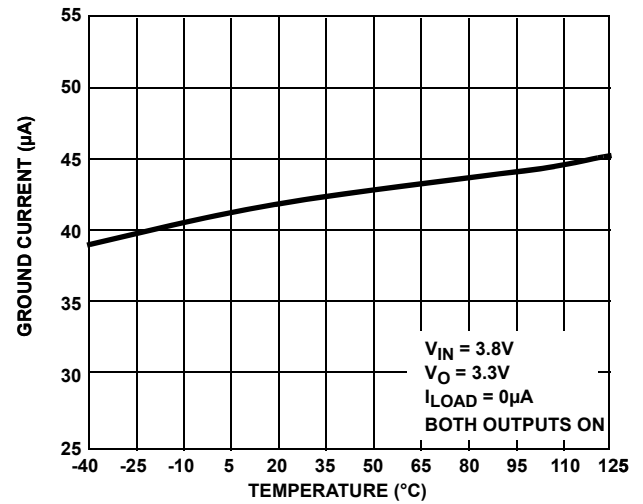

FIGURE 11. GROUND CURRENT vs TEMPERATURE

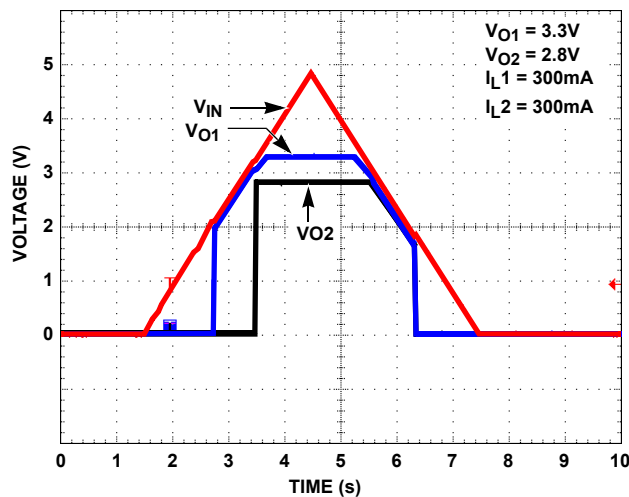

FIGURE 12. POWER-UP/POWER-DOWN

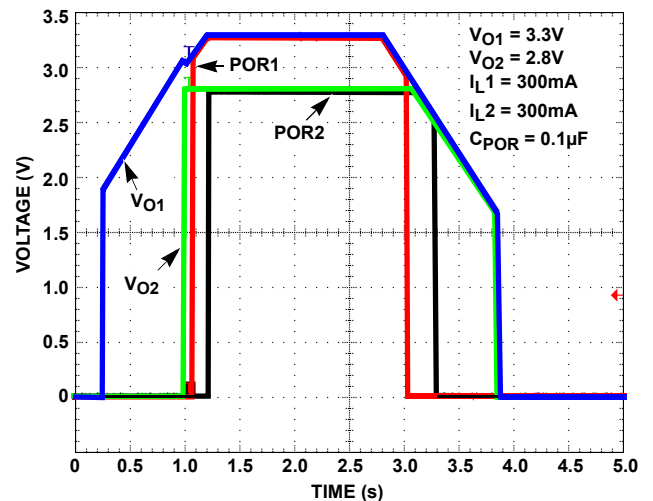

FIGURE 13. POWER-UP/POWER-DOWN WITH POR SIGNALS

Typical Performance Curves (Continued)

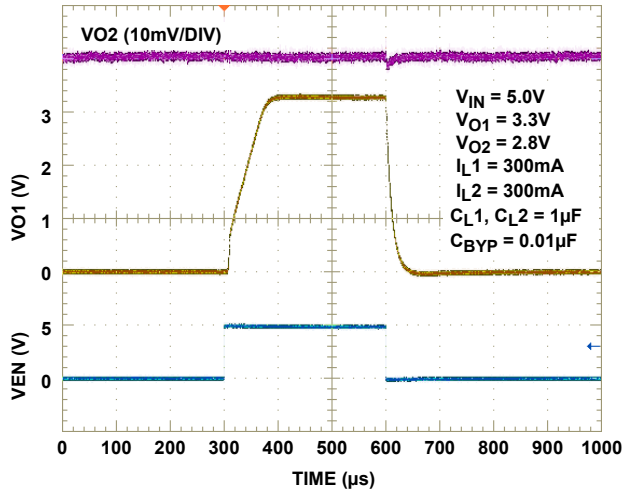

FIGURE 14. TURN ON/TURN OFF RESPONSE

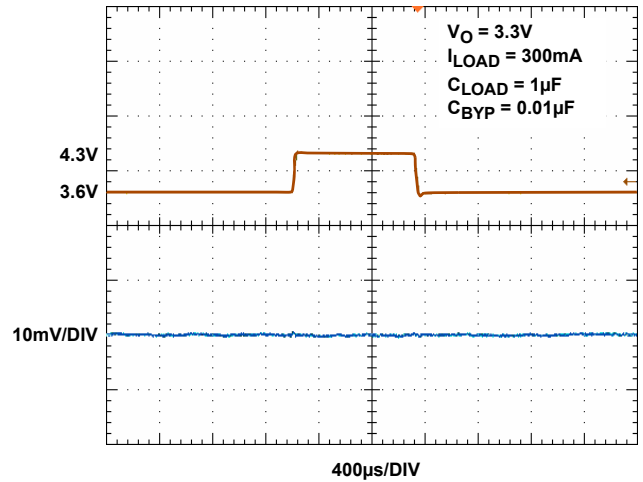

FIGURE 15. LINE TRANSIENT RESPONSE (3.3V OUTPUT)

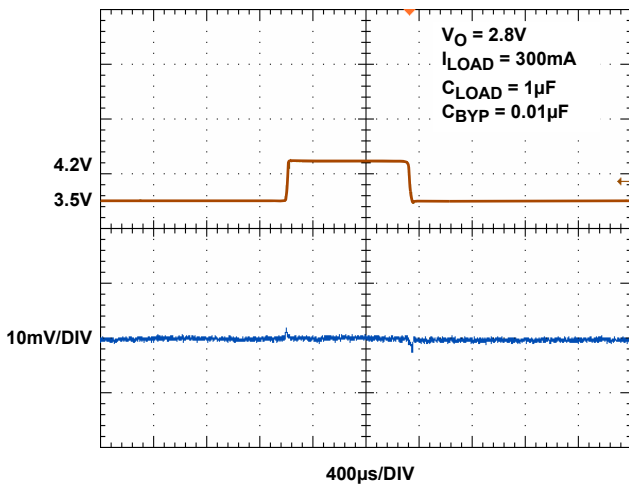

FIGURE 16. LINE TRANSIENT RESPONSE (2.8V OUTPUT)

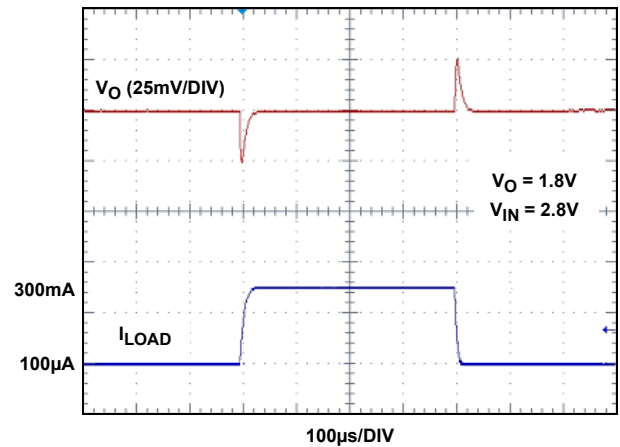

FIGURE 17. LOAD TRANSIENT RESPONSE

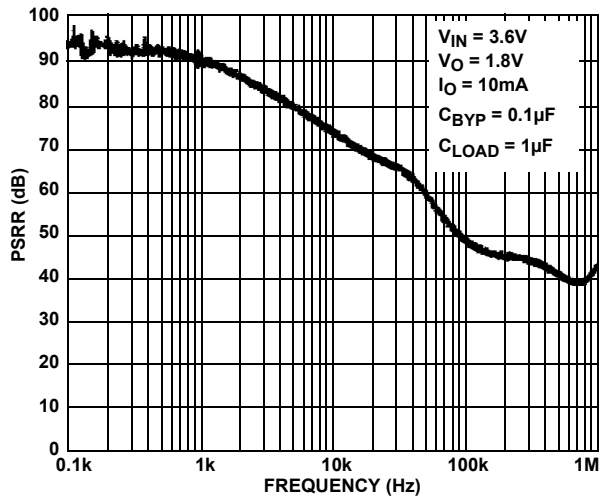

FIGURE 18. PSRR vs FREQUENCY

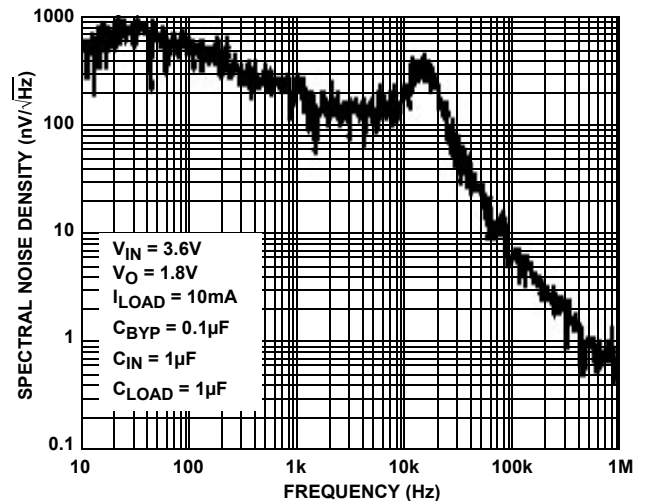
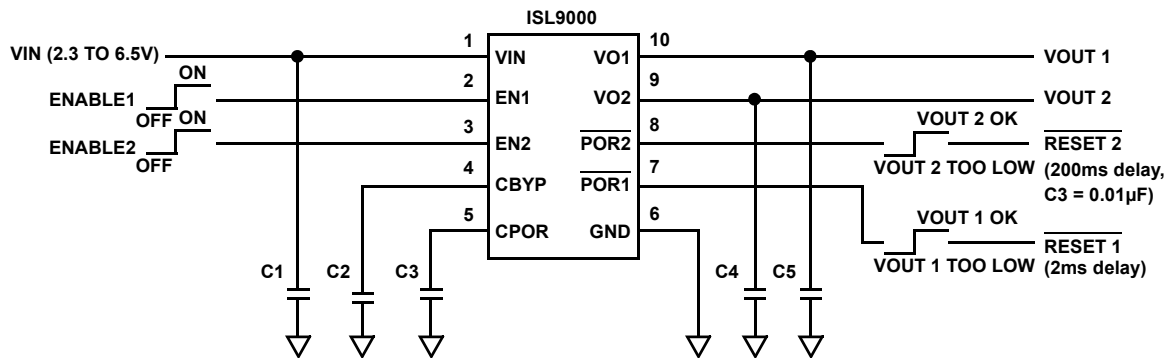

FIGURE 19. SPECTRAL NOISE DENSITY vs FREQUENCY

Pin Description

PIN NUMBER	PIN NAME	TYPE	DESCRIPTION
1	VIN	Analog I/O	Supply Voltage/LDO Input: Connect a 1μF capacitor to GND.
2	EN1	Low Voltage Compatible CMOS Input	LDO-1 Enable.
3	EN2	Low Voltage Compatible CMOS Input	LDO-2 Enable.
4	CBYP	Analog I/O	Reference Bypass Capacitor Pin: Optionally connect capacitor of value 0.01μF to 1μF between this pin and GND to tune in the desired noise and PSRR performance.
5	CPOR	Analog I/O	POR2 Delay Setting Capacitor Pin: Connect a capacitor between this pin and GND to delay the $\overline{\text{POR2}}$ output release after LDO-2 output reaches 94% of its specified voltage level. (200ms delay per 0.01μF).
6	GND	Ground	GND is the connection to system ground. Connect to PCB Ground plane.
7	$\overline{\text{POR1}}$	Open Drain Output (1mA)	Open-drain POR Output for LDO-1 (active-low): Internally connected to VO1 through 100kΩ resistor.
8	$\overline{\text{POR2}}$	Open Drain Output (1mA)	Open-drain POR Output for LDO-2 (active-low): Internally connected to VO2 through 100kΩ resistor.
9	VO2	Analog I/O	LDO-2 Output: Connect capacitor of value 1μF to 10μF to GND (1μF recommended).
10	VO1	Analog I/O	LDO-1 Output: Connect capacitor of value 1μF to 10μF to GND (1μF recommended).

Typical Application



C1, C4, C5: 1μF X5R ceramic capacitor
 C2: 0.1μF X7R ceramic capacitor
 C3: 0.01μF X7R ceramic capacitor

Block Diagram

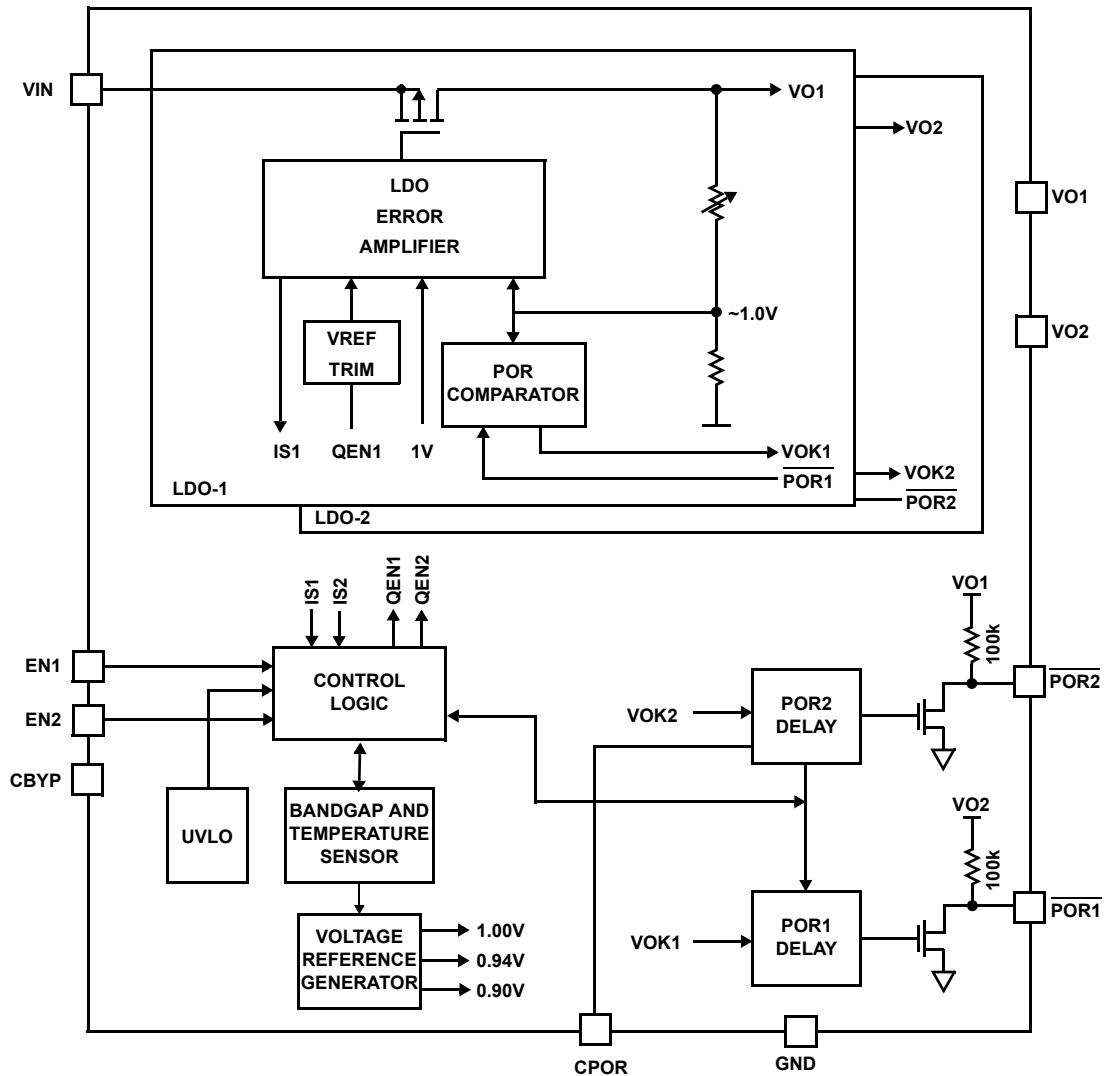

Functional Description

The ISL9000 contains two high performance LDOs. High performance is achieved through a circuit that delivers fast transient response to varying load conditions. In a quiescent condition, the ISL9000 adjusts its biasing to achieve the lowest standby current consumption.

The device also integrates current limit protection, smart thermal shutdown protection, staged turn-on and soft-start. Smart thermal shutdown protects the device against overheating. Staged turn-on and soft-start minimize start-up input current surges without causing excessive device turn-on time.

Power Control

The ISL9000 has two separate enable pins, EN1 and EN2, to individually control power to each of the LDO outputs. When both EN1 and EN2 are low, the device is in shutdown

mode. During this condition, all on-chip circuits are off, and the device draws minimum current, typically less than 0.1µA.

When one or both of the enable pins are asserted, the device first polls the output of the UVLO detector to ensure that VIN voltage is at least about 2.1V. Once verified, the device initiates a start-up sequence. During the start-up sequence, trim settings are first read and latched. Then, sequentially, the bandgap, reference voltage and current generation circuitry power-up. Once the references are stable, a fast-start circuit quickly charges the external reference bypass capacitor (connected to the CBYP pin) to the proper operating voltage. After the bypass capacitor has been charged, the LDOs power-up in their specified sequence.

Soft-start circuitry integrated into each LDO limits the initial ramp-up rate to about 30µs/V to minimize current surge.

If EN1 is brought high, and EN2 goes high before the VO1 output stabilizes, the ISL9000 delays the VO2 turn-on until the VO1 output reaches its target level.

If EN2 is brought high, and EN1 goes high before VO2 starts its output ramp, then VO1 turns on first and, the ISL9000 delays the VO2 turn-on until the VO1 output reaches its target level.

If EN2 is brought high, and EN1 goes high after VO2 starts its output ramp, then the ISL9000 immediately starts to ramp up the VO1 output.

If both EN1 and EN2 are brought high at the same time, the VO1 output has priority, and is always powered up first.

During operation, whenever the VIN voltage drops below about 1.8V, the ISL9000 immediately disables both LDO outputs. When VIN rises back above 2.1V, the device re-initiates its start-up sequence and LDO operation will resume automatically.

Reference Generation

The reference generation circuitry includes a trimmed bandgap, a trimmed voltage reference divider, a trimmed current reference generator, and an RC noise filter. The filter includes the external capacitor connected to the CBYP pin. A 0.01 μ F capacitor connected CBYP implements a 100Hz lowpass filter, and is recommended for most high performance applications. For the lowest noise application, a 0.1 μ F or greater CBYP capacitor should be used. This filters the reference noise below the 10Hz to 1kHz frequency band, which is crucial in many noise-sensitive applications.

The bandgap generates a zero temperature coefficient (TC) voltage for the reference divider. The reference divider provides the regulation reference, POR detection thresholds, and other voltage references required for current generation and over-temperature detection.

The current generator provides the references required for adaptive biasing as well as references for LDO output current limit and thermal shutdown determination.

LDO Regulation and Programmable Output Divider

The LDO Regulator is implemented with a high-gain operational amplifier driving a PMOS pass transistor. The design of the ISL9000 provides a regulator that has low quiescent current, fast transient response, and overall stability across all operating and load current conditions. LDO stability is guaranteed for a 1 μ F to 10 μ F output capacitor that has a tolerance better than 20% and ESR less than 200m Ω . The design is performance-optimized for a 1 μ F capacitor. Unless limited by the application, use of an output capacitor value above 4.7 μ F is not normally needed as LDO performance improvement is minimal.

Each LDO uses an independently trimmed 1V reference. An internal resistor divider drops the LDO output voltage down to 1V. This is compared to the 1V reference for regulation.

The resistor division ratio is programmed in the factory to one of the following output voltages: 1.5V, 1.8V, 1.85V, 2.5V, 2.6V, 2.7V, 2.8V, 2.85V, 2.9V, 3.0V, and 3.3V.

Power-On Reset Generation

Each LDO has a separate Power-on Reset signal generation circuit which outputs to the respective POR pins. The POR signal is generated as follows:

A POR comparator continuously monitors the output of each LDO. The LDO enters a power-good state when the output voltage is above 94% of the expected output voltage for a period exceeding the LDO PGOOD entry delay time (see the following). In the power-good state, the open-drain PORx output is in a high-impedance state. An internal 100k Ω pull-up resistor pulls the pin up to the respective LDO output voltage. An external resistor can be added between the PORx output and the LDO output for a faster rise time, however, the PORx output should not connect through an external resistor to a supply greater than the associated LDO voltage.

The power-good state is exited when the LDO output falls below 90% of the expected output voltage for a period longer than the PGOOD exit delay time. While power-good is false, the ISL9000 pulls the respective POR pin low.

For LDO-1, the PGOOD entry delay time is fixed at about 2ms while the PGOOD exit delay is about 25 μ s. For LDO-2, the PGOOD entry and exit delays are determined by the value of the external capacitor connected to the CPOR pin. For a 0.01 μ F capacitor, the entry and exit delays are 200ms and 25 μ s respectively. Larger or smaller capacitor values will yield proportionately longer or shorter delay times. The POR exit delay should never be allowed to be less than 10 μ s to ensure sufficient immunity against transient induced false POR triggering.

Overheat Detection

The bandgap provides a proportional-to-temperature current that is indicative of the temperature of the silicon. This current is compared with references to determine if the device is in danger of damage due to overheating. When the die temperature reaches about +145 $^{\circ}$ C, one or both of the LDOs momentarily shut down until the die cools sufficiently. In the overheat condition, only the LDO sourcing more than 50mA will be shut off. This does not affect the operation of the other LDO. If both LDOs source more than 50mA and an overheat condition occurs, both LDO outputs are disabled. Once the die temperature falls back below about +110 $^{\circ}$ C, the disabled LDO(s) are re-enabled and soft-start automatically takes place.

The ISL9000 provides short-circuit protection by limiting the output current to about 475mA. If short circuited, an output current of 475mA will cause die heating. If the short circuit lasts long enough, the overheat detection circuit will turn off the output.

Dual Flat No-Lead Plastic Package (DFN)

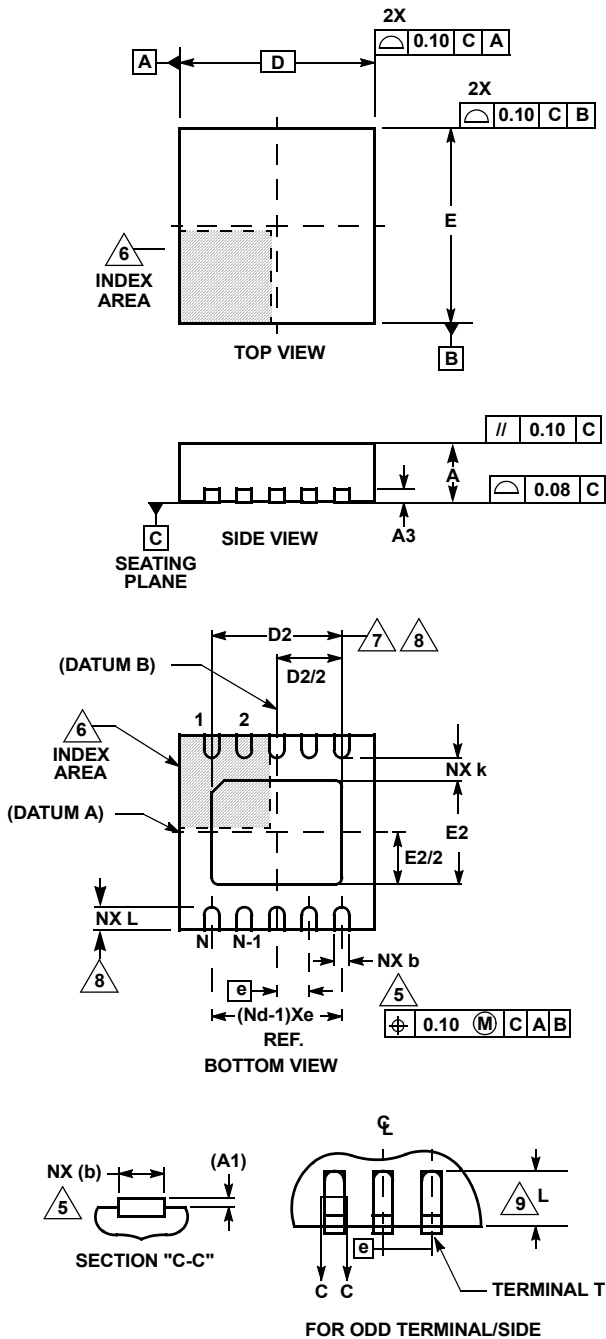

L10.3x3C

10 LEAD DUAL FLAT NO-LEAD PLASTIC PACKAGE

SYMBOL	MILLIMETERS			NOTES
	MIN	NOMINAL	MAX	
A	0.85	0.90	0.95	-
A1	-	-	0.05	-
A3	0.20 REF			-
b	0.20	0.25	0.30	5, 8
D	3.00 BSC			-
D2	2.33	2.38	2.43	7, 8
E	3.00 BSC			-
E2	1.59	1.64	1.69	7, 8
e	0.50 BSC			-
k	0.20	-	-	-
L	0.35	0.40	0.45	8
N	10			2
Nd	5			3

Rev. 1 4/06

NOTES:

1. Dimensioning and tolerancing conform to ASME Y14.5-1994.
2. N is the number of terminals.
3. Nd refers to the number of terminals on D.
4. All dimensions are in millimeters. Angles are in degrees.
5. Dimension b applies to the metallized terminal and is measured between 0.15mm and 0.30mm from the terminal tip.
6. The configuration of the pin #1 identifier is optional, but must be located within the zone indicated. The pin #1 identifier may be either a mold or mark feature.
7. Dimensions D2 and E2 are for the exposed pads which provide improved electrical and thermal performance.
8. Nominal dimensions are provided to assist with PCB Land Pattern Design efforts, see Intersil Technical Brief TB389.
9. COMPLIANT TO JEDEC MO-229-WEED-3 except for dimensions E2 & D2.

© Copyright Intersil Americas LLC 2005-2008. All Rights Reserved.

All trademarks and registered trademarks are the property of their respective owners.

For additional products, see www.intersil.com/en/products.html

Intersil products are manufactured, assembled and tested utilizing ISO9001 quality systems as noted in the quality certifications found at www.intersil.com/en/support/qualandreliability.html

Intersil products are sold by description only. Intersil may modify the circuit design and/or specifications of products at any time without notice, provided that such modification does not, in Intersil's sole judgment, affect the form, fit or function of the product. Accordingly, the reader is cautioned to verify that datasheets are current before placing orders. Information furnished by Intersil is believed to be accurate and reliable. However, no responsibility is assumed by Intersil or its subsidiaries for its use; nor for any infringements of patents or other rights of third parties which may result from its use. No license is granted by implication or otherwise under any patent or patent rights of Intersil or its subsidiaries.

For information regarding Intersil Corporation and its products, see www.intersil.com

X-ON Electronics

Largest Supplier of Electrical and Electronic Components

Click to view similar products for [LDO Voltage Regulators](#) category:

Click to view products by [Renesas](#) manufacturer:

Other Similar products are found below :

[M38D29FFHP#U1](#) [702103A](#) [717726C](#) [742457H](#) [MP20051DN-LF-Z](#) [R5F111PGGFB#30](#) [AP7363-SP-13](#) [NCP103AMX285TCG](#)
[NCV8664CST33T3G](#) [NCV8752AMX28TCG](#) [L9454](#) [AP7362-HA-7](#) [LX13043CLD](#) [TCR3DF185,LM\(CT](#) [TCR3DF24,LM\(CT](#)
[TCR3DF285,LM\(CT](#) [TCR3DF31,LM\(CT](#) [TCR3DF45,LM\(CT](#) [TLF4949EJ](#) [MP2013GQ-33-Z](#) [L9708](#) [L970813TR](#) [030014BB](#) [059985X](#)
[NCP121AMX173TCG](#) [NCP4687DH15T1G](#) [701326R](#) [702087BB](#) [755078E](#) [TCR2EN28,LF\(S](#) [LM1117DT-1.8/NO](#) [LT1086CM#TRPBF](#)
[AZ1085S2-1.5TRE1](#) [MAX15101EWL+T](#) [NCV8170AXV250T2G](#) [TCR3DF27,LM\(CT](#) [TCR3DF19,LM\(CT](#) [TCR3DF125,LM\(CT](#)
[TCR2EN18,LF\(S](#) [MAX15103EWL+T](#) [TS2937CZ-5.0 C0](#) [MAX8878EUK30-T](#) [MAX663CPA](#) [NCV4269CPD50R2G](#) [NCV8716MT30TBG](#)
[AZ1117IH-1.2TRG1](#) [MP2013GQ-P](#) [AP2112R5A-3.3TRG1](#) [AP7315-25W5-7](#) [MAX15102EWL+T](#)