

## RL78/G1D

R01DS0258EJ0130

### RENESAS MCU

Rev.1.30

Feb 23, 2018

The RL78/G1D is a microcontroller incorporating the RL78 CPU core and low power consumption RF transceiver supporting the Bluetooth ver.4.2 (Low Energy Single mode) specifications.

## 1. OUTLINE

### 1.1 Features

#### Low Power Technology (3.0V / MCU part: STOP )

- RF transmitter active: 4.3 mA (TYP.)
- RF receiver active: 3.5 mA (TYP.)
- RF sleep (POWER\_DOWN mode) operation: 0.3  $\mu$ A (TYP.)

#### On-Chip RF Transceiver

- <R> • Bluetooth v4.2 Specification (Low Energy Single mode)
- 2.4 GHz ISM Band, GFSK modulation, TDMA/TDD Frequency Hopping (included AES encryption circuit)
- Adaptivity, exclusively for use in operation as a slave device
- Single ended RF interface

#### 16-bit RL78-S2 CPU Core

- <R> • CISC Architecture (Harvard) with 3-stage pipeline
- Minimum instruction execution time: Can be changed from high speed (0.03125  $\mu$ s: @ 32 MHz operation with high-speed on-chip oscillator) to ultra-low speed (30.5  $\mu$ s: @ 32.768 kHz operation with subsystem clock)
- Multiply Signed & Unsigned: 16 x 16 to 32-bit result in 1 clock cycle
- 1-wire on-chip debug function

#### Main Flash Memory

- 128 KB / 192KB / 256 KB (Block size: 1 KB)
- On-chip single voltage flash memory with protection from block erase/writing
- Self-programming with secure boot swap function and flash shield window function

#### Data Flash Memory

- Data Flash with background operation
- Data flash size: 8 KB size (Erase block size: 1 KB)
- Erase Cycles: 1 Million (typ.)
- Erase/programming voltage: 1.8 V to 3.6 V

#### RAM

- 12 KB / 16KB / 20 KB size
- Supports operands or instructions
- Back-up retention in all modes

#### On-chip Oscillator

- High accuracy on-chip Oscillator for MCU
- 15kHz low-speed on-chip oscillator for MCU
- 32.768 kHz On-chip oscillator for the RF slow clock

#### Data Memory Access (DMA) Controller

- Up to 4 fully programmable channels
- Transfer unit: 8- or 16-bit

#### Multiple Communication Interfaces

- Simplified I<sup>2</sup>C×2
- CSI (7-, 8-bit) ×2,
- UART (7-, 8-, 9-bit) ×2
- I<sup>2</sup>C ×1

#### Supply voltage Management

- Low voltage detection (LVD) with 12 setting options (Notification to Interrupt and/or reset function)
- Power-on reset (POR) monitor/generator

#### Extended-Function Timers

- Multi-function 16-bit timers: 8 channels
- Real-time clock (RTC): 1 channel (full calendar and alarm function with watch correction function)
- Interval Timer: 12-bit, 1 channel
- Watchdog timer: 1 channel (window function)

#### Rich Analog

- 8/10-bit resolution A/D converter ( $V_{DD}$  = 1.6 to 3.6 V)
- Analog input: 8 channels
- Internal voltage reference (1.45 V) and temperature sensor<sup>Note</sup>

Note Can be selected only in HS (high-speed main) mode

#### Safety Functions

- Comply with the IEC60730 and IEC61508 safety standards

#### General Purpose I/O

- I/O port: 32 (N-ch open drain I/O [withstand voltage of 6 V]: 2, N-ch open drain I/O [VDD withstand voltage]: 9
- Different potential interface support: Can connect to a 1.8/2.5 V device

#### Standby function

- MCU part: Low power consumption mode: HALT, STOP  
Power saving mode: SNOOZE
- RF part :Low power saving mode with 6 setting (min. 0.1  $\mu$ A)

#### Operating Voltage / Operating Ambient Temperature

1.6 V to 3.6 V / -40 to +85°C

#### Package Type and Pin Count

48-pin HWQFN (6 × 6) (0.4mm pitch)

- ROM, RAM capacities

Flash ROM	Data Flash	RAM	RL78/G1D
128 KB	8 KB	12 KB	R5F11AGG
192 KB	8 KB	16 KB	R5F11AGH
256 KB	8 KB	20 KB <sup>Note</sup>	R5F11AGJ

**Note** 19 KB when the self-programming function is used.

1.2 List of Part Numbers

Figure 1-1. Part Number, Memory Size, and Package of RL78/G1D

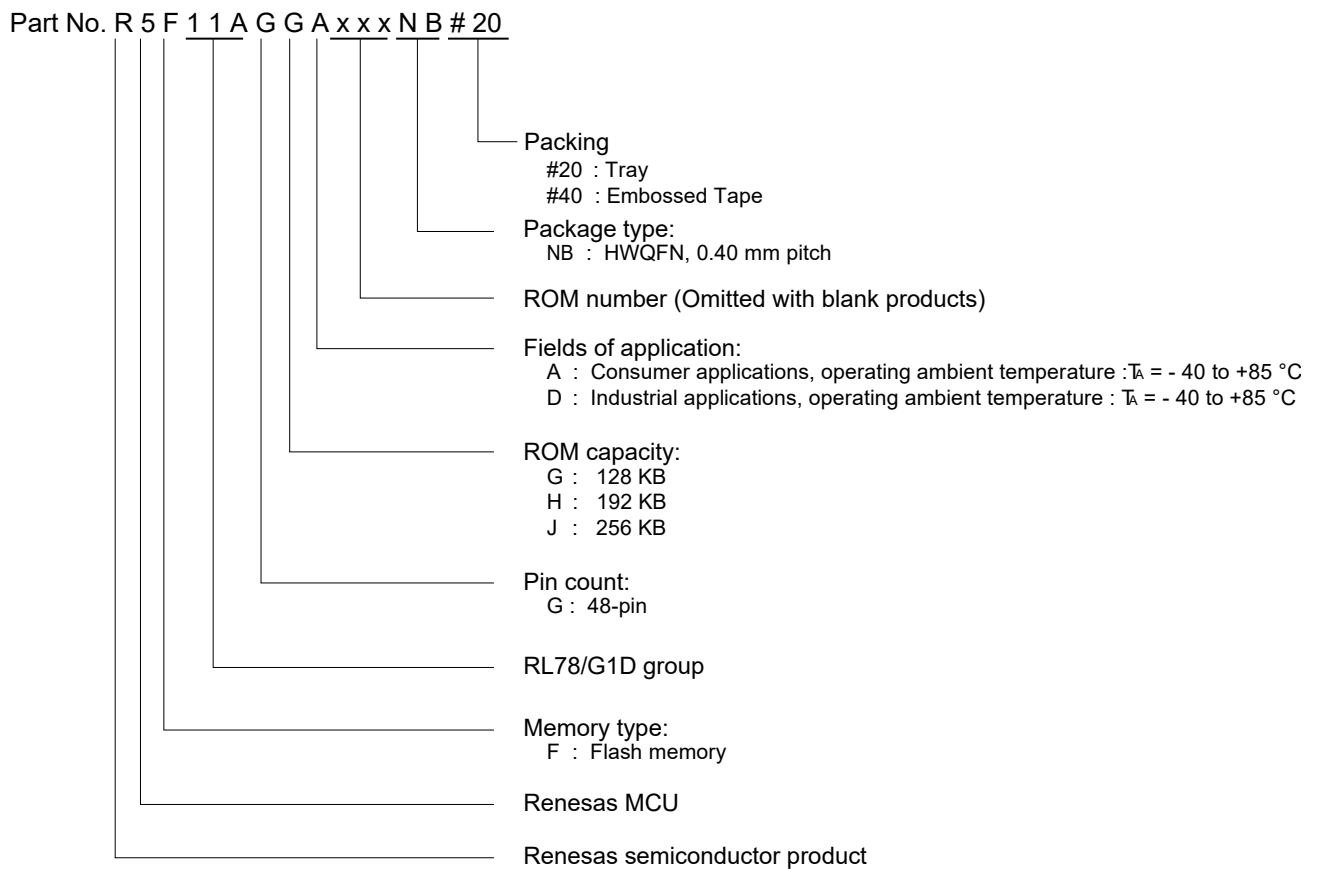

Table 1-1. List of Ordering Part Numbers

Pin count	Package	Fields of Application <sup>Note</sup>	Ordering Part Number	Code Flash Memory	Data Flash Memory
48 pins	Plastic WQFN (6 × 6)	A	R5F11AGGANB#20 R5F11AGGANB#40	128 KB	8 KB
		D	R5F11AGGDNB#20 R5F11AGGDNB#40		
		A	R5F11AGHANB#20 R5F11AGHANB#40	192 KB	8 KB
		D	R5F11AGHDNB#20 R5F11AGHDNB#40		
		A	R5F11AGJANB#20 R5F11AGJANB#40	256 KB	8 KB
		D	R5F11AGJDNB#20 R5F11AGJDNB#40		

**Note** For the fields of application, see **Figure 1-1 Part Number, Memory Size, and Package of RL78/G1D**.

**Caution** The ordering part numbers represent the numbers at the time of publication. For the latest ordering part numbers, refer to the target product page of the Renesas Electronics website.

### 1.3 Pin Configuration (Top View)

- 48-pin plastic WQFN (6 × 6 mm, 0.4 mm pitch)

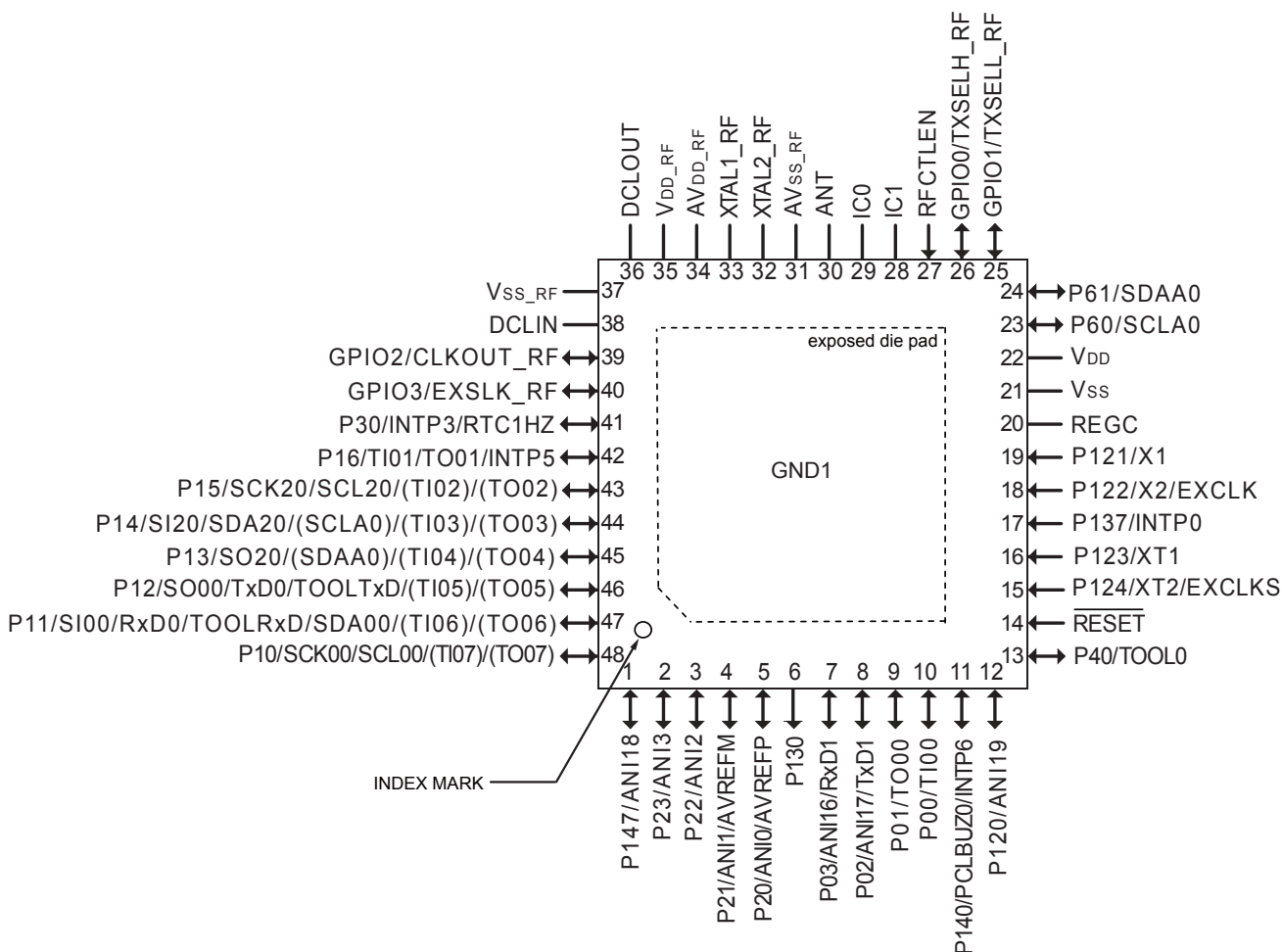

- Caution 1.** Connect the REGC pin to V<sub>SS</sub> via a capacitor (0.47 to 1 μF).
- 2.** Connect the metal pad (GND1) on the back of the package that has the same potential as AV<sub>SS\_RF</sub>.

- Remark 1.** For pin identification, see 1.4 Pin Identification.
- 2.** Functions in parentheses in the above figure can be assigned via settings in the peripheral I/O redirection register (PIOR)..

## 1.4 Pin Identification

ANI0 to ANI3, ANI16 to ANI19:	Analog input	PCLBUZ0:	Programmable clock output/buzzer output
ANT:	Antenna connection	REGC:	Regulator capacitance
AVDD_RF:	Power supply for RF analog	RFCTLEN:	RF control enable
AVREFM:	Analog reference voltage minus	RTC1HZ:	Real-time clock correction clock (1 Hz) output
AVREFP:	Analog reference voltage plus	RESET:	Reset
AVSS_RF:	Ground for RF analog	RxD0, RxD1:	Receive data
CLKOUT_RF:	Clock output	SCLA0:	Serial clock input/output
DCLIN:	DC-DC converter inductor and DCLOUT capacitor	SCK00, SCK20, SCL00, SCL20:	Serial clock output
DCLOUT:	DC-DC converter output	SDAA0, SDA00, SDA20:	Serial data input/output
EXCLK:	External clock input (Main system clock)	SI00, SI20:	Serial data input
EXCLKS:	External clock input (Subsystem clock)	SO00, SO20:	Serial data output
EXSLK_RF:	External slow clock input	TI00 to TI07:	Timer input
GND1:	Package exposed die pad	TO00 to TO07:	Timer output
GPIO0 to GPIO3:	GPIO at RF unit	TOOL0:	Data input/output for tool
IC0, IC1:	Internal circuit	TOOLRxD, TOOLTxD:	Data input/output for external device
INTP0, INTP3, INTP5, INTP6:	External interrupt input	TxD0, TxD1:	Transmit data
P00 to P03:	Port 0	TXSELL_RF, TXSELH_RF:	External PA/LNA control
P10 to P16:	Port 1	VDD:	Power supply
P20 to P23:	Port 2	VDD_RF:	Power Supply for RF
P30:	Port 3	VSS:	Ground
P40:	Port 4	VSS_RF:	Ground for RF
P60, P61:	Port 6	X1, X2:	Crystal oscillator (Main system clock)
P120 to P124:	Port 12	XT1, XT2:	Crystal oscillator (Subsystem clock)
P130, P137:	Port 13	XTAL1_RF, XTAL2_RF:	Crystal oscillator (RF clock)
P140, P147:	Port 14		

<R> 1.5 Block Diagram

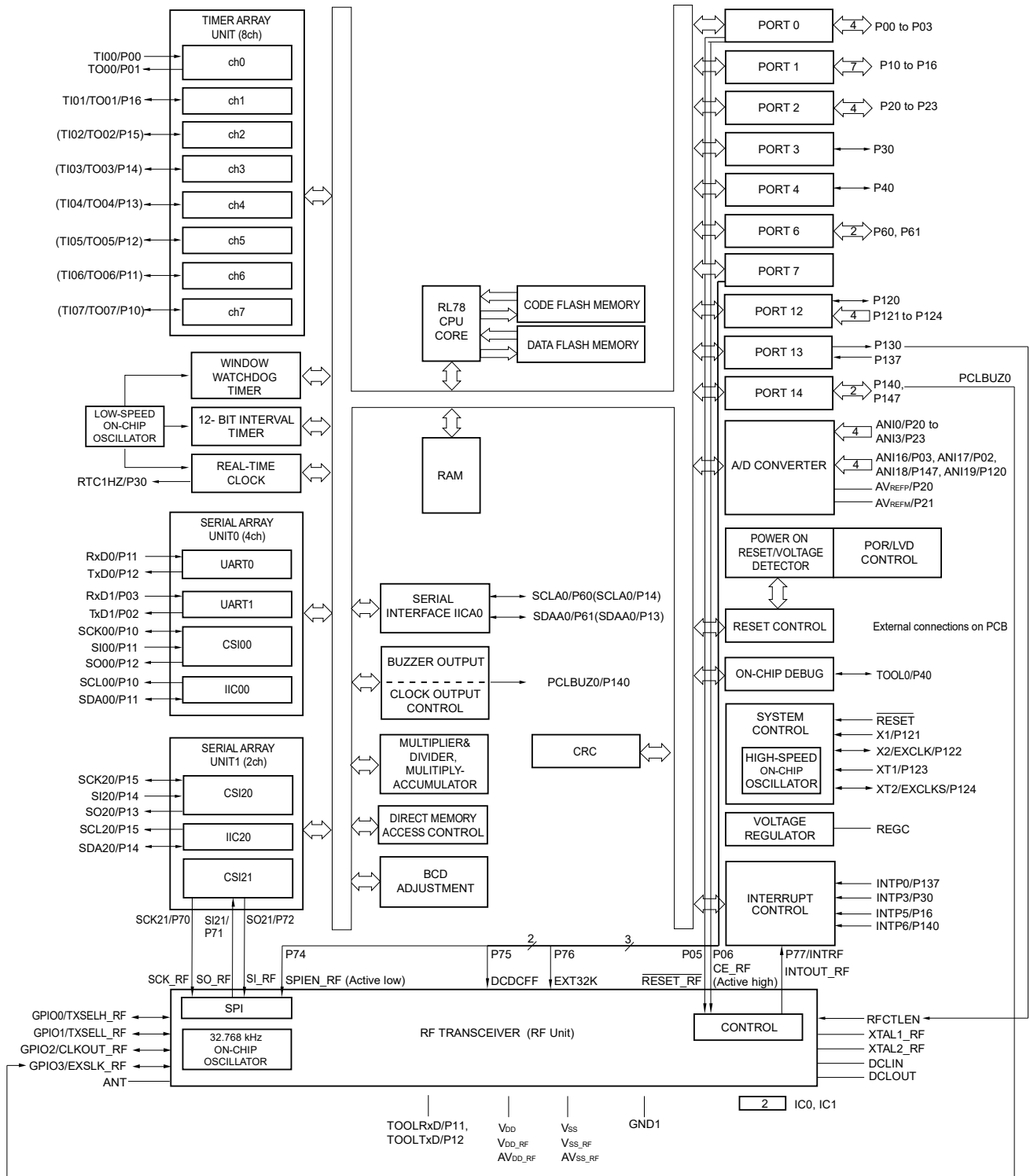

**Remark** Functions in parentheses in the above figure can be assigned via settings in the peripheral I/O redirection register (PIOR).

## 1.6 Outline of Functions

**Caution** This outline describes the functions at the time when Peripheral I/O redirection register (PIOR) is set to 00H.

(1/2)

Item		R5F11AGG	R5F11AGH	R5F11AGJ
Code flash memory		128 KB	192 KB	256 KB
Data flash memory		8 KB	8 KB	8 KB
RAM		12 KB	16 KB	20 KB <sup>Note 1</sup>
Address space		1 MB		
System clock (RF side)		32 MHz		
Main system clock	High-speed system clock	X1 (crystal/ceramic) oscillation, external main system clock input (EXCLK) HS (High-speed main) mode: 1 to 20 MHz ( $V_{DD} = 2.7$ to 3.6 V), HS (High-speed main) mode: 1 to 16 MHz ( $V_{DD} = 2.4$ to 3.6 V), LS (Low-speed main) mode: 1 to 8 MHz ( $V_{DD} = 1.8$ to 3.6 V), LV (Low-voltage main) mode: 1 to 4 MHz ( $V_{DD} = 1.6$ to 3.6 V)		
	High-speed on-chip oscillator	HS (High-speed main) mode: 1 to 32 MHz ( $V_{DD} = 2.7$ to 3.6 V), HS (High-speed main) mode: 1 to 16 MHz ( $V_{DD} = 2.4$ to 3.6 V), LS (Low-speed main) mode: 1 to 8 MHz ( $V_{DD} = 1.8$ to 3.6 V), LV (Low-voltage main) mode: 1 to 4 MHz ( $V_{DD} = 1.6$ to 3.6 V)		
Subsystem clock		XT1 (Crystal) oscillation, External main system clock input (EXCLKS) 32.768 kHz		
RF slow clock	External input	External clock input for RF block (EXSLK_RF) 32.768 kHz (TYP.)		
	On-chip Oscillator	32.768 kHz (TYP.)		
Low-speed on-chip oscillator		15 kHz (TYP.)		
General-purpose register		(8-bit register × 8) × 4 banks		
Minimum instruction execution time		0.03125 μs (High-speed on-chip oscillation clock: $f_{IH} = 32$ MHz operation)		
		0.05 μs (High-speed system clock: $f_{MX} = 20$ MHz operation)		
		30.5 μs (Subsystem clock: $f_{SUB} = 32.768$ kHz operation)		
Instruction set		<ul style="list-style-type: none"> <li>• Data transfer (8/16 bits)</li> <li>• Adder and subtractor/logical operation (8/16 bits)</li> <li>• Multiplication (8 bits × 8 bits)</li> <li>• Rotate, barrel shift, and bit manipulation (Set, reset, test, and Boolean operation), etc.</li> </ul>		
I/O port	Total	32 <sup>Note 2</sup>		
	CMOS I/O	20 <sup>Note 2</sup>		
	CMOS input	5 <sup>Note 2</sup>		
	CMOS output	1 <sup>Note 2</sup>		
	N-ch O.D. I/O (withstand voltage: 6 V)	2		
	GPIO (RF block)	4		
2.4 GHz RF transceiver		Supporting Bluetooth v4.2 Specification (Single mode). 2.4 GHz ISM Band, GFSK modulation, TDMA/TDD frequency hopping (Including AES encryption circuit.) Adaptivity (Only in slave operation)		
Timer	16-bit timer	8 channels		
	Watchdog timer	1 channel		
	Real-time clock (RTC)	1 channel		
	12-bit interval timer	1 channel		

(Notes are listed on the next page.)

- Note 1.** This is about 19 KB when the self-programming function is used.
2. When RF is used, this count includes the pins that connect the MCU with the RF transceiver by the user externally on the board.



(2/2)

Item		R5F11AGG	R5F11AGH	R5F11AGJ
Timer	Timer output	8 channels (PWM outputs: 7 <sup>Note 1</sup> Note 2)		
	RTC output	1 channel 1 Hz (subsystem clock: $f_{SUB} = 32.768$ kHz)		
Clock output/buzzer output		1 <sup>Note 3</sup>		
		<ul style="list-style-type: none"> <li>• 2.44 kHz, 4.88 kHz, 9.76 kHz, 1.25 MHz, 2.5 MHz, 5 MHz, 10 MHz (Main system clock: <math>f_{MAIN} = 20</math> MHz operation)</li> <li>• 256 Hz, 512 Hz, 1.024 kHz, 2.048 kHz, 4.096 kHz, 8.192 kHz, 16.384 kHz, 32.768 kHz (Subsystem clock: <math>f_{SUB} = 32.768</math> kHz operation)</li> </ul>		
	RF unit (Clock output)	<ul style="list-style-type: none"> <li>• 16 MHz, 8 MHz, 4 MHz</li> </ul>		
8/10-bit resolution A/D converter		8 channels		
Serial interface		<ul style="list-style-type: none"> <li>• CSI/simplified I<sup>2</sup>C/UART: 1 channel</li> <li>• CSI/simplified I<sup>2</sup>C: 1 channel</li> <li>• UART: 1 channel</li> <li>• CSI: 1 channel (dedicated for internal communications)</li> </ul>		
		I <sup>2</sup> C bus	1 channel	
Multiplier and divider/multiply-accumulator		Multiplication: 16 bits × 16 bits = 32 bits (Unsigned or signed) Division: 32 bits ÷ 32 bits = 32 bits (Unsigned) Multiply-accumulate: 16 bits × 16 bits + 32 bits = 32 bits (Unsigned or signed)		
DMA controller		4 channels		
Vectored interrupt sources	Internal	29		
	External	4		
Reset		<ul style="list-style-type: none"> <li>• Reset by RESET pin</li> <li>• Internal reset by watchdog timer</li> <li>• Internal reset by power-on-reset</li> <li>• Internal reset by voltage detector</li> <li>• Internal reset by illegal instruction execution<sup>Note 4</sup></li> <li>• Internal reset by RAM parity error</li> <li>• Internal reset by illegal-memory access</li> </ul>		
Power-on-reset circuit		<ul style="list-style-type: none"> <li>• Power-on-reset: 1.51 (TYP.)</li> <li>• Power-down-reset: 1.50 (TYP.)</li> </ul>		
Voltage detector		<ul style="list-style-type: none"> <li>• Rising edge : 1.67 V to 3.13 V (12 stages)</li> <li>• Falling edge : 1.63 V to 3.06 V (12 stages)</li> </ul>		
On-chip debug function		Provided		
Power supply voltage		$V_{DD} = 1.6$ to $3.6$ V ( $V_{DD} = 1.8$ to $3.6$ V on usage of DC-DC converter)		
Operating ambient temperature		$T_A = -40$ to $+85$ °C		
Package		48-pin QFN (6 × 6), (0.4 mm pitch)		

**Note 1.** The number of outputs varies, depending on the setting of channels in use and the number of the master (see **7.9.3 Operation as multiple PWM output function**).

**2.** When setting to  $PIOR0 = 1$

**3.** When RF is used, this count includes the pins that connect the MCU with the RF transceiver by the user externally on the board.

**4.** The illegal instruction is generated when instruction code FFH is executed. Reset by the illegal instruction execution not issued by emulation with the on-chip debug emulator.

## 2. ELECTRICAL SPECIFICATIONS

**Caution** The RL78 microcontrollers have an on-chip debug function, which is provided for development and evaluation. Do not use the on-chip debug function in products designated for mass production, because the guaranteed number of rewritable times of the flash memory may be exceeded when this function is used, and product reliability therefore cannot be guaranteed. Renesas Electronics is not liable for problems occurring when the on-chip debug function is used.

## 2.1 Absolute Maximum Ratings

### Absolute Maximum Ratings (T<sub>A</sub> = 25°C) (1/2)

Parameter	Symbols	Conditions	Ratings	Unit
Supply voltage	V <sub>DD</sub>	V <sub>DD</sub>	-0.5 to +6.5	V
	V <sub>DDRF1</sub>	V <sub>DD_RF</sub>	-0.5 to +4.0	V
	V <sub>DDRF2</sub>	AV <sub>DD_RF</sub>	-0.5 to +4.0	V
	V <sub>DDRF3</sub>	DCLIN	-0.5 to +4.0	V
	V <sub>SSRF</sub>	V <sub>SS_RF</sub> , AV <sub>SS_RF</sub>	-0.5 to +0.3	V
Input voltage	V <sub>I1</sub>	P00, P01, P02, P03, P10, P11, P12, P14, P15, P16, P20, P21, P22, P23, P30, P40, P120, P121, P122, P123, P124, P137, P140, P147, RESET	-0.3 to V <sub>DD</sub> +0.3 <sup>Note 1</sup>	V
	V <sub>I2</sub>	P60, P61	-0.3 to +6.5	V
	V <sub>IRF1</sub>	GPIO0, GPIO1, GPIO2, GPIO3	-0.3 to V <sub>DD_RF</sub> +0.3 <sup>Note 2</sup>	V
	V <sub>IRF2</sub>	ANT	-0.5 to +1.4	V
Output voltage	V <sub>O</sub>	P00, P01, P02, P03, P10, P11, P12, P14, P15, P16, P20, P21, P22, P23, P30, P40, P60, P61, P120, P130, P140, P147	-0.3 to V <sub>DD</sub> +0.3 <sup>Note 1</sup>	V
	V <sub>ORF</sub>	GPIO0, GPIO1, GPIO2, GPIO3, DCLOUT	-0.3 to V <sub>DD_RF</sub> +0.3 <sup>Note 2</sup>	V
Analog input voltage	V <sub>AI</sub>	ANI0, ANI1, ANI2, ANI3, ANI16, ANI17, ANI18, ANI19	-0.3 to V <sub>DD</sub> +0.3 and -0.3 to V <sub>REF(+)</sub> +0.3 <sup>Note 2, 4</sup>	V
REGC pin input voltage	V <sub>IREGC</sub>	REGC	-0.3 to +2.8 and -0.3 to V <sub>DD</sub> +0.3 <sup>Note 3</sup>	V
IC pin input voltage	V <sub>IIC</sub>	IC0, IC1	-0.5 to +0.3	V

**Note 1.** Must be 6.5 V or lower.

**2.** Must be 4.0 V or lower.

**3.** Connect the REGC pin to V<sub>SS</sub> via a capacitor (0.47 to 1 μF). This value regulates the absolute maximum rating of the REGC pin. Do not use this pin with voltage applied to it.

**4.** Do not exceed AV<sub>REF(+)</sub> + 0.3 V in case of A/D conversion target pin.

**Caution** Product quality may suffer if the absolute maximum rating is exceeded even momentarily for any parameter. That is, the absolute maximum ratings are rated values at which the product is on the verge of suffering physical damage, and therefore the product must be used under conditions that ensure that the absolute maximum ratings are not exceeded.

**Remark 1.** Unless specified otherwise, the characteristics of alternate-function pins are the same as those of the port pins.

**2.** AV<sub>REF(+)</sub> : + side reference voltage of the A/D converter.

**3.** Reference voltage is V<sub>SS</sub>.

**Absolute Maximum Ratings (T<sub>A</sub> = 25°C) (2/2)**

Parameter	Symbols	Conditions	Ratings	Unit	
Output current, high	I <sub>OH1</sub>	Per pin	(This is applicable to all pins listed below.)	-40	mA
		Total of all pins -170mA	P00, P01, P02, P03, P40, P120, P130, P140	-70	mA
			P10, P11, P12, P13, P14, P15, P16, P30, P147	-100	mA
	I <sub>OH2</sub>	Per pin	(This is applicable to all pins listed below.)	-0.5	mA
		Total of all pins	P20, P21, P22, P23	-2	mA
	I <sub>OHMRF</sub>	Per pin	GPIO0, GPIO1, GPIO2, GPIO3	-17	mA
Output current, low	I <sub>OL1</sub>	Per pin	(This is applicable to all pins listed below.)	40	mA
		Total of all pins 170mA	P00, P01, P02, P03, P40, P120, P130, P140	70	mA
			P10, P11, P12, P13, P14, P15, P16, P30, P60, P61, P147	100	mA
	I <sub>OL2</sub>	Per pin	(This is applicable to all pins listed below.)	1	mA
		Total of all pins	P20, P21, P22, P23	5	mA
	I <sub>OLRF</sub>	Per pin	GPIO0, GPIO1, GPIO2, GPIO3	17	mA
Operating ambient temperature	T <sub>A</sub>	In normal operation mode	-40 to +85	°C	
		In flash memory programming mode	-40 to +85	°C	
Storage temperature	T <sub>stg</sub>		-65 to +150	°C	

**Caution** Product quality may suffer if the absolute maximum rating is exceeded even momentarily for any parameter. That is, the absolute maximum ratings are rated values at which the product is on the verge of suffering physical damage, and therefore the product must be used under conditions that ensure that the absolute maximum ratings are not exceeded.

**Remark 1.** Unless specified otherwise, the characteristics of alternate-function pins are the same as those of the port pins.

2. AV<sub>REF (+)</sub> : + side reference voltage of the A/D converter.
3. Reference voltage is V<sub>SS</sub>.

## 2.2 Operating Voltage

( $T_A = -40$  to  $+85^\circ\text{C}$ ,  $V_{DD} = V_{DD\_RF} = AV_{DD\_RF}$ ,  $V_{SS} = V_{SS\_RF} = AV_{SS\_RF} = 0$  V)

Clock generator		Flash operation mode	Operation voltage	CPU operation clocks ( $f_{CLK}$ ) <sup>Note 1</sup>		
Main system clock ( $f_{MAIN}$ )	High-speed on-chip oscillator ( $f_{IH}$ )	HS (high-speed main) mode	$2.7\text{ V} \leq V_{DD} \leq 3.6\text{ V}$	1 MHz to 32 MHz		
			$2.4\text{ V} \leq V_{DD} < 2.7\text{ V}$	1 MHz to 16 MHz		
		LS (low-speed main) mode	$1.8\text{ V} \leq V_{DD} \leq 3.6\text{ V}$	1 MHz to 8 MHz		
	X1 clock oscillator ( $f_X$ )	HS (high-speed main) mode	LV (low-voltage main) mode <sup>Note 2</sup>	$1.6\text{ V} \leq V_{DD} \leq 3.6\text{ V}$	1 MHz to 4 MHz	
			HS (high-speed main) mode	$2.7\text{ V} \leq V_{DD} \leq 3.6\text{ V}$	1 MHz to 20 MHz	
			LS (low-speed main) mode	$1.8\text{ V} \leq V_{DD} \leq 3.6\text{ V}$	1 MHz to 8 MHz	
		External main system clock ( $f_{EX}$ )	HS (high-speed main) mode	LV (low-voltage main) mode <sup>Note 2</sup>	$1.6\text{ V} \leq V_{DD} \leq 3.6\text{ V}$	1 MHz to 4 MHz
				$2.7\text{ V} \leq V_{DD} \leq 3.6\text{ V}$	1 MHz to 20 MHz	
			LS (low-speed main) mode	$1.8\text{ V} \leq V_{DD} \leq 3.6\text{ V}$	1 MHz to 8 MHz	
Subsystem clock ( $f_{SUB}$ )	XT1 clock oscillator ( $f_{XT}$ )	–	$1.6\text{ V} \leq V_{DD} \leq 3.6\text{ V}$	32.768 kHz		
	External subsystem clock ( $f_{EXT}$ )	–	$1.6\text{ V} \leq V_{DD} \leq 3.6\text{ V}$	32.768 kHz		

**Note 1.** Indicates only permissible oscillator frequency ranges. Refer to AC Characteristics for instruction execution time. Request evaluation by the manufacturer of the oscillator circuit mounted on a board to check the oscillator characteristics.

**2.** This mode is prohibited to use in case of using DC-DC converter.

### 2.3 Oscillator Characteristics

#### 2.3.1 X1, XT1, XRF oscillator characteristics

( $T_A = -40$  to  $+85^\circ\text{C}$ ,  $1.6\text{ V} \leq V_{DD} = V_{DD\_RF} = AV_{DD\_RF} \leq 3.6\text{ V}$ ,  $V_{SS} = V_{SS\_RF} = AV_{SS\_RF} = 0\text{ V}$ )

Parameter		Symbol	Conditions	MIN.	TYP.	MAX.	Unit
X1 clock oscillation frequency <sup>Note 1</sup>	Ceramic resonator	$f_x$	$2.7\text{ V} \leq V_{DD} \leq 3.6\text{ V}$	1		20	MHz
	Crystal resonator		$1.8\text{ V} \leq V_{DD} < 2.7\text{ V}$	1		8	MHz
			$1.6\text{ V} \leq V_{DD} \leq 1.8\text{ V}$	1		4	MHz
XT1 clock oscillation frequency <sup>Note 1</sup>		$f_{XT}$		32	32.768	35	kHz
RF base clock oscillation frequency <sup>Note 2</sup>		$f_{XRF}$			32		MHz
RF base clock oscillation frequency accuracy <sup>Note 2</sup>		$f_{XRFP}$		-20		+20	ppm

**Note 1.** Indicates only permissible oscillator frequency ranges. Refer to AC Characteristics for instruction execution time.

Request evaluation by the manufacturer of the oscillator circuit mounted on a board to check the oscillator characteristics.

2. This Oscillator characteristics is base clock for RF Transceiver.

**Caution** Since the CPU is started by the high-speed on-chip oscillator clock after a reset release, check the X1 clock oscillation stabilization time using the oscillation stabilization time counter status register (OSTC) by the user.

Determine the oscillation stabilization time of the OSTC register and the oscillation stabilization time select register (OSTS) after sufficiently evaluating the oscillation stabilization time with the resonator to be used.

#### 2.3.2 On-chip oscillator characteristics

( $T_A = -40$  to  $+85^\circ\text{C}$ ,  $1.6\text{ V} \leq V_{DD} = V_{DD\_RF} = AV_{DD\_RF} \leq 3.6\text{ V}$ ,  $V_{SS} = V_{SS\_RF} = AV_{SS\_RF} = 0\text{ V}$ )

Oscillators	Symbol	Conditions		MIN.	TYP.	MAX.	Unit
High-speed on-chip oscillator clock frequency <sup>Note 1, 2</sup>	$f_{IH}$			1		32	MHz
High-speed on-chip oscillator clock frequency accuracy	$f_{IHP}$	-20 to $+85^\circ\text{C}$	$1.8\text{ V} \leq V_{DD} \leq 3.6\text{ V}$	-1.5		+1.5	%
			$1.6\text{ V} \leq V_{DD} < 1.8\text{ V}$	-5.0		+5.0	%
		-40 to $-20^\circ\text{C}$	$1.8\text{ V} \leq V_{DD} \leq 3.6\text{ V}$	-2.5		+2.5	%
			$1.6\text{ V} \leq V_{DD} < 1.8\text{ V}$	-5.5		+5.5	%
Low-speed on-chip oscillator clock frequency <sup>Note 3</sup>	$f_{IL}$				15		kHz
Low-speed on-chip oscillator clock frequency accuracy	$f_{ILP}$			-15		+15	%
On-chip oscillator clock frequency for the RF slow clock <sup>Note 3</sup>	$f_{ILRF}$				32.768		kHz
On-chip oscillator clock frequency accuracy for the RF slow clock	$f_{ILRFP}$			-0.025		0.025	%

**Note 1.** High-speed on-chip oscillator frequency is selected by bits 0 to 3 of option byte (000C2H/010C2H) and bits 0 to 2 of HOCODIV register.

2. This indicates the oscillator characteristics only. Refer to AC Characteristics for instruction execution time.

3. This indicates the oscillator characteristics only.

## 2.4 DC Characteristics

### 2.4.1 Output current

( $T_A = -40$  to  $+85^\circ\text{C}$ ,  $1.6\text{ V} \leq V_{DD} = V_{DD\_RF} = AV_{DD\_RF} \leq 3.6\text{ V}$ ,  $V_{SS} = V_{SS\_RF} = AV_{SS\_RF} = 0\text{ V}$ )

Items	Symbol	Conditions	MIN.	TYP.	MAX.	Unit	
Output current, high <sup>Note 1</sup>	I <sub>OH1</sub>	P00, P01, P02, P03, P10, P11, P12, P13, P14, P15, P16, P30, P40, P120, P130, P140, P147	Per pin	$1.6\text{ V} \leq V_{DD} \leq 3.6\text{ V}$		$-10.0^{\text{Note 2}}$	mA
		P00, P01, P02, P03, P40, P120, P130, P140	Total <sup>Note 3</sup>	$2.7\text{ V} \leq V_{DD} \leq 3.6\text{ V}$		-10.0	mA
				$1.8\text{ V} \leq V_{DD} < 2.7\text{ V}$		-5.0	mA
				$1.6\text{ V} \leq V_{DD} < 1.8\text{ V}$		-2.5	mA
	P10, P11, P12, P13, P14, P15, P16, P30, P147	Total <sup>Note 3</sup>	$2.7\text{ V} \leq V_{DD} \leq 3.6\text{ V}$		-19.0	mA	
			$1.8\text{ V} \leq V_{DD} < 2.7\text{ V}$		-10.0	mA	
			$1.6\text{ V} \leq V_{DD} < 1.8\text{ V}$		-5.0	mA	
	Total of all pins <sup>Note 3</sup>		$1.6\text{ V} \leq V_{DD} \leq 3.6\text{ V}$			$-135.0^{\text{Note 4}}$	mA
	I <sub>OH2</sub>	P20, P21, P22, P23	Per pin	$1.6\text{ V} \leq V_{DD} \leq 3.6\text{ V}$		$-0.1^{\text{Note 2}}$	mA
			Total <sup>Note 3</sup>	$1.6\text{ V} \leq V_{DD} \leq 3.6\text{ V}$		-1.5	mA
I <sub>OH<sub>RF</sub></sub>	GPIO0, GPIO1, GPIO2, GPIO3	Per pin	$1.6\text{ V} \leq V_{DD\_RF} \leq 3.6\text{ V}$		-2.0	mA	
Output current, low <sup>Note 1</sup>	I <sub>OL1</sub>	P00, P01, P02, P03, P10, P11, P12, P13, P14, P15, P16, P30, P40, P120, P130, P140, P147	Per pin	$1.6\text{ V} \leq V_{DD} \leq 3.6\text{ V}$		$20.0^{\text{Note 2}}$	mA
		P60, P61	Per pin	$1.6\text{ V} \leq V_{DD} \leq 3.6\text{ V}$		$15.0^{\text{Note 2}}$	mA
		P00, P01, P02, P03, P40, P120, P130, P140	Total <sup>Note 3</sup>	$2.7\text{ V} \leq V_{DD} \leq 3.6\text{ V}$		15.0	mA
				$1.8\text{ V} \leq V_{DD} < 2.7\text{ V}$		9.0	mA
	$1.6\text{ V} \leq V_{DD} < 1.8\text{ V}$				4.5	mA	
	P10, P11, P12, P13, P14, P15, P16, P30, P60, P61, P147	Total <sup>Note 3</sup>	$2.7\text{ V} \leq V_{DD} \leq 3.6\text{ V}$		35.0	mA	
			$1.8\text{ V} \leq V_{DD} < 2.7\text{ V}$		20.0	mA	
			$1.6\text{ V} \leq V_{DD} < 1.8\text{ V}$		10.0	mA	
	Total of all pins <sup>Note 3</sup>		$1.6\text{ V} \leq V_{DD} \leq 3.6\text{ V}$			150.0	mA
	I <sub>OL2</sub>	P20, P21, P22, P23	Per pin	$1.6\text{ V} \leq V_{DD} \leq 3.6\text{ V}$		$0.4^{\text{Note 2}}$	mA
Total <sup>Note 3</sup>			$1.6\text{ V} \leq V_{DD} \leq 3.6\text{ V}$		5.0	mA	
I <sub>OL<sub>RF</sub></sub>	GPIO0, GPIO1, GPIO2, GPIO3	Per pin	$1.6\text{ V} \leq V_{DD\_RF} \leq 3.6\text{ V}$		2.0	mA	

**Note 1.** Value of current at which the device operation is guaranteed even if the current flows from the  $V_{DD}$  pin to an output pin.

- However, do not exceed the total current value.
- Specification under conditions where the duty factor  $\leq 70\%$ .

The output current value that has changed to the duty factor  $> 70\%$  the duty ratio can be calculated with the following expression (when changing the duty factor from 70% to n%).

- Total output current of pins =  $(I_{OH} \times 0.7)/(n \times 0.01)$

<Example> Where  $n = 50\%$  and  $I_{OH} = -10.0\text{ mA}$

$$\text{Total output current of pins} = (-10.0 \times 0.7)/(50 \times 0.01) = -14.0\text{ mA}$$

However, the current that is allowed to flow into one pin does not vary depending on the duty factor. A current higher than the absolute maximum rating must not flow into one pin.

- Product for industrial applications (R5F11AGGDNB, R5F11AGHDNB, R5F11AGJDNB) is  $-100.0\text{ mA}$ .

(Caution and Remark are listed on the next page.)

**Caution** P00, P02, P03, and P10 to P15 do not output high level in N-ch open-drain mode.

**Remark** Unless specified otherwise, the characteristics of alternate-function pins are the same as those of the port pins.

### 2.4.2 Input current

( $T_A = -40$  to  $+85^\circ\text{C}$ ,  $1.6\text{ V} \leq V_{DD} = V_{DD\_RF} = AV_{DD\_RF} \leq 3.6\text{ V}$ ,  $V_{SS} = V_{SS\_RF} = AV_{SS\_RF} = 0\text{ V}$ )

Items	Symbol	Conditions	MIN.	TYP.	MAX.	Unit	
Input voltage, high	$V_{IH1}$	P00, P01, P02, P03, P10, P11, P12, P13, P14, P15, P16, P30, P40, P120, P130, P140, P147	Normal mode ( $I_{THL} = 1$ )	$0.8V_{DD}$		$V_{DD}$	V
	$V_{IH2}$	P01, P03, P10, P11, P13, P14, P15, P16	TTL mode $3.3\text{ V} \leq V_{DD} \leq 3.6\text{ V}$	2.0		$V_{DD}$	V
			TTL mode $1.6\text{ V} \leq V_{DD} < 3.3\text{ V}$	1.5		$V_{DD}$	V
	$V_{IH3}$	P20, P21, P22, P23		$0.7V_{DD}$		$V_{DD}$	V
	$V_{IH4}$	P60, P61		$0.7V_{DD}$		6.0	V
	$V_{IH5}$	P121, P122, P123, P124, P137, RESET		$0.8V_{DD}$		$V_{DD}$	V
	$V_{IHRF}$	GPIO0, GPIO1, GPIO2, GPIO3		$0.85V_{DD\_RF}$		$V_{DD\_RF}$	V
Input voltage, low	$V_{IL1}$	P00, P01, P02, P03, P10, P11, P12, P13, P14, P15, P16, P30, P40, P120, P140, P147	Normal mode ( $I_{THL} = 1$ )	0		$0.2V_{DD}$	V
	$V_{IL2}$	P01, P03, P10, P11, P13, P14, P15, P16	TTL mode $3.3\text{ V} \leq V_{DD} \leq 3.6\text{ V}$	0		0.5	V
			TTL mode $1.6\text{ V} \leq V_{DD} < 3.3\text{ V}$	0		0.32	V
	$V_{IL3}$	P20, P21, P22, P23		0		$0.3V_{DD}$	V
	$V_{IL4}$	P60, P61		0		$0.3V_{DD}$	V
	$V_{IL5}$	P121, P122, P123, P124, P137, RESET		0		$0.2V_{DD}$	V
	$V_{ILRF}$	GPIO0, GPIO1, GPIO2, GPIO3		0		$0.1V_{DD\_RF}$	V

**Caution** The maximum value of  $V_{IH}$  of pins P00, P02, P03, and P10 to P15 is  $V_{DD}$ , even in the N-ch open-drain mode.

**Remark** Unless specified otherwise, the characteristics of alternate-function pins are the same as those of the port pins.



## 2.4.3 Output voltage

( $T_A = -40$  to  $+85^\circ\text{C}$ ,  $1.6\text{ V} \leq V_{DD} = V_{DD\_RF} = AV_{DD\_RF} \leq 3.6\text{ V}$ ,  $V_{SS} = V_{SS\_RF} = AV_{SS\_RF} = 0\text{ V}$ )

Items	Symbol	Conditions		MIN.	TYP.	MAX.	Unit
Output voltage, high	V <sub>OH1</sub>	I <sub>OH</sub> = -2.0 mA	P00, P01, P02, P03, P10, P11, P12, P13, P14, P15, P16, P30, P40, P120, P140, P147	2.7 V ≤ V <sub>DD</sub> ≤ 3.6 V		V <sub>DD</sub> - 0.6	V
		I <sub>OH</sub> = -1.5 mA		1.8 V ≤ V <sub>DD</sub> ≤ 3.6 V		V <sub>DD</sub> - 0.5	V
		I <sub>OH</sub> = -1.0 mA		1.6 V ≤ V <sub>DD</sub> ≤ 3.6 V		V <sub>DD</sub> - 0.5	V
		I <sub>OH</sub> = -10 μA	P130			V <sub>DD</sub> - 0.3	V
	V <sub>OH2</sub>	I <sub>OH</sub> = -100 μA	P20, P21, P22, P23			V <sub>DD</sub> - 0.5	V
	V <sub>OH<sub>RF</sub></sub>	I <sub>OH</sub> = -2.0 mA	GPIO0, GPIO1, GPIO2, GPIO3	2.7 V ≤ V <sub>DD<sub>RF</sub></sub> ≤ 3.6 V		V <sub>DD<sub>RF</sub></sub> - 0.3	V
I <sub>OH</sub> = -1.5 mA			1.8 V ≤ V <sub>DD<sub>RF</sub></sub> ≤ 3.6 V		V <sub>DD<sub>RF</sub></sub> - 0.3	V	
Output voltage, low	V <sub>OL1</sub>	I <sub>OL</sub> = 3.0 mA	P00, P01, P02, P03, P10, P11, P12, P13, P14, P15, P16, P30, P40, P120, P130, P140, P147	2.7 V ≤ V <sub>DD</sub> ≤ 3.6 V		0.6	V
		I <sub>OL</sub> = 1.5 mA				0.4	V
		I <sub>OL</sub> = 0.6 mA		1.8 V ≤ V <sub>DD</sub> ≤ 3.6 V		0.4	V
		I <sub>OL</sub> = 0.3 mA		1.6 V ≤ V <sub>DD</sub> ≤ 3.6 V		0.4	V
	V <sub>OL2</sub>	I <sub>OL</sub> = 400 μA	P20, P21, P22, P23			0.4	V
	V <sub>OL<sub>RF</sub></sub>		GPIO0, GPIO1, GPIO2, GPIO3			0.3	V

**Caution** P00, P02, P03, and P10 to P15 do not output high level in N-ch open-drain mode.

**Remark** Unless specified otherwise, the characteristics of alternate-function pins are the same as those of the port pins.

## 2.4.4 Input leakage current

( $T_A = -40$  to  $+85^\circ\text{C}$ ,  $1.6\text{ V} \leq V_{DD} = V_{DD\_RF} = AV_{DD\_RF} \leq 3.6\text{ V}$ ,  $V_{SS} = V_{SS\_RF} = AV_{SS\_RF} = 0\text{ V}$ )

Items	Symbol	Conditions		MIN.	TYP.	MAX.	Unit	
Input leakage current, high	ILIH1	$V_I = V_{DD}$	P00, P01, P02, P03, P10, P11, P12, P13, P14, P15, P16, P30, P40, P60, P61, P120, P140, P147			1	$\mu\text{A}$	
	ILIH2	$V_I = V_{DD}$	P20, P21, P22, P23, P137, $\overline{\text{RESET}}$			1	$\mu\text{A}$	
	ILIH3	$V_I = V_{DD}$	P121, P122, P123, P124 (EXCLK, EXCLKS) (XT1, XT2)	In input port			1	$\mu\text{A}$
				In external clock input			1	$\mu\text{A}$
				In resonator connection			10	$\mu\text{A}$
ILHRF	$V_I = V_{DD\_RF}$	GPIO0, GPIO1, GPIO2, GPIO3				10	$\mu\text{A}$	
Input leakage current, low	ILIL1	$V_I = V_{SS}$	P00, P01, P02, P03, P10, P11, P12, P13, P14, P15, P16, P30, P40, P60, P61, P120, P140, P147			-1	$\mu\text{A}$	
	ILIL2	$V_I = V_{SS}$	P20, P21, P22, P23, P137, $\overline{\text{RESET}}$			-1	$\mu\text{A}$	
	ILIL3	$V_I = V_{SS}$	P121, P122, P123, P124 (EXCLK, EXCLKS) (XT1, XT2)	In input port			-1	$\mu\text{A}$
				In external clock input			-1	$\mu\text{A}$
				In resonator connection			-10	$\mu\text{A}$
ILILRF	$V_I = V_{SS\_RF}$	GPIO0, GPIO1, GPIO2, GPIO3				-10	$\mu\text{A}$	

**Remark** Unless specified otherwise, the characteristics of alternate-function pins are the same as those of the port pins.

## 2.4.5 Resistance

( $T_A = -40$  to  $+85^\circ\text{C}$ ,  $1.6\text{ V} \leq V_{DD} = V_{DD\_RF} = AV_{DD\_RF} \leq 3.6\text{ V}$ ,  $V_{SS} = V_{SS\_RF} = AV_{SS\_RF} = 0\text{ V}$ )

Items	Symbol	Conditions		MIN.	TYP.	MAX.	Unit
On-chip pll-up resistance	Ru	$V_I = V_{SS}$	P00, P01, P02, P03, P10, P11, P12, P13, P14, P15, P16, P30, P40, P120, P140, P147 In input mode	10	20	100	$\text{k}\Omega$

**Remark** Unless specified otherwise, the characteristics of alternate-function pins are the same as those of the port pins.

2.5 Current Consumption

The Current Consumption by the RL78/G1D is the total current including that for the MCU (current flowing into the V<sub>DD</sub> pin) and that for the RF unit (current flowing into the V<sub>DD\_RF</sub>, AV<sub>DD\_RF</sub> pins).

The characteristics of the MCU (current flowing into the V<sub>DD</sub> pin) are given in 2.5.1 and the characteristics of the RF unit (current flowing into the V<sub>DD\_RF</sub>/AV<sub>DD\_RF</sub> pins) are given in 2.5.2

2.5.1 MCU

(1) Operating current

(T<sub>A</sub> = -40 to +85°C, 1.6 V ≤ V<sub>DD</sub> = V<sub>DD\_RF</sub> = AV<sub>DD\_RF</sub> ≤ 3.6 V, V<sub>SS</sub> = V<sub>SS\_RF</sub> = AV<sub>SS\_RF</sub> = 0 V)

Parameter	Symbol	Conditions			MIN.	TYP.	MAX.	Unit		
Operating current <sup>Note 1</sup>	I <sub>DD1</sub>	HS (high-speed main) mode <sup>Note 5</sup>	Basic operation	f <sub>IH</sub> = 32 MHz <sup>Note 2</sup>	V <sub>DD</sub> = 3.0 V		2.3		mA	
			Normal operation	f <sub>IH</sub> = 32 MHz <sup>Note 2</sup>	V <sub>DD</sub> = 3.0 V		5.2	8.5	mA	
				f <sub>IH</sub> = 24 MHz <sup>Note 2</sup>	V <sub>DD</sub> = 3.0 V		4.1	6.6	mA	
				f <sub>IH</sub> = 16 MHz <sup>Note 2</sup>	V <sub>DD</sub> = 3.0 V		3.0	4.7	mA	
		LS (low-speed main) mode <sup>Note 5</sup>	Normal operation	f <sub>IH</sub> = 8 MHz <sup>Note 2</sup>	V <sub>DD</sub> = 3.0 V		1.3	2.1	mA	
					V <sub>DD</sub> = 2.0 V		1.3	2.1	mA	
		LV (low-voltage main) mode <sup>Note 5</sup>	Normal operation	f <sub>IH</sub> = 4 MHz <sup>Note 2</sup>	V <sub>DD</sub> = 3.0 V		1.3	1.8	mA	
					V <sub>DD</sub> = 2.0 V		1.3	1.8	mA	
		HS (high-speed main) mode <sup>Note 5</sup>	Normal operation	f <sub>MX</sub> = 20 MHz <sup>Note 3</sup>	V <sub>DD</sub> = 3.0 V <sup>Note 6</sup>		3.4	5.5	mA	
							3.6	5.7	mA	
						f <sub>MX</sub> = 10 MHz <sup>Note 3</sup>	V <sub>DD</sub> = 3.0 V <sup>Note 6</sup>		2.1	3.2
		LS (low-speed main) mode <sup>Note 5</sup>	Normal operation	f <sub>MX</sub> = 8 MHz <sup>Note 3</sup>	V <sub>DD</sub> = 3.0 V <sup>Note 6</sup>		1.2	2.0	mA	
							1.2	2.0	mA	
					V <sub>DD</sub> = 2.0 V <sup>Note 6</sup>		1.2	2.0	mA	
							1.2	2.0	mA	
		Subsystem clock operation	Normal operation	f <sub>SUB</sub> = 32.768 kHz <sup>Note 4</sup>	T <sub>A</sub> = -40°C <sup>Note 6</sup>		4.8	5.9	μA	
							4.9	6.0	μA	
						T <sub>A</sub> = +25°C <sup>Note 6</sup>		4.9	5.9	μA
							5.0	6.0	μA	
						T <sub>A</sub> = +50°C <sup>Note 6</sup>		5.0	7.6	μA
							5.1	7.7	μA	
T <sub>A</sub> = +70°C <sup>Note 6</sup>						5.2	9.3	μA		
	5.3	9.4	μA							
	T <sub>A</sub> = +85°C <sup>Note 6</sup>		5.7	13.3	μA					
			5.8	13.4	μA					

(Notes and Remarks are listed on the next page.)

- Note 1.** Current flowing into  $V_{DD}$ , including the input leakage current flowing when the level of the input pin is fixed to  $V_{DD}$  or  $V_{SS}$ . The values below the MAX. column include the peripheral operation current. However, not including the current flowing into the A/D converter, LVD circuit, I/O port, and on-chip pull-up/pull-down resistors and the current flowing during data flash rewrite.
2. When high-speed system clock and subsystem clock are stopped.
  3. When high-speed on-chip oscillator and subsystem clock are stopped.
  4. When high-speed on-chip oscillator and high-speed system clock are stopped. When setting ultra-low current consumption (AMPHS1 = 1). Not including the current flowing into the RTC, 12-bit interval timer, and watchdog timer.
  5. Relationship between operation voltage width, operation frequency of CPU and operation mode is as below.  
HS (high-speed main) mode:  $2.7\text{ V} \leq V_{DD} \leq 3.6\text{ V}@1\text{ MHz to }32\text{ MHz}$   
 $2.4\text{ V} \leq V_{DD} \leq 3.6\text{ V}@1\text{ MHz to }16\text{ MHz}$   
LS (low-speed main) mode:  $1.8\text{ V} \leq V_{DD} \leq 3.6\text{ V}@1\text{ MHz to }8\text{ MHz}$   
LV (low-voltage main) mode:  $1.6\text{ V} \leq V_{DD} \leq 3.6\text{ V}@1\text{ MHz to }4\text{ MHz}$
  6. The upper value is for square-wave input and the lower is with an oscillator connected.

- Remark 1.**  $f_{MX}$ : High-speed system clock frequency (External main system clock frequency)
2.  $f_{IH}$ : High-speed on-chip oscillator clock frequency
  3.  $f_{SUB}$ : Subsystem clock frequency (XT1 clock oscillation frequency)
  4. Except subsystem clock operation, temperature condition of the TYP. value is  $T_A = 25^\circ\text{C}$

## (2) Standby current

(T<sub>A</sub> = -40 to +85°C, 1.6 V ≤ V<sub>DD</sub> = V<sub>DD\_RF</sub> = AV<sub>DD\_RF</sub> ≤ 3.6 V, V<sub>SS</sub> = V<sub>SS\_RF</sub> = AV<sub>SS\_RF</sub> = 0 V)

Parameter	Symbol	Conditions		MIN.	TYP.	MAX.	Unit		
HALT current Note 1, 2	I <sub>DD2</sub>	HS (high-speed main) mode <sup>Note 7</sup>	f <sub>IH</sub> = 32 MHz <sup>Note 4</sup>	V <sub>DD</sub> = 3.0 V		0.62	1.86	mA	
			f <sub>IH</sub> = 24 MHz <sup>Note 4</sup>	V <sub>DD</sub> = 3.0 V		0.50	1.45	mA	
			f <sub>IH</sub> = 16 MHz <sup>Note 4</sup>	V <sub>DD</sub> = 3.0 V		0.44	1.11	mA	
		LS (low-speed main) mode <sup>Note 7</sup>	f <sub>IH</sub> = 8 MHz <sup>Note 4</sup>	V <sub>DD</sub> = 3.0 V		290	620	μA	
				V <sub>DD</sub> = 2.0 V		290	620	μA	
		LV (low-voltage main) mode <sup>Note 7</sup>	f <sub>IH</sub> = 4 MHz <sup>Note 4</sup>	V <sub>DD</sub> = 3.0 V		440	680	μA	
				V <sub>DD</sub> = 2.0 V		440	680	μA	
		HS (high-speed main) mode <sup>Note 7</sup>	f <sub>MX</sub> = 20 MHz <sup>Note 3</sup>	V <sub>DD</sub> = 3.0 V <sup>Note 9</sup>		0.31	1.08	mA	
						0.48	1.28	mA	
						0.21	0.63	mA	
		LS (low-speed main) mode <sup>Note 7</sup>	f <sub>MX</sub> = 10 MHz <sup>Note 3</sup>	V <sub>DD</sub> = 3.0 V <sup>Note 9</sup>		0.28	0.71	mA	
						110	360	μA	
						160	420	μA	
		Subsystem clock operation	f <sub>SUB</sub> = 32.768kHz <sup>Note 5</sup>	V <sub>DD</sub> = 3.0 V <sup>Note 9</sup>	T <sub>A</sub> = -40°C <sup>Note 9</sup>		0.28	0.61	μA
					T <sub>A</sub> = +25°C <sup>Note 9</sup>		0.47	0.80	μA
				V <sub>DD</sub> = 2.0 V <sup>Note 9</sup>	T <sub>A</sub> = +50°C <sup>Note 9</sup>		0.34	0.61	μA
T <sub>A</sub> = +70°C <sup>Note 9</sup>					0.53	0.80	μA		
STOP current <sup>Note 6, 8</sup>	I <sub>DD3</sub>	T <sub>A</sub> = -40°C			0.19	0.52	μA		
		T <sub>A</sub> = +25°C			0.25	0.52	μA		
		T <sub>A</sub> = +50°C			0.32	2.21	μA		
		T <sub>A</sub> = +70°C			0.55	3.94	μA		
		T <sub>A</sub> = +85°C			1.00	7.95	μA		

(Notes and Remarks are listed on the next page.)

- Note**
1. Current flowing into  $V_{DD}$ , including the input leakage current flowing when the level of the input pin is fixed to  $V_{DD}$  or  $V_{SS}$ . The values below the MAX. column include the peripheral operation current. However, not including the current flowing into the A/D converter, LVD circuit, I/O port, and on-chip pull-up/pull-down resistors and the current flowing during data flash rewrite.
  2. During HALT instruction execution by flash memory.
  3. When high-speed on-chip oscillator and subsystem clock are stopped.
  4. When high-speed system clock and subsystem clock are stopped.
  5. When high-speed on-chip oscillator and high-speed system clock are stopped. When setting ultra-low current consumption (AMPHS1 = 1). The current flowing into the RTC is included. However, not including the current flowing into the 12-bit interval timer and watchdog timer.
  6. Not including the current flowing into the RTC, 12-bit interval timer, and watchdog timer.
  7. Relationship between operation voltage width, operation frequency of CPU and operation mode is as below.  
 HS (high-speed main) mode:  $2.7\text{ V} \leq V_{DD} \leq 3.6\text{ V}@1\text{ MHz to }32\text{ MHz}$   
 $2.4\text{ V} \leq V_{DD} \leq 3.6\text{ V}@1\text{ MHz to }16\text{ MHz}$   
 LS (low-speed main) mode:  $1.8\text{ V} \leq V_{DD} \leq 3.6\text{ V}@1\text{ MHz to }8\text{ MHz}$   
 LV (low-voltage main) mode:  $1.6\text{ V} \leq V_{DD} \leq 3.6\text{ V}@1\text{ MHz to }4\text{ MHz}$
  8. If operation of the subsystem clock when STOP mode, same as when HALT mode of subsystem clock operation.
  9. The upper value is for square-wave input and the lower is with an oscillator connected.

- Remark**
1.  $f_{MX}$ : High-speed system clock frequency (External main system clock frequency)
  2.  $f_{IH}$ : High-speed on-chip oscillator clock frequency
  3.  $f_{SUB}$ : Subsystem clock frequency (XT1 clock oscillation frequency)
  4. Except subsystem clock operation and STOP mode, temperature condition of the TYP. value is  $T_A = 25^\circ\text{C}$

**(3) Current for each peripheral circuit**

( $T_A = -40$  to  $+85^\circ\text{C}$ ,  $1.6\text{ V} \leq V_{DD} = V_{DD\_RF} = AV_{DD\_RF} \leq 3.6\text{ V}$ ,  $V_{SS} = V_{SS\_RF} = AV_{SS\_RF} = 0\text{ V}$ )

Parameter	Symbol	Conditions		MIN.	TYP.	MAX.	Unit
Low-speed on-chip oscillator operating current	$I_{FIL}$ <sup>Note 1</sup>				0.20		$\mu\text{A}$
Current when PCLBUZ0 and EXSLK_RF are connected together and MCU supplies RF slow clock to RF	$I_{PCEX}$ <sup>Note 1</sup>				1.0		$\mu\text{A}$
RTC operating current	$I_{RTC}$ <sup>Note 1, 2, 3</sup>				0.02		$\mu\text{A}$
12-bit interval timer operating current	$I_{IT}$ <sup>Note 1, 2, 4</sup>				0.02		$\mu\text{A}$
Watchdog timer operating current	$I_{WDT}$ <sup>Note 1, 2, 5</sup>	f <sub>IL</sub> is 15 kHz			0.22		$\mu\text{A}$
A/D converter operating current	$I_{ADC}$ <sup>Note 1, 6</sup>	When conversion at maximum speed	$AV_{REFP} = V_{DD} = 3.0\text{ V}$		0.5	0.7	$\text{mA}$
A/D converter reference voltage current	$I_{ADREF}$ <sup>Note 1</sup>				75.0		$\mu\text{A}$
Thermometer sensor operating current	$I_{TMPS}$ <sup>Note 1</sup>				75.0		$\mu\text{A}$
LVD operating current	$I_{LVI}$ <sup>Note 1, 7</sup>				0.08		$\mu\text{A}$
Flash self-programming operating current	$I_{FSP}$ <sup>Note 1, 9</sup>				2.50	12.20	$\text{mA}$
BGO current	$I_{BGO}$ <sup>Note 1, 8</sup>				2.50	12.20	$\text{mA}$
SNOOZE operating current	$I_{SNOZ}$ <sup>Note 1</sup>	ADC operation	The mode is performed <sup>Note 10</sup>		0.50	0.60	$\text{mA}$
			The A/D conversion operations are performed, Low voltage mode, $AV_{REFP} = V_{DD} = 3.0\text{ V}$		1.20	1.44	$\text{mA}$
		CSI/UART operation			0.70	0.84	$\text{mA}$

**Note 1.** Current flowing to  $V_{DD}$ .

2. When high speed on-chip oscillator and high-speed system clock are stopped.
3. Current flowing only to the real-time clock (RTC) (excluding the operating current of the XT1 oscillator). The value of the current value of the RL78 microcontroller is the sum of the values of either  $I_{DD1}$  or  $I_{DD2}$ , and  $I_{RTC}$ , when the real-time clock operates in operation mode or HALT mode. Also, add the value of  $I_{FIL}$  in case of selecting low-speed on-chip oscillator.  $I_{DD2}$  subsystem clock operation includes the operational current of the real-time clock.
4. Current flowing only to the 12 bit interval timer (including the operating current of the low-speed on-chip oscillator). The current value of the MCU is the sum of  $I_{DD1}$  or  $I_{DD2}$  and  $I_{IT}$  when  $f_{CLK} = f_{SUB}$  when the watchdog timer operates in STOP mode. When using low-speed on-chip oscillator, add  $I_{FIL}$ .
5. Current flowing only to the watchdog timer (including the operating current of the low-speed on-chip oscillator). The current value of the MCU is the sum of  $I_{DD1}$ ,  $I_{DD2}$  or  $I_{DD3}$  and  $I_{WDT}$  when the watchdog timer is in operation.
6. Current flowing only to the A/D converter. The current value of MCU is the sum of  $I_{DD1}$  or  $I_{DD2}$  and  $I_{ADC}$  when the A/D converter operates in an operation mode or the HALT mode.
7. Current flowing only to the LVD circuit. The current value of MCU is the sum of  $I_{DD1}$ ,  $I_{DD2}$  or  $I_{DD3}$  and  $I_{LVI}$  when the LVD circuit is in operation.
8. Current flowing when operates rewriting to Data flash.
9. Current flowing when operates flash self-programming.
10. Shift time to the SNOOZE mode is referred User's Manual: Hardware.

(Remarks are listed on the next page.)

- Remark 1.**  $f_{IL}$ : Low-speed on-chip oscillator clock frequency  
**2.**  $f_{SUB}$ : Subsystem clock frequency  
**3.**  $f_{CLK}$ : CPU and peripheral hardware clock frequency  
**4.** Temperature condition of the TYP. value is  $T_A = 25^\circ\text{C}$

### 2.5.2 RF unit

( $T_A = -40$  to  $+85^\circ\text{C}$ ,  $1.6\text{ V} \leq V_{DD} = V_{DD\_RF} = AV_{DD\_RF} \leq 3.6\text{ V}$ ,  $V_{SS} = V_{SS\_RF} = AV_{SS\_RF} = 0\text{ V}$ )

Parameter	Symbol	Conditions		MIN.	TYP.	MAX.	Unit	
Supply current Note 1, 2	I <sub>DDRF<sub>TX</sub></sub>	Transmission peak current	Transmission output power 0 dBm	RF normal mode	-	4.3	5.7	mA
					-	7.4	9.0	mA
				RF low power mode	-	2.6	4.1	mA
					-	4.4	6.0	mA
				RF high performance mode	-	4.3	5.7	mA
					-	7.4	9.0	mA
	I <sub>DDRF<sub>RX</sub></sub>	Reception peak current		RF normal mode	-	3.5	5.0	mA
					-	6.2	7.5	mA
				RF low power mode	-	3.3	4.8	mA
					-	5.8	7.1	mA
				RF high performance mode	-	3.7	5.2	mA
					-	6.6	7.9	mA
I <sub>DDRF<sub>ST</sub></sub>	STANDBY_RF current			-	0.40	0.9	mA	
				-	0.28	0.8	mA	
I <sub>DDRF<sub>SL</sub></sub>	SLEEP_RF current			-	0.50	1.1	mA	
				-	0.36	0.8	mA	
I <sub>DDRF<sub>DS</sub></sub>	DEEP_SLEEP current		RF slow clock externally input through EXSLK_RF	-	0.14	3.6	μA	
				-	0.14	3.6	μA	
			RF slow clock from on-chip oscillator	-	1.8	6.8	μA	
				-	1.8	6.8	μA	
I <sub>DDRF<sub>PD</sub></sub>	POWER_DOWN current			-	0.10	3.0	μA	
				-	0.10	3.0	μA	
I <sub>DDRF<sub>RS</sub></sub>	RESET_RF current			-	0.10	3.0	μA	
				-	0.10	3.0	μA	
I <sub>DDRF<sub>FIL</sub></sub>	IDLE_RF current			-	0.50	1.1	mA	
				-	0.60	1.1	mA	
I <sub>DDRF<sub>SU</sub></sub>	SETUP_RF current			-	2.5	4.7	mA	
				-	3.5	5.0	mA	

**Note 1.** Total current flowing into  $V_{DD\_RF}$ , and  $AV_{DD\_RF}$ .

- 2.** For each item, the values in the upper and lower row apply respectively when the DC/DC converter embedded in the RF chip is and is not in use.



## 2.6 AC Characteristics

(T<sub>A</sub> = -40 to +85°C, 1.6 V ≤ V<sub>DD</sub> = V<sub>DD\_RF</sub> = AV<sub>DD\_RF</sub> ≤ 3.6 V, V<sub>SS</sub> = V<sub>SS\_RF</sub> = AV<sub>SS\_RF</sub> = 0 V)

Items	Symbol	Conditions		MIN.	TYP.	MAX.	Unit		
Cycle time (minimum instruction execution time)	T <sub>CY</sub>	Main system (f <sub>MAIN</sub> ) clock operation	HS (high-speed main) mode	2.7 V ≤ V <sub>DD</sub> ≤ 3.6 V	0.03125		1	μs	
				2.4 V ≤ V <sub>DD</sub> < 2.7 V	0.0625		1	μs	
			LV (low-voltage main) mode		0.25		1	μs	
			LS (low-speed main) mode		0.125		1	μs	
		Subsystem clock (f <sub>SUB</sub> ) operation		28.5	30.5	31.3	μs		
		In the self programming mode	HS (high-speed main) mode	2.7 V ≤ V <sub>DD</sub> ≤ 3.6 V	0.03125		1	μs	
				2.4 V ≤ V <sub>DD</sub> < 2.7 V	0.0625		1	μs	
			LV (low-voltage main) mode		0.25		1	μs	
LS (low-speed main) mode			0.125		1	μs			
External clock frequency	f <sub>EX</sub>	EXCLK		2.7 V ≤ V <sub>DD</sub> ≤ 3.6 V	1		20	MHz	
				2.4 V ≤ V <sub>DD</sub> < 2.7 V	1		16	MHz	
				1.8 V ≤ V <sub>DD</sub> < 2.4 V	1		8	MHz	
	f <sub>EXS</sub>	EXCLKS		32		35	kHz		
	f <sub>EXRF</sub>	EXSLK_RF	When 32.768 kHz input	±500 ppm	32.751616	32.768	32.784384	kHz	
			When 16.384 kHz input	±500 ppm	16.375808	16.384	16.392192	kHz	
External clock input high-level width, low-level width	t <sub>EXH</sub> , t <sub>EXL</sub>	EXCLK		2.7 V ≤ V <sub>DD</sub> ≤ 3.6 V	24			ns	
				2.4 V ≤ V <sub>DD</sub> < 2.7 V	30			ns	
				1.8 V ≤ V <sub>DD</sub> < 2.4 V	60			ns	
	t <sub>EXHS</sub> , t <sub>EXLS</sub>	EXCLKS		13.7			μs		
	t <sub>EXHRF</sub> , t <sub>EXLRF</sub>	EXSLK_RF	When 32.768 kHz input		0.08	15.258	32.69	μs	
			When 16.384 kHz input		0.08	8.192	16.304	μs	
Timer input high-level width, low-level width	t <sub>TIH</sub> , t <sub>TIL</sub>	TI00, TI01, TI02, TI03, TI04, TI05, TI06, TI07		1/f <sub>MCK</sub> +10			ns		
Timer output frequency	t <sub>TO</sub>	TI00, TI01, TI02, TI03, TI04, TI05, TI06, TI07	HS (high-speed main) mode	2.7 V ≤ V <sub>DD</sub> < 3.6 V			8	MHz	
				2.4 V ≤ V <sub>DD</sub> < 2.7 V			4	MHz	
		LV (low-voltage main) mode					4	MHz	
		LS (low-speed main) mode					4	MHz	
Clock/buzzer output frequency	t <sub>PLC</sub>	PCLBUZ0	HS (high-speed main) mode	2.7 V ≤ V <sub>DD</sub> < 3.6 V			8	MHz	
				2.4 V ≤ V <sub>DD</sub> < 2.7 V			4	MHz	
			LV (low-voltage main) mode					4	MHz
			LS (low-speed main) mode					4	MHz
	t <sub>PLCRF</sub>	CLKOUT_RF					16	MHz	

**Remark** f<sub>MCK</sub>: Timer array unit operation clock frequency

(Operation clock to be set by the CKSmn0, CKSmn1 bits of timer mode register mn (TMRmn).

m: Unit number (m = 0, 1), n: Channel number (n = 0 to 7))

( $T_A = -40$  to  $+85^\circ\text{C}$ ,  $1.6\text{ V} \leq V_{DD} = V_{DD\_RF} = AV_{DD\_RF} \leq 3.6\text{ V}$ ,  $V_{SS} = V_{SS\_RF} = AV_{SS\_RF} = 0\text{ V}$ ) (2/2)

Items	Symbol	Conditions	MIN.	TYP.	MAX.	Unit
Interrupt input high-level width, low-level width	$t_{INTH}$ , $t_{INTL}$	INTP0, INTP3, INTP5, INTP6	1			$\mu\text{s}$
External PA control output High-level width	$t_{PAHRF}$	TXSELH_RF	283			$\mu\text{s}$
External PA control output low-level width	$t_{PALRF}$	TXSELL_RF	283			$\mu\text{s}$
RESET low-level width	$t_{RSL}$	RESET	10			$\mu\text{s}$
RESET_RF internal pin low-level width	$t_{RSTLRF}$	RESET_RF internal pin	31			$\mu\text{s}$

**Minimum Instruction Execution Time during Main System Clock Operation**

$T_{CY}$  vs  $V_{DD}$  (HS (high-speed main) mode)

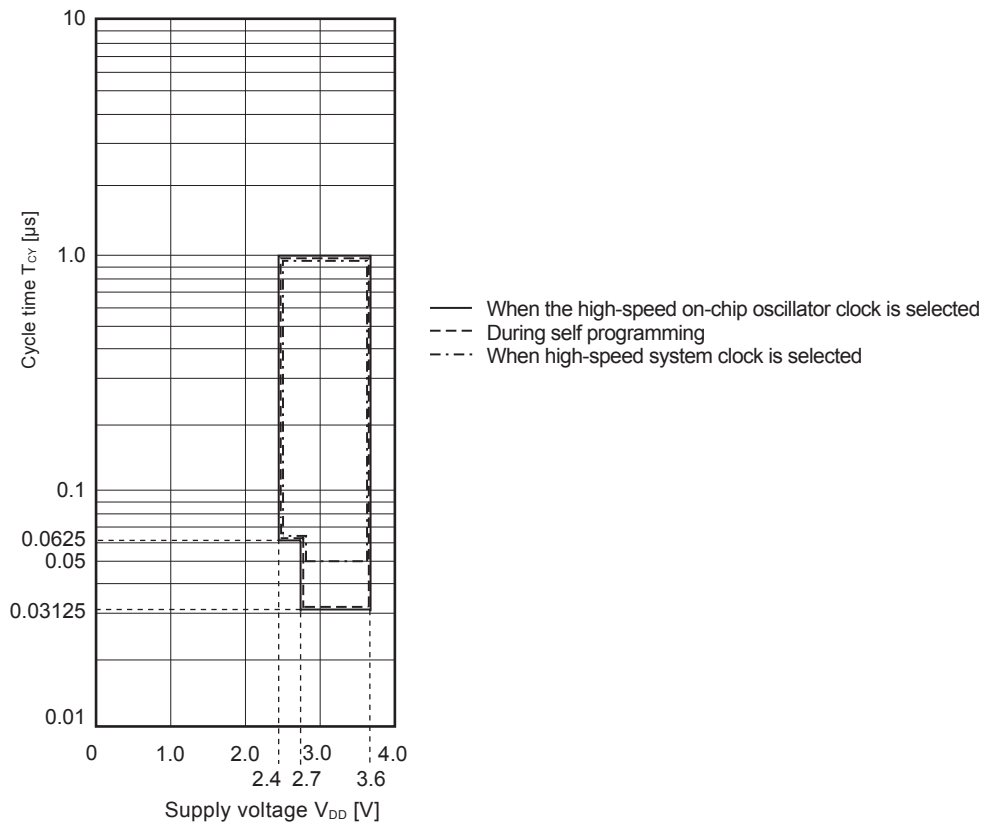

$T_{CY}$  vs  $V_{DD}$  (LS (low-speed main) mode)

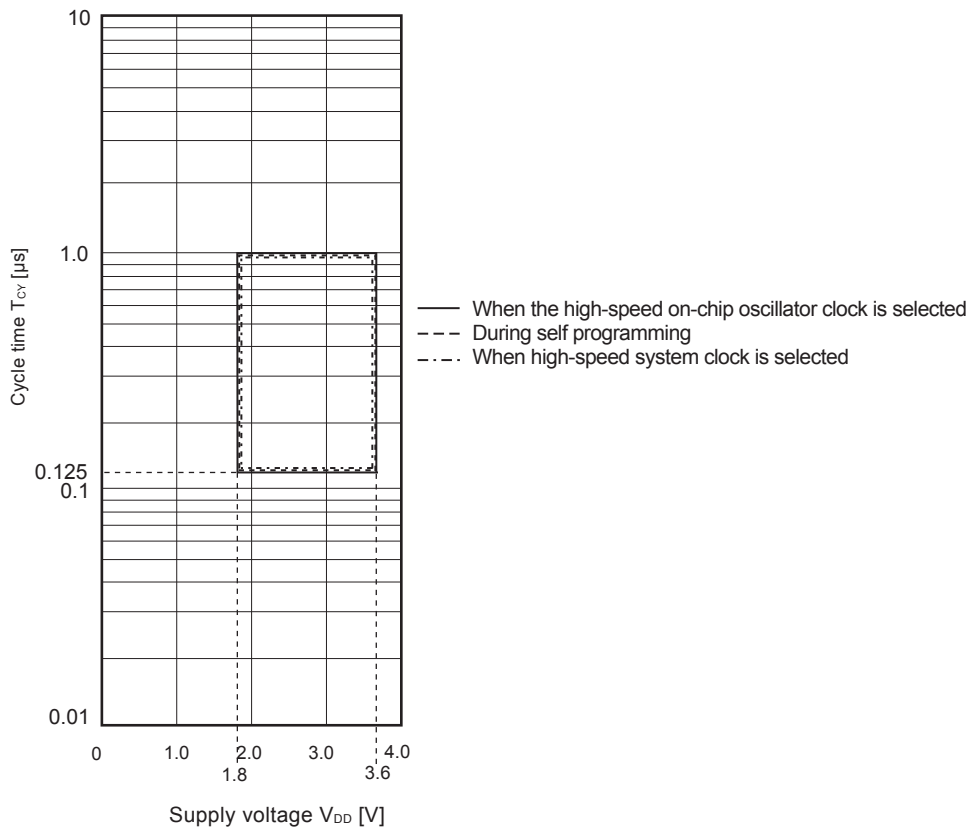

$T_{CY}$  vs  $V_{DD}$  (LV (low-voltage main) mode)

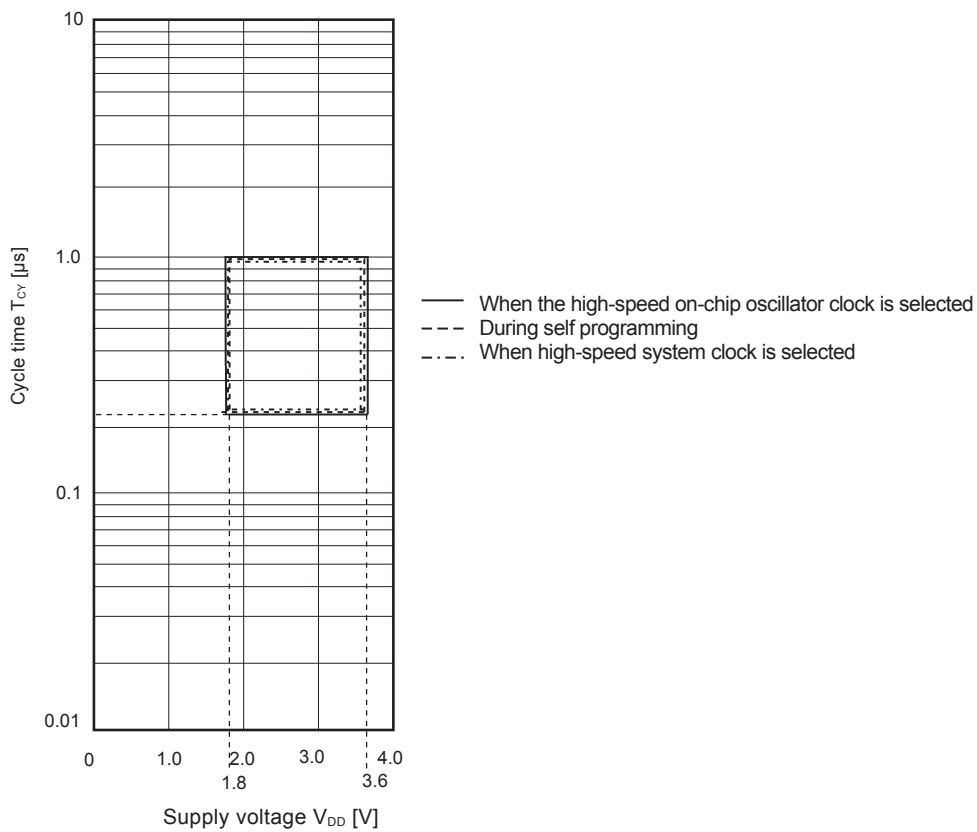

**AC Timing Test Points**

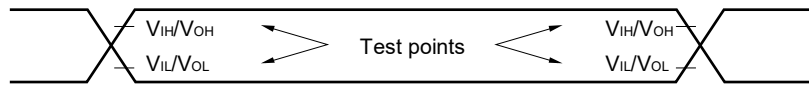

**External System Clock Timing**

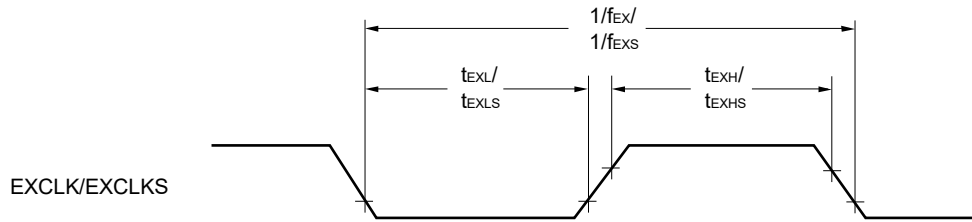

**TI/TO Timing**

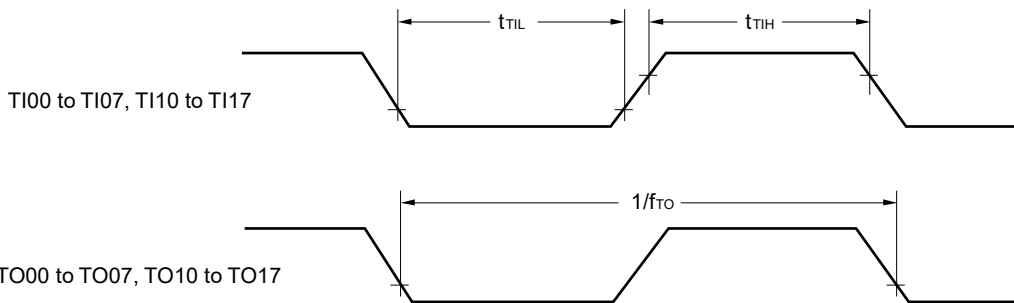

**Interrupt Request Input Timing**

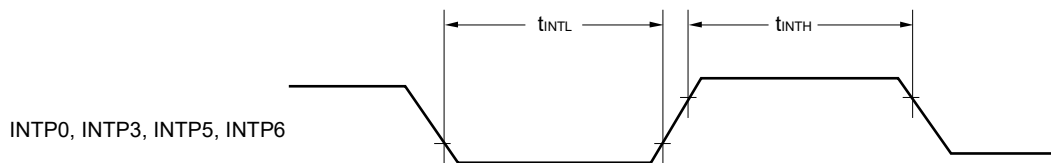

**RESET Input Timing**

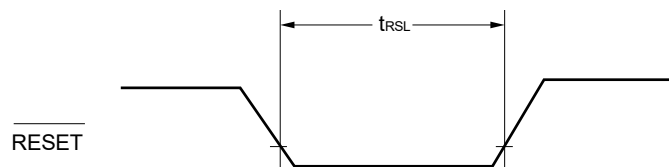

2.7 Peripheral Functions Characteristics

AC Timing Test Points

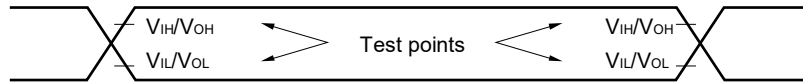

2.7.1 Serial array unit

(1) During communication at same potential (UART mode)

(TA = -40 to +85°C, 1.6 V ≤ VDD = VDD\_RF = AVDD\_RF ≤ 3.6 V, VSS = VSS\_RF = AVSS\_RF = 0 V)

Parameter	Symbol	Conditions	HS (high-speed main) Mode	LS (low-speed main) Mode	LV (low-voltage main) Mode	Unit
			MAX.	MAX.	MAX.	
Transfer rate <sup>Note 1</sup>		2.4 V ≤ VDD ≤ 3.6 V	fMCK/6	fMCK/6	fMCK/6	bps
		Theoretical value of the maximum transfer rate fMCK = fCLK <sup>Note 2</sup>	5.3	1.3	0.6	Mbps
		1.8 V ≤ VDD ≤ 3.6 V	—	fMCK/6	fMCK/6	bps
		Theoretical value of the maximum transfer rate fMCK = fCLK <sup>Note 2</sup>	—	1.3	0.6	Mbps
		1.6 V ≤ VDD ≤ 3.6 V	—	—	fMCK/6	bps
		Theoretical value of the maximum transfer rate fMCK = fCLK <sup>Note 2</sup>	—	—	0.6	Mbps

**Note 1.** Transfer rate in the SNOOZE mode is 4800 bps only.

**2.** Maximum operating frequency of CPU and peripheral hardware clock (fCLK) is following

HS (high-speed main) mode: 32 MHz (2.7 V ≤ VDD ≤ 3.6 V)

16 MHz (2.4 V ≤ VDD ≤ 3.6 V)

LS (low-speed main) mode: 8 MHz (1.8 V ≤ VDD ≤ 3.6 V)

LV (low-voltage main) mode: 4 MHz (1.6 V ≤ VDD ≤ 3.6 V)

**Caution** Select the normal input buffer for the RxDq pin and the normal output mode for the TxDq pin by using port input mode register g (PIMg) and port output mode register g (POMg).

**UART mode connection diagram (during communication at same potential)**

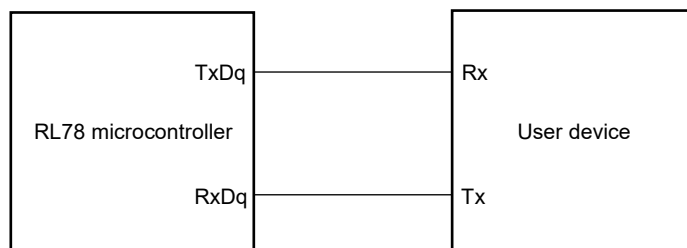

**UART mode bit width (during communication at same potential) (reference)**

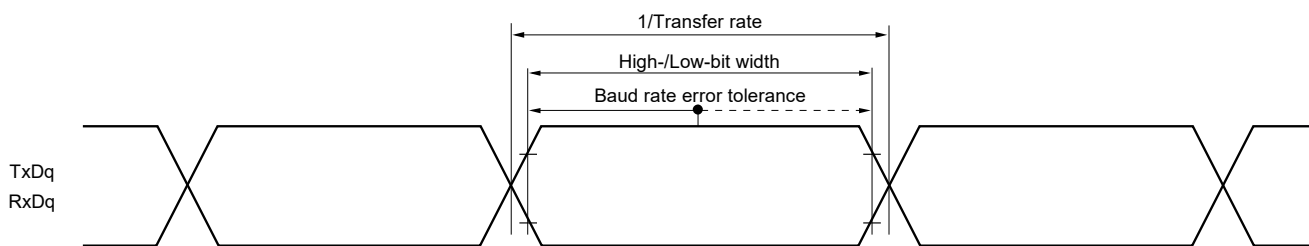

- Remark 1.** q: UART number (q = 0, 1), g: PIM and POM number (g = 0, 1)
- 2.**  $f_{MCK}$ : Serial array unit operation clock frequency  
(Operation clock to be set by the CKSmn bit of serial mode register mn (SMRmn).  
m: Unit number, n: Channel number (mn = 00, 01))

**(2) During communication at same potential (CSI mode) (master mode, SCKp... internal clock output, supporting CSI00 only)****( $T_A = -40$  to  $+85^\circ\text{C}$ ,  $2.7\text{ V} \leq V_{DD} = V_{DD\_RF} = AV_{DD\_RF} \leq 3.6\text{ V}$ ,  $V_{SS} = V_{SS\_RF} = AV_{SS\_RF} = 0\text{ V}$ )**

Parameter	Symbol	Conditions	HS (high-speed main) Mode		LS (low-speed main) Mode		LV (low-voltage main) Mode		Unit
			MIN.	MAX.	MIN.	MAX.	MIN.	MAX.	
SCKp cycle time	$t_{KCY1}$	$t_{KCY1} \geq 2/f_{CLK}$	83.3		250		500		ns
SCKp high-/low-level width	$t_{KH1}$ , $t_{KL1}$		$t_{KCY1}/2 - 10$		$t_{KCY1}/2 - 50$		$t_{KCY1}/2 - 50$		ns
Slp setup time (to SCKp $\uparrow$ ) Note 1	$t_{SIK1}$		33		110		110		ns
Slp hold time (from SCKp $\uparrow$ ) Note 1	$t_{SH1}$		10		10		10		ns
Delay time from SCKp $\downarrow$ to SOp output Note 2	$t_{KSO1}$	$C = 20\text{ pF}$ Note 3		10		10		10	ns

**Note 1.** When  $DAP_{mn} = 0$  and  $CKP_{mn} = 0$ , or  $DAP_{mn} = 1$  and  $CKP_{mn} = 1$ . The Slp time becomes “to SCKp $\downarrow$ ” when  $DAP_{mn} = 0$  and  $CKP_{mn} = 1$ , or  $DAP_{mn} = 1$  and  $CKP_{mn} = 0$ .

**2.** When  $DAP_{mn} = 0$  and  $CKP_{mn} = 0$ , or  $DAP_{mn} = 1$  and  $CKP_{mn} = 1$ . The delay time to SOp output becomes “from SCKp $\uparrow$ ” when  $DAP_{mn} = 0$  and  $CKP_{mn} = 1$ , or  $DAP_{mn} = 1$  and  $CKP_{mn} = 0$ .

**3.** C is the load capacitance of the SCKp and SOp output lines.

**Caution** Select the normal input buffer for the Slp pin and the normal output mode for the SOp pin and SCKp pin by using port input mode register g (PIMg) and port output mode register g (POMg).

**Remark 1.** This specification is valid only when CSI00's peripheral I/O redirect function is not used.

**2.** p: CSI number (p = 00), m: Unit number (m = 0), n: Channel number (n = 0),  
g: PIM and POM numbers (g = 1)

**3.**  $f_{MCK}$ : Serial array unit operation clock frequency

(Operation clock to be set by the CKSmn bit of serial mode register mn (SMRmn). m: Unit number, n: Channel number (mn = 00))

**(3) During communication at same potential (CSI mode) (Internal communication, supporting CSI21 only)****( $T_A = -40$  to  $+85^\circ\text{C}$ ,  $1.6\text{ V} \leq V_{DD} = V_{DD\_RF} = AV_{DD\_RF} \leq 3.6\text{ V}$ ,  $V_{SS} = V_{SS\_RF} = AV_{SS\_RF} = 0\text{ V}$ )**

Parameter	Symbol	Conditions	HS (high-speed main) Mode		LS (low-speed main) Mode		LV (low-voltage main) Mode		Unit	
			MIN.	MAX.	MIN.	MAX.	MIN.	MAX.		
SCKp cycle time	$t_{KCY1}$	$t_{KCY1} \geq 2/f_{CLK}$ <sup>Note</sup>	$2.4\text{ V} \leq V_{DD} \leq 3.6\text{ V}$	250		250		500		ns
			$1.8\text{ V} \leq V_{DD} \leq 3.6\text{ V}$	–		250		500		ns
			$1.6\text{ V} \leq V_{DD} \leq 3.6\text{ V}$	–		–		500		ns

**Note** Use the  $f_{CLK}$  more than 6.5 MHz and lower than 24 MHz.**Remark** This specification is for CSI21 only.



**(4) During communication at same potential (CSI mode) (master mode, SCKp... internal clock output, supporting CSI00 and CSI20)****( $T_A = -40$  to  $+85^\circ\text{C}$ ,  $1.6\text{ V} \leq V_{DD} = V_{DD\_RF} = AV_{DD\_RF} \leq 3.6\text{ V}$ ,  $V_{SS} = V_{SS\_RF} = AV_{SS\_RF} = 0\text{ V}$ )**

Parameter	Symbol	Conditions	HS (high-speed main) Mode		LS (low-speed main) Mode		LV (low-voltage main) Mode		Unit
			MIN.	MAX.	MIN.	MAX.	MIN.	MAX.	
SCKp cycle time	$t_{KCY1}$	$t_{KCY1} \geq 4/f_{CLK}$	$2.7\text{ V} \leq V_{DD} \leq 3.6\text{ V}$	125		500		1000	ns
			$2.4\text{ V} \leq V_{DD} \leq 3.6\text{ V}$	250		500		1000	ns
			$1.8\text{ V} \leq V_{DD} \leq 3.6\text{ V}$	–		500		1000	ns
			$1.6\text{ V} \leq V_{DD} \leq 3.6\text{ V}$	–		–		1000	ns
SCKp high-/low-level width	$t_{KH1}$ , $t_{KL1}$	$2.7\text{ V} \leq V_{DD} \leq 3.6\text{ V}$	$t_{KCY1}/2 - 18$		$t_{KCY1}/2 - 50$		$t_{KCY1}/2 - 50$	ns	
		$2.4\text{ V} \leq V_{DD} \leq 3.6\text{ V}$	$t_{KCY1}/2 - 38$		$t_{KCY1}/2 - 50$		$t_{KCY1}/2 - 50$	ns	
		$1.8\text{ V} \leq V_{DD} \leq 3.6\text{ V}$	–		$t_{KCY1}/2 - 50$		$t_{KCY1}/2 - 50$	ns	
		$1.6\text{ V} \leq V_{DD} \leq 3.6\text{ V}$	–		–		$t_{KCY1}/2 - 100$	ns	
Slp setup time (to SCKp $\uparrow$ ) <sup>Note 1</sup>	$t_{SIK1}$	$2.7\text{ V} \leq V_{DD} \leq 3.6\text{ V}$	44		110		110	ns	
		$2.4\text{ V} \leq V_{DD} \leq 3.6\text{ V}$	75		110		110	ns	
		$1.8\text{ V} \leq V_{DD} \leq 3.6\text{ V}$	–		110		110	ns	
		$1.6\text{ V} \leq V_{DD} \leq 3.6\text{ V}$	–		–		220	ns	
Slp hold time (from SCKp $\uparrow$ ) <sup>Note 1</sup>	$t_{SIH1}$	$2.7\text{ V} \leq V_{DD} \leq 3.6\text{ V}$	19		19		19	ns	
		$2.4\text{ V} \leq V_{DD} \leq 3.6\text{ V}$	19		19		19	ns	
		$1.8\text{ V} \leq V_{DD} \leq 3.6\text{ V}$	–		19		19	ns	
		$1.6\text{ V} \leq V_{DD} \leq 3.6\text{ V}$	–		–		19	ns	
Delay time from SCKp $\downarrow$ to SOp output <sup>Note 2</sup>	$t_{KSO1}$	C = 30 pF <sup>Note 3</sup>	$2.7\text{ V} \leq V_{DD} \leq 3.6\text{ V}$		25		25	25	ns
			$2.4\text{ V} \leq V_{DD} \leq 3.6\text{ V}$		25		25	25	ns
			$1.8\text{ V} \leq V_{DD} \leq 3.6\text{ V}$		–		25	25	ns
			$1.6\text{ V} \leq V_{DD} \leq 3.6\text{ V}$		–		–	25	ns

**Note 1.** When DAPmn = 0 and CKPmn = 0, or DAPmn = 1 and CKPmn = 1. The Slp time becomes “to SCKp $\downarrow$ ” when DAPmn = 0 and CKPmn = 1, or DAPmn = 1 and CKPmn = 0.

**2.** When DAPmn = 0 and CKPmn = 0, or DAPmn = 1 and CKPmn = 1. The delay time to SOp output becomes “from SCKp $\uparrow$ ” when DAPmn = 0 and CKPmn = 1, or DAPmn = 1 and CKPmn = 0.

**3.** C is the load capacitance of the SCKp and SOp output lines.

**Caution** Select the normal input buffer for the Slp pin and the normal output mode for the SOp pin and SCKp pin by using port input mode register g (PIMg) and port output mode register g (POMg).

**Remark 1.** p: CSI number (p = 00, 10), m: Unit number (m = 0, 1), n: Channel number (n = 0, 1),  
g: PIM and POM numbers (g = 0, 1)

**2.** f<sub>MCK</sub>: Serial array unit operation clock frequency

(Operation clock to be set by the CKS<sub>mn</sub> bit of serial mode register mn (SMR<sub>mn</sub>). m: Unit number, n: Channel number (mn = 00, 02, 11))

## (5) During communication at same potential (CSI mode) (slave mode, SCKp... external clock input, supporting CSI00 and CSI20)

(T<sub>A</sub> = -40 to +85°C, 1.6 V ≤ V<sub>DD</sub> = V<sub>DD\_RF</sub> = AV<sub>DD\_RF</sub> ≤ 3.6 V, V<sub>SS</sub> = V<sub>SS\_RF</sub> = AV<sub>SS\_RF</sub> = 0 V)

Parameter	Symbol	Conditions		HS (high-speed main) Mode		LS (low-speed main) Mode		LV (low-voltage main) Mode		Unit	
				MIN.	MAX.	MIN.	MAX.	MIN.	MAX.		
SCKp cycle time Note 4	t <sub>KCY2</sub>	2.7 V ≤ V <sub>DD</sub> ≤ 3.6 V	f <sub>MCK</sub> > 16 MHz	8/f <sub>MCK</sub>		–		–		ns	
			f <sub>MCK</sub> ≤ 16 MHz	6/f <sub>MCK</sub>		6/f <sub>MCK</sub>		6/f <sub>MCK</sub>			
		2.4 V ≤ V <sub>DD</sub> ≤ 3.6 V			6/f <sub>MCK</sub> and 500		6/f <sub>MCK</sub> and 500		6/f <sub>MCK</sub> and 500		ns
		1.8 V ≤ V <sub>DD</sub> ≤ 3.6 V			–		6/f <sub>MCK</sub> and 750		6/f <sub>MCK</sub> and 750		ns
1.6 V ≤ V <sub>DD</sub> ≤ 3.6 V			–		–		6/f <sub>MCK</sub> and 1500		ns		
SCKp high-/low-level width	t <sub>KH2</sub> , t <sub>KL2</sub>	2.7 V ≤ V <sub>DD</sub> ≤ 3.6 V		t <sub>KCY2</sub> /2–8		t <sub>KCY2</sub> /2–8		t <sub>KCY2</sub> /2–8		ns	
		2.4 V ≤ V <sub>DD</sub> ≤ 3.6 V		t <sub>KCY2</sub> /2–18		t <sub>KCY2</sub> /2–18		t <sub>KCY2</sub> /2–18		ns	
		1.8 V ≤ V <sub>DD</sub> ≤ 3.6 V		–		t <sub>KCY2</sub> /2–18		t <sub>KCY2</sub> /2–18		ns	
		1.6 V ≤ V <sub>DD</sub> ≤ 3.6 V		–		–		t <sub>KCY2</sub> /2–66		ns	
Slp setup time (to SCKp↑) Note 1	t <sub>SIK2</sub>	2.7 V ≤ V <sub>DD</sub> ≤ 3.6 V		1/f <sub>MCK</sub> +20		1/f <sub>MCK</sub> +30		1/f <sub>MCK</sub> +30		ns	
		2.4 V ≤ V <sub>DD</sub> ≤ 3.6 V		1/f <sub>MCK</sub> +30		1/f <sub>MCK</sub> +30		1/f <sub>MCK</sub> +30		ns	
		1.8 V ≤ V <sub>DD</sub> ≤ 3.6 V		–		1/f <sub>MCK</sub> +30		1/f <sub>MCK</sub> +30		ns	
		1.6 V ≤ V <sub>DD</sub> ≤ 3.6 V		–		–		1/f <sub>MCK</sub> +40		ns	
Slp hold time (from SCKp↑) Note 1	t <sub>KS12</sub>	2.4 V ≤ V <sub>DD</sub> ≤ 3.6 V		1/f <sub>MCK</sub> +31		1/f <sub>MCK</sub> +31		1/f <sub>MCK</sub> +31		ns	
		1.8 V ≤ V <sub>DD</sub> ≤ 3.6 V		–		1/f <sub>MCK</sub> +31		1/f <sub>MCK</sub> +31		ns	
		1.6 V ≤ V <sub>DD</sub> ≤ 3.6 V		–		–		1/f <sub>MCK</sub> +250		ns	
Delay time from SCKp↓ to SOP output Note 2	t <sub>KSO2</sub>	C = 30 pF Note 3	2.7 V ≤ V <sub>DD</sub> ≤ 3.6 V	2/f <sub>MCK</sub> +44		2/f <sub>MCK</sub> +110		2/f <sub>MCK</sub> +110		ns	
			2.4 V ≤ V <sub>DD</sub> ≤ 3.6 V	2/f <sub>MCK</sub> +75		2/f <sub>MCK</sub> +110		2/f <sub>MCK</sub> +110		ns	
			1.8 V ≤ V <sub>DD</sub> ≤ 3.6 V	–		2/f <sub>MCK</sub> +110		2/f <sub>MCK</sub> +110		ns	
			1.6 V ≤ V <sub>DD</sub> ≤ 3.6 V	–		–		2/f <sub>MCK</sub> +220		ns	

**Note 1.** When DAPmn = 0 and CKPmn = 0, or DAPmn = 1 and CKPmn = 1. The Slp time becomes “to SCKp↓” when DAPmn = 0 and CKPmn = 1, or DAPmn = 1 and CKPmn = 0.

**2.** When DAPmn = 0 and CKPmn = 0, or DAPmn = 1 and CKPmn = 1. The delay time to SOP output becomes “from SCKp↑” when DAPmn = 0 and CKPmn = 1, or DAPmn = 1 and CKPmn = 0.

**3.** C is the load capacitance of the SOP output lines.

**4.** Transfer rate in the SNOOZE mode: MAX. 1 Mbps

(Caution and Remarks are listed on the next page.)

**Caution** Select the normal input buffer for the SIp pin and SCKp pin and the normal output mode for the SOp pin by using port input mode register g (PIMg) and port output mode register g (POMg).

- Remark**
1. p: CSI number (p = 00, 20), m: Unit number (m = 0, 1),  
n: Channel number (n = 0), g: PIM and POM numbers (g = 1)
  2.  $f_{MCK}$ : Serial array unit operation clock frequency  
(Operation clock to be set by the CKSmn bit of serial mode register mn (SMRmn).  
m: Unit number, n: Channel number (mn = 00, 10))

**CSI mode connection diagram (during communication at same potential)**

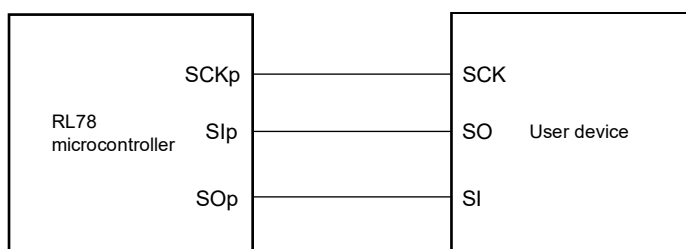

**CSI mode serial transfer timing (during communication at same potential)**  
**(When DAPmn = 0 and CKPmn = 0, or DAPmn = 1 and CKPmn = 1.)**

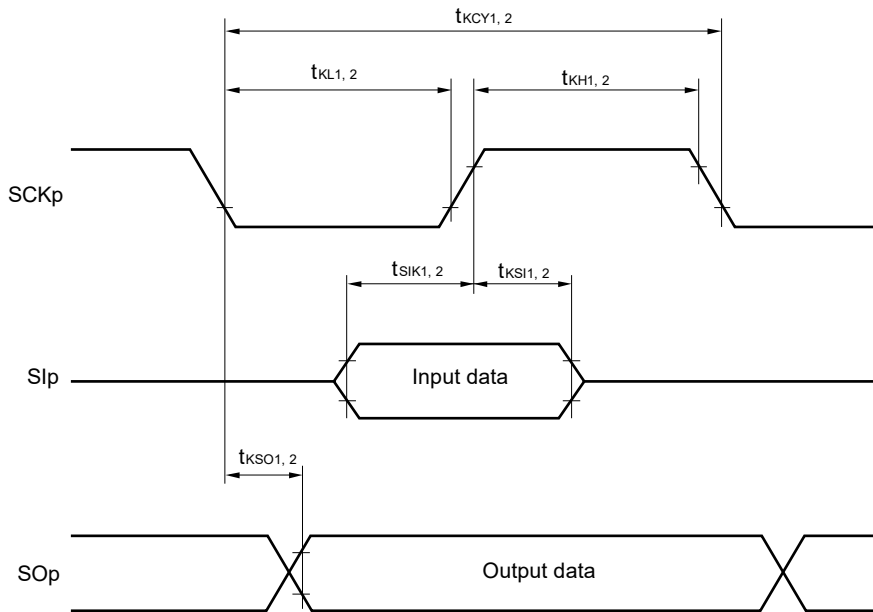

**CSI mode serial transfer timing (during communication at same potential)**  
**(When DAPmn = 0 and CKPmn = 1, or DAPmn = 1 and CKPmn = 0.)**

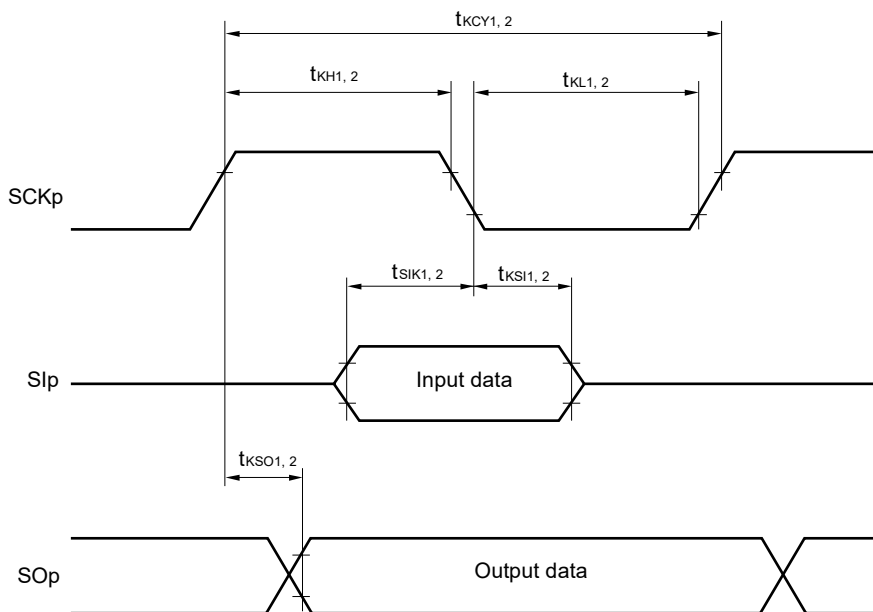

- Remark 1.** p: CSI number (p = 00, 10, 21)
- 2.** m: Unit number, n: Channel number (mn = 00, 02, 11)

(6) During communication at same potential (simplified I<sup>2</sup>C mode) (1/2)(T<sub>A</sub> = -40 to +85°C, 1.6 V ≤ V<sub>DD</sub> = V<sub>DD\_RF</sub> = AV<sub>DD\_RF</sub> ≤ 3.6 V, V<sub>SS</sub> = V<sub>SS\_RF</sub> = AV<sub>SS\_RF</sub> = 0 V)

Parameter	Symbol	Conditions	HS (high-speed main) Mode		LS (low-speed main) Mode		LV (low-voltage main) Mode		Unit
			MIN.	MAX.	MIN.	MAX.	MIN.	MAX.	
SCLr clock frequency	f <sub>SCL</sub>	2.7 V ≤ V <sub>DD</sub> ≤ 3.6 V, C <sub>b</sub> = 50 pF, R <sub>b</sub> = 2.7 kΩ		1000 Note 1		400 Note 1		400 Note 1	kHz
		2.4 V ≤ V <sub>DD</sub> ≤ 3.6 V, C <sub>b</sub> = 100 pF, R <sub>b</sub> = 3 kΩ		400 Note 1		400 Note 1		400 Note 1	kHz
		1.8 V ≤ V <sub>DD</sub> < 3.6 V, C <sub>b</sub> = 100 pF, R <sub>b</sub> = 3 kΩ		–		400 Note 1		400 Note 1	kHz
		2.4 V ≤ V <sub>DD</sub> < 2.7 V, C <sub>b</sub> = 100 pF, R <sub>b</sub> = 5 kΩ		300 Note 1		300 Note 1		300 Note 1	kHz
		1.8 V ≤ V <sub>DD</sub> < 2.7 V, C <sub>b</sub> = 100 pF, R <sub>b</sub> = 5 kΩ		–		300 Note 1		300 Note 1	kHz
		1.6 V ≤ V <sub>DD</sub> < 1.8 V, C <sub>b</sub> = 100 pF, R <sub>b</sub> = 5 kΩ		–		–		250 Note 1	kHz
Hold time when SCLr = "L"	t <sub>LOW</sub>	2.7 V ≤ V <sub>DD</sub> ≤ 3.6 V, C <sub>b</sub> = 50 pF, R <sub>b</sub> = 2.7 kΩ	475		1150		1150		ns
		2.4 V ≤ V <sub>DD</sub> ≤ 3.6 V, C <sub>b</sub> = 100 pF, R <sub>b</sub> = 3 kΩ	1150		1150		1150		ns
		1.8 V ≤ V <sub>DD</sub> < 3.6 V, C <sub>b</sub> = 100 pF, R <sub>b</sub> = 3 kΩ	–		1150		1150		ns
		2.4 V ≤ V <sub>DD</sub> < 2.7 V, C <sub>b</sub> = 100 pF, R <sub>b</sub> = 5 kΩ	1550		1550		1550		ns
		1.8 V ≤ V <sub>DD</sub> < 2.7 V, C <sub>b</sub> = 100 pF, R <sub>b</sub> = 5 kΩ	–		1550		1550		ns
		1.6 V ≤ V <sub>DD</sub> < 1.8 V, C <sub>b</sub> = 100 pF, R <sub>b</sub> = 5 kΩ	–		–		1850		ns
Hold time when SCLr = "H"	t <sub>HIGH</sub>	2.7 V ≤ V <sub>DD</sub> ≤ 3.6 V, C <sub>b</sub> = 50 pF, R <sub>b</sub> = 2.7 kΩ	475		1150		1150		ns
		2.4 V ≤ V <sub>DD</sub> ≤ 3.6 V, C <sub>b</sub> = 100 pF, R <sub>b</sub> = 3 kΩ	1150		1150		1150		ns
		1.8 V ≤ V <sub>DD</sub> < 3.6 V, C <sub>b</sub> = 100 pF, R <sub>b</sub> = 3 kΩ	–		1150		1150		ns
		2.4 V ≤ V <sub>DD</sub> < 2.7 V, C <sub>b</sub> = 100 pF, R <sub>b</sub> = 5 kΩ	1550		1550		1550		ns
		1.8 V ≤ V <sub>DD</sub> < 2.7 V, C <sub>b</sub> = 100 pF, R <sub>b</sub> = 5 kΩ	–		1550		1550		ns
		1.6 V ≤ V <sub>DD</sub> < 1.8 V, C <sub>b</sub> = 100 pF, R <sub>b</sub> = 5 kΩ	–		–		1850		ns

(Notes and Caution are listed on the next page, and Remarks are listed on the page after the next page.)

(6) During communication at same potential (simplified I<sup>2</sup>C mode) (2/2)(T<sub>A</sub> = -40 to +85°C, 1.6 V ≤ V<sub>DD</sub> = V<sub>DD\_RF</sub> = AV<sub>DD\_RF</sub> ≤ 3.6 V, V<sub>SS</sub> = V<sub>SS\_RF</sub> = AV<sub>SS\_RF</sub> = 0 V)

Parameter	Symbol	Conditions	HS (high-speed main) Mode		LS (low-speed main) Mode		LV (low-voltage main) Mode		Unit
			MIN.	MAX.	MIN.	MAX.	MIN.	MAX.	
Data setup time (reception)	t <sub>SU:DAT</sub>	2.7 V ≤ V <sub>DD</sub> ≤ 3.6 V, C <sub>b</sub> = 50 pF, R <sub>b</sub> = 2.7 kΩ	1/f <sub>MCK</sub> + 85 Note2		1/f <sub>MCK</sub> + 145 Note2		1/f <sub>MCK</sub> + 145 Note2		ns
		2.4 V ≤ V <sub>DD</sub> ≤ 3.6 V, C <sub>b</sub> = 100 pF, R <sub>b</sub> = 3 kΩ	1/f <sub>MCK</sub> + 145 Note2		1/f <sub>MCK</sub> + 145 Note2		1/f <sub>MCK</sub> + 145 Note2		ns
		1.8 V ≤ V <sub>DD</sub> < 3.6 V, C <sub>b</sub> = 100 pF, R <sub>b</sub> = 3 kΩ	–		1/f <sub>MCK</sub> + 145 Note2		1/f <sub>MCK</sub> + 145 Note2		ns
		2.4 V ≤ V <sub>DD</sub> < 2.7 V, C <sub>b</sub> = 100 pF, R <sub>b</sub> = 5 kΩ	1/f <sub>MCK</sub> + 230 Note2		1/f <sub>MCK</sub> + 230 Note2		1/f <sub>MCK</sub> + 230 Note2		ns
		1.8 V ≤ V <sub>DD</sub> < 2.7 V, C <sub>b</sub> = 100 pF, R <sub>b</sub> = 5 kΩ	–		1/f <sub>MCK</sub> + 230 Note2		1/f <sub>MCK</sub> + 230 Note2		ns
		1.6 V ≤ V <sub>DD</sub> < 1.8 V, C <sub>b</sub> = 100 pF, R <sub>b</sub> = 5 kΩ	–		–		1/f <sub>MCK</sub> + 290 Note2		ns
Data hold time (transmission)	t <sub>HD:DAT</sub>	2.7 V ≤ V <sub>DD</sub> ≤ 3.6 V, C <sub>b</sub> = 50 pF, R <sub>b</sub> = 2.7 kΩ	0	305	0	305	0	305	ns
		2.4 V ≤ V <sub>DD</sub> ≤ 3.6 V, C <sub>b</sub> = 100 pF, R <sub>b</sub> = 3 kΩ	0	355	0	355	0	355	ns
		1.8 V ≤ V <sub>DD</sub> < 3.6 V, C <sub>b</sub> = 100 pF, R <sub>b</sub> = 3 kΩ	–	–	0	355	0	355	ns
		2.4 V ≤ V <sub>DD</sub> < 2.7 V, C <sub>b</sub> = 100 pF, R <sub>b</sub> = 5 kΩ	0	405	0	405	0	405	ns
		1.8 V ≤ V <sub>DD</sub> < 2.7 V, C <sub>b</sub> = 100 pF, R <sub>b</sub> = 5 kΩ	–	–	0	405	0	405	ns
		1.6 V ≤ V <sub>DD</sub> < 1.8 V, C <sub>b</sub> = 100 pF, R <sub>b</sub> = 5 kΩ	–	–	–	–	0	405	ns
		1.6 V ≤ V <sub>DD</sub> < 1.8 V, C <sub>b</sub> = 100 pF, R <sub>b</sub> = 5 kΩ	–	–	–	–	0	405	ns

**Note 1.** The value must also be f<sub>MCK</sub>/4 or lower.**Note 2.** Set the f<sub>MCK</sub> value to keep the hold time of SCLr = "L" and SCLr = "H".

**Caution** Select the normal input buffer and the N-ch open drain output (V<sub>DD</sub> tolerance) mode for the SDAr pin and the normal output mode for the SCLr pin by using port input mode register g (PIMg) and port output mode register h (POMh).

(Remarks are listed on the next page.)

**Simplified I<sup>2</sup>C mode connection diagram (during communication at same potential)**

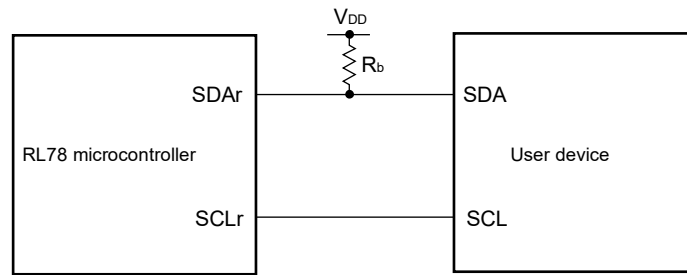

**Simplified I<sup>2</sup>C mode serial transfer timing (during communication at same potential)**

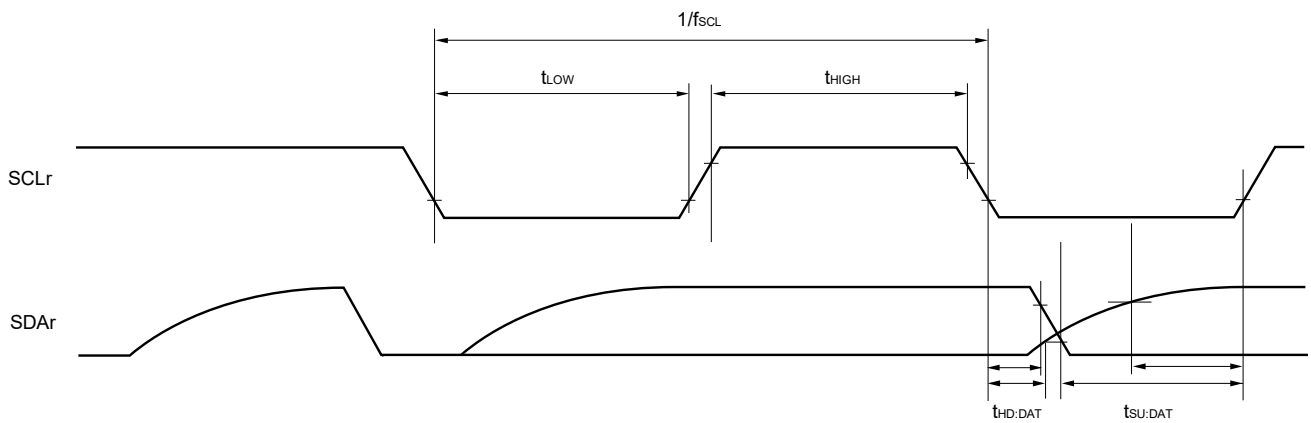

- Remark 1.**  $R_b[\Omega]$ :Communication line (SDAr) pull-up resistance,  $C_b[F]$ : Communication line (SDAr, SCLr) load capacitance
- 2.** r: IIC number (r = 00, 20), g: PIM number (g = 1), h: POM number (h = 1)
- 3.**  $f_{MCK}$ : Serial array unit operation clock frequency  
 (Operation clockw to be set by the CKSmn bit of serial mode register mn (SMRmn). m: Unit number (m = 0, 1), n: Channel number (n = 0), mn = 00, 02)

(7) Communication at different potential (1.8 V, 2.5 V) (UART mode)

( $T_A = -40$  to  $+85^\circ\text{C}$ ,  $2.4\text{ V} \leq V_{DD} = V_{DD\_RF} = AV_{DD\_RF} \leq 3.6\text{ V}$ ,  $V_{SS} = V_{SS\_RF} = AV_{SS\_RF} = 0\text{ V}$ )

Parameter	Symbol	Conditions	HS (high-speed main) Mode	LS (low-speed main) Mode	LV (low-voltage main) Mode	Unit		
			MAX.	MAX.	MAX.			
Transfer rate		Reception	$2.7\text{ V} \leq V_{DD} \leq 3.6\text{ V}$ , $2.3\text{ V} \leq V_b \leq 2.7\text{ V}$	$f_{MCK}/6$ <sup>Note 1</sup>	$f_{MCK}/6$ <sup>Note 1</sup>	$f_{MCK}/6$ <sup>Note 1</sup>	bps	
			Theoretical value of the maximum transfer rate $f_{MCK} = f_{CLK}$ <sup>Note 3</sup>	5.3	1.3	0.6	Mbps	
			$2.4\text{ V} \leq V_{DD} \leq 3.3\text{ V}$ , $1.6\text{ V} \leq V_b \leq 2.0\text{ V}$	$f_{MCK}/6$ <sup>Note 1</sup>	$f_{MCK}/6$ <sup>Note 1</sup>	$f_{MCK}/6$ <sup>Note 1</sup>	bps	
		Transmission	$2.7\text{ V} \leq V_{DD} \leq 3.6\text{ V}$ , $2.3\text{ V} \leq V_b \leq 2.7\text{ V}$	<b>Note 4</b>	<b>Note 4</b>	<b>Note 4</b>	bps	
			Theoretical value of the maximum transfer rate $C_b = 50\text{ pF}$ , $R_b = 2.7\text{ k}\Omega$ , $V_b = 2.3\text{ V}$	1.2 <sup>Note 5</sup>	1.2 <sup>Note 5</sup>	1.2 <sup>Note 5</sup>	Mbps	
			$2.4\text{ V} \leq V_{DD} < 3.3\text{ V}$ , $1.6\text{ V} \leq V_b \leq 2.0\text{ V}$	<b>Note 2, 6</b>	<b>Note 2, 6</b>	<b>Note 2, 6</b>	bps	
			Theoretical value of the maximum transfer rate $C_b = 50\text{ pF}$ , $R_b = 5.5\text{ k}\Omega$ , $V_b = 1.6\text{ V}$	0.43	0.43	0.43	Mbps	
			$1.8\text{ V} \leq V_{DD} < 3.3\text{ V}$ , $1.6\text{ V} \leq V_b \leq 2.0\text{ V}$	–	<b>Note 2, 6</b>	<b>Note 2, 6</b>	bps	
			Theoretical value of the maximum transfer rate $C_b = 50\text{ pF}$ , $R_b = 5.5\text{ k}\Omega$ , $V_b = 1.6\text{ V}$	–	0.43 <sup>Note 7</sup>	0.43 <sup>Note 7</sup>	Mbps	

- Note 1.** Transfer rate in the SNOOZE mode is 4800 bps only.
- 2.** Use it with  $V_{DD} \geq V_b$ .
- 3.** Maximum operating frequency of CPU and peripheral hardware clock ( $f_{CLK}$ ) is following  
 HS (high-speed main) mode: 32 MHz ( $2.7\text{ V} \leq V_{DD} \leq 3.6\text{ V}$ )  
 16 MHz ( $2.4\text{ V} \leq V_{DD} \leq 3.6\text{ V}$ )  
 LS (low-speed main) mode: 8 MHz ( $1.8\text{ V} \leq V_{DD} \leq 3.6\text{ V}$ )  
 LV (low-voltage main) mode: 4 MHz ( $1.8\text{ V} \leq V_{DD} \leq 3.6\text{ V}$ )
- 4.** The smaller maximum transfer rate derived by using  $f_{MCK}/6$  or the following expression is the valid maximum transfer rate.  
 Expression for calculating the transfer rate when  $2.7\text{ V} \leq V_{DD} \leq 3.6\text{ V}$  and  $2.3\text{ V} \leq V_b \leq 2.7\text{ V}$   
 Maximum transfer rate =  $1/(-C_b \times R_b \times \ln(1 - 2.0/V_b)) \times 3$  [bps]  
 Baud rate error (theoretical value) =  
 $(1/\text{transfer rate} \times 2 - \{-C_b \times R_b \times \ln(1 - 2.0/V_b)\}) / (1/\text{transfer rate}) \times \text{number of transferred bits}$   
 \* This value is the theoretical value of the relative difference between the transmission and reception sides.
- 5.** This value as an example is calculated when the conditions described in the “Conditions” column are met.  
 Refer to Note 4 above to calculate the maximum transfer rate under conditions of the customer.
- 6.** The smaller maximum transfer rate derived by using  $f_{MCK}/6$  or the following expression is the valid maximum transfer rate.  
 Expression for calculating the transfer rate when  $1.8\text{ V} \leq V_{DD} < 3.3\text{ V}$  and  $1.6\text{ V} \leq V_b \leq 2.0\text{ V}$



Maximum transfer rate =  $1 / \{-C_b \times R_b \times \ln(1 - 1.5/V_b)\} \times 3$  [bps]

Baud rate error (theoretical value) =

$(1 / \text{transfer rate} \times 2 - \{-C_b \times R_b \times \ln(1 - 1.5/V_b)\}) / (1 / \text{transfer rate}) \times \text{number of transferred bits}$

**Note 7.** This value as an example is calculated when the conditions described in the “Conditions” column are met. Refer to Note 6 above to calculate the maximum transfer rate under conditions of the customer.

**Caution** Select the TTL input buffer for the RxDq pin and the N-ch open drain output ( $V_{DD}$  tolerance) mode for the TxDq pin by using port input mode register g (PIMg) and port output mode register g (POMg). For  $V_{IH}$  and  $V_{IL}$ , see the DC characteristics with TTL input buffer selected.

- Remark 1.**  $R_b[\Omega]$ : Communication line (TxDq) pull-up resistance,  
 $C_b[F]$ : Communication line (TxDq) load capacitance,  $V_b[V]$ : Communication line voltage
2. q: UART number (q = 0, 1), g: PIM and POM numbers (g = 0, 1)
  3.  $f_{MCK}$ : Serial array unit operation clock frequency  
 (Operation clock to be set by the CKSmn bit of serial mode register mn (SMRmn).  
 m: Unit number, n: Channel number (mn = 00 to 03))

**UART mode connection diagram (during communication at different potential)**

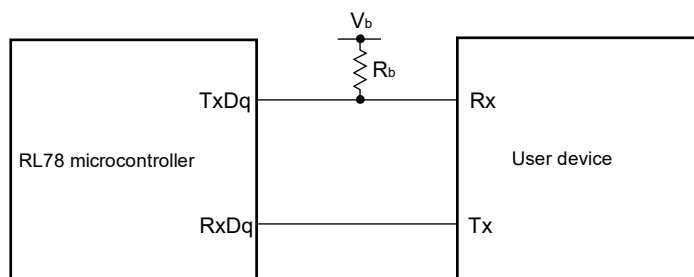

**UART mode bit width (during communication at different potential) (reference)**

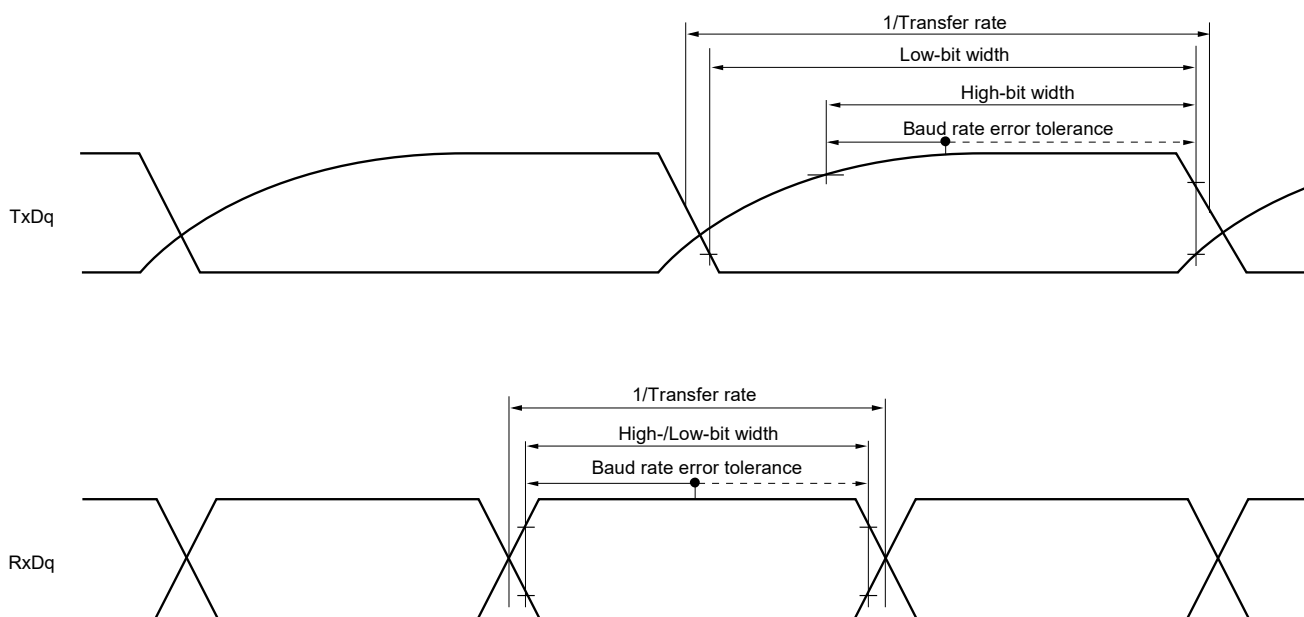

- Remark 1.**  $R_b[\Omega]$ : Communication line (TxDq) pull-up resistance,  $V_b[V]$ : Communication line voltage
2. q: UART number (q = 0, 1), g: PIM and POM number (g = 0, 1)

**(8) Communication at different potential (2.5 V) (CSI mode) (master mode: SCKp... internal clock output, supporting CSI00 only)****( $T_A = -40$  to  $+85^\circ\text{C}$ ,  $2.7\text{ V} \leq V_{DD} = V_{DD\_RF} = AV_{DD\_RF} \leq 3.6\text{ V}$ ,  $V_{SS} = V_{SS\_RF} = AV_{SS\_RF} = 0\text{ V}$ )**

Parameter	Symbol	Conditions	HS (high-speed main) Mode		LS (low-speed main) Mode		LV (low-voltage main) Mode		Unit
			MIN.	MAX.	MIN.	MAX.	MIN.	MAX.	
SCKp cycle time	$t_{KCY1}$	$t_{KCY1} \geq 2/f_{CLK}$ $2.7\text{ V} \leq V_{DD} \leq 3.6\text{ V}$ $2.3\text{ V} \leq V_b \leq 2.7\text{ V}$ $C_b = 20\text{ pF}$ , $R_b = 2.7\text{ k}\Omega$	300		1150		1150		ns
SCKp high-level width	$t_{KH1}$	$2.7\text{ V} \leq V_{DD} \leq 3.6\text{ V}$ $2.3\text{ V} \leq V_b \leq 2.7\text{ V}$ $C_b = 20\text{ pF}$ , $R_b = 2.7\text{ k}\Omega$	$t_{KCY1}/2 - 120$		$t_{KCY1}/2 - 120$		$t_{KCY1}/2 - 120$		ns
SCKp low-level width	$t_{KL1}$	$2.7\text{ V} \leq V_{DD} \leq 3.6\text{ V}$ $2.3\text{ V} \leq V_b \leq 2.7\text{ V}$ $C_b = 20\text{ pF}$ , $R_b = 2.7\text{ k}\Omega$	$t_{KCY1}/2 - 10$		$t_{KCY1}/2 - 50$		$t_{KCY1}/2 - 50$		ns
Slp setup time (to SCKp $\uparrow$ ) <sup>Note 1</sup>	$t_{SIK1}$	$2.7\text{ V} \leq V_{DD} \leq 3.6\text{ V}$ $2.3\text{ V} \leq V_b \leq 2.7\text{ V}$ $C_b = 20\text{ pF}$ , $R_b = 2.7\text{ k}\Omega$	121		479		479		ns
Slp hold time (from SCKp $\uparrow$ ) <sup>Note 1</sup>	$t_{KSI1}$	$2.7\text{ V} \leq V_{DD} \leq 3.6\text{ V}$ $2.3\text{ V} \leq V_b \leq 2.7\text{ V}$ $C_b = 20\text{ pF}$ , $R_b = 2.7\text{ k}\Omega$	10		10		10		ns
Delay time from SCKp $\downarrow$ to SOp output <sup>Note 1</sup>	$t_{KSO1}$	$2.7\text{ V} \leq V_{DD} \leq 3.6\text{ V}$ $2.3\text{ V} \leq V_b \leq 2.7\text{ V}$ $C_b = 20\text{ pF}$ , $R_b = 2.7\text{ k}\Omega$		130		130		130	ns
Slp setup time (to SCKp $\downarrow$ ) <sup>Note 2</sup>	$t_{SIK1}$	$2.7\text{ V} \leq V_{DD} \leq 3.6\text{ V}$ $2.3\text{ V} \leq V_b \leq 2.7\text{ V}$ $C_b = 20\text{ pF}$ , $R_b = 2.7\text{ k}\Omega$	33		110		110		ns
Slp hold time (from SCKp $\downarrow$ ) <sup>Note 2</sup>	$t_{KSI1}$	$2.7\text{ V} \leq V_{DD} \leq 3.6\text{ V}$ $2.3\text{ V} \leq V_b \leq 2.7\text{ V}$ $C_b = 20\text{ pF}$ , $R_b = 2.7\text{ k}\Omega$	10		10		10		ns
Delay time from SCKp $\uparrow$ to SOp output <sup>Note 2</sup>	$t_{KSO1}$	$2.7\text{ V} \leq V_{DD} \leq 3.6\text{ V}$ $2.3\text{ V} \leq V_b \leq 2.7\text{ V}$ $C_b = 20\text{ pF}$ , $R_b = 2.7\text{ k}\Omega$		10		10		10	ns

**Note 1.** When DAPmn = 0 and CKPmn = 0, or DAPmn = 1 and CKPmn = 1.**2.** When DAPmn = 0 and CKPmn = 1, or DAPmn = 1 and CKPmn = 0.

**Caution** Select the TTL input buffer for the Slp pin and the N-ch open drain output ( $V_{DD}$  tolerance) mode for the SOp pin and SCKp pin by using port input mode register g (PIMg) and port output mode register g (POMg). For  $V_{IH}$  and  $V_{IL}$ , see the DC characteristics with TTL input buffer selected.

**Remark 1.**  $R_b[\Omega]$ : Communication line (SCKp, SOp) pull-up resistance,  $C_b[\text{F}]$ : Communication line (SCKp, SOp) load capacitance,  $V_b[\text{V}]$ : Communication line voltage

**2.** p: CSI number (p = 00), m: Unit number (m = 0), n: Channel number (n = 0), g: PIM and POM number (g = 1)

**3.**  $f_{MCK}$ : Serial array unit operation clock frequency  
(Operation clock to be set by the CKSmn bit of serial mode register mn (SMRmn). m: Unit number, n: Channel number (mn = 00))

## (9) Communication at different potential (1.8 V, 2.5 V) (CSI mode: master mode, SCKp... internal clock output)

(T<sub>A</sub> = -40 to +85°C, 1.8 V ≤ V<sub>DD</sub> = V<sub>DD\_RF</sub> = AV<sub>DD\_RF</sub> ≤ 3.6 V, V<sub>SS</sub> = V<sub>SS\_RF</sub> = AV<sub>SS\_RF</sub> = 0 V)

(1/2)

Parameter	Symbol	Conditions		HS (high-speed main) Mode		LS (low-speed main) Mode		LV (low-voltage main) Mode		Unit
				MIN.	MAX.	MIN.	MAX.	MIN.	MAX.	
SCKp cycle time Note 1	t <sub>KCY1</sub>	t <sub>KCY1</sub> ≥ 4/f <sub>CLK</sub>	2.7 V ≤ V <sub>DD</sub> ≤ 3.6 V 2.3 V ≤ V <sub>b</sub> ≤ 2.7 V C <sub>b</sub> = 30 pF, R <sub>b</sub> = 2.7 kΩ	500		1150		1150		ns
			2.4 V ≤ V <sub>DD</sub> < 3.3 V 1.6 V ≤ V <sub>b</sub> ≤ 2.0 V C <sub>b</sub> = 30 pF, R <sub>b</sub> = 5.5 kΩ	1150		1150		1150		ns
			1.8 V ≤ V <sub>DD</sub> < 3.3 V 1.6 V ≤ V <sub>b</sub> ≤ 2.0 V Note 3 C <sub>b</sub> = 30 pF, R <sub>b</sub> = 5.5 kΩ	–		1150		1150		ns
SCKp high-level width Note 1	t <sub>KH1</sub>	2.7 V ≤ V <sub>DD</sub> ≤ 3.6 V, 2.3 V ≤ V <sub>b</sub> ≤ 2.7 V C <sub>b</sub> = 30 pF, R <sub>b</sub> = 2.7 kΩ	t <sub>KCY1/2</sub> - 170		t <sub>KCY1/2</sub> - 170		t <sub>KCY1/2</sub> - 170		ns	
			2.4 V ≤ V <sub>DD</sub> < 3.3 V, 1.6 V ≤ V <sub>b</sub> ≤ 2.0 V C <sub>b</sub> = 30 pF, R <sub>b</sub> = 5.5 kΩ	t <sub>KCY1/2</sub> - 458		t <sub>KCY1/2</sub> - 458		t <sub>KCY1/2</sub> - 458		ns
			1.8 V ≤ V <sub>DD</sub> < 3.3 V, 1.6 V ≤ V <sub>b</sub> ≤ 2.0 V Note 3 C <sub>b</sub> = 30 pF, R <sub>b</sub> = 5.5 kΩ	–		t <sub>KCY1/2</sub> - 458		t <sub>KCY1/2</sub> - 458		ns
SCKp low-level width Note 1	t <sub>KL1</sub>	2.7 V ≤ V <sub>DD</sub> ≤ 3.6 V, 2.3 V ≤ V <sub>b</sub> ≤ 2.7 V C <sub>b</sub> = 30 pF, R <sub>b</sub> = 2.7 kΩ	t <sub>KCY1/2</sub> - 18		t <sub>KCY1/2</sub> - 50		t <sub>KCY1/2</sub> - 50		ns	
			2.4 V ≤ V <sub>DD</sub> < 3.3 V, 1.6 V ≤ V <sub>b</sub> ≤ 2.0 V C <sub>b</sub> = 30 pF, R <sub>b</sub> = 5.5 kΩ	t <sub>KCY1/2</sub> - 50		t <sub>KCY1/2</sub> - 50		t <sub>KCY1/2</sub> - 50		ns
			1.8 V ≤ V <sub>DD</sub> < 3.3 V, 1.6 V ≤ V <sub>b</sub> ≤ 2.0 V Note 3 C <sub>b</sub> = 30 pF, R <sub>b</sub> = 5.5 kΩ	–		t <sub>KCY1/2</sub> - 50		t <sub>KCY1/2</sub> - 50		ns
Slp setup time (to SCKp↑) Note 1, 2	t <sub>SIK1</sub>	2.7 V ≤ V <sub>DD</sub> ≤ 3.6 V, 2.3 V ≤ V <sub>b</sub> ≤ 2.7 V C <sub>b</sub> = 30 pF, R <sub>b</sub> = 2.7 kΩ	177		479		479		ns	
			2.4 V ≤ V <sub>DD</sub> < 3.3 V, 1.6 V ≤ V <sub>b</sub> ≤ 2.0 V C <sub>b</sub> = 30 pF, R <sub>b</sub> = 5.5 kΩ	479		479		479		ns
			1.8 V ≤ V <sub>DD</sub> < 3.3 V, 1.6 V ≤ V <sub>b</sub> ≤ 2.0 V Note 3 C <sub>b</sub> = 30 pF, R <sub>b</sub> = 5.5 kΩ	–		479		479		ns
Slp hold time (from SCKp↑) Note 1, 2	t <sub>SI1</sub>	2.7 V ≤ V <sub>DD</sub> ≤ 3.6 V, 2.3 V ≤ V <sub>b</sub> ≤ 2.7 V C <sub>b</sub> = 30 pF, R <sub>b</sub> = 2.7 kΩ	19		19		19		ns	
			2.4 V ≤ V <sub>DD</sub> < 3.3 V, 1.6 V ≤ V <sub>b</sub> ≤ 2.0 V C <sub>b</sub> = 30 pF, R <sub>b</sub> = 5.5 kΩ	19		19		19		ns
			1.8 V ≤ V <sub>DD</sub> < 3.3 V, 1.6 V ≤ V <sub>b</sub> ≤ 2.0 V Note 3 C <sub>b</sub> = 30 pF, R <sub>b</sub> = 5.5 kΩ	–		19		19		ns

**Note 1.** Supporting CSI00 and CSI20.**2.** When DAPmn = 0 and CKPmn = 0, or DAPmn = 1 and CKPmn = 1.**3.** Use it with V<sub>DD</sub> ≥ V<sub>b</sub>.

(Caution is listed on the next page.)

(T<sub>A</sub> = -40 to +85°C, 1.8 V ≤ V<sub>DD</sub> = V<sub>DD\_RF</sub> = AV<sub>DD\_RF</sub> ≤ 3.6 V, V<sub>SS</sub> = V<sub>SS\_RF</sub> = AV<sub>SS\_RF</sub> = 0 V)

(2/2)

Parameter	Symbol	Conditions	HS (high-speed main) Mode		LS (low-speed main) Mode		LV (low-voltage main) Mode		Unit
			MIN.	MAX.	MIN.	MAX.	MIN.	MAX.	
Delay time from SCKp↓ to SOp output <sup>Note 1, 3</sup>	t <sub>KSO1</sub>	2.7 V ≤ V <sub>DD</sub> ≤ 3.6 V 2.3 V ≤ V <sub>b</sub> ≤ 2.7 V C <sub>b</sub> = 30 pF, R <sub>b</sub> = 2.7 kΩ		195		195		195	ns
		2.4 V ≤ V <sub>DD</sub> < 3.3 V 1.6 V ≤ V <sub>b</sub> ≤ 2.0 V C <sub>b</sub> = 30 pF, R <sub>b</sub> = 5.5 kΩ		483		483		483	ns
		1.8 V ≤ V <sub>DD</sub> < 3.3 V 1.6 V ≤ V <sub>b</sub> ≤ 2.0 V <sup>Note 5</sup> C <sub>b</sub> = 30 pF, R <sub>b</sub> = 5.5 kΩ		–		483		483	ns
Slp setup time (to SCKp↓) <sup>Note 2, 4</sup>	t <sub>SIK1</sub>	2.7 V ≤ V <sub>DD</sub> ≤ 3.6 V 2.3 V ≤ V <sub>b</sub> ≤ 2.7 V C <sub>b</sub> = 30 pF, R <sub>b</sub> = 2.7 kΩ	44		110		110		ns
		2.4 V ≤ V <sub>DD</sub> < 3.3 V 1.6 V ≤ V <sub>b</sub> ≤ 2.0 V C <sub>b</sub> = 30 pF, R <sub>b</sub> = 5.5 kΩ	110		110		110		ns
		1.8 V ≤ V <sub>DD</sub> < 3.3 V 1.6 V ≤ V <sub>b</sub> ≤ 2.0 V <sup>Note 5</sup> C <sub>b</sub> = 30 pF, R <sub>b</sub> = 5.5 kΩ	–		110		110		ns
Slp hold time (from SCKp↓) <sup>Note 2, 4</sup>	t <sub>KSI1</sub>	2.7 V ≤ V <sub>DD</sub> ≤ 3.6 V 2.3 V ≤ V <sub>b</sub> ≤ 2.7 V C <sub>b</sub> = 30 pF, R <sub>b</sub> = 2.7 kΩ	19		19		19		ns
		2.4 V ≤ V <sub>DD</sub> < 3.3 V 1.6 V ≤ V <sub>b</sub> ≤ 2.0 V C <sub>b</sub> = 30 pF, R <sub>b</sub> = 5.5 kΩ	19		19		19		ns
		1.8 V ≤ V <sub>DD</sub> < 3.3 V 1.6 V ≤ V <sub>b</sub> ≤ 2.0 V <sup>Note 5</sup> C <sub>b</sub> = 30 pF, R <sub>b</sub> = 5.5 kΩ	–		19		19		ns
Delay time from SCKp↑ to SOp output <sup>Note 2, 4</sup>	t <sub>KSO1</sub>	2.7 V ≤ V <sub>DD</sub> ≤ 3.6 V 2.3 V ≤ V <sub>b</sub> ≤ 2.7 V C <sub>b</sub> = 30 pF, R <sub>b</sub> = 2.7 kΩ		25		25		25	ns
		2.4 V ≤ V <sub>DD</sub> < 3.3 V 1.6 V ≤ V <sub>b</sub> ≤ 2.0 V C <sub>b</sub> = 30 pF, R <sub>b</sub> = 5.5 kΩ		25		25		25	ns
		1.8 V ≤ V <sub>DD</sub> < 3.3 V 1.6 V ≤ V <sub>b</sub> ≤ 2.0 V <sup>Note 5</sup> C <sub>b</sub> = 30 pF, R <sub>b</sub> = 5.5 kΩ		–		25		25	ns

**Note 1.** Supporting CSI00 and CSI20.**2.** Supporting CSI00 only.**3.** When DAPmn = 0 and CKPmn = 0, or DAPmn = 1 and CKPmn = 1.**4.** When DAPmn = 0 and CKPmn = 1, or DAPmn = 1 and CKPmn = 0.**5.** Use it with V<sub>DD</sub> ≥ V<sub>b</sub>.

**Caution** Select the TTL input buffer for the Slp pin and the N-ch open drain output (V<sub>DD</sub> tolerance) mode for the SOp pin and SCKp pin by using port input mode register g (PIMg) and port output mode register g (POMg). For V<sub>IH</sub> and V<sub>IL</sub>, see the DC characteristics with TTL input buffer selected.

(Remarks are listed on the next page.)

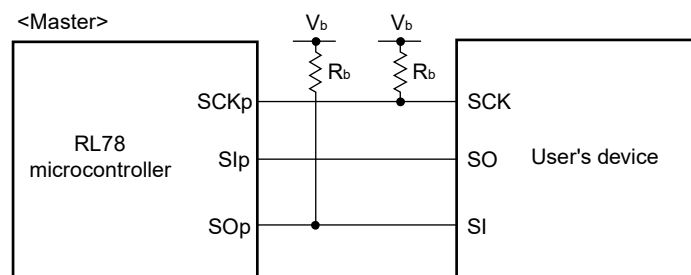
**CSI mode connection diagram (during communication at different potential)**

**Remark 1.**  $R_b[\Omega]$ : Communication line (SCKp, SOp) pull-up resistance,  $C_b[F]$ : Communication line (SCKp, SOp) load capacitance,  $V_b[V]$ : Communication line voltage

2. p: CSI number (p = 00), m: Unit number (m = 0), n: Channel number (n = 0), g: PIM and POM number (g = 1)

3.  $f_{MCK}$ : Operation clock frequency of the serial array unit  
(Operation clock to be set by the CKSmn bit of the serial mode register mn (SMRmn).  
m: Unit number, n: Channel number (mn = 00))

**CSI mode serial transfer timing (master mode) (during communication at different potential)  
(When DAPmn = 0 and CKPmn = 0, or DAPmn = 1 and CKPmn = 1.)**

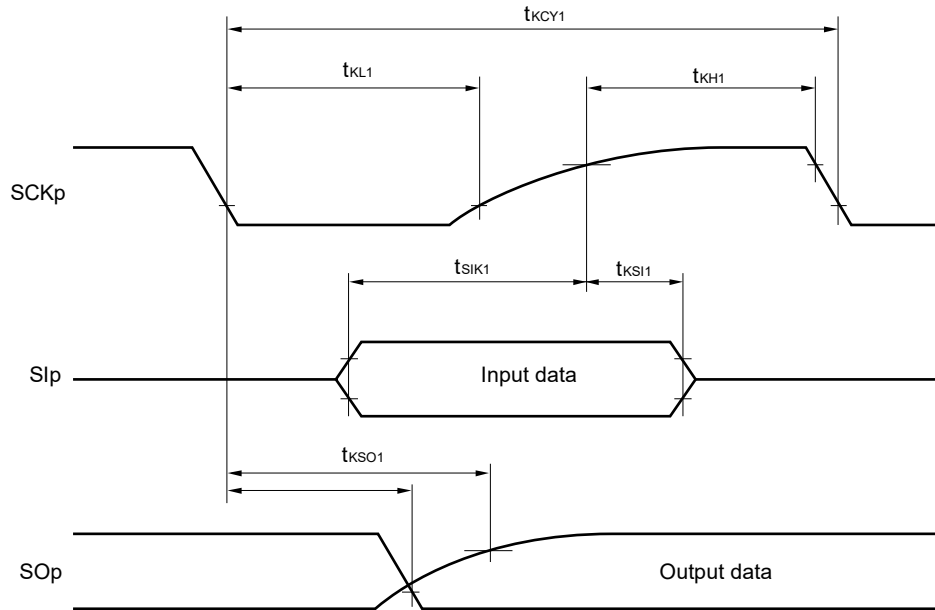

**CSI mode serial transfer timing (master mode) (during communication at different potential)  
(When DAPmn = 0 and CKPmn = 1, or DAPmn = 1 and CKPmn = 0.)**

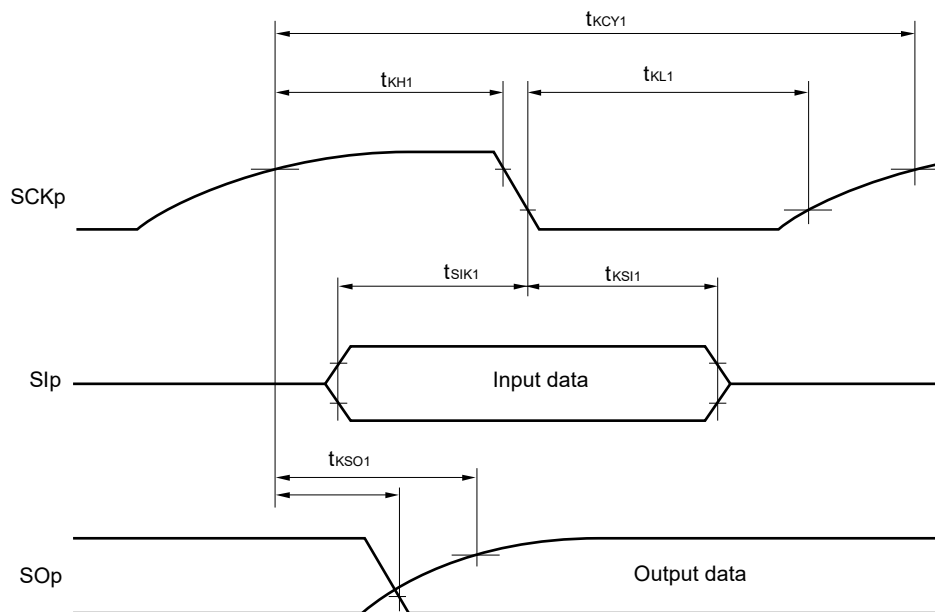

**Caution** Select the TTL input buffer for the Slp pin and the N-ch open drain output ( $V_{DD}$  tolerance) mode for the SOp pin and SCKp pin by using port input mode register g (PIMg) and port output mode register g (POMg).

**Remark** p: CSI number (p = 00), m: Unit number (m = 0), n: Channel number (n = 0), g: PIM and POM number (g = 1)

(10) Communication at different potential (1.8 V, 2.5 V) (CSI mode) (slave mode, SCKp... external clock input)

(T<sub>A</sub> = -40 to +85°C, 1.8 V ≤ V<sub>DD</sub> = V<sub>DD\_RF</sub> = AV<sub>DD\_RF</sub> ≤ 3.6 V, V<sub>SS</sub> = V<sub>SS\_RF</sub> = AV<sub>SS\_RF</sub> = 0 V)

(1/2)

Parameter	Symbol	Conditions		HS (high-speed main) Mode		LS (low-speed main) Mode		LV (low-voltage main) Mode		Unit
				MIN.	MAX.	MIN.	MAX.	MIN.	MAX.	
SCKp cycle time <sup>Note 1</sup>	t <sub>KCY2</sub>	2.7 V ≤ V <sub>DD</sub> ≤ 3.6 V 2.3 V ≤ V <sub>b</sub> ≤ 2.7 V	24 MHz < f <sub>MCK</sub>	20/ f <sub>MCK</sub>		-		-		ns
			20 MHz < f <sub>MCK</sub> ≤ 24 MHz	16/ f <sub>MCK</sub>		-		-		ns
			16 MHz < f <sub>MCK</sub> ≤ 20 MHz	14/ f <sub>MCK</sub>		-		-		ns
			8 MHz < f <sub>MCK</sub> ≤ 16 MHz	12/ f <sub>MCK</sub>		-		-		ns
			4 MHz < f <sub>MCK</sub> ≤ 8 MHz	8/f <sub>MCK</sub>		16/ f <sub>MCK</sub>		-		ns
			f <sub>MCK</sub> ≤ 4MHz	6/f <sub>MCK</sub>		10/ f <sub>MCK</sub>		10/ f <sub>MCK</sub>		ns
		2.4 V ≤ V <sub>DD</sub> < 3.3 V 1.6 V ≤ V <sub>b</sub> ≤ 2.0 V	24 MHz < f <sub>MCK</sub>	48/ f <sub>MCK</sub>		-		-		ns
			20 MHz < f <sub>MCK</sub> ≤ 24 MHz	36/ f <sub>MCK</sub>		-		-		ns
			16 MHz < f <sub>MCK</sub> ≤ 20 MHz	32/ f <sub>MCK</sub>		-		-		ns
			8 MHz < f <sub>MCK</sub> ≤ 16 MHz	26/ f <sub>MCK</sub>		-		-		ns
			4 MHz < f <sub>MCK</sub> ≤ 8 MHz	16/ f <sub>MCK</sub>		16/ f <sub>MCK</sub>		-		ns
			f <sub>MCK</sub> ≤ 4MHz	10/ f <sub>MCK</sub>		10/ f <sub>MCK</sub>		10/ f <sub>MCK</sub>		ns
		1.8 V ≤ V <sub>DD</sub> < 3.3 V 1.6 V ≤ V <sub>b</sub> ≤ 2.0 V <sup>Note 2</sup>	24 MHz < f <sub>MCK</sub>	-		-		-		ns
			20 MHz < f <sub>MCK</sub> ≤ 24 MHz	-		-		-		ns
			16 MHz < f <sub>MCK</sub> ≤ 20 MHz	-		-		-		ns
			8 MHz < f <sub>MCK</sub> ≤ 16 MHz	-		-		-		ns
			4 MHz < f <sub>MCK</sub> ≤ 8 MHz	-		16/ f <sub>MCK</sub>		-		ns
			f <sub>MCK</sub> ≤ 4MHz	-		10/ f <sub>MCK</sub>		10/ f <sub>MCK</sub>		ns

(Notes and Caution are listed on the next page.)

(T<sub>A</sub> = -40 to +85°C, 1.8 V ≤ V<sub>DD</sub> = V<sub>DD\_RF</sub> = AV<sub>DD\_RF</sub> ≤ 3.6 V, V<sub>SS</sub> = V<sub>SS\_RF</sub> = AV<sub>SS\_RF</sub> = 0 V)

(2/2)

Parameter	Symbol	Conditions	HS (high-speed main) Mode		LS (low-speed main) Mode		LV (low-voltage main) Mode		Unit
			MIN.	MAX.	MIN.	MAX.	MIN.	MAX.	
SCKp high-/low-level width	t <sub>KH2</sub> , t <sub>KL2</sub>	2.7 V ≤ V <sub>DD</sub> ≤ 3.6 V 2.3 V ≤ V <sub>b</sub> ≤ 2.7 V	t <sub>KCY2</sub> /2 – 18		t <sub>KCY2</sub> /2 – 50		t <sub>KCY2</sub> /2 – 50		ns
		2.4 V ≤ V <sub>DD</sub> < 3.3 V 1.6 V ≤ V <sub>b</sub> ≤ 2.0 V	t <sub>KCY2</sub> /2 – 50		t <sub>KCY2</sub> /2 – 50		t <sub>KCY2</sub> /2 – 50		ns
		1.8 V ≤ V <sub>DD</sub> < 3.3 V 1.6 V ≤ V <sub>b</sub> ≤ 2.0 V <sup>Note 2</sup>	–		t <sub>KCY2</sub> /2 – 50		t <sub>KCY2</sub> /2 – 50		ns
Slp setup time (to SCKp↑) <sup>Note 3</sup>	t <sub>SIK2</sub>	2.7 V ≤ V <sub>DD</sub> ≤ 3.6 V 2.3 V ≤ V <sub>b</sub> ≤ 4.0 V	1/f <sub>MCK</sub> + 20		1/f <sub>MCK</sub> + 30		1/f <sub>MCK</sub> + 30		ns
		2.4 V ≤ V <sub>DD</sub> < 3.3 V 1.6 V ≤ V <sub>b</sub> ≤ 2.0 V	1/f <sub>MCK</sub> + 30		1/f <sub>MCK</sub> + 30		1/f <sub>MCK</sub> + 30		ns
		1.8 V ≤ V <sub>DD</sub> < 3.3 V 1.6 V ≤ V <sub>b</sub> ≤ 2.0 V <sup>Note 2</sup>	–		1/f <sub>MCK</sub> + 30		1/f <sub>MCK</sub> + 30		ns
Slp hold time (from SCKp↑) <sup>Note 3</sup>	t <sub>SI2</sub>	2.7 V ≤ V <sub>DD</sub> ≤ 3.6 V 2.3 V ≤ V <sub>b</sub> ≤ 4.0 V	1/f <sub>MCK</sub> + 31		1/f <sub>MCK</sub> + 31		1/f <sub>MCK</sub> + 31		ns
		2.4 V ≤ V <sub>DD</sub> < 3.3 V 1.6 V ≤ V <sub>b</sub> ≤ 2.0 V	1/f <sub>MCK</sub> + 31		1/f <sub>MCK</sub> + 31		1/f <sub>MCK</sub> + 31		ns
		1.8 V ≤ V <sub>DD</sub> < 3.3 V 1.6 V ≤ V <sub>b</sub> ≤ 2.0 V <sup>Note 2</sup>	–		1/f <sub>MCK</sub> + 31		1/f <sub>MCK</sub> + 31		ns
Delay time from SCKp↓ to SOp output <sup>Note 4</sup>	t <sub>KSO2</sub>	2.7 V ≤ V <sub>DD</sub> < 3.6 V 2.3 V ≤ V <sub>b</sub> ≤ 2.7 V C <sub>b</sub> = 30 pF, R <sub>b</sub> = 2.7 kΩ		2/f <sub>MCK</sub> + 214		2/f <sub>MCK</sub> + 573		2/f <sub>MCK</sub> + 573	ns
		2.4 V ≤ V <sub>DD</sub> < 3.3 V 1.6 V ≤ V <sub>b</sub> ≤ 2.0 V C <sub>b</sub> = 30 pF, R <sub>b</sub> = 5.5 kΩ		2/f <sub>MCK</sub> + 573		2/f <sub>MCK</sub> + 573		2/f <sub>MCK</sub> + 573	ns
		1.8 V ≤ V <sub>DD</sub> < 3.3 V 1.6 V ≤ V <sub>b</sub> ≤ 2.0 V <sup>Note 2</sup> C <sub>b</sub> = 30 pF, R <sub>b</sub> = 5.5 kΩ		–		2/f <sub>MCK</sub> + 573		2/f <sub>MCK</sub> + 573	ns

**Note 1.** Transfer rate in the SNOOZE mode : MAX. 1 Mbps**2.** Use it with V<sub>DD</sub> ≥ V<sub>b</sub>.**3.** When DAPmn = 0 and CKPmn = 0, or DAPmn = 1 and CKPmn = 1. The Slp time becomes “to SCKp↓” when DAPmn = 0 and CKPmn = 1, or DAPmn = 1 and CKPmn = 0.**4.** When DAPmn = 0 and CKPmn = 0, or DAPmn = 1 and CKPmn = 1. The delay time to SOp output becomes “from SCKp↑” when DAPmn = 0 and CKPmn = 1, or DAPmn = 1 and CKPmn = 0.

**Caution** Select the TTL input buffer for the Slp pin and SCKp pin and the N-ch open drain output (V<sub>DD</sub> tolerance) mode for the SOp pin by using port input mode register g (PIMg) and port output mode register g (POMg). For V<sub>IH</sub> and V<sub>IL</sub>, see the DC characteristics with TTL input buffer selected.

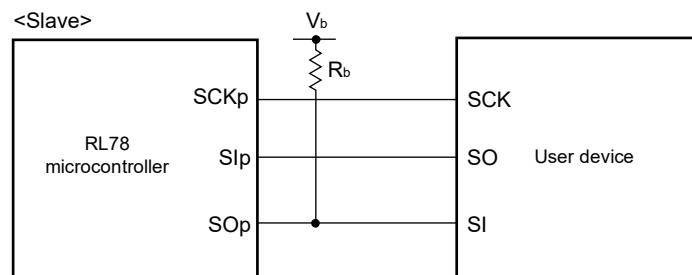

**CSI mode connection diagram (during communication at different potential)**

- Remark 1.**  $R_b[\Omega]$ : Communication line (SO<sub>p</sub>) pull-up resistance,  $C_b[F]$ : Communication line (SO<sub>p</sub>) load capacitance,  $V_b[V]$ : Communication line voltage
2. p: CSI number (p = 00, 20), m: Unit number, n: Channel number (mn = 00, 10), g: PIM and POM number (g = 0, 1)
  3.  $f_{MCK}$ : Serial array unit operation clock frequency  
(Operation clock to be set by the CKSmn bit of serial mode register mn (SMRmn).  
m: Unit number, n: Channel number (mn = 00, 10))

**CSI mode serial transfer timing (slave mode) (during communication at different potential)  
(When DAPmn = 0 and CKPmn = 0, or DAPmn = 1 and CKPmn = 1.)**

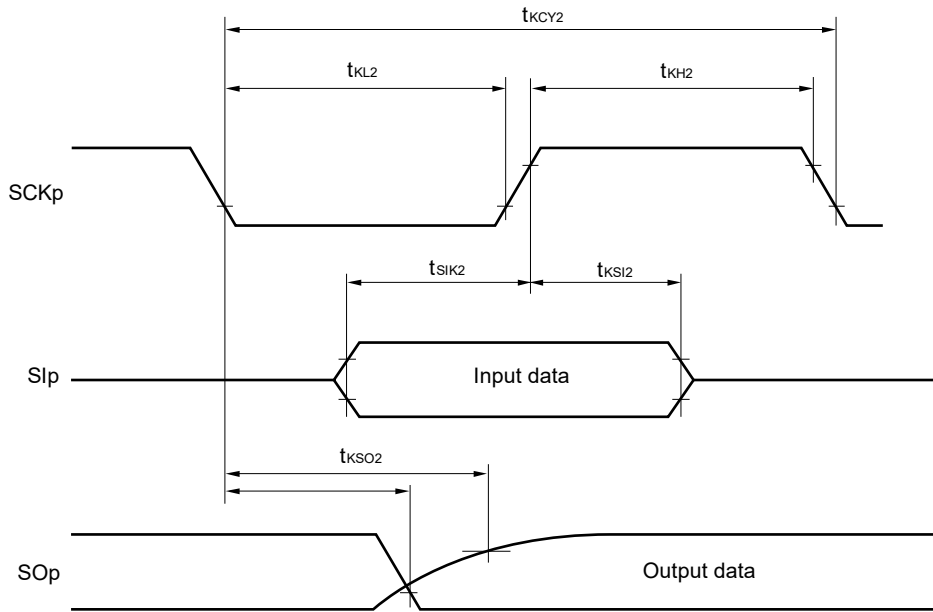

**CSI mode serial transfer timing (slave mode) (during communication at different potential)  
(When DAPmn = 0 and CKPmn = 1, or DAPmn = 1 and CKPmn = 0.)**

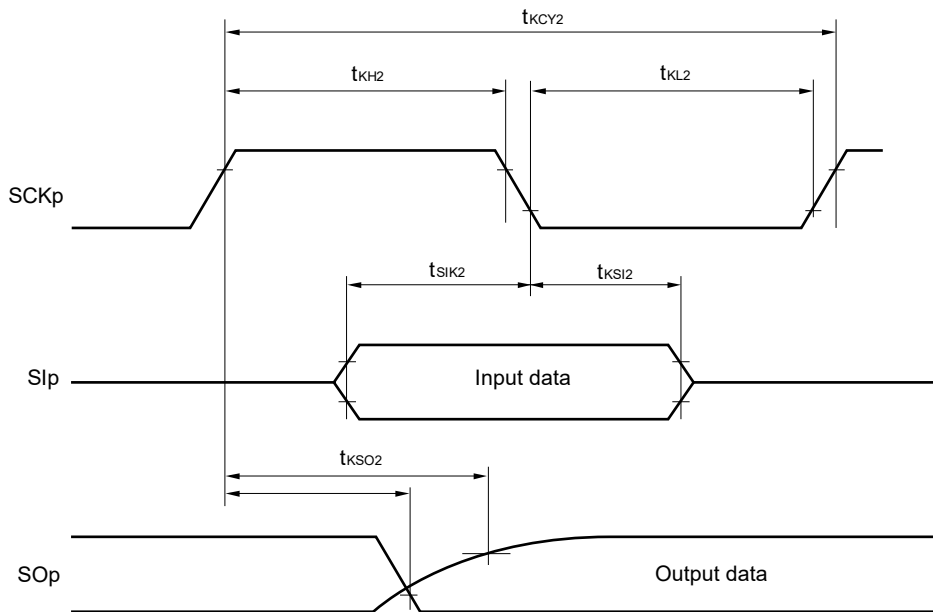

**Caution** Select the TTL input buffer for the SIp pin and the N-ch open drain output ( $V_{DD}$  tolerance) mode for the SOp pin and SCKp pin by using port input mode register g (PIMg) and port output mode register g (POMg).

**Remark** p: CSI number (p = 00), m: Unit number (m = 0), n: Channel number (n = 0), g: PIM and POM number (g = 1)

(11) Communication at different potential (1.8 V, 2.5 V) (simplified I<sup>2</sup>C mode)(T<sub>A</sub> = -40 to +85°C, 1.8 V ≤ V<sub>DD</sub> = V<sub>DD\_RF</sub> = AV<sub>DD\_RF</sub> ≤ 3.6 V, V<sub>SS</sub> = V<sub>SS\_RF</sub> = AV<sub>SS\_RF</sub> = 0 V)

(1/2)

Parameter	Symbol	Conditions	HS (high-speed main) Mode		LS (low-speed main) Mode		LV (low-voltage main) Mode		Unit
			MIN.	MAX.	MIN.	MAX.	MIN.	MAX.	
SCLr clock frequency	f <sub>SCL</sub>	2.7 V ≤ V <sub>DD</sub> ≤ 3.6 V 2.3 V ≤ V <sub>b</sub> ≤ 2.7 V C <sub>b</sub> = 50 pF, R <sub>b</sub> = 2.7 kΩ		1000 Note 1		300 Note 5		300 Note 5	kHz
		2.7 V ≤ V <sub>DD</sub> ≤ 3.6 V 2.3 V ≤ V <sub>b</sub> ≤ 2.7 V C <sub>b</sub> = 100 pF, R <sub>b</sub> = 2.7 kΩ		400 Note 1		300 Note 5		300 Note 5	kHz
		2.4 V ≤ V <sub>DD</sub> < 3.3 V 1.6 V ≤ V <sub>b</sub> ≤ 2.0 V C <sub>b</sub> = 100 pF, R <sub>b</sub> = 5.5 kΩ		300 Note 1		300 Note 1		300 Note 1	kHz
		1.8 V ≤ V <sub>DD</sub> < 3.3 V 1.6 V ≤ V <sub>b</sub> ≤ 2.0 V <sup>Note 2</sup> C <sub>b</sub> = 100 pF, R <sub>b</sub> = 5.5 kΩ		–		300 Note 1		300 Note 1	kHz
Hold time when SCLr = "L"	t <sub>LOW</sub>	2.7 V ≤ V <sub>DD</sub> ≤ 3.6 V 2.3 V ≤ V <sub>b</sub> ≤ 2.7 V C <sub>b</sub> = 50 pF, R <sub>b</sub> = 2.7 kΩ	475		1550		1550		ns
		2.7 V ≤ V <sub>DD</sub> ≤ 3.6 V 2.3 V ≤ V <sub>b</sub> ≤ 2.7 V C <sub>b</sub> = 100 pF, R <sub>b</sub> = 2.7 kΩ	1150		1550		1550		ns
		2.4 V ≤ V <sub>DD</sub> < 3.3 V 1.6 V ≤ V <sub>b</sub> ≤ 2.0 V C <sub>b</sub> = 100 pF, R <sub>b</sub> = 5.5 kΩ	1150		1550		1550		ns
		1.8 V ≤ V <sub>DD</sub> < 3.3 V 1.6 V ≤ V <sub>b</sub> ≤ 2.0 V <sup>Note 2</sup> C <sub>b</sub> = 100 pF, R <sub>b</sub> = 5.5 kΩ	–		1550		1550		ns
Hold time when SCLr = "H"	t <sub>HIGH</sub>	2.7 V ≤ V <sub>DD</sub> ≤ 3.6 V 2.3 V ≤ V <sub>b</sub> ≤ 2.7 V C <sub>b</sub> = 50 pF, R <sub>b</sub> = 2.7 kΩ	200		610		610		ns
		2.7 V ≤ V <sub>DD</sub> ≤ 3.6 V 2.3 V ≤ V <sub>b</sub> ≤ 2.7 V C <sub>b</sub> = 100 pF, R <sub>b</sub> = 2.7 kΩ	600		610		610		ns
		2.4 V ≤ V <sub>DD</sub> < 3.3 V 1.6 V ≤ V <sub>b</sub> ≤ 2.0 V C <sub>b</sub> = 100 pF, R <sub>b</sub> = 5.5 kΩ	610		610		610		ns
		1.8 V ≤ V <sub>DD</sub> < 3.3 V 1.6 V ≤ V <sub>b</sub> ≤ 2.0 V <sup>Note 2</sup> C <sub>b</sub> = 100 pF, R <sub>b</sub> = 5.5 kΩ	–		610		610		ns

(Note, Caution and Remarks are listed on the next page.)

(T<sub>A</sub> = -40 to +85°C, 1.8 V ≤ V<sub>DD</sub> = V<sub>DD\_RF</sub> = AV<sub>DD\_RF</sub> ≤ 3.6 V, V<sub>SS</sub> = V<sub>SS\_RF</sub> = AV<sub>SS\_RF</sub> = 0 V)

(2/2)

Parameter	Symbol	Conditions	HS (high-speed main) Mode		LS (low-speed main) Mode		LV (low-voltage main) Mode		Unit
			MIN.	MAX.	MIN.	MAX.	MIN.	MAX.	
Data setup time (reception)	t <sub>SU:DAT</sub>	2.7 V ≤ V <sub>DD</sub> ≤ 3.6 V 2.3 V ≤ V <sub>b</sub> ≤ 2.7 V C <sub>b</sub> = 50 pF, R <sub>b</sub> = 2.7 kΩ	1/f <sub>MCK</sub> + 135 Note 3		1/f <sub>MCK</sub> + 190 Note 3		1/f <sub>MCK</sub> + 190 Note 3		ns
		2.7 V ≤ V <sub>DD</sub> ≤ 3.6 V 2.3 V ≤ V <sub>b</sub> ≤ 2.7 V C <sub>b</sub> = 100 pF, R <sub>b</sub> = 2.7 kΩ	1/f <sub>MCK</sub> + 190 Note 3		1/f <sub>MCK</sub> + 190 Note 3		1/f <sub>MCK</sub> + 190 Note 3		ns
		2.4 V ≤ V <sub>DD</sub> < 3.3 V 1.6 V ≤ V <sub>b</sub> ≤ 2.0 V C <sub>b</sub> = 100 pF, R <sub>b</sub> = 5.5 kΩ	1/f <sub>MCK</sub> + 190 Note 3		1/f <sub>MCK</sub> + 190 Note 3		1/f <sub>MCK</sub> + 190 Note 3		ns
		1.8 V ≤ V <sub>DD</sub> < 3.3 V 1.6 V ≤ V <sub>b</sub> ≤ 2.0 V Note 2 C <sub>b</sub> = 100 pF, R <sub>b</sub> = 5.5 kΩ	–		1/f <sub>MCK</sub> + 190 Note 3		1/f <sub>MCK</sub> + 190 Note 3		ns
Data hold time (transmission)	t <sub>HD:DAT</sub>	2.7 V ≤ V <sub>DD</sub> ≤ 3.6 V 2.3 V ≤ V <sub>b</sub> ≤ 2.7 V C <sub>b</sub> = 50 pF, R <sub>b</sub> = 2.7 kΩ	0 Note 4	305	0 Note 4	305	0 Note 4	305	ns
		2.7 V ≤ V <sub>DD</sub> ≤ 3.6 V 2.3 V ≤ V <sub>b</sub> ≤ 2.7 V C <sub>b</sub> = 100 pF, R <sub>b</sub> = 2.7 kΩ	0 Note 4	355	0 Note 4	355	0 Note 4	355	ns
		2.4 V ≤ V <sub>DD</sub> < 3.3 V 1.6 V ≤ V <sub>b</sub> ≤ 2.0 V C <sub>b</sub> = 100 pF, R <sub>b</sub> = 5.5 kΩ	0 Note 4	405	0 Note 4	405	0 Note 4	405	ns
		1.8 V ≤ V <sub>DD</sub> < 3.3 V 1.6 V ≤ V <sub>b</sub> ≤ 2.0 V Note 2 C <sub>b</sub> = 100 pF, R <sub>b</sub> = 5.5 kΩ	–	–	0 Note 4	405	0 Note 4	405	ns

**Note 1.** The value must also be f<sub>MCK</sub>/4 or lower.**2.** Use it with V<sub>DD</sub> ≥ V<sub>b</sub>.**3.** Set the f<sub>MCK</sub> value to keep the hold time of SCLr = "L" and SCLr = "H".

**Caution** Select the TTL input buffer and the N-ch open drain output (V<sub>DD</sub> tolerance) mode for the SDAr pin and the N-ch open drain output (V<sub>DD</sub> tolerance) mode for the SCLr pin by using port input mode register g (PIMg) and port output mode register g (POMg). For V<sub>IH</sub> and V<sub>IL</sub>, see the DC characteristics with TTL input buffer selected.

**Simplified I<sup>2</sup>C mode connection diagram (during communication at different potential)**

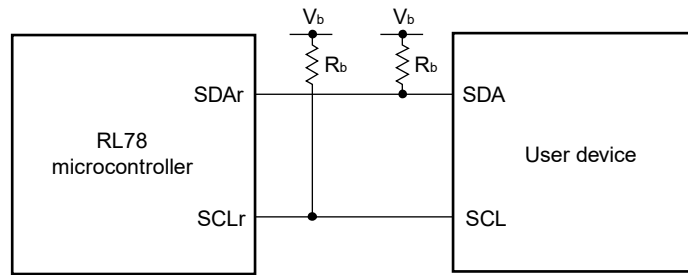

**Simplified I<sup>2</sup>C mode serial transfer timing (during communication at different potential)**

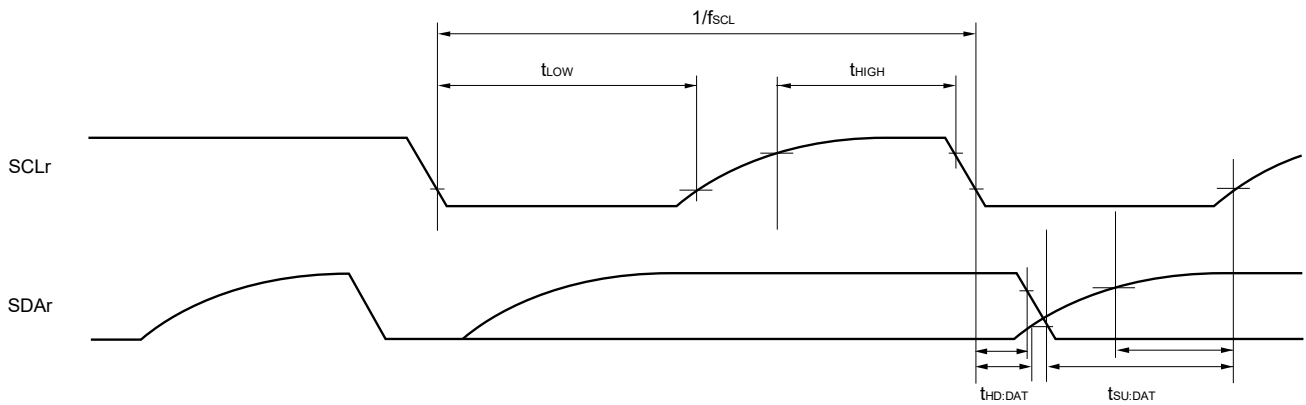

- Remark 1.**  $R_b$ [ $\Omega$ ]: Communication line (SDAr, SCLr) pull-up resistance,  $C_b$ [F]: Communication line (SDAr, SCLr) load capacitance,  $V_b$ [V]: Communication line voltage
- 2.** r: IIC number (r = 00, 10), g: PIM, POM number (g = 0, 1)
- 3.**  $f_{MCK}$ : Serial array unit operation clock frequency  
 (Operation clock to be set by the CKSmn bit of serial mode register mn (SMRmn). m: Unit number, n: Channel number (mn = 00, 02))

## 2.7.2 Serial interface IICA

(1) I<sup>2</sup>C standard mode(T<sub>A</sub> = -40 to +85°C, 1.6 V ≤ V<sub>DD</sub> = V<sub>DD\_RF</sub> = AV<sub>DD\_RF</sub> ≤ 3.6 V, V<sub>SS</sub> = V<sub>SS\_RF</sub> = AV<sub>SS\_RF</sub> = 0 V)

Parameter	Symbol	Conditions	HS (high-speed main) Mode		LS (low-speed main) Mode		LV (low-voltage main) Mode		Unit	
			MIN.	MAX.	MIN.	MAX.	MIN.	MAX.		
			SCLA0 clock frequency	f <sub>SCL</sub>	Standard mode: f <sub>CLK</sub> ≥ 1 MHz	2.7 V ≤ V <sub>DD</sub> ≤ 3.6 V	0	100		0
			2.4 V ≤ V <sub>DD</sub> ≤ 3.6 V	0	100	0	100	0	100	kHz
			1.8 V ≤ V <sub>DD</sub> ≤ 3.6 V	-		0	100	0	100	kHz
			1.6 V ≤ V <sub>DD</sub> ≤ 3.6 V	-		-		0	100	kHz
Setup time of restart condition	t <sub>SU:STA</sub>	2.7 V ≤ V <sub>DD</sub> ≤ 3.6 V	4.7		4.7		4.7		μs	
		2.4 V ≤ V <sub>DD</sub> ≤ 3.6 V	4.7		4.7		4.7		μs	
		1.8 V ≤ V <sub>DD</sub> ≤ 3.6 V	-		4.7		4.7		μs	
		1.6 V ≤ V <sub>DD</sub> ≤ 3.6 V	-		-		4.7		μs	
Hold time <sup>Note 1</sup>	t <sub>HD:STA</sub>	2.7 V ≤ V <sub>DD</sub> ≤ 3.6 V	4.0		4.0		4.0		μs	
		2.4 V ≤ V <sub>DD</sub> ≤ 3.6 V	4.0		4.0		4.0		μs	
		1.8 V ≤ V <sub>DD</sub> ≤ 3.6 V	-		4.0		4.0		μs	
		1.6 V ≤ V <sub>DD</sub> ≤ 3.6 V	-		-		4.0		μs	
Hold time when SCLA0 = "L"	t <sub>LOW</sub>	2.7 V ≤ V <sub>DD</sub> ≤ 3.6 V	4.7		4.7		4.7		μs	
		2.4 V ≤ V <sub>DD</sub> ≤ 3.6 V	4.7		4.7		4.7		μs	
		1.8 V ≤ V <sub>DD</sub> ≤ 3.6 V	-		4.7		4.7		μs	
		1.6 V ≤ V <sub>DD</sub> ≤ 3.6 V	-		-		4.7		μs	
Hold time when SCLA0 = "H"	t <sub>HIGH</sub>	2.7 V ≤ V <sub>DD</sub> ≤ 3.6 V	4.0		4.0		4.0		μs	
		2.4 V ≤ V <sub>DD</sub> ≤ 3.6 V	4.0		4.0		4.0		μs	
		1.8 V ≤ V <sub>DD</sub> ≤ 3.6 V	-		4.0		4.0		μs	
		1.6 V ≤ V <sub>DD</sub> ≤ 3.6 V	-		-		4.0		μs	
Data setup time (reception)	t <sub>SU:DAT</sub>	2.7 V ≤ V <sub>DD</sub> ≤ 3.6 V	250		250		250		ns	
		2.4 V ≤ V <sub>DD</sub> ≤ 3.6 V	250		250		250		ns	
		1.8 V ≤ V <sub>DD</sub> ≤ 3.6 V	-		250		250		ns	
		1.6 V ≤ V <sub>DD</sub> ≤ 3.6 V	-		-		250		ns	
Data hold time (transmission) <sup>Note 2</sup>	t <sub>HD:DAT</sub>	2.7 V ≤ V <sub>DD</sub> ≤ 3.6 V	0	3.45	0	3.45	0	3.45	μs	
		2.4 V ≤ V <sub>DD</sub> ≤ 3.6 V	0	3.45	0	3.45	0	3.45	μs	
		1.8 V ≤ V <sub>DD</sub> ≤ 3.6 V	-		0	3.45	0	3.45	μs	
		1.6 V ≤ V <sub>DD</sub> ≤ 3.6 V	-		-		0	3.45	μs	
Setup time of stop condition	t <sub>SU:STO</sub>	2.7 V ≤ V <sub>DD</sub> ≤ 3.6 V	4.0		4.0		4.0		μs	
		2.4 V ≤ V <sub>DD</sub> ≤ 3.6 V	4.0		4.0		4.0		μs	
		1.8 V ≤ V <sub>DD</sub> ≤ 3.6 V	-		4.0		4.0		μs	
		1.6 V ≤ V <sub>DD</sub> ≤ 3.6 V	-		-		4.0		μs	
Bus-free time	t <sub>BUF</sub>	2.7 V ≤ V <sub>DD</sub> ≤ 3.6 V	4.7		4.7		4.7		μs	
		2.4 V ≤ V <sub>DD</sub> ≤ 3.6 V	4.7		4.7		4.7		μs	
		1.8 V ≤ V <sub>DD</sub> ≤ 3.6 V	-		4.7		4.7		μs	
		1.6 V ≤ V <sub>DD</sub> ≤ 3.6 V	-		-		4.7		μs	

(Notes, Caution and Remark are listed on the next page.)

&lt;R&gt;

- Note**
1. The first clock pulse is generated after this period when the start/restart condition is detected.
  2. The maximum value (MAX.) of  $t_{HD:DAT}$  is during normal transfer and a wait state is inserted in the ACK (acknowledge) timing.

**Caution** The values in the above table are applied even when bit 2 (PIOR2) in the peripheral I/O redirection register (PIOR) is 1. At this time, the pin characteristics ( $I_{OH1}$ ,  $I_{OL1}$ ,  $V_{OH1}$ ,  $V_{OL1}$ ) must satisfy the values in the redirect destination.

**Remark** The maximum value of  $C_b$  (communication line capacitance) and the value of  $R_b$  (communication line pull-up resistor) at that time in each mode are as follows.  
Standard mode:  $C_b = 400$  pF,  $R_b = 2.7$  k $\Omega$

(2) I<sup>2</sup>C fast mode

(TA = -40 to +85°C, 1.8 V ≤ VDD = VDD\_RF = AVDD\_RF ≤ 3.6 V, VSS = VSS\_RF = AVSS\_RF = 0 V)

Parameter	Symbol	Conditions	HS (high-speed main) Mode		LS (low-speed main) Mode		LV (low-voltage main) Mode		Unit	
			MIN.	MAX.	MIN.	MAX.	MIN.	MAX.		
SCLA0 clock frequency	f <sub>SCL</sub>	Fast mode: f <sub>CLK</sub> ≥ 3.5 MHz	2.7 V ≤ V <sub>DD</sub> ≤ 3.6 V	0	400	0	400	0	400	kHz
			2.4 V ≤ V <sub>DD</sub> ≤ 3.6 V	0	400	0	400	0	400	kHz
			1.8 V ≤ V <sub>DD</sub> ≤ 3.6 V	-		0	400	0	400	kHz
Setup time of restart condition	t <sub>SU:STA</sub>	2.7 V ≤ V <sub>DD</sub> ≤ 3.6 V	0.6		0.6		0.6		μs	
		2.4 V ≤ V <sub>DD</sub> ≤ 3.6 V	0.6		0.6		0.6		μs	
		1.8 V ≤ V <sub>DD</sub> ≤ 3.6 V	-		0.6		0.6		μs	
Hold time <sup>Note 1</sup>	t <sub>HD:STA</sub>	2.7 V ≤ V <sub>DD</sub> ≤ 3.6 V	0.6		0.6		0.6		μs	
		2.4 V ≤ V <sub>DD</sub> ≤ 3.6 V	0.6		0.6		0.6		μs	
		1.8 V ≤ V <sub>DD</sub> ≤ 3.6 V	-		0.6		0.6		μs	
Hold time when SCLA0 = "L"	t <sub>LOW</sub>	2.7 V ≤ V <sub>DD</sub> ≤ 3.6 V	1.3		1.3		1.3		μs	
		2.4 V ≤ V <sub>DD</sub> ≤ 3.6 V	1.3		1.3		1.3		μs	
		1.8 V ≤ V <sub>DD</sub> ≤ 3.6 V	-		1.3		1.3		μs	
Hold time when SCLA0 = "H"	t <sub>HIGH</sub>	2.7 V ≤ V <sub>DD</sub> ≤ 3.6 V	0.6		0.6		0.6		μs	
		2.4 V ≤ V <sub>DD</sub> ≤ 3.6 V	0.6		0.6		0.6		μs	
		1.8 V ≤ V <sub>DD</sub> ≤ 3.6 V	-		0.6		0.6		μs	
Data setup time (reception)	t <sub>SU:DAT</sub>	2.7 V ≤ V <sub>DD</sub> ≤ 3.6 V	100		100		100		μs	
		2.4 V ≤ V <sub>DD</sub> ≤ 3.6 V	100		100		100		μs	
		1.8 V ≤ V <sub>DD</sub> ≤ 3.6 V	-		100		100		μs	
Data hold time (transmission) <sup>Note 2</sup>	t <sub>HD:DAT</sub>	2.7 V ≤ V <sub>DD</sub> ≤ 3.6 V	0	0.9	0	0.9	0	0.9	μs	
		2.4 V ≤ V <sub>DD</sub> ≤ 3.6 V	0	0.9	0	0.9	0	0.9	μs	
		1.8 V ≤ V <sub>DD</sub> ≤ 3.6 V	-		0	0.9	0	0.9	μs	
Setup time of stop condition	t <sub>SU:STO</sub>	2.7 V ≤ V <sub>DD</sub> ≤ 3.6 V	0.6		0.6		0.6		μs	
		2.4 V ≤ V <sub>DD</sub> ≤ 3.6 V	0.6		0.6		0.6		μs	
		1.8 V ≤ V <sub>DD</sub> ≤ 3.6 V	-		0.6		0.6		μs	
Bus-free time	t <sub>BUF</sub>	2.7 V ≤ V <sub>DD</sub> ≤ 3.6 V	1.3		1.3		1.3		μs	
		2.4 V ≤ V <sub>DD</sub> ≤ 3.6 V	1.3		1.3		1.3		μs	
		1.8 V ≤ V <sub>DD</sub> ≤ 3.6 V	-		1.3		1.3		μs	

**Note 1.** The first clock pulse is generated after this period when the start/restart condition is detected.

<R> **2.** The maximum value (MAX.) of t<sub>HD:DAT</sub> is during normal transfer and a wait state is inserted in the ACK (acknowledge) timing.

**Caution** The values in the above table are applied even when bit 2 (PIOR2) in the peripheral I/O redirection register (PIOR) is 1. At this time, the pin characteristics (I<sub>OH1</sub>, I<sub>OL1</sub>, V<sub>OH1</sub>, V<sub>OL1</sub>) must satisfy the values in the redirect destination.

**Remark** The maximum value of C<sub>b</sub> (communication line capacitance) and the value of R<sub>b</sub> (communication line pull-up resistor) at that time in each mode are as follows.

Fast mode: C<sub>b</sub> = 320 pF, R<sub>b</sub> = 1.1 kΩ



(3) I<sup>2</sup>C fast mode plus

(T<sub>A</sub> = -40 to +85°C, 2.7 V ≤ V<sub>DD</sub> = V<sub>DD\_RF</sub> = AV<sub>DD\_RF</sub> ≤ 3.6 V, V<sub>SS</sub> = V<sub>SS\_RF</sub> = AV<sub>SS\_RF</sub> = 0 V)

Parameter	Symbol	Conditions	HS (high-speed main) Mode		LS (low-speed main) Mode		LV (low-voltage main) Mode		Unit
			MIN.	MAX.	MIN.	MAX.	MIN.	MAX.	
SCLA0 clock frequency	f <sub>SCL</sub>	Fast mode plus: f <sub>CLK</sub> ≥ 10 MHz 2.7 V ≤ V <sub>DD</sub> ≤ 3.6 V	0	1000	–	–	–	–	kHz
Setup time of restart condition	t <sub>SU:STA</sub>	2.7 V ≤ V <sub>DD</sub> ≤ 3.6 V	0.26		–	–	–	–	μs
Hold time <sup>Note 1</sup>	t <sub>HD:STA</sub>	2.7 V ≤ V <sub>DD</sub> ≤ 3.6 V	0.26		–	–	–	–	μs
Hold time when SCLA0 = "L"	t <sub>LOW</sub>	2.7 V ≤ V <sub>DD</sub> ≤ 3.6 V	0.5		–	–	–	–	μs
Hold time when SCLA0 = "H"	t <sub>HIGH</sub>	2.7 V ≤ V <sub>DD</sub> ≤ 3.6 V	0.26		–	–	–	–	μs
Data setup time (reception)	t <sub>SU:DAT</sub>	2.7 V ≤ V <sub>DD</sub> ≤ 3.6 V	50		–	–	–	–	μs
Data hold time (transmission) <sup>Note 2</sup>	t <sub>HD:DAT</sub>	2.7 V ≤ V <sub>DD</sub> ≤ 3.6 V	0	0.45	–	–	–	–	μs
Setup time of stop condition	t <sub>SU:STO</sub>	2.7 V ≤ V <sub>DD</sub> ≤ 3.6 V	0.26		–	–	–	–	μs
Bus-free time	t <sub>BUF</sub>	2.7 V ≤ V <sub>DD</sub> ≤ 3.6 V	0.5		–	–	–	–	μs

**Note 1.** The first clock pulse is generated after this period when the start/restart condition is detected.

**2.** The maximum value (MAX.) of t<sub>HD:DAT</sub> is during normal transfer and a wait state is inserted in the ACK (acknowledge) timing.

<R>

**Caution** The values in the above table are applied even when bit 2 (PIOR2) in the peripheral I/O redirection register (PIOR) is 1. At this time, the pin characteristics (I<sub>OH1</sub>, I<sub>OL1</sub>, V<sub>OH1</sub>, V<sub>OL1</sub>) must satisfy the values in the redirect destination.

**Remark** The maximum value of C<sub>b</sub> (communication line capacitance) and the value of R<sub>b</sub> (communication line pull-up resistor) at that time in each mode are as follows.  
Fast mode plus: C<sub>b</sub> = 120 pF, R<sub>b</sub> = 1.1 kΩ

I<sup>2</sup>C serial transfer timing

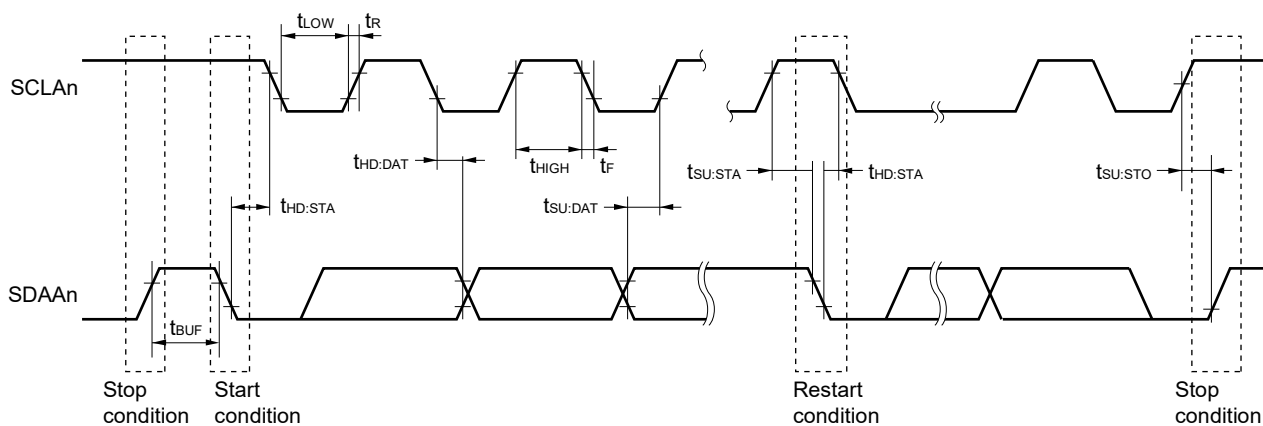

**Remark** n = 0

## 2.8 Analog Characteristics

### 2.8.1 A/D converter characteristics

A/D convertor characteristics category

Input channel \ Reference voltage	Ref. voltage(+) = $AV_{REFP}$ Ref. voltage(-) = $AV_{REFM}$	Ref. voltage(+) = $V_{DD}$ Ref. voltage(-) = $V_{SS}$	Ref. voltage(+) = $V_{BGR}$ Ref. voltage(-) = $AV_{REFM}$
ANI0	-	Refer to 2.8.1 (3)	Refer to 2.8.1 (4)
ANI1			-
ANI2, ANI3	Refer to 2.8.1 (1)	Refer to 2.8.1 (3)	Refer to 2.8.1 (4)
ANI16 to ANI19	Refer to 2.8.1 (2)		
Internal reference voltage, Temperature sensor output voltage	Refer to 2.8.1 (1)		

(1) When reference voltage (+) =  $AV_{REFP}/ANI0$  ( $ADREFP1 = 0$ ,  $ADREFP0 = 1$ ), reference voltage (-) =  $AV_{REFM}/ANI1$  ( $ADREFM = 1$ ), conversion target : ANI2, ANI3, Internal reference voltage, Temperature sensor output voltage

( $T_A = -40$  to  $+85^\circ\text{C}$ ,  $1.6\text{ V} \leq AV_{REFP} \leq V_{DD} = V_{DD\_RF} = AV_{DD\_RF} \leq 3.6\text{ V}$ ,  $V_{SS} = V_{SS\_RF} = AV_{SS\_RF} = 0\text{ V}$ , Reference voltage (+) =  $AV_{REFP}$ , Reference voltage (-) =  $AV_{REFM} = 0\text{ V}$ )

Parameter	Symbol	Conditions	MIN.	TYP.	MAX.	Unit
Resolution	RES		8		10	bit
Overall error <sup>Note 1</sup>	AINL	10-bit resolution $AV_{REFP} = V_{DD}$ <sup>Note 3</sup>	$1.8\text{ V} \leq AV_{REFP} \leq 3.6\text{ V}$	1.2	$\pm 3.5$	LSB
			$1.6\text{ V} \leq AV_{REFP} \leq 3.6\text{ V}$ <sup>Note 4</sup>	1.2	$\pm 7.0$	LSB
Conversion time	$t_{conv}$	10-bit resolution	$2.7\text{ V} \leq AV_{REFP} \leq 3.6\text{ V}$	3.1875	39	$\mu\text{s}$
			$1.8\text{ V} \leq AV_{REFP} \leq 3.6\text{ V}$	17	39	$\mu\text{s}$
			$1.6\text{ V} \leq AV_{REFP} \leq 3.6\text{ V}$	57	95	$\mu\text{s}$
Zero-scale error <sup>Note 1, 2</sup>	E <sub>ZS</sub>	10-bit resolution $AV_{REFP} = V_{DD}$ <sup>Note 3</sup>	$1.8\text{ V} \leq AV_{REFP} \leq 3.6\text{ V}$		$\pm 0.25$	%FSR
			$1.6\text{ V} \leq AV_{REFP} \leq 3.6\text{ V}$ <sup>Note 4</sup>		$\pm 0.50$	%FSR
Full-scale error <sup>Note 1, 2</sup>	E <sub>FS</sub>	10-bit resolution $AV_{REFP} = V_{DD}$ <sup>Note 3</sup>	$1.8\text{ V} \leq AV_{REFP} \leq 3.6\text{ V}$		$\pm 0.25$	%FSR
			$1.6\text{ V} \leq AV_{REFP} \leq 3.6\text{ V}$ <sup>Note 4</sup>		$\pm 0.50$	%FSR
Integral linearity error <sup>Note 1</sup>	ILE	10-bit resolution $AV_{REFP} = V_{DD}$ <sup>Note 3</sup>	$1.8\text{ V} \leq AV_{REFP} \leq 3.6\text{ V}$		$\pm 2.5$	LSB
			$1.6\text{ V} \leq AV_{REFP} \leq 3.6\text{ V}$ <sup>Note 4</sup>		$\pm 5.0$	LSB
Differential linearity error <sup>Note 1</sup>	DLE	10-bit resolution $AV_{REFP} = V_{DD}$ <sup>Note 3</sup>	$1.8\text{ V} \leq AV_{REFP} \leq 3.6\text{ V}$		$\pm 1.5$	LSB
			$1.6\text{ V} \leq AV_{REFP} \leq 3.6\text{ V}$ <sup>Note 4</sup>		$\pm 2.0$	LSB
Analog input voltage	$V_{AIN}$	ANI2, ANI3	0		$AV_{REFP}$	V
		Select internal reference voltage $2.4\text{ V} \leq V_{DD} \leq 3.6\text{ V}$ , HS (high-speed main) mode			$V_{BGR}$ <sup>Note 5</sup>	V
		Select temperature sensor output voltage $2.4\text{ V} \leq V_{DD} \leq 3.6\text{ V}$ , HS (high-speed main) mode			$V_{TMS25}$ <sup>Note 5</sup>	V

**Note 1.** Excludes quantization error ( $\pm 1/2$  LSB).

**2.** This value is indicated as a ratio (%FSR) to the full-scale value.

**3.** When  $AV_{REFP} < V_{DD}$ , MAX. value is following.

Overall error:  $\pm 1$  LSB is added to the MAX. value of  $AV_{REFP} = V_{DD}$ .

Zero-scale error / Full-scale error:  $\pm 0.05$  %FSR is added to the MAX. value of  $AV_{REFP} = V_{DD}$ .

Integral linearity error / Differential linearity error:  $\pm 0.5$  LSB is added to the MAX. value of  $AV_{REFP} = V_{DD}$ .

**4.** When the the conversion time is set to 57  $\mu\text{s}$  (min.) and 95  $\mu\text{s}$  (max.).

**5.** Refer to 2.8.2 Temperature sensor and internal reference voltage characteristics.

(2) When reference voltage (+) =  $AV_{REFP}/ANI0$  ( $ADREFP1 = 0$ ,  $ADREFP0 = 1$ ), reference voltage (-) =  $AV_{REFM}/ANI1$  ( $ADREFM = 1$ ), conversion target : ANI16 to ANI19

( $T_A = -40$  to  $+85^\circ\text{C}$ ,  $1.6\text{ V} \leq AV_{REFP} \leq V_{DD} = V_{DD\_RF} = AV_{DD\_RF} \leq 3.6\text{ V}$ ,  $V_{SS} = V_{SS\_RF} = AV_{SS\_RF} = 0\text{ V}$ , Reference voltage (+) =  $AV_{REFP}$ , Reference voltage (-) =  $AV_{REFM} = 0\text{ V}$ )

Parameter	Symbol	Conditions		MIN.	TYP.	MAX.	Unit
Resolution	RES			8		10	bit
Overall error <sup>Note 1</sup>	AINL	10-bit resolution $AV_{REFP} = V_{DD}$ <sup>Note 3</sup>	$1.8\text{ V} \leq AV_{REFP} \leq 3.6\text{ V}$		1.2	$\pm 5.0$	LSB
			$1.6\text{ V} \leq AV_{REFP} \leq 3.6\text{ V}$ <sup>Note 4</sup>		1.2	$\pm 8.5$	LSB
Conversion time	$T_{conv}$	10-bit resolution	$2.7\text{ V} \leq V_{DD} \leq 3.6\text{ V}$	3.1875		39	$\mu\text{s}$
			$1.8\text{ V} \leq V_{DD} \leq 3.6\text{ V}$		17	39	$\mu\text{s}$
			$1.6\text{ V} \leq AV_{REFP} \leq 3.6\text{ V}$		57	95	$\mu\text{s}$
Zero-scale error <sup>Note 1, 2</sup>	E <sub>ZS</sub>	10-bit resolution $AV_{REFP} = V_{DD}$ <sup>Note 3</sup>	$1.8\text{ V} \leq AV_{REFP} \leq 3.6\text{ V}$			$\pm 0.35$	%FSR
			$1.6\text{ V} \leq AV_{REFP} \leq 3.6\text{ V}$ <sup>Note 4</sup>			$\pm 0.60$	%FSR
Full-scale error <sup>Note 1, 2</sup>	E <sub>FS</sub>	10-bit resolution $AV_{REFP} = V_{DD}$ <sup>Note 3</sup>	$1.8\text{ V} \leq AV_{REFP} \leq 3.6\text{ V}$			$\pm 0.35$	%FSR
			$1.6\text{ V} \leq AV_{REFP} \leq 3.6\text{ V}$ <sup>Note 4</sup>			$\pm 0.60$	%FSR
Integral linearity error <sup>Note 1</sup>	ILE	10-bit resolution $AV_{REFP} = V_{DD}$ <sup>Note 3</sup>	$1.8\text{ V} \leq AV_{REFP} \leq 3.6\text{ V}$			$\pm 3.5$	LSB
			$1.6\text{ V} \leq AV_{REFP} \leq 3.6\text{ V}$ <sup>Note 4</sup>			$\pm 6.0$	LSB
Differential linearity error <sup>Note 1</sup>	DLE	10-bit resolution $AV_{REFP} = V_{DD}$ <sup>Note 3</sup>	$1.8\text{ V} \leq AV_{REFP} \leq 3.6\text{ V}$			$\pm 2.0$	LSB
			$1.6\text{ V} \leq AV_{REFP} \leq 3.6\text{ V}$ <sup>Note 4</sup>			$\pm 2.5$	LSB
Analog input voltage	$V_{AIN}$			0		$AV_{REFP}$ and $V_{DD}$	V

**Note 1.** Excludes quantization error ( $\pm 1/2$  LSB).

**2.** This value is indicated as a ratio (%FSR) to the full-scale value.

**3.** When  $AV_{REFP} < V_{DD}$ , MAX. value is following.

Overall error:  $\pm 4$  LSB is added to the MAX. value of  $AV_{REFP} = V_{DD}$ .

Zero-scale error / Full-scale error:  $\pm 0.2$  %FSR is added to the MAX. value of  $AV_{REFP} = V_{DD}$ .

Integral linearity error / Differential linearity error:  $\pm 2$  LSB is added to the MAX. value n of  $AV_{REFP} = V_{DD}$ .

**4.** When the the conversion time is set to 57  $\mu\text{s}$  (min.) and 95  $\mu\text{s}$  (max.).

(3) When reference voltage (+) = V<sub>DD</sub> (ADREFP1 = 0, ADREFP0 = 0), reference voltage (-) = V<sub>SS</sub> (ADREFM = 0), conversion target : ANI0 to ANI3, ANI16 to ANI19, Internal reference voltage, Temperature sensor output voltage

(T<sub>A</sub> = -40 to +85°C, 1.8 V ≤ V<sub>DD</sub> = V<sub>DD\_RF</sub> = AV<sub>DD\_RF</sub> ≤ 3.6 V, V<sub>SS</sub> = V<sub>SS\_RF</sub> = AV<sub>SS\_RF</sub> = 0 V, Reference voltage (+) = V<sub>DD</sub>, Reference voltage (-) = V<sub>SS</sub>)

Parameter	Symbol	Conditions		MIN.	TYP.	MAX.	Unit
Resolution	RES			8		10	bit
Overall error <sup>Note 1</sup>	AINL	10-bit resolution	1.8 V ≤ V <sub>DD</sub> ≤ 3.6 V		1.2	±7.0	LSB
			1.6 V ≤ V <sub>DD</sub> ≤ 3.6 V <sup>Note 3</sup>		1.2	±10.5	LSB
Conversion time	T <sub>conv</sub>	10-bit resolution conversion target : ANI0 to ANI3, ANI16 to ANI19	2.7 V ≤ V <sub>DD</sub> ≤ 3.6 V	3.1875		39	μs
			1.8 V ≤ V <sub>DD</sub> ≤ 3.6 V	17		39	μs
		1.6 V ≤ V <sub>DD</sub> ≤ 3.6 V	57		95	μs	
		10-bit resolution conversion target : Internal reference voltage, Temperature sensor output voltage (HS (high-speed main) Mode)	2.7 V ≤ V <sub>DD</sub> ≤ 3.6 V	3.5635		39	μs
			2.7 V ≤ V <sub>DD</sub> ≤ 3.6 V	17		39	μs
Zero-scale error <sup>Note 1, 2</sup>	E <sub>ZS</sub>	10-bit resolution	1.8 V ≤ V <sub>DD</sub> ≤ 3.6 V			±0.60	%FSR
			1.6 V ≤ V <sub>DD</sub> ≤ 3.6 V <sup>Note 3</sup>			±0.85	%FSR
Full-scale error <sup>Note 1, 2</sup>	E <sub>FS</sub>	10-bit resolution	1.8 V ≤ V <sub>DD</sub> ≤ 3.6 V			±0.60	%FSR
			1.6 V ≤ V <sub>DD</sub> ≤ 3.6 V <sup>Note 3</sup>			±0.85	%FSR
Integral linearity error <sup>Note 1</sup>	ILE	10-bit resolution	1.8 V ≤ V <sub>DD</sub> ≤ 3.6 V			±4.0	LSB
			1.6 V ≤ V <sub>DD</sub> ≤ 3.6 V <sup>Note 3</sup>			±6.5	LSB
Differential linearity error <sup>Note 1</sup>	DLE	10-bit resolution	1.8 V ≤ V <sub>DD</sub> ≤ 3.6 V			±2.0	LSB
			1.6 V ≤ V <sub>DD</sub> ≤ 3.6 V <sup>Note 3</sup>			±2.5	LSB
Analog input voltage	V <sub>AIN</sub>	ANI0 to ANI3, ANI16 to ANI19		0		V <sub>DD</sub>	V
		Select internal reference voltage 2.4 V ≤ V <sub>DD</sub> ≤ 3.6 V, HS (high-speed main) mode		V <sub>BGR</sub> <sup>Note 4</sup>			V
		Select temperature sensor output voltage 2.4 V ≤ V <sub>DD</sub> ≤ 3.6 V, HS (high-speed main) mode		V <sub>TMPS25</sub> <sup>Note 4</sup>			V

- Note 1.** Excludes quantization error (±1/2 LSB).
- 2.** This value is indicated as a ratio (%FSR) to the full-scale value.
- 3.** When the the conversion time is set to 57 μs (min.) and 95 μs (max.).
- 4.** Refer to **2.8.2 Temperature sensor and internal reference voltage characteristics**

(4) When reference voltage (+) = Internal reference voltage (ADREFP1 = 1, ADREFP0 = 0), reference voltage (-) = AV<sub>REFM</sub>/ANI1 (ADREFM = 1), conversion target : ANI0 to ANI3, ANI16 to ANI19

(T<sub>A</sub> = -40 to +85°C, 2.4 V ≤ V<sub>DD</sub> = V<sub>DD\_RF</sub> = AV<sub>DD\_RF</sub> ≤ 3.6 V, V<sub>SS</sub> = V<sub>SS\_RF</sub> = AV<sub>SS\_RF</sub> = 0 V, Reference voltage (+) = V<sub>BGR</sub> = Note 3, Reference voltage (-) = AV<sub>REFM</sub> Note 4 = 0 V, HS (high-speed main) mode)

Parameter	Symbol	Conditions		MIN.	TYP.	MAX.	Unit
Resolution	RES			8			bit
Conversion time	T <sub>conv</sub>	8-bit resolution	2.4 V ≤ V <sub>DD</sub> ≤ 3.6 V	17		39	μs
Zero-scale error <sup>Note 1, 2</sup>	E <sub>ZS</sub>	8-bit resolution	2.4 V ≤ V <sub>DD</sub> ≤ 3.6 V			±0.60	%FSR
Integral linearity error <sup>Note 1</sup>	ILE	8-bit resolution	2.4 V ≤ V <sub>DD</sub> ≤ 3.6 V			±2.0	LSB
Differential linearity error <sup>Note 1</sup>	DLE	8-bit resolution	2.4 V ≤ V <sub>DD</sub> ≤ 3.6 V			±1.0	LSB
Analog input voltage	V <sub>AIN</sub>			0		V <sub>BGR</sub> Note 3	V

**Note 1.** Excludes quantization error (±1/2 LSB).

**2.** This value is indicated as a ratio (%FSR) to the full-scale value.

**3.** Refer to 2.8.2 Temperature sensor and internal reference voltage characteristics.

**4.** When reference voltage (-) = V<sub>SS</sub>, MAX. value is following.

Zero-scale error: ±0.35 %FSR is added to the MAX. value of reference voltage (-) = AV<sub>REFM</sub>.

Integral linearity error: ±0.5 LSB is added to the MAX. value of reference voltage (-) = AV<sub>REFM</sub>.

Differential linearity error: ±0.2 LSB is added to the MAX. value of reference voltage (-) = AV<sub>REFM</sub>.

2.8.2 Temperature sensor and internal reference voltage characteristics

( $T_A = -40$  to  $+85^\circ\text{C}$ ,  $2.4\text{ V} \leq V_{DD} = V_{DD\_RF} = AV_{DD\_RF} \leq 3.6\text{ V}$ ,  $V_{SS} = V_{SS\_RF} = AV_{SS\_RF} = 0\text{ V}$ , HS (high-speed main) mode)

Parameter	Symbol	Conditions	MIN.	TYP.	MAX.	Unit
Temperature sensor output voltage	$V_{TMPS25}$	Setting ADS register = 80H, $T_A = +25^\circ\text{C}$		1.05		V
Internal reference voltage	$V_{BGR}$	Setting ADS register = 81H	1.38	1.45	1.5	V
Temperature coefficient	$F_{TMPS}$	Temperature sensor output voltage that depends on the temperature		-3.6		mV/ $^\circ\text{C}$
Operation stabilization wait time	$t_{AMP}$		5			$\mu\text{s}$

2.8.3 POR circuit characteristics

( $T_A = -40$  to  $+85^\circ\text{C}$ ,  $V_{SS} = V_{SS\_RF} = AV_{SS\_RF} = 0\text{ V}$ )

Parameter	Symbol	Conditions	MIN.	TYP.	MAX.	Unit
Detection voltage	$V_{POR}$	Rise time	1.47	1.51	1.55	V
	$V_{PDR}$	Fall time	1.46	1.50	1.54	V
Minimum pulse width <sup>Note</sup>	$T_{PW}$	Other than STOP/SUB_RUN/SUB_HALT	300			$\mu\text{s}$

**Note** This is the time required for the POR circuit to execute a reset operation when  $V_{DD}$  falls below  $V_{PDR}$ . When the main system clock ( $f_{MAIN}$ ) has been stopped by setting bit 0 (HIOSTOP) and bit 7 (MSTOP) of the clock operation status control register (CSC) or when the microcontroller enters STOP mode, this is the time required for the POR circuit to execute a reset operation between when  $V_{DD}$  falls below 0.7 V and when  $V_{DD}$  rises to  $V_{POR}$  or higher.

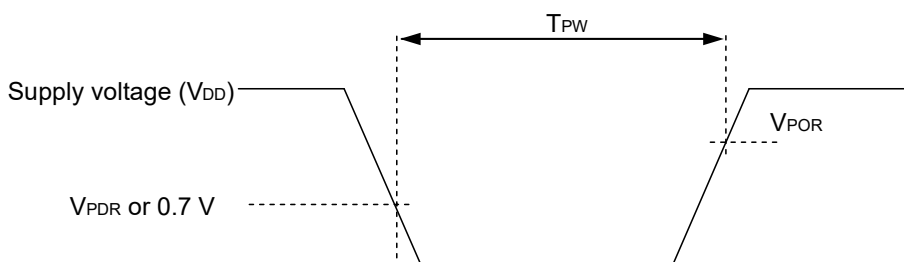

## 2.8.4 LVD circuit characteristics

## LVD Detection Voltage of Reset Mode and Interrupt Mode

(T<sub>A</sub> = -40 to +85°C, V<sub>PDR</sub> ≤ V<sub>DD</sub> = V<sub>DD\_RF</sub> = AV<sub>DD\_RF</sub> ≤ 3.6 V, V<sub>SS</sub> = V<sub>SS\_RF</sub> = AV<sub>SS\_RF</sub> = 0 V)

Parameter		Symbol	Conditions	MIN.	TYP.	MAX.	Unit
Detection voltage	Supply voltage	V <sub>LV12</sub>	Power supply rise time	3.07	3.13	3.19	V
			Power supply fall time	3	3.06	3.12	V
		V <sub>LV13</sub>	Power supply rise time	2.96	3.02	3.08	V
			Power supply fall time	2.9	2.96	3.02	V
		V <sub>LV14</sub>	Power supply rise time	2.86	2.92	2.97	V
			Power supply fall time	2.8	2.86	2.91	V
		V <sub>LV15</sub>	Power supply rise time	2.76	2.81	2.87	V
			Power supply fall time	2.7	2.75	2.81	V
		V <sub>LV16</sub>	Power supply rise time	2.66	2.71	2.76	V
			Power supply fall time	2.6	2.65	2.7	V
		V <sub>LV17</sub>	Power supply rise time	2.56	2.61	2.66	V
			Power supply fall time	2.5	2.55	2.6	V
		V <sub>LV18</sub>	Power supply rise time	2.45	2.5	2.55	V
			Power supply fall time	2.4	2.45	2.5	V
		V <sub>LV19</sub>	Power supply rise time	2.05	2.09	2.13	V
			Power supply fall time	2	2.04	2.08	V
		V <sub>LV110</sub>	Power supply rise time	1.94	1.98	2.02	V
			Power supply fall time	1.9	1.94	1.98	V
		V <sub>LV111</sub>	Power supply rise time	1.84	1.88	1.91	V
			Power supply fall time	1.8	1.84	1.87	V
		V <sub>LV112</sub>	Power supply rise time	1.74	1.77	1.81	V
			Power supply fall time	1.7	1.73	1.77	V
		V <sub>LV113</sub>	Power supply rise time	1.64	1.67	1.7	V
			Power supply fall time	1.6	1.63	1.66	V
Minimum pulse width		T <sub>LW</sub>		300			μs
Detection delay time						300	μs

**LVD Detection Voltage of Interrupt & Reset Mode**

( $T_A = -40$  to  $+85^\circ\text{C}$ ,  $1.6\text{ V} \leq V_{DD} = V_{DD\_RF} = AV_{DD\_RF} \leq 3.6\text{ V}$ ,  $V_{SS} = V_{SS\_RF} = AV_{SS\_RF} = 0\text{ V}$ )

Parameter	Symbol	Conditions	MIN.	TYP.	MAX.	Unit	
Interrupt and reset mode	V <sub>LVDA0</sub>	V <sub>POC2</sub> , V <sub>POC1</sub> , V <sub>POC0</sub> = 0, 0, 0, falling reset voltage	1.60	1.63	1.66	V	
	V <sub>LVDA1</sub>	LVIS1, LVIS0 = 1, 0	Rising release reset voltage	1.74	1.77	1.81	V
			Falling interrupt voltage	1.70	1.73	1.77	V
	V <sub>LVDA2</sub>	LVIS1, LVIS0 = 0, 1	Rising release reset voltage	1.84	1.88	1.91	V
			Falling interrupt voltage	1.8	1.84	1.87	V
	V <sub>LVDA3</sub>	LVIS1, LVIS0 = 0, 0	Rising release reset voltage	2.86	2.92	2.97	V
			Falling interrupt voltage	2.80	2.86	2.91	V
	V <sub>LVDB0</sub>	V <sub>POC2</sub> , V <sub>POC1</sub> , V <sub>POC0</sub> = 0, 0, 1, falling reset voltage	1.80	1.84	1.87	V	
	V <sub>LVDB1</sub>	LVIS1, LVIS0 = 1, 0	Rising release reset voltage	1.94	1.98	2.02	V
			Falling interrupt voltage	1.90	1.94	1.98	V
	V <sub>LVDB2</sub>	LVIS1, LVIS0 = 0, 1	Rising release reset voltage	2.05	2.09	2.13	V
			Falling interrupt voltage	2.00	2.04	2.08	V
	V <sub>LVDB3</sub>	LVIS1, LVIS0 = 0, 0	Rising release reset voltage	3.07	3.13	3.19	V
			Falling interrupt voltage	3.00	3.06	3.12	V
V <sub>LVDC0</sub>	V <sub>POC2</sub> , V <sub>POC1</sub> , V <sub>POC0</sub> = 0, 1, 0, falling reset voltage	2.40	2.45	2.50	V		
V <sub>LVDC1</sub>	LVIS1, LVIS0 = 1, 0	Rising release reset voltage	2.56	2.61	2.66	V	
		Falling interrupt voltage	2.50	2.55	2.60	V	
V <sub>LVDC2</sub>	LVIS1, LVIS0 = 0, 1	Rising release reset voltage	2.66	2.71	2.76	V	
		Falling interrupt voltage	2.60	2.65	2.70	V	
V <sub>LVDD0</sub>	V <sub>POC2</sub> , V <sub>POC1</sub> , V <sub>POC0</sub> = 0, 1, 1, falling reset voltage	2.70	2.75	2.81	V		
V <sub>LVDD1</sub>	LVIS1, LVIS0 = 1, 0	Rising release reset voltage	2.86	2.92	2.97	V	
		Falling interrupt voltage	2.80	2.86	2.91	V	
V <sub>LVDD2</sub>	LVIS1, LVIS0 = 0, 1	Rising release reset voltage	2.96	3.02	3.08	V	
		Falling interrupt voltage	2.90	2.96	3.02	V	

**2.8.5 Supply voltage rise time**

( $T_A = -40$  to  $+85^\circ\text{C}$ ,  $V_{SS} = V_{SS\_RF} = AV_{SS\_RF} = 0\text{ V}$ )

Parameter	Symbol	Conditions	MIN.	TYP.	MAX.	Unit
V <sub>DD</sub> rise slope	S <sub>VDD</sub>				54	V/ms

**Caution** Make sure to keep the internal reset state by the LVD circuit or an external reset until V<sub>DD</sub> reaches the operating voltage range shown in 2.6 AC Characteristics.



## 2.9 RF Transceiver Characteristics

### 2.9.1 RF transmission characteristics

Unless specified otherwise, the measurement is performed by our evaluation board.

( $T_A = +25^\circ\text{C}$ ,  $V_{DD} = V_{DD\_RF} = AV_{DD\_RF} = 3.0\text{ V}$ ,  $f = 2440\text{ MHz}$ ,  $V_{SS} = V_{SS\_RF} = AV_{SS\_RF} = 0\text{ V}$ )

Parameter	Symbol	Conditions		MIN.	TYP.	MAX.	Unit
RF frequency range	RF <sub>CF</sub>			2402		2480	MHz
Data rate	RF <sub>DATA</sub>				1		Mbps
Maximum transmitted output power	RF <sub>POWER</sub>	RF output pin	RF low power mode	-18	-15	-12	dBm
			RF normal mode	-3	0	3	dBm
			RF high performance mode	-3	0	3	dBm
Transmitted output power setting	RF <sub>TXPOW</sub>	0, -1, -2, -7, -10, -15 dBm		-15		0	dBm
Spurious radiation	RF <sub>TXSP</sub>	30 to 88 MHz			-76	-55	dBm
		88 to 216 MHz			-76	-52	dBm
		216 to 960 MHz			-74	-49	dBm
		960 to 1000 MHz			-74	-30	dBm
		1 to 12.75 GHz			-42	-41	dBm
		1.8 to 1.9 GHz			-73	-47	dBm
		5.15 to 5.3 GHz			-71	-47	dBm
Harmonics	RF <sub>TXHC1</sub>	2 <sup>nd</sup> Harmonics			-52	-41	dBm
	RF <sub>TXHC2</sub>	3 <sup>rd</sup> Harmonics			-51	-41	dBm
Frequency tolerance	RF <sub>TXFERR</sub>			-30		+30	ppm
Impedance	RF <sub>Z1</sub>				50+j0		Ω

**Caution** Install EMI countermeasures as required to prevent EMI effects of the RF transmission characteristics.

### 2.9.2 RF reception characteristics

Unless specified otherwise, the measurement is performed by our evaluation board.

( $T_A = +25^\circ\text{C}$ ,  $V_{DD} = V_{DD\_RF} = AV_{DD\_RF} = 3.0\text{ V}$ ,  $f = 2440\text{ MHz}$ ,  $V_{SS} = V_{SS\_RF} = AV_{SS\_RF} = 0\text{ V}$ )

Parameter	Symbol	Conditions		MIN.	TYP.	MAX.	Unit
RF input frequency	RF <sub>RXFRIN</sub>			2402		2480	MHz
Maximum input level	RF <sub>LEVEL</sub>	PER ≤ 30.8% RF input pin	RF low power mode	-10	0	-	dBm
			RF normal mode	-10	1	-	dBm
			RF high performance mode	-10	1	-	dBm
Receiver sensitivity	RF <sub>STY</sub>	PER ≤ 30.8%	RF low power mode	-	-60	-50	dBm
			RF normal mode	-	-90	-70	dBm
			RF high performance mode	-	-92	-70	dBm
Secondary radiation	RF <sub>RXSP</sub>		30 MHz to 1 GHz	-	-72	-57	dBm/ 100 kHz
			1 GHz to 12 GHz	-	-57	-54	dBm/ 100 kHz
Common channel rejection ratio	RF <sub>CCR</sub>	PER ≤ 30.8%, Prf = -67dBm		-21	-12	-	dB
Adjacent channel rejection ratio	RF <sub>ADCR</sub>	PER ≤ 30.8% Prf = -67 dBm	±1 MHz	-15	-5	-	dB
			±2 MHz	17	29	-	dB
			±3 MHz	27	34	-	dB
Blocking	RF <sub>BLK</sub>	PER ≤ 30.8% Prf = -67 dBm	30 MHz - 2000 MHz	-30	-13	-	dB
			2000 MHz to 2399 MHz	-35	-30	-	dBm
			2484 MHz to 3000 MHz	-35	-30	-	dBm
			> 3000 MHz	-30	-17	-	dBm
Frequency tolerance	RF <sub>RXFERR</sub>	PER ≤ 30.8%		-250		+250	kHz
RSSI accuracy	RF <sub>RSSIS</sub>	$T_A = +25^\circ\text{C}$ , $-70\text{ dBm} \leq \text{Prf} \leq -10\text{ dBm}$		-4	0	4	dB

2.9.3 Performance mapping for typical RF (Reference)

(1) Peak Current during RF Transmission

Unless specified otherwise, the measurement is performed by our evaluation board.  
 Current consumption is not including MCU unit.

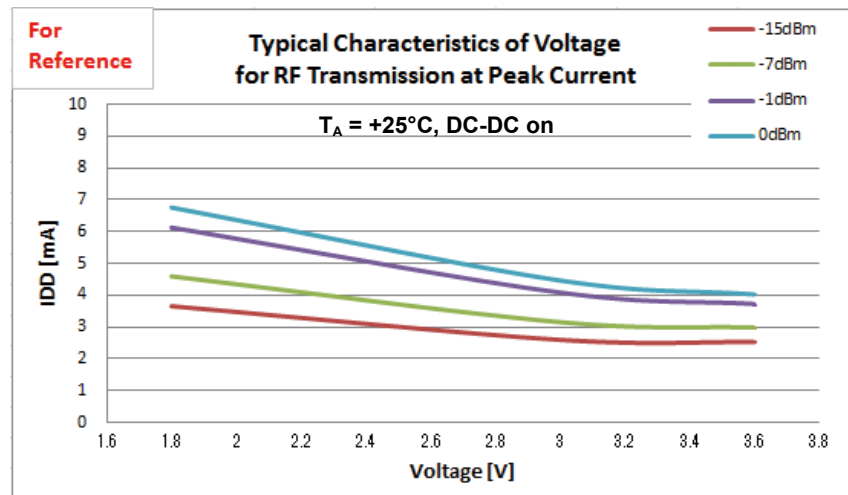
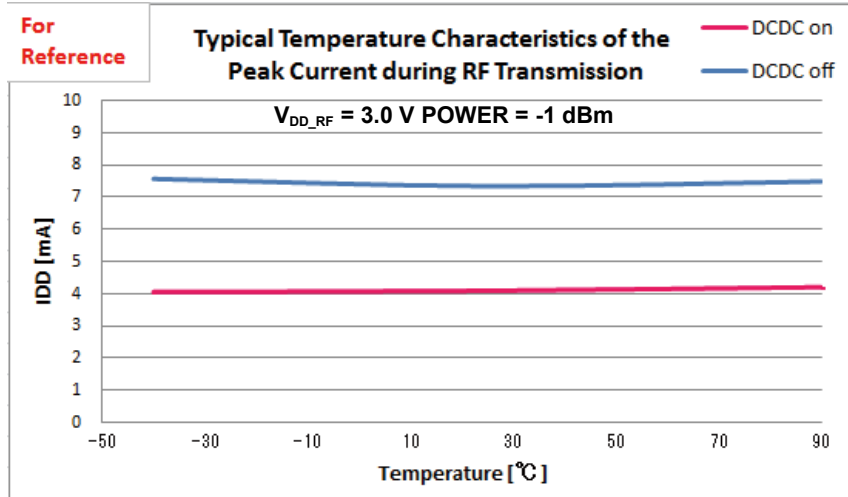

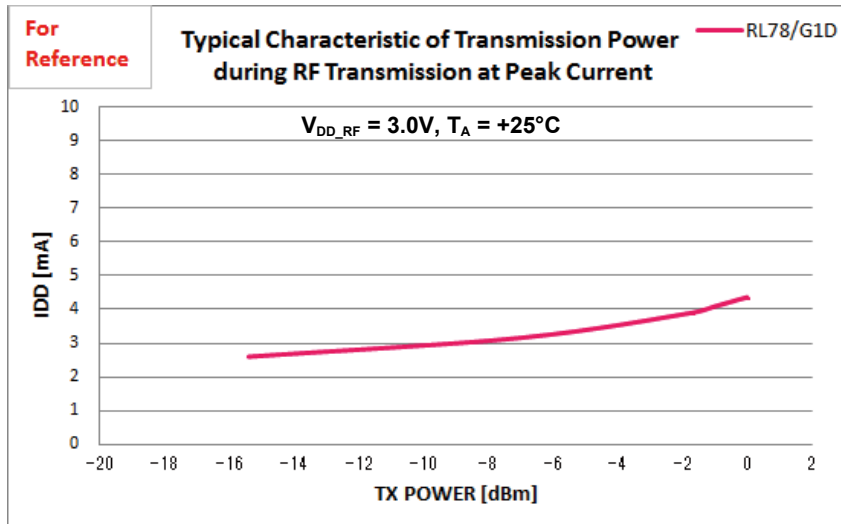

**(2) Peak Current during RF Reception**

Unless specified otherwise, the measurement is performed by our evaluation board.  
 Current consumption is not including MCU unit.

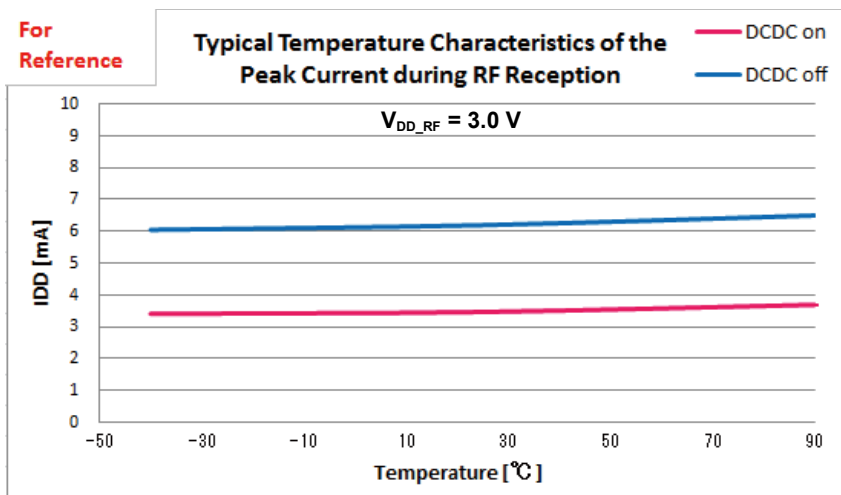

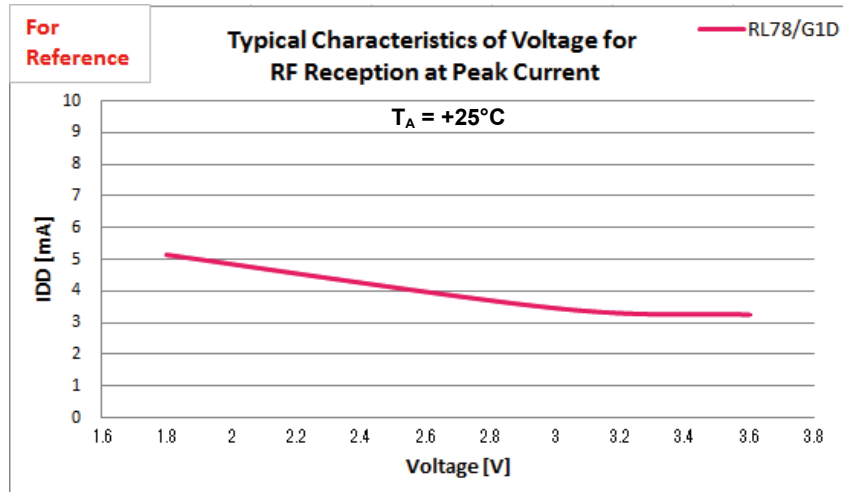

**(3) RF Output Power during Transmission**

Unless specified otherwise, the measurement is performed by our evaluation board.

Current consumption is not including MCU unit.

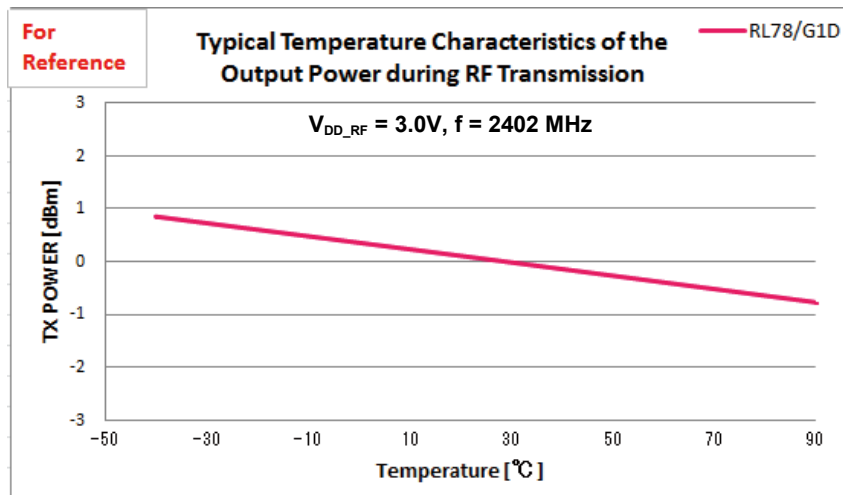

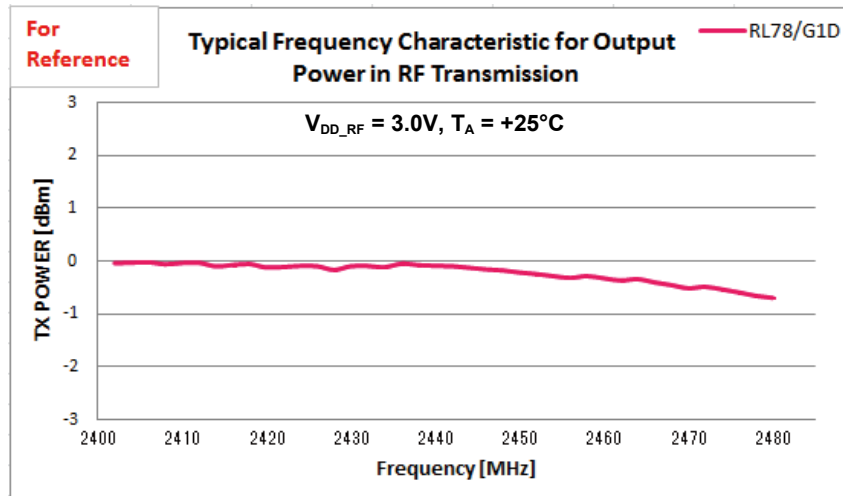
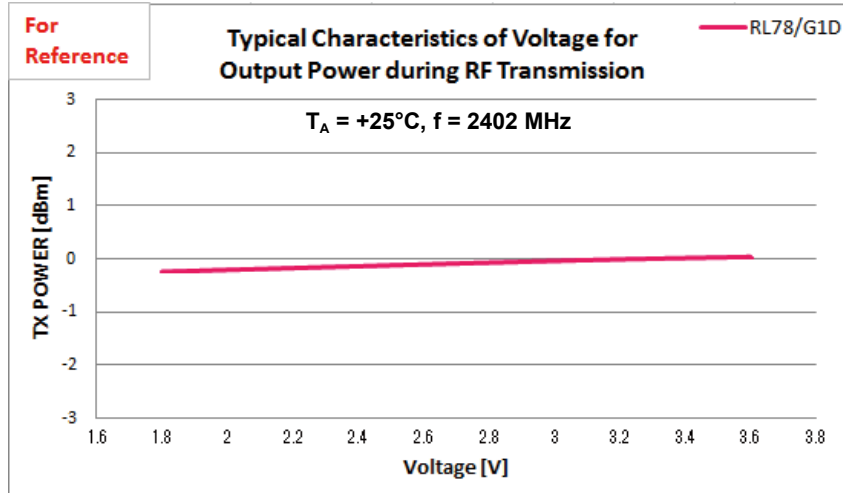

**(4) RF Reception Sensitivity**

Unless specified otherwise, the measurement is performed by our evaluation board.  
 Current consumption is not including MCU unit.

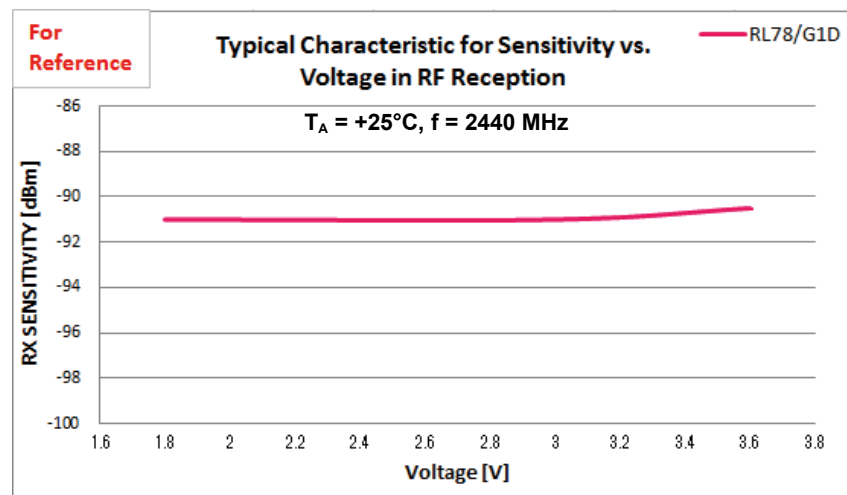
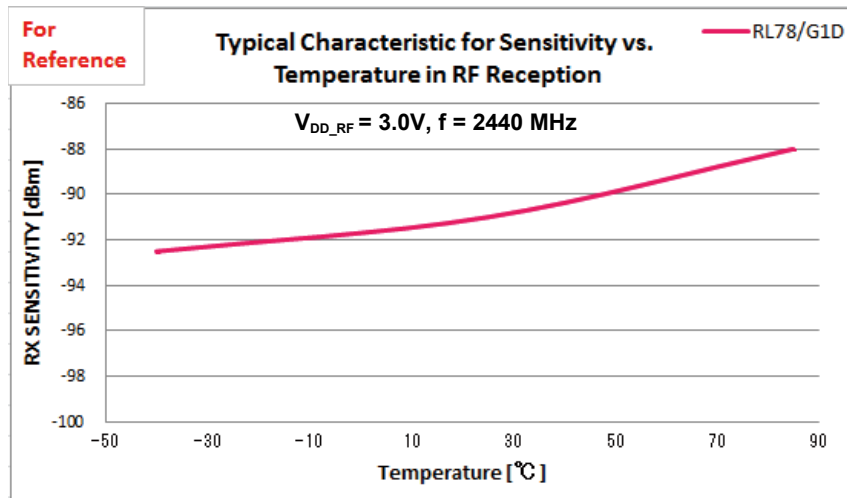

### 2.10 RAM Data Retention Characteristics

( $T_A = -40$  to  $+85^\circ\text{C}$ )

Parameter	Symbol	Conditions	MIN.	TYP.	MAX.	Unit
Data retention supply voltage	V <sub>DDDR</sub>		1.46 <sup>Note</sup>		3.6	V

**Note** The value depends on the POR detection voltage. When the voltage drops, the data is retained before a POR reset is effected, but data is not retained when a POR reset is effected.

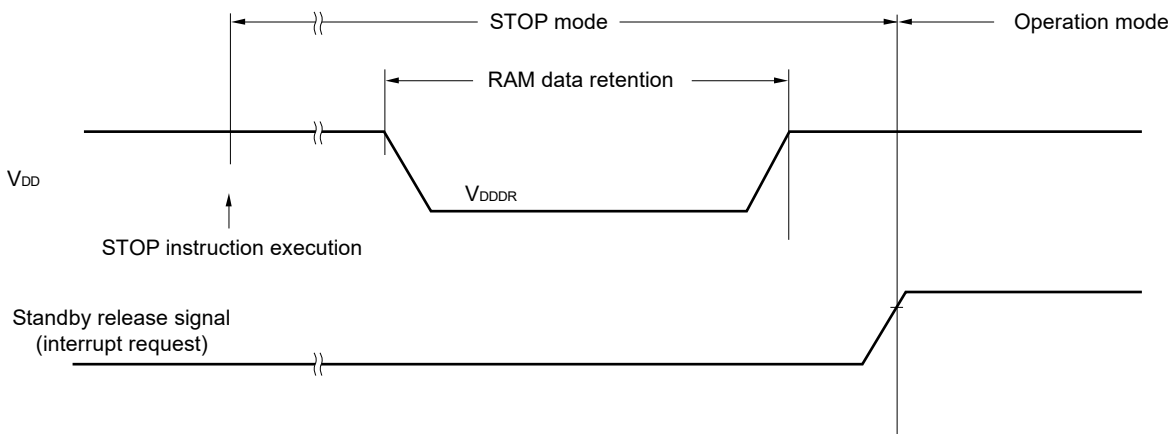

### 2.11 Flash Memory Programming Characteristics

( $T_A = -40$  to  $+85^\circ\text{C}$ ,  $1.8\text{ V} \leq V_{DD} = V_{DD\_RF} = AV_{DD\_RF} \leq 3.6\text{ V}$ ,  $V_{SS} = V_{SS\_RF} = AV_{SS\_RF} = 0\text{ V}$ )

Parameter	Symbol	Conditions	MIN.	TYP.	MAX.	Unit
CPU/peripheral hardware clock frequency	f <sub>CLK</sub>	$1.8\text{ V} \leq V_{DD} \leq 3.6\text{ V}$	1		32	MHz
Number of code flash rewrites <small>Note 1, 2, 3</small>	C <sub>enwr</sub>	Retained for 20 years, $T_A = 85^\circ\text{C}$	1,000			Times
Number of data flash rewrites <small>Note 1, 2, 3</small>		Retained for 1 year, $T_A = 25^\circ\text{C}$		1,000,000		Times
		Retained for 5 years, $T_A = 85^\circ\text{C}$	100,000			Times
		Retained for 20 years, $T_A = 85^\circ\text{C}$	10,000			Times

**Note 1.** 1 erase + 1 write after the erase is regarded as 1 rewrite. The retaining years are until next rewrite after the rewrite.

**2.** When using flash memory programmer and Renesas Electronics self programming library

**3.** This shows the flash memory characteristics. This is a result obtained from Renesas Electronics reliability test.

### 2.12 Special Flash Memory Programming Communication (UART)

( $T_A = -40$  to  $+85^\circ\text{C}$ ,  $1.8\text{ V} \leq V_{DD} = V_{DD\_RF} = AV_{DD\_RF} \leq 3.6\text{ V}$ ,  $V_{SS} = V_{SS\_RF} = AV_{SS\_RF} = 0\text{ V}$ )

Parameter	Symbol	Conditions	MIN.	TYP.	MAX.	Unit
Transfer rate		When programming of flash memory	115,200		1,000,000	bps



2.13 Timing of Entry to Flash Memory Programming Modes

( $T_A = -40$  to  $+85^\circ\text{C}$ ,  $1.8\text{ V} \leq V_{DD} = V_{DD\_RF} = AV_{DD\_RF} \leq 3.6\text{ V}$ ,  $V_{SS} = V_{SS\_RF} = AV_{SS\_RF} = 0\text{ V}$ )

Parameter	Symbol	Conditions	MIN.	MAX.	Unit
Time to complete the communication for the initial setting after the external reset is released	$t_{SUIINIT}$	POR and LVD reset must be released before the external reset is released.		100	ms
Time to release the external reset after the TOOL0 pin is set to the low level	$t_{SU}$	POR and LVD reset must be released before the external reset is released.	10		$\mu\text{s}$
Time to hold the TOOL0 pin at the low level after the external reset is released (excluding the processing time of the firmware to control the flash memory)	$t_{HD}$	POR and LVD reset must be released before the external reset is released.	1		ms

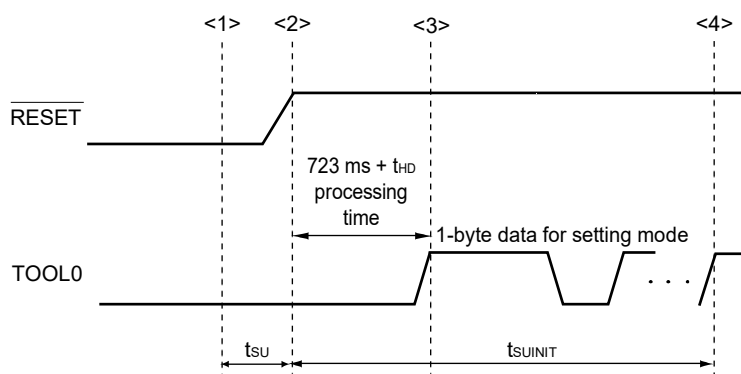

- <1> The low level is input to the TOOL0 pin.
- <2> The external reset is released (POR and LVD reset must be released before the external reset is released.).
- <3> The TOOL0 pin is set to the high level.
- <4> Setting of the flash memory programming mode by UART reception and complete the baud rate setting.

**Remark**  $t_{SUIINIT}$ : Communication for the initial setting must be completed within 100 ms after the external reset is released during this period.

$t_{SU}$ : Time to release the external reset after the TOOL0 pin is set to the low level

$t_{HD}$ : Time to hold the TOOL0 pin at the low level after the external reset is released (excluding the processing time of the firmware to control the flash memory)

### 3. PACKAGE DRAWINGS

#### 3.1 48-pin plastic WQFN (6 × 6)

JEITA Package Code	RENESAS Code	Previous Code	MASS (Typ) [g]
P-HWQFN48-6x6-0.40	PWQN0048LB-A	-	0.07

Unit: mm

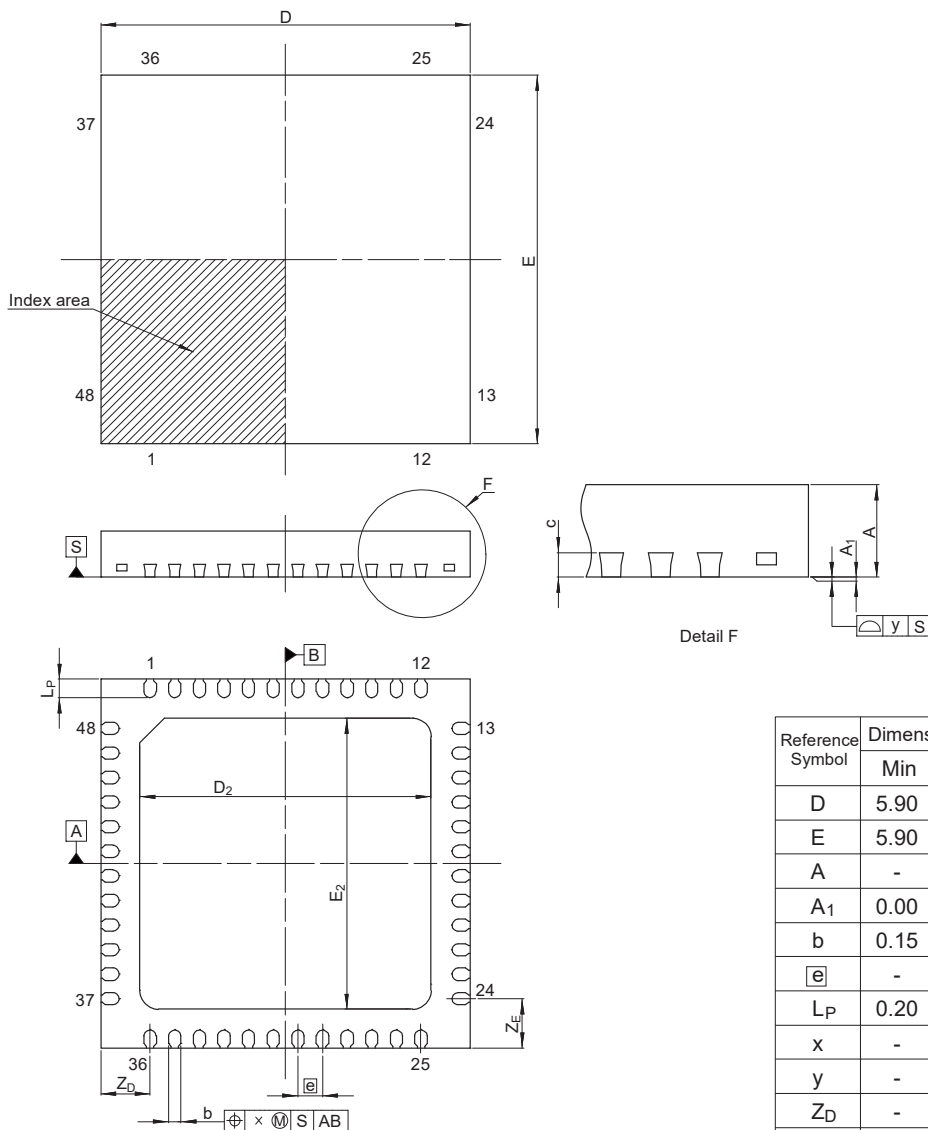

Reference Symbol	Dimensions in millimeters		
	Min	Nom	Max
D	5.90	6.00	6.10
E	5.90	6.00	6.10
A	-	-	0.80
A <sub>1</sub>	0.00	-	-
b	0.15	0.20	0.25
ⓔ	-	0.40	-
L <sub>P</sub>	0.20	0.30	0.40
x	-	-	0.05
y	-	-	0.05
Z <sub>D</sub>	-	0.80	-
Z <sub>E</sub>	-	0.80	-
c	-	0.20	-
D <sub>2</sub>	-	4.73	-
E <sub>2</sub>	-	4.73	-

© 2015 Renesas Electronics Corporation. All rights reserved.

<b>Revision History</b>	<b>RL78/G1D Data Sheet</b>
-------------------------	----------------------------

Rev.	Date	Description	
		Page	Summary
1.00	Apr 24, 2015	-	First Edition issued
1.10	Sep 25, 2015	p.1	Change of description in 1.1 Features
		p.7, 9	Change of 1.6 Outline of Functions
		p.14	Change of description in 2.3.2 On-chip oscillator characteristics
		p.19	Change of description in 2.5. Current Consumption
		p.23	Addition of specification to 2.5.1(3) Current for each peripheral circuit
		p.65	Change of description in 2.9.1 RF transmission characteristics
		p.66	Change of description in 2.9.2 RF reception characteristics
		p.67 to 71	Change of description in 30.9.3 Performance mapping for typical RF (Reference)
1.20	Dec 16, 2016	p.4	Change of pin name in 1.3 Pin Configuration (Top View)
		p.58	Change of pin names in 2.8 Analog Characteristics (1)
		p.60	Change of pin name in 2.8 Analog Characteristics (3)
1.30	Feb 23, 2018	p.1, 7	Change of Bluetooth version
		p.1	Identification of CPU core subcode
		p.6	Change of 1.5 Block Diagram
		p.55 to 57	Change of Note 2

All trademarks and registered trademarks are the property of their respective owners.

Bluetooth is a trademark of Bluetooth SIG, Inc. U.S.A.

EEPROM is a trademark of Renesas Electronics Corporation.

SuperFlash is a registered trademark of Silicon Storage Technology, Inc. in several countries including the United States and Japan.

Caution: This product uses SuperFlash® technology licensed from Silicon Storage Technology, Inc.
--

## NOTES FOR CMOS DEVICES

- (1) **VOLTAGE APPLICATION WAVEFORM AT INPUT PIN:** Waveform distortion due to input noise or a reflected wave may cause malfunction. If the input of the CMOS device stays in the area between VIL (MAX) and VIH (MIN) due to noise, etc., the device may malfunction. Take care to prevent chattering noise from entering the device when the input level is fixed, and also in the transition period when the input level passes through the area between VIL (MAX) and VIH (MIN).
- (2) **HANDLING OF UNUSED INPUT PINS:** Unconnected CMOS device inputs can be cause of malfunction. If an input pin is unconnected, it is possible that an internal input level may be generated due to noise, etc., causing malfunction. CMOS devices behave differently than Bipolar or NMOS devices. Input levels of CMOS devices must be fixed high or low by using pull-up or pull-down circuitry. Each unused pin should be connected to VDD or GND via a resistor if there is a possibility that it will be an output pin. All handling related to unused pins must be judged separately for each device and according to related specifications governing the device.
- (3) **PRECAUTION AGAINST ESD:** A strong electric field, when exposed to a MOS device, can cause destruction of the gate oxide and ultimately degrade the device operation. Steps must be taken to stop generation of static electricity as much as possible, and quickly dissipate it when it has occurred. Environmental control must be adequate. When it is dry, a humidifier should be used. It is recommended to avoid using insulators that easily build up static electricity. Semiconductor devices must be stored and transported in an anti-static container, static shielding bag or conductive material. All test and measurement tools including work benches and floors should be grounded. The operator should be grounded using a wrist strap. Semiconductor devices must not be touched with bare hands. Similar precautions need to be taken for PW boards with mounted semiconductor devices.
- (4) **STATUS BEFORE INITIALIZATION:** Power-on does not necessarily define the initial status of a MOS device. Immediately after the power source is turned ON, devices with reset functions have not yet been initialized. Hence, power-on does not guarantee output pin levels, I/O settings or contents of registers. A device is not initialized until the reset signal is received. A reset operation must be executed immediately after power-on for devices with reset functions.
- (5) **POWER ON/OFF SEQUENCE:** In the case of a device that uses different power supplies for the internal operation and external interface, as a rule, switch on the external power supply after switching on the internal power supply. When switching the power supply off, as a rule, switch off the external power supply and then the internal power supply. Use of the reverse power on/off sequences may result in the application of an overvoltage to the internal elements of the device, causing malfunction and degradation of internal elements due to the passage of an abnormal current. The correct power on/off sequence must be judged separately for each device and according to related specifications governing the device.
- (6) **INPUT OF SIGNAL DURING POWER OFF STATE :** Do not input signals or an I/O pull-up power supply while the device is not powered. The current injection that results from input of such a signal or I/O pull-up power supply may cause malfunction and the abnormal current that passes in the device at this time may cause degradation of internal elements. Input of signals during the power off state must be judged separately for each device and according to related specifications governing the device.

## Notice

1. Descriptions of circuits, software and other related information in this document are provided only to illustrate the operation of semiconductor products and application examples. You are fully responsible for the incorporation or any other use of the circuits, software, and information in the design of your product or system. Renesas Electronics disclaims any and all liability for any losses and damages incurred by you or third parties arising from the use of these circuits, software, or information.
2. Renesas Electronics hereby expressly disclaims any warranties against and liability for infringement or any other claims involving patents, copyrights, or other intellectual property rights of third parties, by or arising from the use of Renesas Electronics products or technical information described in this document, including but not limited to, the product data, drawings, charts, programs, algorithms, and application examples.
3. No license, express, implied or otherwise, is granted hereby under any patents, copyrights or other intellectual property rights of Renesas Electronics or others.
4. You shall not alter, modify, copy, or reverse engineer any Renesas Electronics product, whether in whole or in part. Renesas Electronics disclaims any and all liability for any losses or damages incurred by you or third parties arising from such alteration, modification, copying or reverse engineering.
5. Renesas Electronics products are classified according to the following two quality grades: "Standard" and "High Quality". The intended applications for each Renesas Electronics product depends on the product's quality grade, as indicated below.  
"Standard": Computers; office equipment; communications equipment; test and measurement equipment; audio and visual equipment; home electronic appliances; machine tools; personal electronic equipment; industrial robots; etc.  
"High Quality": Transportation equipment (automobiles, trains, ships, etc.); traffic control (traffic lights); large-scale communication equipment; key financial terminal systems; safety control equipment; etc.  
Unless expressly designated as a high reliability product or a product for harsh environments in a Renesas Electronics data sheet or other Renesas Electronics document, Renesas Electronics products are not intended or authorized for use in products or systems that may pose a direct threat to human life or bodily injury (artificial life support devices or systems; surgical implantations; etc.), or may cause serious property damage (space system; undersea repeaters; nuclear power control systems; aircraft control systems; key plant systems; military equipment; etc.). Renesas Electronics disclaims any and all liability for any damages or losses incurred by you or any third parties arising from the use of any Renesas Electronics product that is inconsistent with any Renesas Electronics data sheet, user's manual or other Renesas Electronics document.
6. When using Renesas Electronics products, refer to the latest product information (data sheets, user's manuals, application notes, "General Notes for Handling and Using Semiconductor Devices" in the reliability handbook, etc.), and ensure that usage conditions are within the ranges specified by Renesas Electronics with respect to maximum ratings, operating power supply voltage range, heat dissipation characteristics, installation, etc. Renesas Electronics disclaims any and all liability for any malfunctions, failure or accident arising out of the use of Renesas Electronics products outside of such specified ranges.
7. Although Renesas Electronics endeavors to improve the quality and reliability of Renesas Electronics products, semiconductor products have specific characteristics, such as the occurrence of failure at a certain rate and malfunctions under certain use conditions. Unless designated as a high reliability product or a product for harsh environments in a Renesas Electronics data sheet or other Renesas Electronics document, Renesas Electronics products are not subject to radiation resistance design. You are responsible for implementing safety measures to guard against the possibility of bodily injury, injury or damage caused by fire, and/or danger to the public in the event of a failure or malfunction of Renesas Electronics products, such as safety design for hardware and software, including but not limited to redundancy, fire control and malfunction prevention, appropriate treatment for aging degradation or any other appropriate measures. Because the evaluation of microcomputer software alone is very difficult and impractical, you are responsible for evaluating the safety of the final products or systems manufactured by you.
8. Please contact a Renesas Electronics sales office for details as to environmental matters such as the environmental compatibility of each Renesas Electronics product. You are responsible for carefully and sufficiently investigating applicable laws and regulations that regulate the inclusion or use of controlled substances, including without limitation, the EU RoHS Directive, and using Renesas Electronics products in compliance with all these applicable laws and regulations. Renesas Electronics disclaims any and all liability for damages or losses occurring as a result of your noncompliance with applicable laws and regulations.
9. Renesas Electronics products and technologies shall not be used for or incorporated into any products or systems whose manufacture, use, or sale is prohibited under any applicable domestic or foreign laws or regulations. You shall comply with any applicable export control laws and regulations promulgated and administered by the governments of any countries asserting jurisdiction over the parties or transactions.
10. It is the responsibility of the buyer or distributor of Renesas Electronics products, or any other party who distributes, disposes of, or otherwise sells or transfers the product to a third party, to notify such third party in advance of the contents and conditions set forth in this document.
11. This document shall not be reprinted, reproduced or duplicated in any form, in whole or in part, without prior written consent of Renesas Electronics.
12. Please contact a Renesas Electronics sales office if you have any questions regarding the information contained in this document or Renesas Electronics products.  
(Note 1) "Renesas Electronics" as used in this document means Renesas Electronics Corporation and also includes its directly or indirectly controlled subsidiaries.  
(Note 2) "Renesas Electronics product(s)" means any product developed or manufactured by or for Renesas Electronics.

(Rev.4.0-1 November 2017)



### SALES OFFICES

Renesas Electronics Corporation

<http://www.renesas.com>

Refer to "<http://www.renesas.com/>" for the latest and detailed information.

#### Renesas Electronics America Inc.

1001 Murphy Ranch Road, Milpitas, CA 95035, U.S.A.  
Tel: +1-408-432-8888, Fax: +1-408-434-5351

#### Renesas Electronics Canada Limited

9251 Yonge Street, Suite 8309 Richmond Hill, Ontario Canada L4C 9T3  
Tel: +1-905-237-2004

#### Renesas Electronics Europe Limited

Dukes Meadow, Millboard Road, Bourne End, Buckinghamshire, SL8 5FH, U.K  
Tel: +44-1628-651-700, Fax: +44-1628-651-804

#### Renesas Electronics Europe GmbH

Arcadiastrasse 10, 40472 Düsseldorf, Germany  
Tel: +49-211-6503-0, Fax: +49-211-6503-1327

#### Renesas Electronics (China) Co., Ltd.

Room 1709 Quantum Plaza, No.27 ZhichunLu, Haidian District, Beijing, 100191 P. R. China  
Tel: +86-10-8235-1155, Fax: +86-10-8235-7679

#### Renesas Electronics (Shanghai) Co., Ltd.

Unit 301, Tower A, Central Towers, 555 Langao Road, Putuo District, Shanghai, 200333 P. R. China  
Tel: +86-21-2226-0888, Fax: +86-21-2226-0999

#### Renesas Electronics Hong Kong Limited

Unit 1601-1611, 16/F., Tower 2, Grand Century Place, 193 Prince Edward Road West, Mongkok, Kowloon, Hong Kong  
Tel: +852-2265-6688, Fax: +852 2886-9022

#### Renesas Electronics Taiwan Co., Ltd.

13F, No. 363, Fu Shing North Road, Taipei 10543, Taiwan  
Tel: +886-2-8175-9600, Fax: +886 2-8175-9670

#### Renesas Electronics Singapore Pte. Ltd.

80 Bendemeer Road, Unit #06-02 Hyflux Innovation Centre, Singapore 339949  
Tel: +65-6213-0200, Fax: +65-6213-0300

#### Renesas Electronics Malaysia Sdn.Bhd.

Unit 1207, Block B, Menara Amcorp, Amcorp Trade Centre, No. 18, Jln Persiaran Barat, 46050 Petaling Jaya, Selangor Darul Ehsan, Malaysia  
Tel: +60-3-7955-9390, Fax: +60-3-7955-9510

#### Renesas Electronics India Pvt. Ltd.

No.777C, 100 Feet Road, HAL 2nd Stage, Indiranagar, Bangalore 560 038, India  
Tel: +91-80-67208700, Fax: +91-80-67208777

#### Renesas Electronics Korea Co., Ltd.

17F, KAMCO Yangjae Tower, 262, Gangnam-daero, Gangnam-gu, Seoul, 06265 Korea  
Tel: +82-2-558-3737, Fax: +82-2-558-5338

## X-ON Electronics

Largest Supplier of Electrical and Electronic Components

*Click to view similar products for [16-bit Microcontrollers - MCU category](#):*

*Click to view products by [Renesas manufacturer](#):*

Other Similar products are found below :

[M30302FCFP#U3](#) [MB90F036APMC-GSE1](#) [MB90F428GCPFR-GSE1](#) [MB96F683RBPMC-GSAE1](#) [R5F10MMGDFB#30](#)  
[R5F111PGGFB#30](#) [R5F117BCGNA#20](#) [DF3026XBL25V](#) [DF36014GFTV](#) [DF36014GFXV](#) [DF36034GFPV](#) [R5F11B7EANA#U0](#)  
[R5F21172DSP#U0](#) [MB90092PF-G-BNDE1](#) [MB90F335APMC1-G-SPE1](#) [MB90F345CAPFR-GSE1](#) [MB90F568PMCR-GE1](#)  
[MB96F395RSAPMC-GSE2](#) [DF36024GFXV](#) [UPD78F1018F1-BA4-A](#) [MB96F018RBPMC-GSE1](#) [MB90F867ASPFR-GE1](#)  
[M30290FCHP#U3A](#) [DF2239FA20IV](#) [R5F117BCGFP#30](#) [LC88F58B0AU-SQFPH](#) [MB90F548GPF-GE1](#) [MB90214PF-GT-310-BND-AE1](#)  
[MB90F342CESPQC-GSE2](#) [MB90F428GAPF-GSE1](#) [ML62Q504H-NNNTBWBX](#) [S912ZVH128F2VLL](#) [UPD78F1500AGK-GAK-AX](#)  
[HD64F3337SF16V](#) [MB90F428GCPF-GSE1](#) [MB90F342ESPMC-G-JNE1](#) [MB90022PF-GS-358E1](#) [MB96F395RWAPMC-GSE2](#)  
[MB96395RSAPMC-GS-110E2](#) [MB90F883CSPMC-GE1](#) [S912ZVHY64F1CLL](#) [S912ZVHY64F1VLQ](#) [ST10F280](#) [MB96F338RSAPMCR-](#)  
[GK5E2](#) [CY90096PF-G-002-BND-ERE1](#) [ML62Q1569-NNNGAZ0AX](#) [ML62Q1739-NNNGAZ0AX](#) [ML62Q1749-NNNGAZ0AX](#)  
[ML62Q1579-NNNGAZ0AX](#) [ML62Q1559-NNNGAZ0AX](#)