

## RAA210870

Pin-Configurable 70A DC/DC Power Module with PMBus Interface

FN9345  
Rev.1.00  
Oct 23, 2018

The [RAA210870](#) is a pin-strap configurable 70A step-down PMBus-compliant DC/DC power supply module that integrates a digital PWM controller, synchronous MOSFETs, power inductor, and passive components. Only input and output capacitors are needed to finish the design. Because of its thermally enhanced HDA packaging technology, the module can deliver up to 70A of continuous output current without the need for airflow or additional heat sinking. The RAA210870 simplifies configuration and control of Renesas [digital power technology](#) while offering an upgrade path to full PMBus configuration through the pin-compatible ISL8273M.

Operating over an input voltage range of 4.5V to 14V, the RAA210870 offers adjustable output voltages down to 0.6V and achieves up to 93% conversion efficiencies. A unique ChargeMode™ control architecture provides a single clock cycle response to an output load step and can support switching frequencies up to 1MHz. The power module integrates all power and most passive components and requires only a few external components to operate. A set of external resistors allows the user to easily configure the device for standard operation. A standard PMBus interface addresses fault management, in addition to real-time full telemetry and point-of-load monitoring.

A fully customizable voltage, current, and temperature protection scheme ensures safe operation for the RAA210870 under abnormal operating conditions. The device is also supported by the PowerNavigator™ software, a full digital power train development environment.

The RAA210870 is available in a low profile compact 18mmx23mmx7.5mm fully encapsulated thermally enhanced HDA package.

### Applications

- Server, telecommunications, storage, and data communications
- Industrial/ATE and networking equipment
- General purpose power for ASIC, FPGA, DSP, and memory

### Features

- 70A single channel output current
  - 4.5V to 14V single rail input voltage
  - Up to 93% efficiency
- Programmable output voltage
  - 0.6V to 2.5V output voltage settings
  - ±1.2% accuracy over line, load, and temperature
- ChargeMode control loop architecture
  - 296kHz to 1.06MHz fixed switching frequency operations
  - No compensation required
  - Fast single clock cycle transient response
- PMBus interface and/or pin-strap mode
  - Programmable through PMBus
  - Pin-strap mode for standard settings
  - Real-time telemetry for  $V_{IN}$ ,  $V_{OUT}$ ,  $I_{OUT}$ , temperature, duty cycle, and  $f_{SW}$
- Complete over/undervoltage, current, and temperature protections with fault logging
- [PowerNavigator](#) supported
- Thermally enhanced 18mmx23mmx7.5mm HDA package

### Related Literature

For a full list of related documents, visit our website

- [RAA210870](#) product page

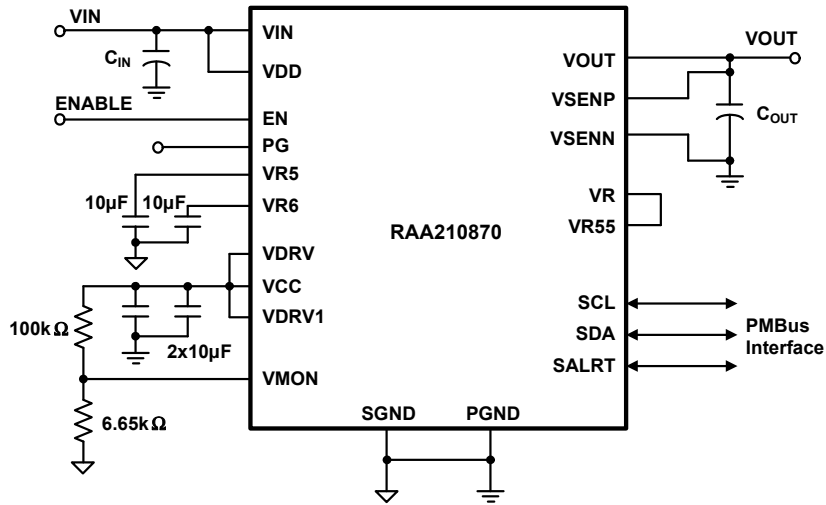

Note: Figure 1 represents a typical implementation of the RAA210870. For PMBus operation, it is recommended to tie the enable pin (EN) to SGND.

Figure 1. 70A Application Circuit

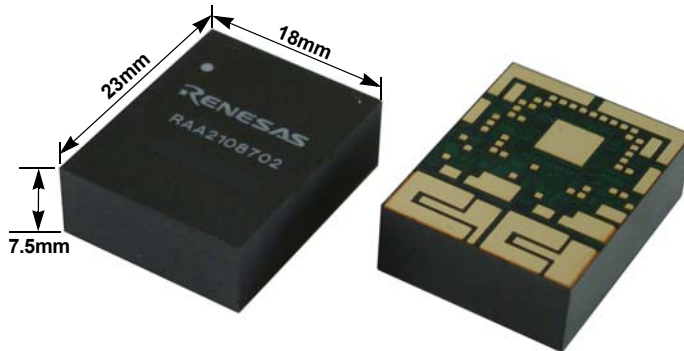

Figure 2. A Small Package for High Power Density

## Table of Contents

<b>1. Overview</b>	<b>5</b>
1.1 Typical Application Circuit - Single Module	5
1.2 RAA210870 Internal Block Diagram	8
1.3 Ordering Information	9
1.4 Pin Configuration	10
1.5 Pin Descriptions	11
<b>2. Specifications</b>	<b>13</b>
2.1 Absolute Maximum Ratings	13
2.2 Thermal Information	13
2.3 Recommended Operating Conditions	14
2.4 Electrical Specifications	14
<b>3. Typical Performance Curves</b>	<b>17</b>
3.1 Efficiency Performance	17
3.2 Transient Response Performance	18
3.3 Derating Curves	19
<b>4. Functional Description</b>	<b>20</b>
4.1 SMBus Communications	20
4.2 Output Voltage Selection	20
4.3 Soft-Start, Stop Delay, and Ramp Times	22
4.4 Input Undervoltage Lockout (UVLO)	23
4.5 Power-Good	23
4.6 Switching Frequency and PLL	23
4.7 Loop Compensation	24
4.8 SMBus Module Address Selection	25
4.9 Output Overvoltage Protection	26
4.10 Output Prebias Protection	26
4.11 Output Overcurrent Protection	27
4.12 Thermal Overload Protection	27
4.13 Phase Spreading	28
4.14 Monitoring with SMBus	29
4.15 Snapshot Parameter Capture	29
<b>5. Layout Guide</b>	<b>30</b>
5.1 Thermal Considerations	31
5.2 Package Description	31
5.3 PCB Layout Pattern Design	31
5.4 Thermal Vias	31
5.5 Stencil Pattern Design	31
5.6 Reflow Parameters	31

<b>6.</b>	<b>PMBus Command Summary</b> .....	<b>33</b>
6.1	PMBus Data Formats .....	35
6.2	PMBus Use Guidelines .....	35
<b>7.</b>	<b>PMBus Commands Description</b> .....	<b>36</b>
<b>8.</b>	<b>Revision History</b> .....	<b>50</b>
8.1	Firmware .....	50
8.2	Datasheet .....	50
<b>9.</b>	<b>Package Outline Drawing</b> .....	<b>51</b>

# 1. Overview

## 1.1 Typical Application Circuit - Single Module

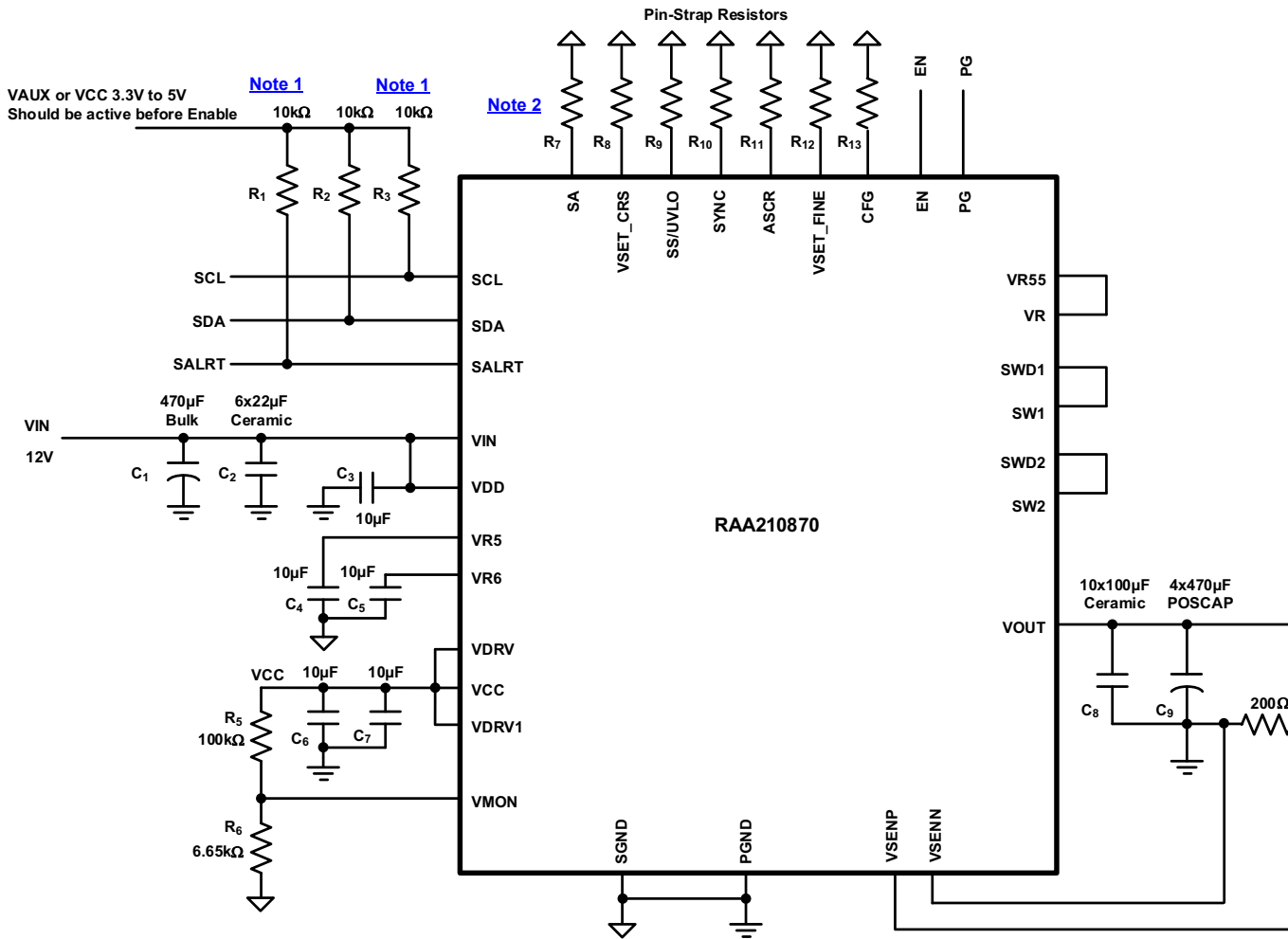

Notes:

1. R<sub>2</sub> and R<sub>3</sub> are not required if the PMBus host already has I<sup>2</sup>C pull-up resistors.
2. R<sub>7</sub> through R<sub>12</sub> can be selected according to the tables for the pin-strap resistor setting in this document.
3. V<sub>25</sub>, VR, and VR55 do not need external capacitors. V<sub>25</sub> can be no connection.

Figure 3. Typical Application Circuit - Single Module

Table 1. RAA210870 Design Guide Matrix and Output Voltage Response

V <sub>IN</sub> (V)	V <sub>OUT</sub> (V)	C <sub>OUT</sub> (Bulk) (μF)	C <sub>OUT</sub> (Ceramic) (μF)	ASCR Residual (Note 7)	ASCR Gain (Note 7)	P-P Deviation (mV)	Recovery Time (μs)	Load Step (A) (Note 6)	Freq. (kHz)
12	0.7	6x680	13x100	90	320	64.21	14.72	0 - 35	364
12	0.7	5x680	9x100	90	550	62.6	9.43	0 - 35	615
5	0.7	6x680	13x100	90	320	61.62	17.57	0 - 35	364
5	0.7	5x680	9x100	90	550	57.08	9.99	0 - 35	615
12	0.8	6x680	11x100	90	280	70.61	16.3	0 - 35	364
12	0.8	4x680	10x100	90	400	74.14	11.43	0 - 35	615
5	0.8	6x680	11x100	90	280	66.84	19.56	0 - 35	364
5	0.8	4x680	10x100	90	400	69.59	11.19	0 - 35	615
12	0.9	6x680	7x100	90	280	74.3	11.13	0 - 35	364
12	0.9	4x680	10x100	90	400	75.18	10.45	0 - 35	615
5	0.9	6x680	7x100	90	240	73.32	17.57	0 - 35	364
5	0.9	4x680	10x100	90	400	71.58	12.45	0 - 35	615
12	1	5x680	9x100	90	240	83.46	13.52	0 - 35	364
12	1	3x680	12x100	90	360	97.73	10.45	0 - 35	615
5	1	5x680	9x100	90	240	77.09	18.37	0 - 35	364
5	1	3x680	12x100	90	360	93.11	10.45	0 - 35	615
12	1.2	4x470	10x100	90	220	105.75	11	0 - 35	421
12	1.2	3x470	10x100	90	360	97.3	8.46	0 - 35	727
5	1.2	4x470	10x100	90	220	107.39	17.99	0 - 35	421
5	1.2	3x470	10x100	90	360	93.39	9.25	0 - 35	727
12	1.5	3x470	9x100	90	200	129	9.93	0 - 35	471
12	1.5	2x470	8x100	100	280	141.29	10.41	0 - 35	727
5	1.5	3x470	9x100	90	200	129.66	20.38	0 - 35	471
5	1.5	2x470	8x100	100	280	137.26	20.78	0 - 35	727
12	1.8	2x470	12x100	100	180	148.86	13	0 - 35	471
12	1.8	1x470	11x100	100	240	167.2	10	0 - 35	727
5	1.8	2x470	12x100	100	180	130.41	24.37	0 - 35	471
5	1.8	1x470	11x100	100	240	163.79	19.98	0 - 35	727
12	2.5	2x470	6x100	90	140	191.78	11.13	0 - 35	533
5	2.5	2x470	6x100	90	140	181.48	37.9	0 - 35	533

## Notes:

- 1x470μF input bulk (EEE1EA471P) and 6x22μF input ceramic (GRM32ER71C226KE18L) capacitors are used for evaluating all test conditions above.
- C<sub>IN</sub> bulk capacitor is optional only for energy buffer from the long input power supply cable.
- Output voltage response is tested with 0% - 50% load step and slew rate at 15A/μs.
- ASCR gain and residual are selected to ensure a phase margin higher than 60° and a gain margin higher than 8dB at ambient room temperature.

**Table 2. Recommended Input/Output Capacitor**

<b>Vendors</b>	<b>Value</b>	<b>Part Number</b>
Murata, Input Ceramic	47 $\mu$ F, 16V, 1210	GRM32ER61C476ME15L
Murata, Input Ceramic	22 $\mu$ F, 25V, 1210	GRM32ER61E226KE15L
Murata, Input Ceramic	22 $\mu$ F, 16V, 1210	GRM32ER71C226KE18L
Murata, Output Ceramic	100 $\mu$ F, 6.3V, 1206	GRM31CR60J107ME39L
TDK, Output Ceramic	100 $\mu$ F, 6.3V, 1206	C3216X5R0J107M160AB
Panasonic, Output Bulk	680 $\mu$ F, 2.5V, 2917	2R5TPF680M6L
Panasonic, Output Bulk	470 $\mu$ F, 4V, 2917	4TPE470MCL
Panasonic, Output Bulk	470 $\mu$ F, 6.3V, 2917	6TPF470MAH
Panasonic, Input Bulk	470 $\mu$ F, 25V	EEE1EA471P

### 1.2 RAA210870 Internal Block Diagram

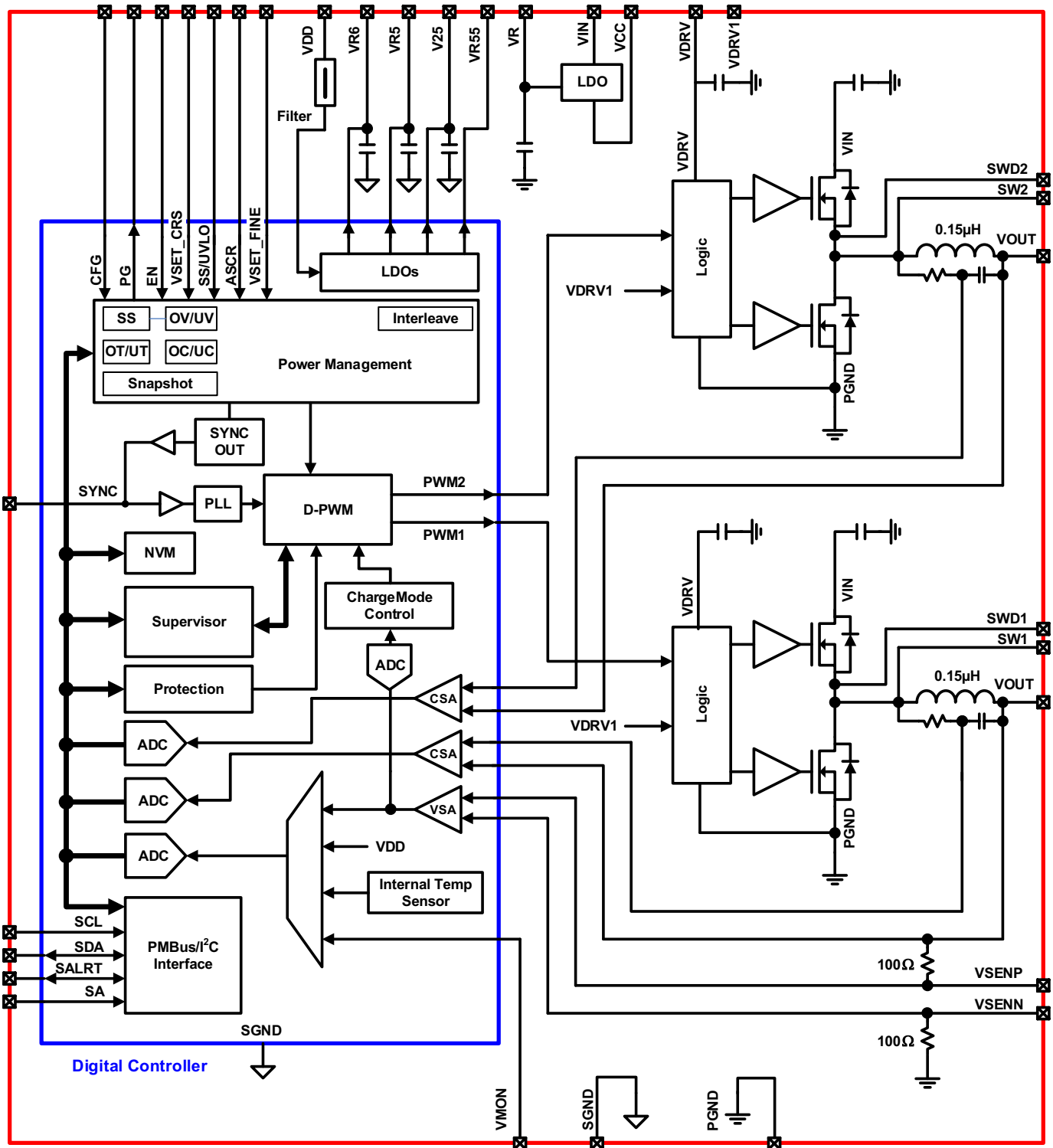

Figure 4. Internal Block Diagram



### 1.3 Ordering Information

Part Number (Notes 9, 10)	Part Marking	Temp Range (°C)	Tape and Reel (Units) (Note 8)	Package (RoHS Compliant)	Pkg. Dwg. #
RAA2108702GLG#AG0	RAA2108702	-40 to +85	-	58 Ld 18x23 HDA Module	Y58.18x23
RAA2108702GLG#HG0	RAA2108702	-40 to +85	100	58 Ld 18x23 HDA Module	Y58.18x23
RTKA2108702H00000BU	Single-Module Evaluation Board				

Notes:

8. Refer to [TB347](#) for details about reel specifications.
9. These Pb-free plastic packaged products are RoHS compliant by EU exemption 7C-I and 7A. They employ special Pb-free material sets; molding compounds/die attach materials and NiPdAu plate-e4 termination finish, which is compatible with both SnPb and Pb-free soldering operations. Pb-free products are MSL classified at Pb-free peak reflow temperatures that meet or exceed the Pb-free requirements of IPC/JEDEC J-STD-020.
10. For Moisture Sensitivity Level (MSL), refer to the [RAA210870](#) device page. For more information about MSL, refer to [TB363](#).

**Table 3. Key Differences between Family of Parts**

Part Number	Description	V <sub>IN</sub> Range (V)	V <sub>OUT</sub> Range (V)	I <sub>OUT</sub> (A)
RAA210833	33A DC/DC single channel power module	4.5 - 14	0.6 - 5	33
RAA210825	25A DC/DC single channel power module	4.5 - 14	0.6 - 5	25
RAA210850	50A DC/DC single channel power module	4.5 - 14	0.6 - 5	50
RAA210870	70A DC/DC single channel power module	4.5 - 14	0.6 - 2.5	70
RAA210925	25A/25A DC/DC dual channel power module	4.5 - 14	0.6 - 5	25/25

**Table 4. Comparison of Simple Digital and Full Digital Parts**

	ISL8273M	RAA210870
V <sub>IN</sub> (V)	4.5-14	4.5-14
V <sub>OUT</sub> (V)	0.6-2.5	0.6-2.5
I <sub>OUT</sub> (Max) (A)	80	70
f <sub>SW</sub> (kHz)	296-1067	296-1067
Digital PMBus Programmability for Configuration of Modules	All PMBus commands. NVM access to store module configuration.	Configuration of modules supported via pin-strap resistors. Digital programmability supports configuration changes during run-time operation with a subset of PMBus commands. No NVM access to store module configuration.
Power Navigator Support	Yes	Yes
SYNC Capability	Yes	Yes
Current Sharing Multi-Modules	Yes	No
DDC Pin (Inter-Device Communication)	Yes	No

Note: For a full comparison of all the RAA210XXX and ISL827XM product offerings please visit the [simple-digital module family](#) page.

### 1.4 Pin Configuration

58 Ld HDA  
Top View

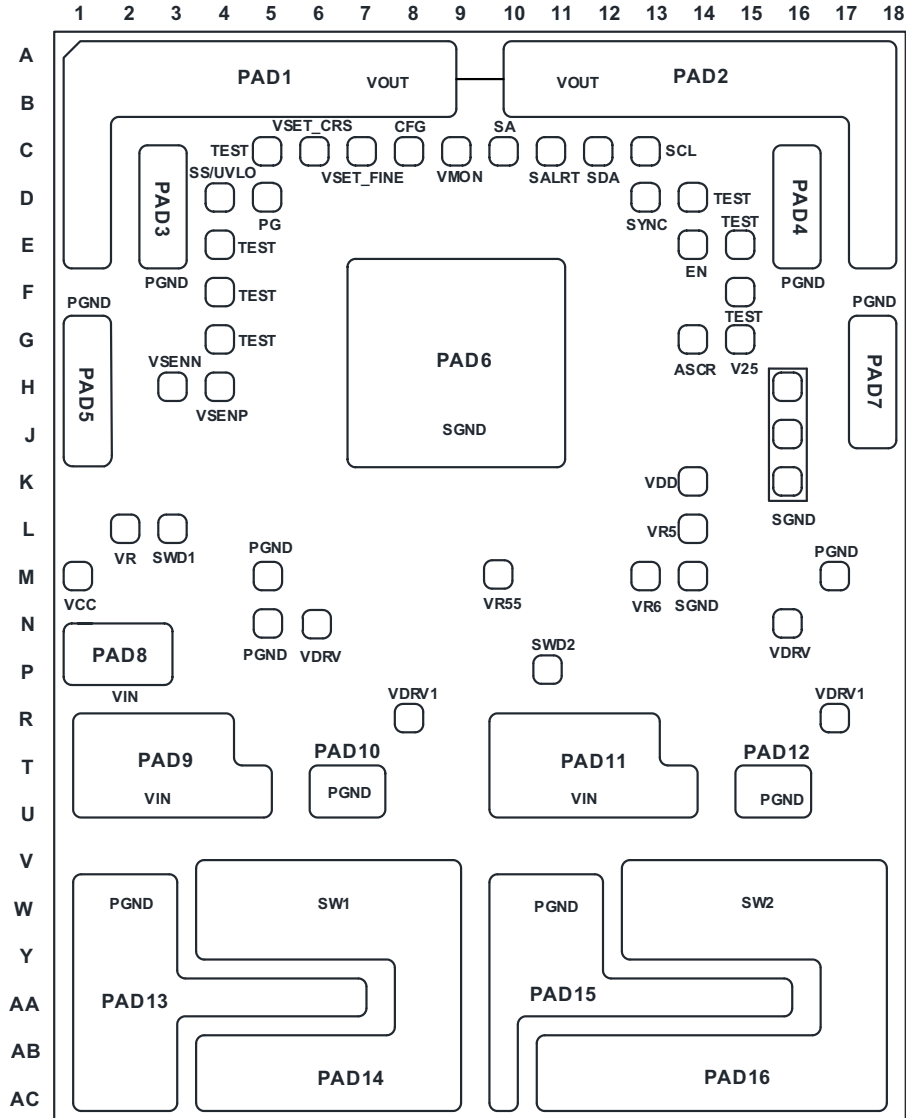

## 1.5 Pin Descriptions

Pin Number	Pin Name	Type	Description
PAD1, PAD2	VOUT	PWR	Power supply output voltage. Output voltage ranges from 0.6V to 2.5V. Tie these two pads together to achieve a single output. For higher output voltage, refer to the derating curves starting on <a href="#">page 19</a> to set the maximum output current from these pads.
PAD3, PAD4, PAD5, PAD7, PAD10, PAD12, PAD13, PAD15	PGND	PWR	Power ground. Refer to the " <a href="#">Layout Guide</a> " on <a href="#">page 30</a> for the PGND pad connections and input/output capacitor placement.
PAD6	SGND	PWR	Signal ground. Refer to " <a href="#">Layout Guide</a> " for the SGND pad connections.
PAD8, PAD9, PAD11	VIN	PWR	Input power supply voltage to power the module. Input voltage ranges from 4.5V to 14V.
PAD14	SW1	PWR	Switching node pads. The SW pads dissipate the heat and provide the good thermal performance. Refer to " <a href="#">Layout Guide</a> " for the SW pad connections.
PAD16	SW2		
C6	VSET_CRS	I	Output voltage selection pin. Used to set $V_{OUT}$ set point. Use VSET_FINE for fine tuning.
C7	VSET_FINE	I	Output voltage fine tuning. Provides increased $V_{OUT}$ resolution based on programmed VSET_CRS value.
C8	CFG	I	Clock source configuration pin. If the clock source is set to internal, the internal frequency is set according to the SYNC pin resistor settings. If the clock source is set to external, the internal frequency is set according to the CFG pin resistor. See " <a href="#">Switching Frequency and PLL</a> " on <a href="#">page 23</a> .
C9	VMON	I	Driver voltage monitoring. Use this pin to monitor VDRV through an external 16:1 resistor divider.
C10	SA	I	Serial address selection pin. Assigns a unique address for each individual device or enables certain management features.
C11	SALRT	O	Serial alert. Connect to external host if desired. SALRT is asserted low upon a fault event and deasserted when the fault is cleared. A pull-up resistor is required.
C12	SDA	I/O	Serial data. Connect to external host and/or to other Digital-DC™ devices. A pull-up resistor is required.
C13	SCL	I/O	Serial clock. Connect to external host and/or to other Digital-DC devices. A pull-up resistor is required.
D4	SS/ UVLO	I	Soft-start/stop and undervoltage lockout selection pin. Sets the turn on/off delay and ramp time in addition to the input UVLO threshold levels.
D5	PG	O	Power-good output. The power-good is configured as an open-drain output.
D13	SYNC	I/O	Clock synchronization input. Sets the frequency of the internal switch clock, syncs to an external clock, or outputs an internal clock. If external synchronization is used, the external clock must be active before enable.
E14	EN	I	Enable pin. Set logic high to enable the module output.
C5, D14, E4, E15, F4, F15, G4	TEST	-	Test pins. Do not connect these pins.
G14	ASCR	I	ChargeMode control ASCR parameters selection pin. Sets the ASCR gain and residual values.
G15	V25	PWR	Internal 2.5V reference used to power internal circuitry. No external capacitor required for this pin. Not recommended to power external circuit.
H3	VSENN	I	Differential output voltage sense feedback. Connect to a negative output regulation point.
H4	VSENP	I	Differential output voltage sense feedback. Connect to a positive output regulation point.
H16, J16, K16, M14	SGND	PWR	Signal grounds. Use multiple vias to connect the SGND pins to the internal SGND layer.
K14	VDD	PWR	Input supply voltage for controller. Connect the VDD pad to the VIN supply.

Pin Number	Pin Name	Type	Description
L2	VR	PWR	Internal LDO bias pin. Tie VR to VR55 directly with a short loop trace. Do not use this pin to power the external circuit.
L3	SWD1	PWR	Switching node driving pins. Directly connect to the SW1 and SW2 pads with short loop wires.
P11	SWD2		
L14	VR5	PWR	Internal 5V reference used to power internal circuitry. Place a 10 $\mu$ F decoupling capacitor for this pin. Maximum external loading current is 5mA.
M1	VCC	PWR	Internal LDO output. Connect VCC to VDRV for internal LDO driving.
M5, M17, N5	PGND	PWR	Power grounds. Use multiple vias to connect the PGND pins to the internal PGND layer.
M10	VR55	PWR	Internal 5.5V bias voltage for internal LDO use only. Tie VR55 pin directly to the VR pin. Not recommended to power external circuits.
M13	VR6	PWR	Internal 6V reference used to power internal circuitry. Place a 10 $\mu$ F decoupling capacitor for this pin. Not recommended to power external circuits.
N6, N16	VDRV	PWR	Power supply for internal FET drivers. Connect a 10 $\mu$ F bypass capacitor to each of these pins. These pins can be driven by the internal LDO through VCC pin or by the external power supply directly. Keep the driving voltage between 4.5V and 5.5V. For 5V input applications, use an external supply or connect this pin to VIN.
R8, R17	VDRV1	I	Bias pin of the internal FET drivers. Always tie to VDRV.

## 2. Specifications

### 2.1 Absolute Maximum Ratings

Parameter	Minimum	Maximum	Unit
Input Supply Voltage, VIN Pin	0.3V	+17	V
Input Supply Voltage for Controller, VDD Pin	-0.3	+17	V
MOSFET Switch Node Voltage, SW1/2, SWD1/2	-0.3	+17	V
MOSFET Driver Supply Voltage, VDRV, VDRV1 Pin	-0.3	+6.0	V
Output Voltage, VOUT pin	-0.3	+6.0	V
Internal Reference Supply Voltage, VR6 Pin	-0.3	+6.6	V
Internal Reference Supply Voltage, VR, VR5, VR55 Pin	-0.3	+6.5	V
Internal Reference Supply Voltage, V25 Pin	-0.3	+3	V
Logic I/O Voltage for EN, CFG, PG, ASCR, VSET_FINE, SA, SCL, SDA, SALRT, SYNC, SS/UVLO, VMON, VSET_CRIS	-0.3	+6.0	V
<b>Analog Input Voltages</b>			
VSENP	-0.3	+6.0	V
VSENN	-0.3	+0.3	V
<b>ESD Rating</b>	<b>Value</b>		<b>Unit</b>
Human Body Model (Tested per JESD22-A114F)	2		kV
Machine Model (Tested per JESD22-A115C)	200		V
Charged Device Model (Tested per JESD22-C110D)	750		V
Latch-up (Tested per JESD78C; Class 2, Level A)	100		mA

CAUTION: Do not operate at or near the maximum ratings listed for extended periods of time. Exposure to such conditions may adversely impact product reliability and result in failures not covered by warranty.

### 2.2 Thermal Information

Thermal Resistance (Typical)	$\theta_{JA}$ (°C/W)	$\theta_{JC}$ (°C/W)
58 Ld HDA Package (Notes 11, 12)	5.3	1.1

Notes:

11.  $\theta_{JA}$  is measured in free air with the module mounted on an 8-layer evaluation board 4.7x4.8inch in size with 2oz Cu on all layers and multiple via interconnects as specified in the RTKA2108702H00000BU evaluation board user guide.

12. For  $\theta_{JC}$ , the "case temp" location is the center of the package underside.

Parameter	Minimum	Maximum	Unit
Maximum Junction Temperature (Plastic Package)		+125	°C
Storage Temperature Range	-55	+150	°C
Pb-Free Reflow Profile	See <a href="#">Figure 25 on page 32</a>		

## 2.3 Recommended Operating Conditions

Parameter	Minimum	Maximum	Unit
Input Supply Voltage Range, $V_{IN}$	4.5	14	V
Input Supply Voltage Range for Controller, $V_{DD}$	4.5	14	V
Output Voltage Range, $V_{OUT}$	0.6	2.5	V
Output Current Range, $I_{OUT(DC)}$ (Note 15)	0	70	A
Operating Junction Temperature Range, $T_J$	-40	+125	°C

## 2.4 Electrical Specifications

$V_{IN} = V_{DD} = 12V$ ,  $f_{SW} = 533kHz$ ,  $T_A = -40^{\circ}C$  to  $+85^{\circ}C$ , unless otherwise noted. Typical values are at  $T_A = +25^{\circ}C$ . **Boldface limits apply across the operating temperature range,  $-40^{\circ}C$  to  $+85^{\circ}C$ .**

Parameter	Symbol	Test Conditions	Min (Note 13)	Typ	Max (Note 13)	Unit
<b>Input and Supply Characteristics</b>						
Input Supply Current for Controller	$I_{DD}$	$V_{IN} = V_{DD} = 12V$ , $V_{OUT} = 0V$ , module not enabled		40	<b>50</b>	mA
6V Internal Reference Supply Voltage	$V_{R6}$		<b>5.5</b>	6.1	<b>6.6</b>	V
5V Internal Reference Supply	$V_{R5}$	$I_{VR5} < 5mA$	<b>4.5</b>	5.2	<b>5.5</b>	V
2.5V Internal Reference Supply	$V_{25}$		<b>2.25</b>	2.5	<b>2.75</b>	V
Internal LDO Output Voltage	$V_{CC}$			5.3		V
Internal LDO Output Current	$I_{VCC}$	$V_{IN} = V_{DD} = 12V$ , $V_{CC}$ connected to VDRV, module enabled	<b>50</b>			mA
Input Supply Voltage for Controller Read Back Resolution	$V_{DD\_READ\_RES}$			$\pm 20$		mV
Input Supply Voltage for Controller Read Back Total Error (Note 16)	$V_{DD\_READ\_ERR}$	PMBus Read		$\pm 2$		% FS
<b>Output Characteristics</b>						
Output Voltage Adjustment Range	$V_{OUT\_RANGE}$	$V_{IN} > V_{OUT} + 1.8V$	<b>0.54</b>		<b>2.75</b>	V
Output Voltage Set-Point Range	$V_{OUT\_RES}$	Configured using PMBus		$\pm 0.025$		%
Output Voltage Set-Point Accuracy (Notes 14, 16)	$V_{OUT\_ACCY}$	Includes line, load, and temperature ( $-20^{\circ}C \leq T_A \leq +85^{\circ}C$ )	<b>-1.2</b>		<b>+1.2</b>	% FS
Output Voltage Read Back Resolution	$V_{OUT\_READ\_RES}$			$\pm 0.15$		% FS
Output Voltage Read Back Total Error (Note 16)	$V_{OUT\_READ\_ERR}$	PMBus read	<b>-2</b>		<b>+2</b>	% FS
Output Ripple Voltage	$V_{OUT\_RIPPLE}$	$V_{OUT} = 1V$ , $C_{OUT} = 6 \times 470\mu F$ POSCAP + $12 \times 100\mu F$ Ceramic		8		mV
Output Current Read Back Resolution	$I_{OUT\_READ\_RES}$			0.087		A
Output Current Range (Note 15)	$I_{OUT\_RANGE}$				<b>70</b>	A
Output Current Read Back Total Error	$I_{OUT\_READ\_ERR}$	PMBus read at max load. $V_{OUT} = 1V$		$\pm 3$		A
<b>Soft-Start and Sequencing</b>						
Delay Time from Enable to $V_{OUT}$ Rise	$t_{ON\_DELAY}$	Configured using pin-strap resistors or PMBus	<b>2</b>		<b>300</b>	ms
$t_{ON\_DELAY}$ Accuracy	$t_{ON\_DELAY\_ACCY}$			$\pm 2$		ms

$V_{IN} = V_{DD} = 12V$ ,  $f_{SW} = 533kHz$ ,  $T_A = -40^{\circ}C$  to  $+85^{\circ}C$ , unless otherwise noted. Typical values are at  $T_A = +25^{\circ}C$ . **Boldface limits apply across the operating temperature range,  $-40^{\circ}C$  to  $+85^{\circ}C$ .** (Continued)

Parameter	Symbol	Test Conditions	Min ( <a href="#">Note 13</a> )	Typ	Max ( <a href="#">Note 13</a> )	Unit
Output Voltage Ramp-Up Time	$t_{ON\_RISE}$	Configured using pin-strap resistors or PMBus	<b>0.5</b>		<b>120</b>	ms
Output Voltage Ramp-Up Time Accuracy	$t_{ON\_RISE\_ACCY}$			$\pm 250$		$\mu s$
Delay Time from Disable to $V_{OUT}$ Fall	$t_{OFF\_DELAY}$	Configured using pin-strap resistors or PMBus	<b>2</b>		<b>300</b>	ms
$t_{OFF\_DELAY}$ Accuracy	$t_{OFF\_DELAY\_ACCY}$			$\pm 2$		ms
Output Voltage Fall Time	$t_{OFF\_FALL}$	Configured using pin-strap resistors or PMBus	<b>0.5</b>		<b>120</b>	ms
Output Voltage Fall Time Accuracy	$t_{ON\_FALL\_ACCY}$			$\pm 250$		$\mu s$
<b>Power-Good</b>						
Power-Good Delay	$V_{PG\_DELAY}$	Configured using PMBus		3		ms
<b>Temperature Sense</b>						
Temperature Sense Range	$T_{SENSE\_RANGE}$	Configurable using PMBus	<b>-50</b>		<b>150</b>	$^{\circ}C$
Internal Temperature Sensor Accuracy	$INT\_TEMP_{ACCY}$	Tested at $+100^{\circ}C$	<b>-5</b>		<b>+5</b>	$^{\circ}C$
<b>Fault Protection</b>						
$V_{DD}$ Undervoltage Threshold Range	$V_{DD\_UVLO\_RANGE}$	Measured internally	<b>4.18</b>		<b>16</b>	V
$V_{DD}$ Undervoltage Threshold Accuracy ( <a href="#">Note 16</a> )	$V_{DD\_UVLO\_ACCY}$			$\pm 2$		%FS
$V_{DD}$ Undervoltage Response Time	$V_{DD\_UVLO\_DELAY}$			10		$\mu s$
$V_{OUT}$ Overvoltage Threshold Range	$V_{OUT\_OV\_RANGE}$	Factory default		$1.15V_{OUT}$		V
		Configured using PMBus	<b><math>1.05V_{OUT}</math></b>		<b><math>V_{OUT\_MAX}</math></b>	V
$V_{OUT}$ Undervoltage Threshold Range	$V_{OUT\_UV\_RANGE}$	Factory default		$0.85V_{OUT}$		V
		Configured using PMBus	<b>0</b>		<b><math>0.95V_{OUT}</math></b>	V
$V_{OUT}$ OV/UV Threshold Accuracy ( <a href="#">Note 14</a> )	$V_{OUT\_OV/UV\_ACCY}$		<b>-2</b>		<b>+2</b>	%
$V_{OUT}$ OV/UV Response Time	$V_{OUT\_OV/UV\_DELAY}$			10		$\mu s$
Output Current Limit Set-Point Accuracy ( <a href="#">Note 16</a> )	$I_{LIMIT\_ACCY}$	Tested at $I_{OUT\_OC\_FAULT\_LIMIT} = 80A$		$\pm 10$		% FS
Output Current Fault Response Time	$I_{LIMIT\_DELAY}$	Factory default		3		$t_{sw}$ ( <a href="#">Note 17</a> )
Over-temperature Protection Threshold (Controller Junction Temperature)	$T_{JUNCTION}$	Factory default		115		$^{\circ}C$
		Configured using PMBus	<b>-40</b>		<b>125</b>	$^{\circ}C$
Thermal Protection Hysteresis	$T_{JUNCTION\_HYS}$			15		$^{\circ}C$
<b>Oscillator and Switching Characteristics</b>						
Switching Frequency Range	$f_{SW\_RANGE}$		<b>296</b>		<b>1067</b>	kHz
Switching Frequency Set-Point Accuracy	$f_{SW\_ACCY}$		<b>-5</b>		<b>+5</b>	%
Minimum Pulse Width Required from External SYNC Clock	$EXT\_SYNC_{PW}$	Measured at 50% Amplitude	<b>150</b>			ns
Drift Tolerance for External SYNC Clock	$EXT\_SYNC_{DRIFT}$	External SYNC Clock equal to 500kHz is not supported	<b>-10</b>		<b>+10</b>	%

$V_{IN} = V_{DD} = 12V$ ,  $f_{SW} = 533kHz$ ,  $T_A = -40^{\circ}C$  to  $+85^{\circ}C$ , unless otherwise noted. Typical values are at  $T_A = +25^{\circ}C$ . **Boldface limits apply across the operating temperature range,  $-40^{\circ}C$  to  $+85^{\circ}C$ .** (Continued)

Parameter	Symbol	Test Conditions	Min (Note 13)	Typ	Max (Note 13)	Unit
<b>Logic Input/Output Characteristics</b>						
Bias Current at the Logic Input Pins	$I_{LOGIC\_BIAS}$	EN, CFG, PG, SA, SCL, SDA, SALRT, SYNC, UVLO, $V_{MON}$ , VSET_CRS	<b>-100</b>		<b>+100</b>	nA
Logic Input Low Threshold Voltage	$V_{LOGIC\_IN\_LOW}$				<b>0.8</b>	V
Logic Input High Threshold Voltage	$V_{LOGIC\_IN\_HIGH}$		<b>2.0</b>			V
Logic Output Low Threshold Voltage	$V_{LOGIC\_OUT\_LOW}$	2mA sinking			<b>0.5</b>	V
Logic Output High Threshold Voltage	$V_{LOGIC\_OUT\_HIGH}$	2mA sourcing	<b>2.25</b>			V
<b>PMBus Interface Timing Characteristic</b>						
PMBus Operating Frequency	$f_{SMB}$		<b>100</b>		<b>400</b>	kHz

## Notes:

13. Compliance to datasheet limits is assured by one or more methods: Production test, characterization, and/or design. Controller is independently tested before module assembly.
14.  $V_{OUT}$  measured at the termination of the VSENP and VSENN sense points.
15. The MAX load current is determined by the thermal ["Derating Curves" on page 19](#).
16. "FS" stands for full scale of recommended maximum operation range.
17. " $t_{SW}$ " stands for time period of operation switching frequency.



### 3. Typical Performance Curves

#### 3.1 Efficiency Performance

$T_A = +25^\circ\text{C}$ , no air flow.  $C_{OUT} = 6 \times 470\mu\text{F POSCAP} + 12 \times 100\mu\text{F Ceramic}$ . Typical values are used unless otherwise noted.

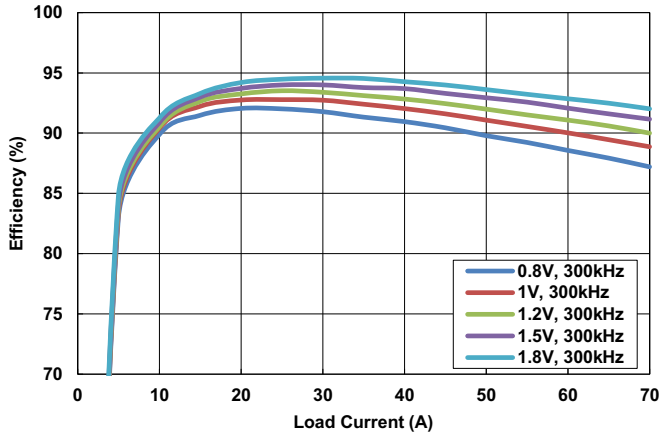

Figure 5. Efficiency vs Output Current at  $V_{IN} = 5\text{V}$ ,  $f_{SW} = 300\text{kHz}$  for Various Output Voltages

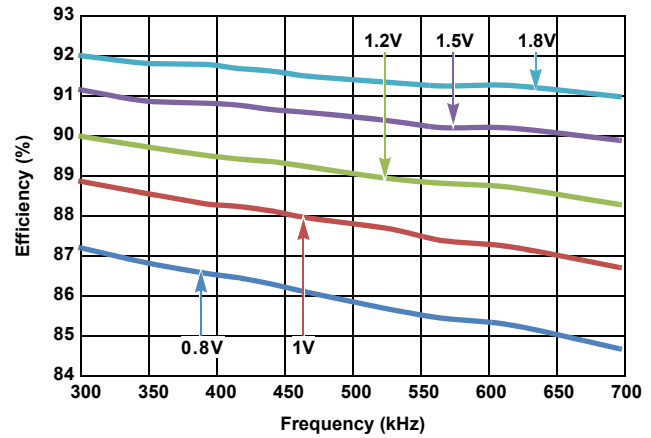

Figure 6. Efficiency vs Switching Frequency at  $V_{IN} = 5\text{V}$ ,  $I_{OUT} = 70\text{A}$  for Various Output Voltages

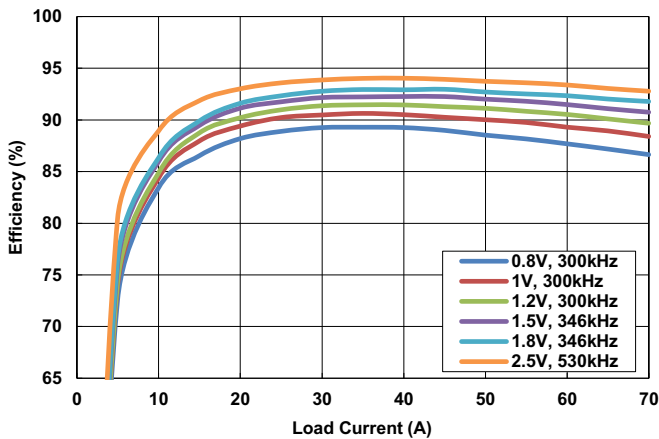

Figure 7. Efficiency vs Output Current at  $V_{IN} = 9\text{V}$ , for Various Output Voltages

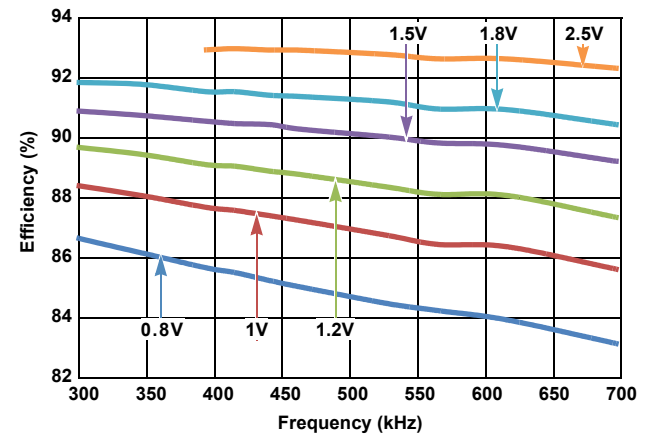

Figure 8. Efficiency vs Switching Frequency at  $V_{IN} = 9\text{V}$ ,  $I_{OUT} = 70\text{A}$  for Various Output Voltages

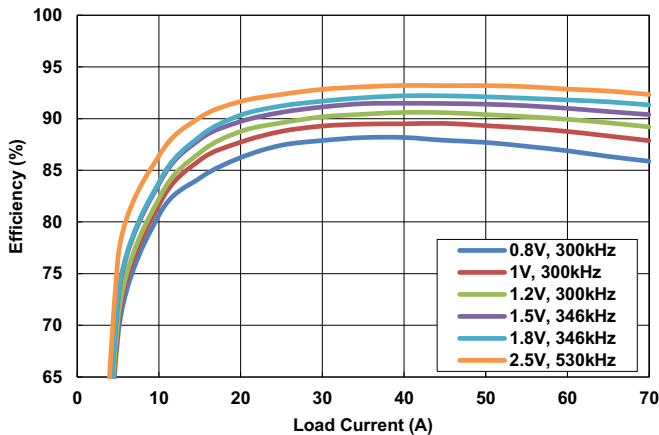

Figure 9. Efficiency vs Output Current at  $V_{IN} = 12\text{V}$ , for Various Output Voltages

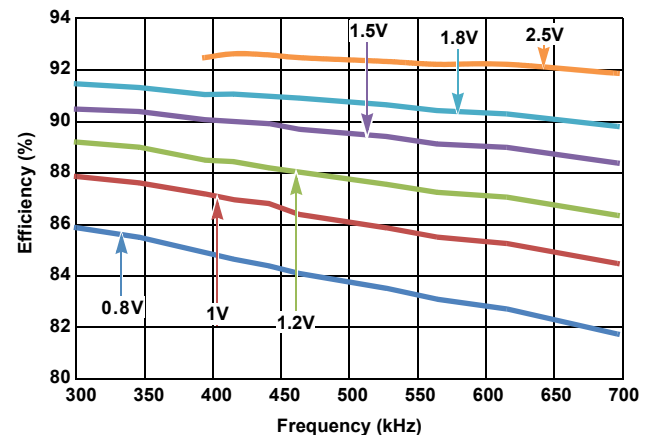

Figure 10. Efficiency vs Switching Frequency at  $V_{IN} = 12\text{V}$ ,  $I_{OUT} = 70\text{A}$  for Various Output Voltages

### 3.2 Transient Response Performance

Operating Conditions:  $I_{OUT} = 0A/35A$ ,  $I_{OUT}$  slew rate =  $15A/\mu s$ ,  $T_A = +25^\circ C$ , 0LFM. Typical values are used unless otherwise noted.

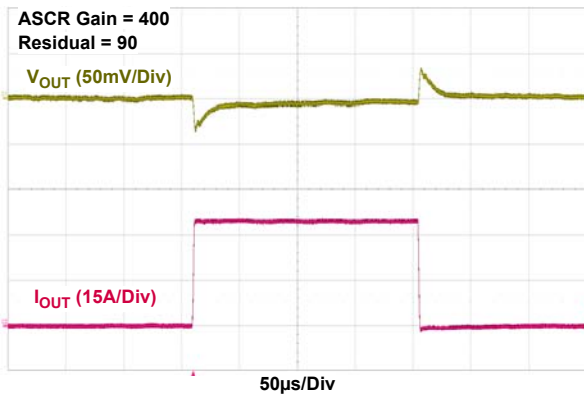

Figure 11.  $5V_{IN}$  to  $0.9V_{OUT}$  Transient Response,  $f_{SW} = 615kHz$ ,  $C_{OUT} = 10 \times 100\mu F$  Ceramic +  $4 \times 680\mu F$  POSCAP

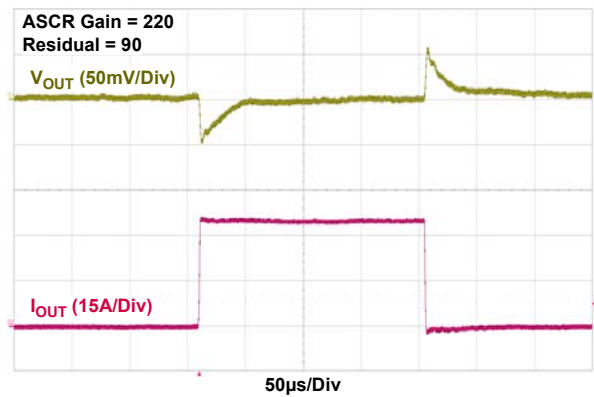

Figure 12.  $5V_{IN}$  to  $1.2V_{OUT}$  Transient Response,  $f_{SW} = 421kHz$ ,  $C_{OUT} = 10 \times 100\mu F$  Ceramic +  $4 \times 470\mu F$  POSCAP

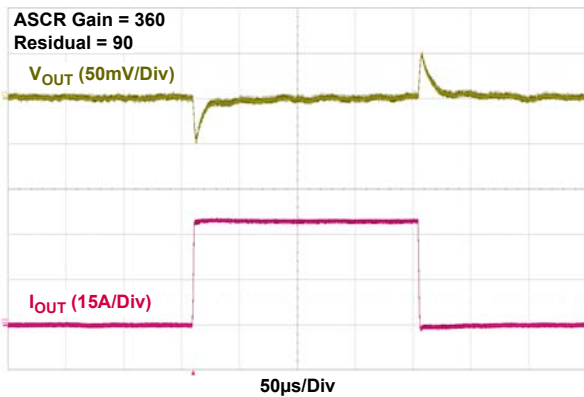

Figure 13.  $12V_{IN}$  to  $1V_{OUT}$  Transient Response,  $f_{SW} = 615kHz$ ,  $C_{OUT} = 12 \times 100\mu F$  Ceramic +  $3 \times 680\mu F$  POSCAP

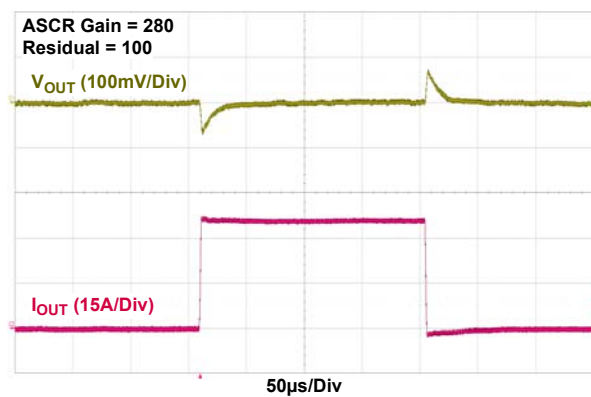

Figure 14.  $12V_{IN}$  to  $1.5V_{OUT}$  Transient Response,  $f_{SW} = 727kHz$ ,  $C_{OUT} = 8 \times 100\mu F$  Ceramic +  $2 \times 470\mu F$  POSCAP

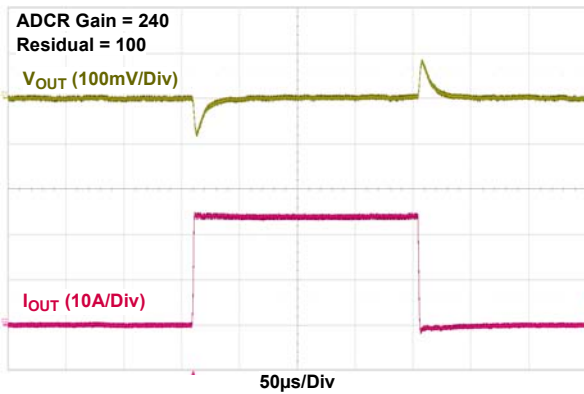

Figure 15.  $12V_{IN}$  to  $1.8V_{OUT}$  Transient Response,  $f_{SW} = 727kHz$ ,  $C_{OUT} = 11 \times 100\mu F$  Ceramic +  $1 \times 470\mu F$  POSCAP

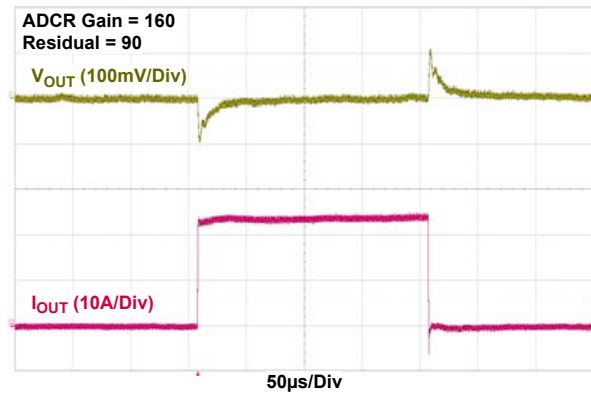

Figure 16.  $12V_{IN}$  to  $2.5V_{OUT}$  Transient Response,  $f_{SW} = 533kHz$ ,  $C_{OUT} = 6 \times 100\mu F$  Ceramic +  $2 \times 470\mu F$  POSCAP

### 3.3 Derating Curves

All of the following curves were plotted at  $T_J = +120^\circ\text{C}$ .

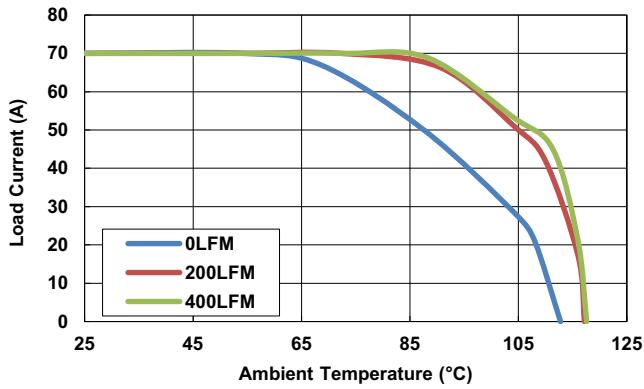

Figure 17.  $5V_{IN}$  to  $1V_{OUT}$ ,  $f_{SW} = 300\text{kHz}$

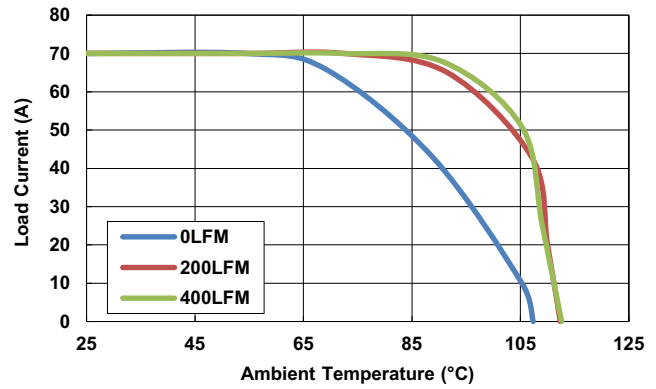

Figure 18.  $12V_{IN}$  to  $1V_{OUT}$ ,  $f_{SW} = 300\text{kHz}$

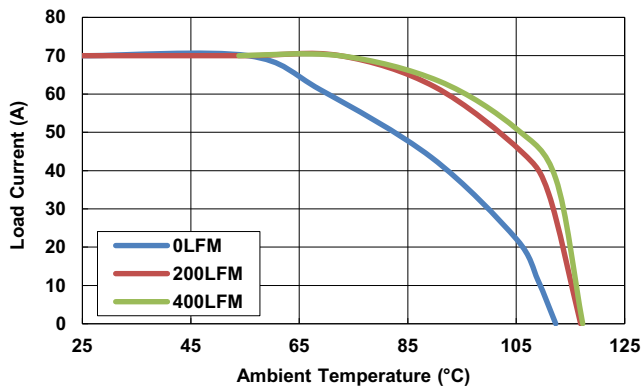

Figure 19.  $5V_{IN}$  to  $1.5V_{OUT}$ ,  $f_{SW} = 300\text{kHz}$

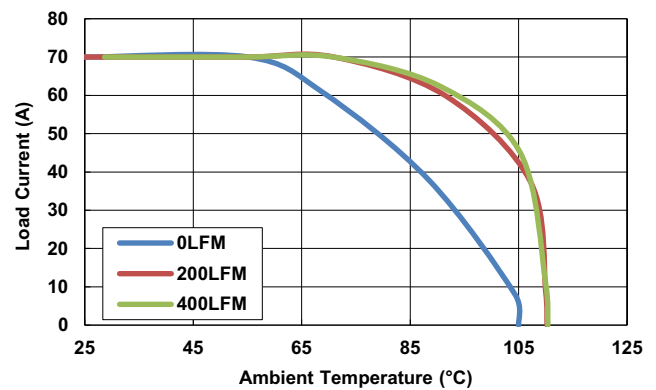

Figure 20.  $12V_{IN}$  to  $1.5V_{OUT}$ ,  $f_{SW} = 364\text{kHz}$

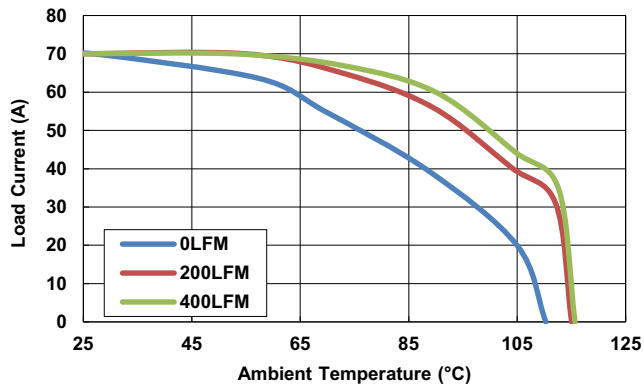

Figure 21.  $5V_{IN}$  to  $2.5V_{OUT}$ ,  $f_{SW} = 364\text{kHz}$

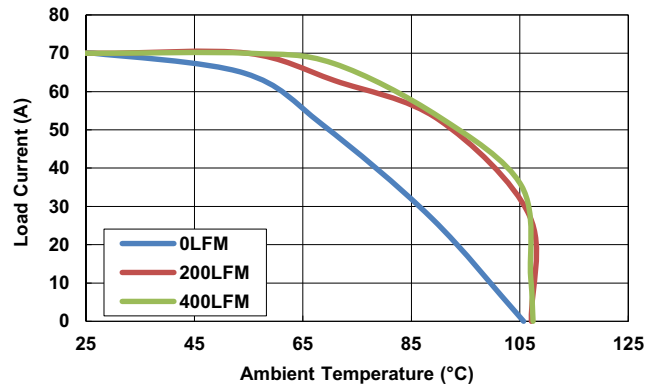

Figure 22.  $12V_{IN}$  to  $2.5V_{OUT}$ ,  $f_{SW} = 533\text{kHz}$

## 4. Functional Description

### 4.1 SMBus Communications

The RAA210870 provides a SMBus digital interface that enables the user to configure the module in addition to monitor the input and output parameters. The RAA210870 can be used with any SMBus host device. The module is compatible with PMBus Power System Management Protocol Specification Parts I and II version 1.2. The RAA210870 accepts most standard PMBus commands. When PMBus commands are issued, it is recommended to tie the enable pin to SGND.

The SMBus device address is the only parameter that must be set by the external pins.

### 4.2 Output Voltage Selection

The output voltage can be set to a voltage between 0.6V and 2.5V if the input voltage is higher than the desired output voltage by an amount sufficient to maintain regulation.

The VSET\_CRS (VOOUT Coarse) and VSET\_FINE (VOOUT Fine) pins are used to set the output voltage. A resistor placed between the VSET\_CRS pin and SGND is used to program the VOUT\_CRS (VOOUT Coarse) voltage according to resistor settings in [Table 5](#). A standard 1% resistor is required.

If higher resolution is desired, then VSET\_FINE pin can be used to fine tune the output voltage settings according to the following command set:

$$\text{VOUT\_COMMAND} = \begin{cases} \text{VOUT\_CRS} + 5\text{mV} \cdot \text{N}, & \text{if } 0.6\text{V} \leq \text{VOUT\_CRS} \leq 1.4\text{V} \\ \text{VOUT\_CRS} + 10\text{mV} \cdot \text{N}, & \text{if } 1.5\text{V} \leq \text{VOUT\_CRS} \leq 2.4\text{V} \\ \text{VOUT\_CRS}, & \text{if } \text{VOUT\_CRS} = 2.5\text{V} \end{cases}$$

Use the resistor values from [Table 6 on page 21](#) to set the appropriate value of N for calculating the final output voltage.

**Table 5. VSET\_COARSE Resistor Settings**

VOUT_CRS (V)	R <sub>SET</sub> (kΩ)
0.600	10
0.675	11
0.700	12.1
0.720	13.3
0.750	14.7
0.800	16.2
0.850	17.8
0.900	19.6
0.930	21.5
0.950	23.7
0.980	26.1
1.000	28.7, or connect to SGND
1.030	31.6
1.050	34.8
1.100	38.3
1.120	42.2
1.150	46.4
1.200	51.1, or OPEN
1.250	56.2

Table 5. VSET\_COARSE Resistor Settings (Continued)

VOUT_CRS (V)	R <sub>SET</sub> (kΩ)
1.300	61.9
1.350	68.1
1.400	75
1.500	82.5
1.650	90.9
1.800	100
1.850	110
2.000	121
2.200	133
2.400	147
2.500	162, or Connect to V25

Table 6. VSET\_FINE Resistor Settings

N	R <sub>SET</sub> (kΩ)
0	10, or OPEN
1	11
2	12.1
3	13.3
4	14.7
5	16.2
6	17.8
7	19.6
8	21.5
9	23.7, or Connect to SGND
10	26.1
11	28.7
12	31.6
13	34.8
14	38.3
15	42.2
16	46.4
17	51.1
18	56.2
19	61.9
20	68.1, or Connect to V25

The output voltage can be set to any value between 0.6V and 2.5V using the pin-strap settings provided in [Tables 5](#) and [6](#).

By default, V<sub>OUT\_MAX</sub> is set to 110% of V<sub>OUT</sub> set by the pin-strap resistor, which can be changed to any value up to 2.75V by the PMBus command VOUT\_MAX.

### 4.3 Soft-Start, Stop Delay, and Ramp Times

The RAA210870 follows an internal start-up procedure after power is applied to the VDD pin. The module requires approximately 60ms to 70ms to check for specific values stored in its internal memory and programmed by pin-strap resistors. When this process is complete, the device is ready to accept commands from the PMBus interface and the module is ready to be enabled. If the module is synchronizing to an external clock source, the clock frequency must be stable before asserting the EN pin.

It may be necessary to set a delay from when an enable signal is received until the output voltage starts to ramp to its target value. In addition, the designer may wish to precisely set the time required for  $V_{OUT}$  to ramp to its target value after the delay period has expired. These features can be used as part of an overall inrush current management strategy or to precisely control how fast a load IC is turned on. The RAA210870 gives the system designer several options for precisely and independently controlling both the delay and ramp time periods. The soft-start delay period begins when the EN pin is asserted and ends when the delay time expires.

The soft-start delay and ramp-up time can be programmed to custom values using the PMBus commands TON\_DELAY and TON\_RISE. When the delay time is set to 0ms, the device begins its ramp-up after the internal circuitry has initialized (approximately 2ms). When the soft-start ramp period is set to 0ms, the output ramps up as quickly as the output load capacitance and loop settings allow. In general, set the soft-start ramp to a value greater than 1ms to prevent inadvertent fault conditions due to excessive inrush current.

Similar to the soft-start delay and ramp-up time, the delay and ramp down time for soft-stop/off can be programmed using the PMBus commands TOFF\_DELAY and TOFF\_FALL. In addition, the module can be configured as “immediate off” using the command ON\_OFF\_CONFIG, so that the internal MOSFETs are turned off immediately after the delay time expires.

The SS/UVLO pin can be used to program the soft-start/stop delay time and ramp time to some typical values as shown in [Table 7](#).

**Table 7. UVLO and Soft-Start/Stop Resistor Settings**

Resistor (k $\Omega$ )	UVLO (V)	Delay Time (ms)	Ramp Time (ms)
10	4.5	5	2
11	4.5	5	2
12.1	4.5	5	2
13.3	4.5	5	2
14.7	4.5	5	2
16.2	4.5	5	2
17.8	4.5	5	2
19.6	4.5	5	2
21.5	4.5	10	2
23.7	4.5	5	5
26.1	4.5	10	5
28.7	4.5	20	5
31.6	4.5	5	10
34.8	4.5	10	10
38.3	4.5	20	10
42.2	10.8	5	2
46.4	10.8	10	2
51.1	10.8	5	5
56.2	10.8	10	5
61.9	10.8	20	5

**Table 7. UVLO and Soft-Start/Stop Resistor Settings (Continued)**

Resistor (k $\Omega$ )	UVLO (V)	Delay Time (ms)	Ramp Time (ms)
68.1	10.8	5	10
75	10.8	10	10
82.5	10.8	20	10
Connect to SGND	4.5	5	2
OPEN	4.2	5	5
Connect to V25	4.5	10	10

#### 4.4 Input Undervoltage Lockout (UVLO)

The input Undervoltage Lockout (UVLO) prevents the RAA210870 from operating when the input falls below a preset threshold, indicating the input supply is out of its specified range. The UVLO threshold ( $V_{UVLO}$ ) can be set between 4.18V and 16V by using the PMBus command `VIN_UV_FAULT_LIMIT`. Use the pin-strap method (SS/UVLO pin) as shown in [Table 7](#) to set the  $V_{UVLO}$  to three typical values.

When the module falls below the UVLO threshold, it shuts down immediately. The fault needs to be cleared before the module can restart.

#### 4.5 Power-Good

The RAA210870 provides a Power-Good (PG) signal that indicates the output voltage is within a specified tolerance of its target level and no fault condition exists. By default, the PG pin asserts if the output is within 10% of the target voltage. This limit can be changed using the PMBus command `POWER_GOOD_ON`.

A PG delay period is defined as the time from when all conditions within the RAA210870 for asserting PG are met to when the PG pin is actually asserted. This feature is commonly used instead of using an external reset controller to control external digital logic. A fixed PG delay of 3ms is programmed for the RAA210870.

#### 4.6 Switching Frequency and PLL

The device's switching frequency is configurable from 296kHz to 1067kHz using the pin-strap method as shown in [Table 9](#), or by using the PMBus command `FREQUENCY_SWITCH`.

**Table 8. Switching Frequency Resistor Settings**

$f_{sw}$ (kHz)	$R_{SET}$ (k $\Omega$ )
296	14.7, or connect to SGND
300	16.2
320	17.8
364	19.6
400	21.5
421	23.7, or OPEN
471	26.1
533	28.7
571	31.6
615	34.8, or connect to V25
727	38.3
800	42.2
842	46.4
889	51.1
1067	56.2

The RAA210870 incorporates an internal Phase-Locked Loop (PLL) to clock the internal circuitry. The PLL can also be driven by an external clock source connected to the SYNC pin. This configuration can be achieved by connecting a resistor to the CFG pin. If the clock source is set to be internal, the internal frequency is set according to the SYNC pin resistor settings as shown in [Table 8 on page 23](#). If clock source is programmed to be external, then the internal frequency is set according to the resistor connected to the CFG pin as shown in [Table 9](#). The external clock signal must not vary more than 10% from its initial value and should have a minimum pulse width of 150ns. The external clock frequency should be within  $\pm 10\%$  of the listed options shown in [Table 9](#).

**Table 9. External Frequency Sync Settings**

Clock Source	Internal FREQUENCY_SWITCH (kHz)	R <sub>SET</sub> (k $\Omega$ )
Internal	Determined by SYNC resistor	10, or OPEN
External	296	11
External	340	12.1
External	390	13.3
External	444	14.7
External	516	16.2, or connect to SGND
External	593	17.8
External	696	19.6
External	800	21.5
External	941	23.7
External	1067	26.1, or Connect to V25

#### 4.7 Loop Compensation

The module loop response is programmable using the pin-strap method or by using the PMBus command ASCR\_CONFIG according to [Table 10](#). The RAA210870 uses the ChargeMode control algorithm that responds to the output current changes within a single PWM switching cycle, achieving a smaller total output voltage variation with less output capacitance than traditional PWM controllers.

**Table 10. ASCR Resistor Settings**

ASCR Gain	ASCR Residual	R <sub>SET</sub> (k $\Omega$ )
100	90	10
110	90	11
120	90	Connect to SGND
140	90	12.1
160	90	13.3
180	90	14.7
200	90	OPEN
220	90	16.2
240	90	17.8
280	90	19.6
320	90	21.5
360	90	23.7
400	90	26.1
450	90	28.7
500	90	31.6
550	90	34.8



Table 10. ASCR Resistor Settings (Continued)

ASCR Gain	ASCR Residual	R <sub>SET</sub> (kΩ)
600	90	38.3
700	90	42.2
800	90	46.4
80	100	51.1
120	100	56.2
160	100	61.9
200	100	68.1
240	100	75
280	100	82.5
320	100	90.9
360	100	100
400	100	110
450	100	121
500	100	Connect to V25
550	100	133
600	100	147
700	100	162
800	100	178

#### 4.8 SMBus Module Address Selection

Each module must have its own unique serial address to distinguish between other devices on the bus. The module address is set by connecting a resistor between pins SA and SGND. [Table 11](#) lists the available module addresses.

Table 11. SMBus Address Resistor Selection

R <sub>SA</sub> (kΩ)	SMBus Address
10	19h
11	1Ah
12.1	1Bh
13.3	1Ch
14.7	1Dh
16.2	1Eh
17.8	1Fh
19.6	20h
21.5	21h
23.7	22h
26.1	23h
28.7	24h
31.6	25h
34.8, or connect to SGND	26h
38.3	27h
42.2, or Open	28h
46.4	29h

Table 11. SMBus Address Resistor Selection (Continued)

$R_{SA}$ (k $\Omega$ )	SMBus Address
51.1	2Ah
56.2	2Bh
61.9	2Ch
68.1	2Dh
75	2Eh
82.5	2Fh
90.9	30h
100	31h
110	32h
121	33h
133	34h
147	35h
162	36h
178	37h

#### 4.9 Output Overvoltage Protection

The RAA210870 has an internal output overvoltage protection circuit that can protect sensitive load circuitry from being subjected to a voltage higher than its prescribed limits. A hardware comparator is used to compare the actual output voltage (seen at pins VSENP, VSENN) to a threshold set to 15% higher than the target output voltage. The fault threshold can be programmed to a desired level by the PMBus command VOUT\_OV\_FAULT\_LIMIT. If the VSENP - VSENN voltage exceeds this threshold, the module initiates an immediate shutdown without retry.

Internal to the module, two 100 $\Omega$  resistors are populated from V<sub>OUT</sub> to VSENP and SGND to VSENN to protect the module from overvoltage conditions in case of open at the voltage sensing pins and differential remote sense traces due to assembly error. As long as differential remote sense traces have low resistance, V<sub>OUT</sub> regulation accuracy is not compromised.

#### 4.10 Output Prebias Protection

An output prebias condition exists when an externally applied voltage is present on a power supply's output before the power supply's control IC is enabled. Certain applications require that the converter not be allowed to sink current during start-up if a prebias condition exists at the output. The RAA210870 provides prebias protection by sampling the output voltage before initiating an output ramp.

If a prebias voltage lower than the target voltage exists after the preconfigured delay period has expired, the target voltage is set to match the existing prebias voltage and both drivers are enabled. The output voltage is then ramped to the final regulation value at the preconfigured ramp rate.

The actual time the output takes to ramp from the prebias voltage to the target voltage varies, depending on the prebias voltage. However, the total time elapsed from when the delay period expires to when the output reaches its target value matches the preconfigured ramp time (see [Figure 23](#)).

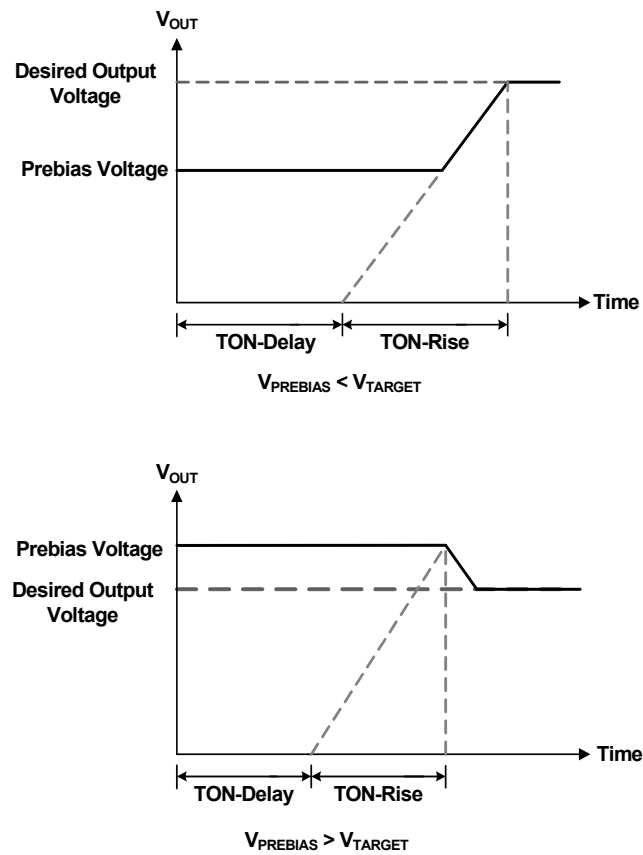

**Figure 23. Output Responses to Prebias Voltages**

If a prebias voltage is higher than the target voltage after the preconfigured delay period has expired, the target voltage is set to match the existing prebias voltage, so both drivers are enabled with a PWM duty cycle that ideally creates the prebias voltage.

When the preconfigured soft-start ramp period has expired, the PG pin is asserted (assuming the prebias voltage is not higher than the overvoltage limit). The PWM then adjusts its duty cycle to match the original target voltage and the output ramps down to the preconfigured output voltage.

If a prebias voltage is higher than the overvoltage limit, the device does not initiate a turn-on sequence and declares an overvoltage fault condition.

#### 4.11 Output Overcurrent Protection

The RAA210870 is protected from damage if the output is shorted to ground or if an overload condition is imposed on the output. The average output overcurrent fault threshold can be programmed by the PMBus command IOUT\_OC\_FAULT\_LIMIT. The module automatically programs the peak inductor current fault threshold by calculating inductor ripple current based on input voltage, switching frequency, and VOUT\_COMMAND.

The response from an overcurrent fault is an immediate shutdown with 70ms retry.

#### 4.12 Thermal Overload Protection

The RAA210870 includes a thermal sensor that continuously measures the internal temperature of the module and shuts down the controller when the temperature exceeds the preset limit. The factory default temperature limit is set to +115°C. The temperature limit can be changed using the PMBus command OT\_FAULT\_LIMIT.

The response from an over-temperature fault is an immediate shutdown without retry.

### 4.13 Phase Spreading

When multiple point-of-load converters share a common DC input supply, adjust the clock phase offset of each device, so that not all devices start to switch simultaneously. Setting each converter to start its switching cycle at a different point in time can dramatically reduce input capacitance requirements and efficiency losses. Because the peak current drawn from the input supply is effectively spread out over a period of time, the peak current drawn at any given moment is reduced, and the power losses proportional to the  $I_{RMS}^2$  are reduced dramatically.

To enable phase spreading, all converters must be synchronized to the same switching clock. The phase offset between devices is determined from the lower four bits of the SMBus address of each interleaved device. The phase offset of each device can be set to any value between  $0^\circ$  and  $360^\circ$  in  $22.5^\circ$  increments. The internal two phases of the module always maintain a phase difference of  $180^\circ$ .

This functionality can also be accessed using the PMBus command INTERLEAVE.

**Table 12. Interleave**

SA	SA in Binary	Low 4-Bits	Interleave	Phase Shift in Degrees	Rail ID
19h	00011001	1001	9	202.5	25
1Ah	00011010	1010	10	225	26
1Bh	00011011	1011	11	247.5	27
1Ch	00011100	1100	12	270	28
1Dh	00011101	1101	13	292.5	29
1Eh	00011110	1110	14	315	30
1Fh	00011111	1111	15	337.5	31
20h	00100000	0000	0	0	0
21h	00100001	0001	1	22.5	1
22h	00100010	0010	2	45	2
23h	00100011	0011	3	67.5	3
24h	00100100	0100	4	90	4
25h	00100101	0101	5	112.5	5
26h	00100110	0110	6	135	6
27h	00100111	0111	7	157.5	7
28h	00101000	1000	8	180	8
29h	00101001	1001	9	202.5	9
2Ah	00101010	1010	10	225	10
2Bh	00101011	1011	11	247.5	11
2Ch	00101100	1100	12	270	12
2Dh	00101101	1101	13	292.5	13
2Eh	00101110	1110	14	315	14
2Fh	00101111	1111	15	337.5	15
30h	00110000	0000	0	0	16
31h	00110001	0001	1	22.5	17
32h	00110010	0010	2	45	18
33h	00110011	0011	3	67.5	19
34h	00110100	0100	4	90	20
35h	00110101	0101	5	112.5	21
36h	00110110	0110	6	135	22
37h	00110111	0111	7	157.5	23

#### 4.14 Monitoring with SMBus

The RAA210870 can monitor a wide variety of different system parameters using the following PMBus commands:

- READ\_VIN
- READ\_VOUT
- READ\_IOUT
- READ\_INTERNAL\_TEMP
- READ\_DUTY\_CYCLE
- READ\_FREQUENCY
- READ\_VMON

#### 4.15 Snapshot Parameter Capture

The RAA210870 offers a special feature to capture parametric data and fault status following a fault event. A detailed description is provided in the [“SNAPSHOT \(EAh\)”](#) and [“SNAPSHOT\\_CONTROL \(F3h\)”](#) sections of [“PMBus Commands Description”](#) on page 36.

## 5. Layout Guide

To achieve stable operation, low losses and good thermal performance some layout considerations are necessary. See [Figure 24](#) for the recommended layout.

- Establish separate SGND and PGND planes, then connect SGND to PGND on a middle layer and underneath PAD6 with a single point connection. For SGND and PGND pin connections, such as small pins H16, J16, M5, and M17..., use multiple vias for each pin to connect to the inner SGND or PGND layer.
- To minimize high frequency noise, place enough ceramic capacitors between VIN and PGND and VOUT and PGND. Place bypass capacitors between VDD, VDRV, and the ground plane, as close to the module as possible. It is critical to place the output ceramic capacitors close to the VOUT pads and in the direction of the load current path to create a low impedance path for the high frequency inductor ripple current.
- Use large copper areas for the power path (VIN, PGND, VOUT) to minimize conduction loss and thermal stress. Also, use multiple vias to connect the power planes in different layers. It is recommended to enlarge PAD11 and 15 and place more vias on them. The ceramic capacitors CIN can be placed on the bottom layer under these two pads.
- Connect remote sensing traces to the regulation point to achieve a tight output voltage regulation and place the two traces in parallel. Route a trace from VSENN and VSENP to the point of load where the tight output voltage is desired. Avoid routing any sensitive signal traces, such as the VSENN, VSENP sensing lines near the SW pins.
- PAD14 and 16 (SW1 and SW2) are noisy pads, but they are beneficial for thermal dissipation. If the noise issue is critical for the application, it is recommended to use only the top layer for the SW pads. For better thermal performance, use multiple vias on these pads to connect into the SW inner and bottom layers. However, caution must be taken when placing a limited area of SW planes in any layer. The SW planes should avoid the sensing signals and should be surrounded by the PGND layer to avoid the noise coupling.
- For pins SWD1 (L3) and SWD2 (P10), it is recommended to connect to the related SW1 and SW2 pads with short loop wires. The wire width should be more than 20 mils.

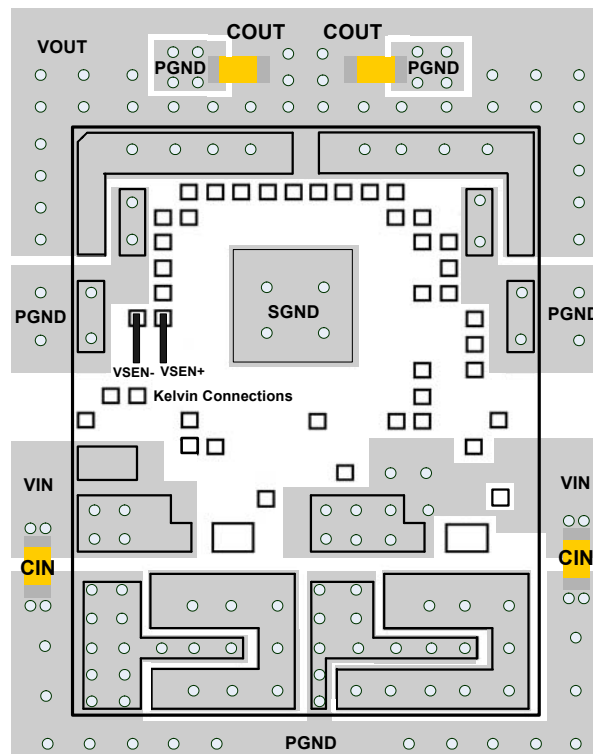

Figure 24. Recommended Layout

## 5.1 Thermal Considerations

Experimental power loss curves along with  $\theta_{JA}$  from thermal modeling analysis can be used to evaluate the thermal consideration for the module. The derating curves are derived from the maximum power allowed while maintaining the temperature below the maximum junction temperature of +125°C. In the actual application, consider other heat sources and design margins.

## 5.2 Package Description

The RAA210870 uses the High Density Array no-lead package (HDA). This kind of package has advantages such as good thermal and electrical conductivity, low weight, and small size. The HDA package is applicable for surface mounting technology and is being more readily used in the industry. The RAA210870 contains several types of devices, including resistors, capacitors, inductors, and control ICs. The RAA210870 is a copper leadframe based package with exposed copper thermal pads, which have good electrical and thermal conductivity. The copper leadframe and multicomponent assembly is overmolded with a polymer mold compound to protect these devices.

The package outline and typical Printed Circuit Board (PCB) layout pattern design and typical stencil pattern design are shown on [pages 51](#) through [57](#). The module has a small size of 18mm x 23mm x 7.5mm.

## 5.3 PCB Layout Pattern Design

The bottom of the RAA210870 is a leadframe footprint, which is attached to the PCB by a surface mounting process. The PCB layout pattern is shown on [pages 56](#) through [57](#). The PCB layout pattern is an array of solder mask defined PCB lands which align with the perimeters of the HDA exposed pads and I/O termination dimensions. The thermal lands on the PCB layout also feature an array of solder mask defined lands and should match 1:1 with the package exposed die pad perimeters. The exposed solder mask defined PCB land area should be 50-80% of the available module I/O area.

## 5.4 Thermal Vias

A grid of 1.0mm to 1.2mm pitch thermal vias, which drops down and connects to buried copper plane(s), should be placed under the thermal land. The vias should be about 0.3mm to 0.33mm in diameter with the barrel plated to about 1.0 oz. of copper. Although adding more vias (by decreasing via pitch) improves the thermal performance, diminishing returns are seen as the number of vias is increased. Use as many vias as practical for the thermal land size and your board design rules allow.

## 5.5 Stencil Pattern Design

Reflowed solder joints on the perimeter I/O lands should have about a 50µm to 75µm (2 mil to 3 mil) standoff height. The solder paste stencil design is the first step in developing optimized, reliable solder joints. Stencil aperture size to solder mask defined PCB land size ratio should typically be 1:1. The aperture width can be reduced slightly to help prevent solder bridging between adjacent I/O lands. A typical solder stencil pattern is shown in the [“Package Outline Drawing”](#) section starting on [page 53](#). Consider the symmetry of the whole stencil pattern when designing its pads. A laser cut, stainless steel stencil with electropolished trapezoidal walls is recommended. Electropolishing “smooths” the aperture walls resulting in reduced surface friction and better paste release, which reduces voids. Using a Trapezoidal Section Aperture (TSA) also promotes paste release and forms a brick like paste deposit that assists in firm component placement. A 0.1mm to 0.15mm stencil thickness is recommended for this large pitch HDA.

## 5.6 Reflow Parameters

Due to the low mount height of the HDA, “No-Clean” Type 3 solder paste per ANSI/J-STD-005 is recommended. A nitrogen purge is also recommended during reflow. A system board reflow profile depends on the thermal mass of the entire populated board, so it is not practical to define a specific soldering profile just for the HDA. The profile given in [Figure 25](#) is provided as a guideline, which can be customized for varying manufacturing practices and applications.

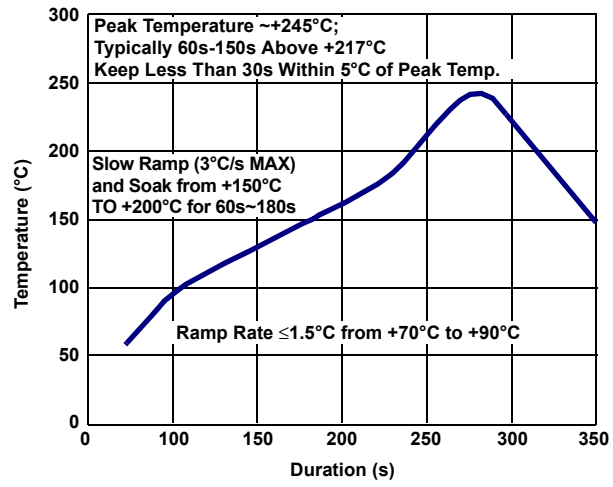

Figure 25. Typical Reflow Profile



## 6. PMBus Command Summary

Command Code	Command Name	Description	Type	Data Format	Default Value	Default Setting	Pg#
01h	OPERATION	Sets enable and disable settings.	R/W Byte	BIT			<a href="#">36</a>
02h	ON_OFF_CONFIG	Configures the EN pin and PMBus commands to turn the unit ON/OFF	R/W Byte	BIT	16h	Hardware enable, soft off	<a href="#">36</a>
03h	CLEAR_FAULTS	Clears fault indications.	Send Byte				<a href="#">36</a>
21h	VOUT_COMMAND	Sets the nominal value of the output voltage.	R/W Word	L16u		V <sub>OUT</sub> Pin-strap (set based on VSET_CRS and VSET_FINE)	<a href="#">37</a>
24h	VOUT_MAX	Sets the maximum possible value of V <sub>OUT</sub> . 110% of pin-strap V <sub>OUT</sub> .	R/W Word	L16u		1.1*V <sub>OUT</sub> Pin-strap	<a href="#">37</a>
33h	FREQUENCY_SWITCH	Sets the switching frequency.	R/W Word	L11		Pin-strap	<a href="#">37</a>
37h	INTERLEAVE	Configures a phase offset between devices sharing a SYNC clock.	R/W Word	BIT	0000h	Pin-strap (set based on SMBus address)	<a href="#">38</a>
40h	VOUT_OV_FAULT_LIMIT	Sets the V <sub>OUT</sub> overvoltage fault threshold.	R/W Word	L16u		1.15*V <sub>OUT</sub> Pin-strap	<a href="#">38</a>
44h	VOUT_UV_FAULT_LIMIT	Sets the V <sub>OUT</sub> undervoltage fault threshold.	R/W Word	L16u		0.85*V <sub>OUT</sub> Pin-strap	<a href="#">38</a>
46h	IOUT_OC_FAULT_LIMIT	Sets the I <sub>OUT</sub> average overcurrent fault threshold.	R/W Word	L11	EAD0h	90A	<a href="#">38</a>
4Bh	IOUT_UC_FAULT_LIMIT	Sets the I <sub>OUT</sub> average undercurrent fault threshold.	R/W Word	L11	E4E0h	-50A	<a href="#">39</a>
4Fh	OT_FAULT_LIMIT	Sets the over-temperature fault threshold.	R/W Word	L11	EB98h	+115°C	<a href="#">39</a>
53h	UT_FAULT_LIMIT	Sets the under-temperature fault threshold.	R/W Word	L11	E530h	-45°C	<a href="#">39</a>
55h	VIN_OV_FAULT_LIMIT	Sets the V <sub>IN</sub> overvoltage fault threshold.	R/W Word	L11	D3A0h	14.5V	<a href="#">39</a>
59h	VIN_UV_FAULT_LIMIT	Sets the V <sub>IN</sub> undervoltage fault threshold.	R/W Word	L11		Pin-strap	<a href="#">40</a>
5Eh	POWER_GOOD_ON	Sets the voltage threshold for Power-good indication.	R/W Word	L16u		0.9*V <sub>OUT</sub> Pin-strap	<a href="#">40</a>
60h	TON_DELAY	Sets the delay time from ENABLE to start of V <sub>OUT</sub> rise.	R/W Word	L11		Pin-strap	<a href="#">40</a>
61h	TON_RISE	Sets the rise time of V <sub>OUT</sub> after ENABLE and TON_DELAY.	R/W Word	L11		Pin-strap	<a href="#">40</a>
64h	TOFF_DELAY	Sets the delay time from DISABLE to start of V <sub>OUT</sub> fall.	R/W Word	L11		Pin-strap	<a href="#">41</a>
65h	TOFF_FALL	Sets the fall time for V <sub>OUT</sub> after DISABLE and TOFF_DELAY.	R/W Word	L11		Pin-strap	<a href="#">41</a>
78h	STATUS_BYTE	Returns an abbreviated status for fast reads.	Read Byte	BIT	00h	No faults	<a href="#">41</a>
79h	STATUS_WORD	Returns information with a summary of the unit's fault condition.	Read Word	BIT	0000h	No faults	<a href="#">42</a>
7Ah	STATUS_VOUT	Returns the V <sub>OUT</sub> specific status.	Read Byte	BIT	00h	No faults	<a href="#">42</a>
7Bh	STATUS_IOUT	Returns the I <sub>OUT</sub> specific status.	Read Byte	BIT	00h	No faults	<a href="#">43</a>

Command Code	Command Name	Description	Type	Data Format	Default Value	Default Setting	Pg#
7Ch	STATUS_INPUT	Returns specific status specific to the input.	Read Byte	BIT	00h	No faults	<a href="#">43</a>
7Dh	STATUS_TEMP	Returns the temperature specific status.	Read Byte	BIT	00h	No faults	<a href="#">43</a>
7Eh	STATUS_CML	Returns the communication, logic, and memory specific status.	Read Byte	BIT	00h	No faults	<a href="#">44</a>
80h	STATUS_MFR_SPECIFIC	Returns the VMON and external sync clock specific status.	Read Byte	BIT	00h	No faults	<a href="#">44</a>
88h	READ_VIN	Returns the input voltage reading.	Read Word	L11			<a href="#">44</a>
8Bh	READ_VOUT	Returns the output voltage reading.	Read Word	L16u			<a href="#">45</a>
8Ch	READ_IOUT	Returns the output current reading.	Read Word	L11			<a href="#">45</a>
8Dh	READ_INTERNAL_TEMP	Returns the temperature reading internal to the device.	Read Word	L11			<a href="#">45</a>
94h	READ_DUTY_CYCLE	Returns the duty cycle reading during the ENABLE state.	Read Word	L11			<a href="#">45</a>
95h	READ_FREQUENCY	Returns the measured operating switch frequency.	Read Word	L11			<a href="#">45</a>
96h	READ_IOUT_0	Returns the phase 1 current reading.	Read Word	L11			<a href="#">46</a>
97h	READ_IOUT_1	Returns the phase 2 current reading.	Read Word	L11			<a href="#">46</a>
DFh	ASCR_CONFIG	Configures ASCR control loop.	R/W Block	CUS		Pin-strap	<a href="#">46</a>
E4h	DEVICE_ID	Returns the 16-byte (character) device identifier string.	Read Block	ASC		Reads device version	<a href="#">46</a>
E5h	MFR_IOUT_OC_FAULT_RESPONSE	Configures the I <sub>OUT</sub> overcurrent fault response.	R/W Byte	BIT	B9h	Disable and 70ms continuous retry	<a href="#">47</a>
E6h	MFR_IOUT_UC_FAULT_RESPONSE	Configures the I <sub>OUT</sub> undercurrent fault response.	R/W Byte	BIT	B9h	Disable and 70ms continuous retry	<a href="#">47</a>
EAh	SNAPSHOT	Returns 32-byte read-back of parametric and status values.	Read Block	BIT			<a href="#">48</a>
F3h	SNAPSHOT_CONTROL	Snapshot feature control command.	R/W Byte	BIT			<a href="#">48</a>
F5h	MFR_VMON_OV_FAULT_LIMIT	Returns the VMON overvoltage threshold.	Read Word	L11	CB00h	6V	<a href="#">49</a>
F6h	MFR_VMON_UV_FAULT_LIMIT	Returns the VMON undervoltage threshold.	Read Word	L11	CA00h	4V	<a href="#">49</a>
F7h	MFR_READ_VMON	Returns the VMON voltage reading.	Read Word	L11			<a href="#">49</a>

### 6.1 PMBus Data Formats

- **Linear-11 (L11)** - The L11 data format uses 5-bit two’s complement exponent (N) and 11-bit two’s complement mantissa (Y) to represent real world decimal value (X).

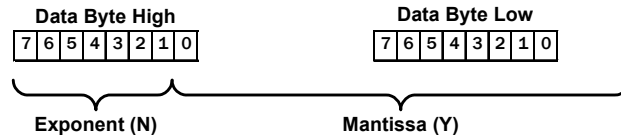

The relation between real world decimal value (X), N, and Y is:  $X = Y \cdot 2^N$

- **Linear-16 Unsigned (L16u)** - The L16u data format uses a fixed exponent (hard-coded to  $N = -13h$ ) and a 16-bit unsigned integer mantissa (Y) to represent real world decimal value (X). The relation between the real world decimal value (X), N and Y is:  $X = Y \cdot 2^{-13}$
- **Linear-16 Signed (L16s)** - The L16s data format uses a fixed exponent (hard-coded to  $N = -13h$ ) and a 16-bit two’s complement mantissa (Y) to represent real world decimal value (X). The relation between the real world decimal value (X), N and Y is:  $X = Y \cdot 2^{-13}$
- **Bit Field (BIT)** - An explanation of the Bit Field for each command is provided in [“PMBus Commands Description” on page 36](#).
- **Custom (CUS)** - An explanation of the Custom data format for each command is provided in [“PMBus Commands Description” on page 36](#). A combination of Bit Field and integer is a common type of Custom data format.
- **ASCII (ASC)** - A variable length string of text characters using the ASCII data format.

### 6.2 PMBus Use Guidelines

The PMBus is a powerful tool that allows the user to optimize circuit performance by configuring devices for their application. When configuring a device in a circuit, the device should be disabled whenever most settings are changed with PMBus commands. Some exceptions to this recommendation are OPERATION, ON\_OFF\_CONFIG, CLEAR\_FAULTS, VOUT\_COMMAND, and ASCR\_CONFIG. While the device is enabled any command can be read. Many commands do not take effect until after the device has been re-enabled, hence the recommendation that commands that change device settings are written while the device is disabled.

In addition, there should be a 2ms delay between repeated READ commands sent to the same device. When sending any other command, a 5ms delay is recommended between repeated commands sent to the same device.

Commands not listed in the PMBus command summary are not allowed for customer use, and are reserved for factory use only. Issuing reserved commands can result in unexpected operation.

## 7. PMBus Commands Description

### OPERATION (01h)

**Definition:** Sets the Enable and Disable settings.

**Data Length in Bytes:** 1

**Data Format:** BIT

**Type:** R/W

**Default Value:**

**Units:** N/A

Settings	Actions
00h	Immediate off
40h	Soft off
80h	On

### ON\_OFF\_CONFIG (02h)

**Definition:** Configures the interpretation and coordination of the OPERATION command and the ENABLE pin (EN).

**Data Length in Bytes:** 1

**Data Format:** BIT

**Type:** R/W

**Default Value:** 16h (Device starts from ENABLE pin with soft-off)

**Units:** N/A

Settings	Actions
16h	Device starts from the ENABLE pin with soft off.
17h	Device starts from the ENABLE pin with immediate off.
1Ah	Device starts from the OPERATION command with soft off.
1Bh	Device starts from the OPERATION command with immediate off.

### CLEAR\_FAULTS (03h)

**Definition:** Clears all fault bits in all registers and releases the SALRT pin (if asserted) simultaneously. If a fault condition still exists, the bit reasserts immediately. This command does not restart a device if it has shut down, it only clears the faults.

**Data Length in Bytes:** 0

**Data Format:** N/A

**Type:** Send byte

**Default Value:** N/A

**Units:** N/A

**Reference:** N/A

**VOUT\_COMMAND (21h)**

**Definition:** Sets or reports the target output voltage. This command cannot set a value higher than VOUT\_MAX.

**Data Length in Bytes:** 2

**Data Format:** L16u

**Type:** R/W

**Default Value:** Pin-strap setting (set based on VSET\_CRS and VSET\_FINE)

**Units:** Volts

**Range:** 0V to VOUT\_MAX

**VOUT\_MAX (24h)**

**Definition:** Sets an upper limit on the output voltage the unit can command regardless of any other commands or combinations. The command provides a safeguard against a user accidentally setting the output voltage to a possibly destructive level rather than to be the primary output overprotection. The default value can be changed using PMBus.

**Data Length in Bytes:** 2

**Data Format:** L16u

**Type:** R/W

**Default Value:** 1.10 x VOUT pin-strap setting

**Units:** Volts

**Range:** 0V to 5.5V

**FREQUENCY\_SWITCH (33h)**

**Definition:** Sets the switching frequency of the device. The initial default value is defined by a pin-strap, and this value can be overridden by writing this command from the PMBus. The output must be disabled when writing this command.

**Data Length in Bytes:** 2

**Data Format:** L11

**Type:** R/W

**Default Value:** Pin-strap setting

**Units:** kHz

**Range:** 296kHz to 1067kHz

**INTERLEAVE (37h)**

**Definition:** Configures the phase offset of a device that is sharing a common SYNC clock with other devices. The phase offset of each device can be set to any value between 0° and 360° in 22.5° increments.

**Data Length in Bytes:** 2

**Data Format:** BIT

**Type:** R/W

**Default Value:** Pin-strap (set based on SMBus address)

**Units:** N/A

Bits	Purpose	Value	Description
15:8	Reserved	0	These bits are reserved
7:4	Group Number	0 to 15	Sets the group number. A value of 0 is interpreted as 16.
3:0	Position in Group	0 to 15	Sets position of the device's rail within the group.

**VOUT\_OV\_FAULT\_LIMIT (40h)**

**Definition:** Sets the  $V_{OUT}$  overvoltage fault threshold.

**Data Length in Bytes:** 2

**Data Format:** L16u

**Type:** R/W

**Default Value:** 1.15xVOUT\_COMMAND pin-strap setting

**Units:** V

**Range:** 0V to VOUT\_MAX

**VOUT\_UV\_FAULT\_LIMIT (44h)**

**Definition:** Sets the  $V_{OUT}$  undervoltage fault threshold. This fault is masked during ramp or when disabled.

**Data Length in Bytes:** 2

**Data Format:** L16u

**Type:** R/W

**Default Value:** 0.85xVOUT pin-strap setting

**Units:** V

**Range:** 0V to VOUT\_MAX

**IOUT\_OC\_FAULT\_LIMIT (46h)**

**Definition:** Sets the  $I_{OUT}$  average overcurrent fault threshold. The device automatically calculates peak inductor overcurrent fault limit for each phase based on the equation:  $I_{OUT(PEAK OC LIMIT)} = (0.5 * I_{OUT\_OC\_FAULT\_LIMIT} + 0.5 * I_{RIPPLE(P-P)}) * 120\%$ . A hard bound of 55A is applied to the peak overcurrent fault limit per phase.

**Data Length in Bytes:** 2

**Data Format:** L11

**Type:** R/W

**Default Value:** EAD0h (90A)

**Units:** A

**Range:** -100A to 100A

**IOUT\_UC\_FAULT\_LIMIT (4Bh)**

**Definition:** Sets the  $I_{OUT}$  average undercurrent fault threshold. The device automatically calculates the valley inductor undercurrent fault limit for each phase based on the equation:  $I_{OUT(VALLEY UC LIMIT)} = (0.5 * I_{OUT\_UC\_FAULT\_LIMIT} - 0.5 * I_{RIPPLE(P-P)}) * 120\%$ . A hard bound of -55A is applied to the valley undercurrent fault limit per phase.

**Data Length in Bytes:** 2

**Data Format:** L11

**Type:** R/W

**Default Value:** E4E0h (-50A)

**Units:** A

**Range:** -100A to 100A

**OT\_FAULT\_LIMIT (4Fh)**

**Definition:** Sets the temperature at which the device should indicate an over-temperature fault. Note that the temperature must drop below the fault level to clear this fault.

**Data Length in Bytes:** 2

**Data Format:** L11

**Type:** R/W

**Default Value:** EB98h (+115°C)

**Units:** Celsius

**Range:** 0°C to +150°C

**UT\_FAULT\_LIMIT (53h)**

**Definition:** Sets the temperature, in degrees Celsius, of the unit where it should indicate an under-temperature fault.

**Data Length in Bytes:** 2

**Data Format:** L11

**Type:** R/W

**Default Value:** E530h (-45°C)

**Units:** Celsius

**Range:** -55°C to +25°C

**VIN\_OV\_FAULT\_LIMIT (55h)**

**Definition:** Sets the  $V_{IN}$  overvoltage fault threshold.

**Data Length in Bytes:** 2

**Data Format:** L11

**Type:** R/W

**Default Value:** D3A0h (14.5V)

**Units:** V

**Range:** 0V to 16V

**VIN\_UV\_FAULT\_LIMIT (59h)**

**Definition:** Sets the  $V_{IN}$  undervoltage fault threshold.

**Data Length in Bytes:** 2

**Data Format:** L11

**Type:** R/W

**Default Value:** Pin-strap setting

**Units:** V

**Range:** 0V to 12V

**POWER\_GOOD\_ON (5Eh)**

**Definition:** Sets the voltage threshold for Power-good indication. Power-good asserts after the output voltage exceeds POWER\_GOOD\_ON . It is recommended to set POWER\_GOOD\_ON higher than VOUT\_UV\_FAULT\_LIMIT.

**Data Length in Bytes:** 2

**Data Format:** L16u

**Type:** R/W

**Default Value:** 0.9 x VOUT pin-strap setting

**Units:** V

**TON\_DELAY (60h)**

**Definition:** Sets the delay time from when the device is enabled to the start of  $V_{OUT}$  rise.

**Data Length in Bytes:** 2

**Data Format:** L11

**Type:** R/W

**Default Value:** Pin-strap setting

**Units:** ms

**Range:** 2ms to 300ms

**TON\_RISE (61h)**

**Definition:** Sets the rise time of  $V_{OUT}$  after ENABLE and TON\_DELAY.

**Data Length in Bytes:** 2

**Data Format:** L11

**Type:** R/W

**Default Value:** Pin-strap setting

**Units:** ms

**Range:** 0ms to 120ms



**TOFF\_DELAY (64h)**

**Definition:** Sets the delay time from DISABLE to start of V<sub>OUT</sub> fall.

**Data Length in Bytes:** 2

**Data Format:** L11

**Type:** R/W

**Default Value:** Pin-strap setting

**Units:** ms

**Range:** 2ms to 300ms

**TOFF\_FALL (65h)**

**Definition:** Sets the soft-off fall time for V<sub>OUT</sub> after DISABLE and TOFF\_DELAY.

**Data Length in Bytes:** 2

**Data Format:** L11

**Type:** R/W

**Default Value:** Pin-strap setting

**Units:** ms

**Range:** 0ms to 120ms

**STATUS\_BYTE (78h)**

**Definition:** Returns one byte of information with a summary of the most critical faults.

**Data Length in Bytes:** 1

**Data Format:** BIT

**Type:** Read-only

**Default Value:** 00h

**Units:** N/A

Bit Number	Status Bit Name	Meaning
7	BUSY	A fault was declared because the device was busy and unable to respond.
6	OFF	This bit is asserted if the unit is not providing power to the output, regardless of the reason, including simply not being enabled.
5	VOUT_OV_FAULT	An output overvoltage fault has occurred.
4	IOUT_OC_FAULT	An output overcurrent fault has occurred.
3	VIN_UV_FAULT	An input undervoltage fault has occurred.
2	TEMPERATURE	A temperature fault has occurred.
1	CML	A communications, memory, or logic fault has occurred.
0	None of the Above	A fault not listed in bits 7:1 has occurred.

**STATUS\_WORD (79h)**

**Definition:** Returns two bytes of information with a summary of the unit's fault condition. Based on the information in these bytes, the host can get more information by reading the appropriate status registers. The low byte of the STATUS\_WORD is the same register as the STATUS\_BYTE (78h) command.

**Data Length in Bytes:** 2

**Data Format:** BIT

**Type:** Read-only

**Default Value:** 0000h

**Units:** N/A

Bit Number	Status Bit Name	Meaning
15	VOUT	An output voltage fault has occurred.
14	IOUT/POUT	An output current or output power fault has occurred.
13	INPUT	An input voltage, input current, or input power fault has occurred.
12	MFG_SPECIFIC	A manufacturer specific fault has occurred.
11	POWER_GOOD#	The POWER_GOOD signal, if present, is negated.
10	Reserved	This bit is reserved.
9	OTHER	A bit in STATUS_OTHER is set.
8	UNKNOWN	A fault type not given in Bits 15:1 of the STATUS_WORD has been detected.
7	BUSY	A fault was declared because the device was busy and unable to respond.
6	OFF	This bit is asserted if the unit is not providing power to the output, regardless of the reason, including simply not being enabled.
5	VOUT_OV_FAULT	An output overvoltage fault has occurred.
4	IOUT_OC_FAULT	An output overcurrent fault has occurred.
3	VIN_UV_FAULT	An input undervoltage fault has occurred.
2	TEMPERATURE	A temperature fault has occurred.
1	CML	A communications, memory, or logic fault has occurred.
0	None of the Above	A fault not listed in Bits 7:1 has occurred.

**STATUS\_VOUT (7Ah)**

**Definition:** Returns one data byte with the status of the output voltage.

**Data Length in Bytes:** 1

**Data Format:** BIT

**Type:** Read-only

**Default Value:** 00h

**Units:** N/A

Bit Number	Status Bit Name	Meaning
7	VOUT_OV_FAULT	Indicates an output overvoltage fault.
6	Reserved	This bit is reserved.
5	Reserved	This bit is reserved.
4	VOUT_UV_FAULT	Indicates an output undervoltage fault.
3:0	N/A	These bits are not used.

**STATUS\_IOUT (7Bh)****Definition:** Returns one data byte with the status of the output current.**Data Length in Bytes:** 1**Data Format:** BIT**Type:** Read-only**Default Value:** 00h**Units:** N/A

Bit Number	Status Bit Name	Meaning
7	IOUT_OC_FAULT	An output overcurrent fault has occurred.
6	Reserved	This bit is reserved.
5	Reserved	This bit is reserved.
4	IOUT_UC_FAULT	An output undercurrent fault has occurred.
3:0	N/A	These bits are not used.

**STATUS\_INPUT (7Ch)****Definition:** Returns the input voltage and input current status information.**Data Length in Bytes:** 1**Data Format:** BIT**Type:** Read-only**Default Value:** 00h**Units:** N/A

Bit Number	Status Bit Name	Meaning
7	VIN_OV_FAULT	An input overvoltage fault has occurred.
6	Reserved	This bit is reserved.
5	Reserved	This bit is reserved.
4	VIN_UV_FAULT	An input undervoltage fault has occurred.
3:0	N/A	These bits are not used.

**STATUS\_TEMPERATURE (7Dh)****Definition:** Returns one byte of information with a summary of any temperature related faults.**Data Length in Bytes:** 1**Data Format:** BIT**Type:** Read-only**Default Value:** 00h**Units:** N/A

Bit Number	Status Bit Name	Meaning
7	OT_FAULT	An over-temperature fault has occurred.
6	Reserved	This bit is reserved.
5	Reserved	This bit is reserved.
4	UT_FAULT	An under-temperature fault has occurred.
3:0	N/A	These bits are not used.

**STATUS\_CML (7Eh)**

**Definition:** Returns one byte of information with a summary of any communications, logic, and/or memory errors.

**Data Length in Bytes:** 1

**Data Format:** BIT

**Type:** Read-only

**Default Value:** 00h

**Units:** N/A

Bit Number	Meaning
7	Invalid or unsupported PMBus command was received.
6	The PMBus command was sent with invalid or unsupported data.
5	Packet error was detected in the PMBus command.
4	Mem/Logic fault.
3:2	Reserved.
1	A PMBus command tried to write to a read-only or protected command, or a communication fault other than the ones listed in this table has occurred.
0	Reserved

**STATUS\_MFR\_SPECIFIC (80h)**

**Definition:** Returns one byte of information providing the status of the device's voltage monitoring and clock synchronization faults.

**Data Length in Bytes:** 1

**Data Format:** BIT

**Type:** Read only

**Default value:** 00h

**Units:** N/A

Bit Number	Field Name	Meaning
7:4	Reserved	These bits are reserved.
3	External Switching Period Fault	Loss of external clock synchronization has occurred.
2	Reserved	This bit is reserved.
1	VMON UV Fault	The voltage on the VMON pin has dropped below the level set by VMON_UV_FAULT_LIMIT.
0	VMON OV Fault	The voltage on the VMON pin has risen above the level set by VMON_OV_FAULT_LIMIT.

**READ\_VIN (88h)**

**Definition:** Returns the input voltage reading.

**Data Length in Bytes:** 2

**Data Format:** L11

**Type:** Read-only

**Units:** V

**READ\_VOUT (8Bh)**

**Definition:** Returns the output voltage reading.

**Data Length in Bytes:** 2

**Data Format:** L16u

**Type:** Read-only

**Units:** V

**READ\_IOUT (8Ch)**

**Definition:** Returns the output current reading.

**Data Length in Bytes:** 2

**Data Format:** L11

**Type:** Read-only

**Default Value:** N/A

**Units:** A

**READ\_INTERNAL\_TEMP (8Dh)**

**Definition:** Returns the controller junction temperature reading from internal temperature sensor. Note that the junction temperature of the power stage in the module may be higher than the READ\_INTERNAL\_TEMP command value, and the temperature difference depends on the operating condition. In some cases, the power stage junction temperature can be 30°C higher than the READ\_INTERNAL\_TEMP command value.

**Data Length in Bytes:** 2

**Data Format:** L11

**Type:** Read-only

**Units:** °C

**READ\_DUTY\_CYCLE (94h)**

**Definition:** Reports the actual duty cycle of the converter during the enable state.

**Data Length in Bytes:** 2

**Data Format:** L11

**Type:** Read only

**Units:** %

**READ\_FREQUENCY (95h)**

**Definition:** Reports the actual switching frequency of the converter during the enable state.

**Data Length in Bytes:** 2

**Data Format:** L11

**Type:** Read only

**Units:** kHz

**READ\_IOUT\_0 (96h)****Definition:** Returns the Phase 1 current reading.**Data Length in Bytes:** 2**Data Format:** L11**Type:** Read-only**Default Value:** N/A**Units:** A**READ\_IOUT\_1 (97h)****Definition:** Returns the Phase 2 current reading.**Data Length in Bytes:** 2**Data Format:** L11**Type:** Read-only**Default Value:** N/A**Units:** A**ASCR\_CONFIG (DFh)**

**Definition:** Allows user configuration of ASCR settings. ASCR gain is analogous to bandwidth and ASCR residual is analogous to damping. To improve load transient response performance, increase ASCR gain. To lower transient response overshoot, increase ASCR residual. Increasing ASCR gain can result in increased PWM jitter and should be evaluated in the application circuit. Excessive ASCR gain can lead to excessive output voltage ripple. Increasing ASCR residual to improve transient response damping can result in slower recovery times, but does not affect the peak output voltage deviation. Typical ASCR gain settings range from 50 to 1000, and ASCR residual settings range from 10 to 100.

**Data Length in Bytes:** 4**Data Format:** CUS**Type:** R/W**Default Value:** Pin-strap setting

Bit	Purpose	Data Format	Value	Description
31:24	Unused		0000000h	Unused
24	Reserved			This bit is reserved
23:16	ASCR Residual Setting	Integer		ASCR residual
15:0	ASCR Gain Setting	Integer		ASCR gain

**DEVICE\_ID (E4h)****Definition:** Returns the 16-byte (character) device identifier string.**Data Length in Bytes:** 16**Data Format:** ASC**Type:** Block Read**Default Value:** Part number/Die revision/Firmware revision

**MFR\_IOUT\_OC\_FAULT\_RESPONSE (E5h)**

**Definition:** Configures the I<sub>OUT</sub> overcurrent fault response as defined by the following table. The command format is the same as the PMBus standard fault responses except that it sets the overcurrent status bit in STATUS\_IOUT.

**Data Length in Bytes:** 1

**Data Format:** BIT

**Type:** R/W

**Default Value:** B9h (Disable, and 70ms continuous retry)

**Units:** N/A

Field Name	Actions
80h	Disable with no retry.
B9h	Disable and continuous retry with 70ms delay

**MFR\_IOUT\_UC\_FAULT\_RESPONSE (E6h)**

**Definition:** Configures the I<sub>OUT</sub> undercurrent fault response as defined by the following table. The command format is the same as the PMBus standard fault responses except that it sets the undercurrent status bit in STATUS\_IOUT.

**Data Length in Bytes:** 1

**Data Format:** BIT

**Type:** R/W

**Default Value:** B9h (Disable and 70ms continuous retry)

**Units:** N/A

Field Name	Actions
80h	Disable with no retry.
B9h	Disable and continuous retry with 70ms delay

**SNAPSHOT (EAh)**

**Definition:** 32-byte read-back of parametric and status values. It allows monitoring and status data to be stored to flash following a fault condition. In case of a fault, last updated values are stored to the flash memory. When the SNAPSHOT STATUS bit is set to stored, the device no longer automatically captures parametric and status values following fault until stored data are erased. Use the SNAPSHOT\_CONTROL command to erase store data and clear the status bit before next ramp up. Data erase is not allowed when the module is enabled.

**Data Length in Bytes:** 32

**Data Format:** Bit field

**Type:** Block Read

Byte Number	Value	Pmbus Command	Format
31:23	Reserved	These bits are reserved	00h
22	Flash Memory Status Byte FF - Not Stored 00 - Stored	N/A	BIT
21	Manufacturer Specific Status Byte	STATUS_MFR_SPECIFIC (80h)	Byte
20	CML Status Byte	STATUS_CML (7Eh)	Byte
19	Temperature Status Byte	STATUS_TEMPERATURE (7Dh)	Byte
18	Input Status Byte	STATUS_INPUT (7Ch)	Byte
17	I <sub>OUT</sub> Status Byte	STATUS_IOUT (7Bh)	Byte
16	V <sub>OUT</sub> Status Byte	STATUS_VOUT (7Ah)	Byte
15:14	Switching Frequency	READ_FREQUENCY (95h)	L11
13:12	Reserved	These bits are reserved	00h
11:10	Internal Temperature	READ_INTERNAL_TEMP (8Dh)	L11
9:8	Duty Cycle	READ_DUTY_CYCLE (94h)	L11
7:6	Reserved	These bits are reserved	L11
5:4	Output Current	READ_IOUT (8Ch)	L11
3:2	Output Voltage	READ_VOUT (8Bh)	L16u
1:0	Input Voltage	READ_VIN (88h)	L11

**SNAPSHOT\_CONTROL (F3h)**

**Definition:** Writing a 01h causes the device to copy the current Snapshot values from NVRAM to the 32-byte Snapshot command parameter. Writing a 02h causes the device to write the current Snapshot values to NVRAM. Writing an 03h erases all Snapshot values from NVRAM. Write (02h) and Erase (03h) can be used only when the device is disabled. All other values are ignored.

**Data Length in Bytes:** 1

**Data Format:** Bit field

**Type:** R/W byte

Value	Description
01h	Read Snapshot values from NV RAM
02h	Write Snapshot values to NV RAM
03h	Erase Snapshot values stored in NV RAM.



**MFR\_VMON\_OV\_FAULT\_LIMIT (F5h)****Definition:** Reads the VMON OV fault threshold.**Data Length in Bytes:** 2**Data Format:** L11**Type:** Read only**Default Value:** CB00h (6V)**Units:** V**Range:** 4V to 6V**MFR\_VMON\_UV\_FAULT\_LIMIT (F6h)****Definition:** Reads the VMON UV fault threshold**Data Length in Bytes:** 2**Data Format:** L11**Type:** Read only**Default Value:** CA00h (4V)**Units:** V**Range:** 4V to 6V**MFR\_READ\_VMON (F7h)****Definition:** Reads the VMON voltage.**Data Length in Bytes:** 2**Data Format:** L11**Type:** Read only**Default Value:** N/A**Units:** V**Range:** 4V to 6V

## 8. Revision History

### 8.1 Firmware

Table 13. RAA210870 Nomenclature Guide

Firmware Revision Code	Change Description	Note
RAA210870--G0100	Initial Release	Recommended for new designs

### 8.2 Datasheet

Rev.	Date	Description
1.0	Oct 23, 2018	Updated PG pin description on page 11. Updated pin configuration to show correct location for M5 and N5. Changed PMBus to SMBus in the SMBus Communications section. Changed 5V to 2.5V in the sentence after Table 6 on page 21. Changed On-Nominal to On in the table under the OPERATION section on page 36. Changed Reserved to Output Current for Bits5:4 value in the SNAPSHOT section on page 48.
0.00	Sep 10, 2018	Initial release

## 9. Package Outline Drawing

Y58.18x23  
58 I/O 18mmx23mmx7.5mm Custom HDA Module  
Rev 4, 4/18

For the most recent package out

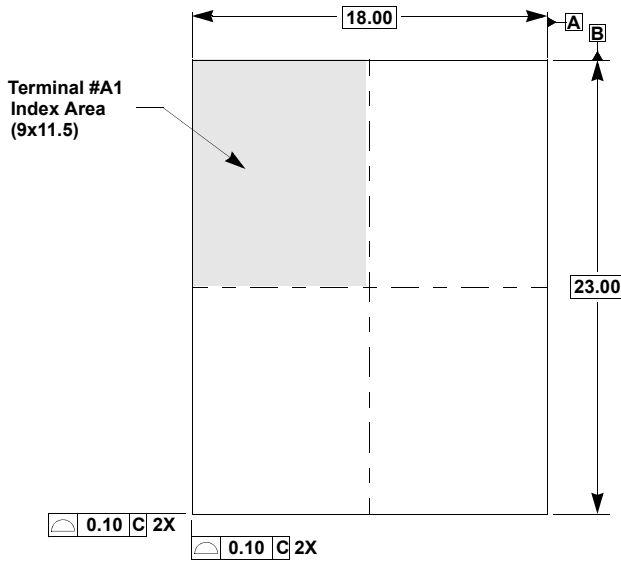

Top View

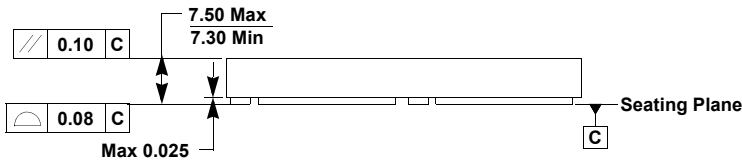

Side View

**Notes:**

1. All dimensions are in millimeters.
2. Represents the basic land grid pitch.
3. These 42 I/Os are centered in a fixed row and column matrix at 1.0mm pitch BSC.
4. Dimensioning and tolerancing per ASME Y14.5-2009.
5. Tolerance for exposed PAD edge location dimension on page 3 is  $\pm 0.1\text{mm}$ .

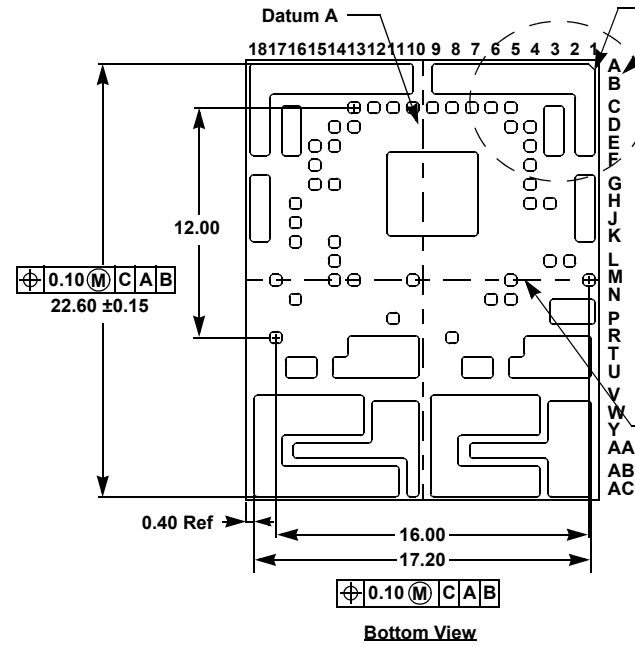

Bottom View

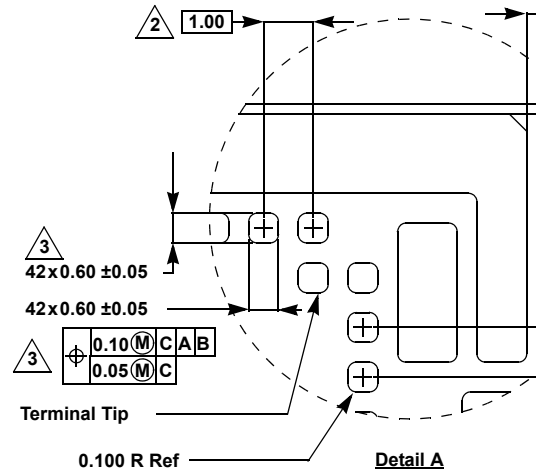

Detail A



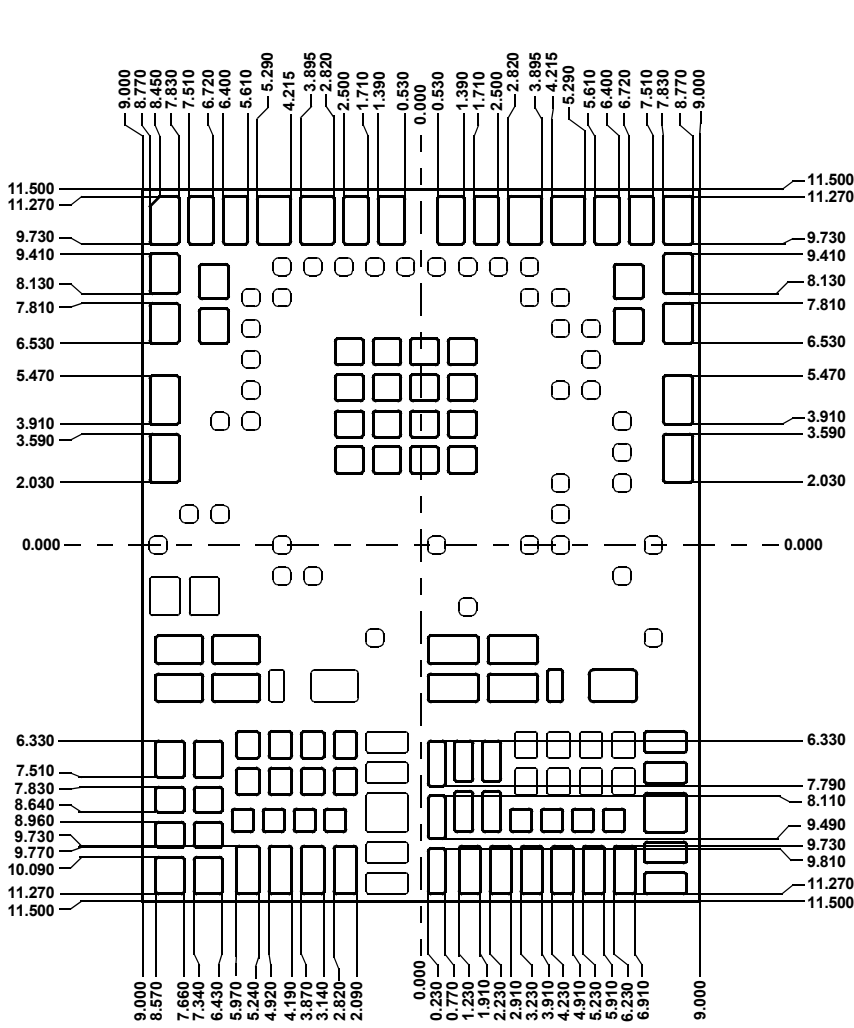

Stencil Opening Edge Position - 1

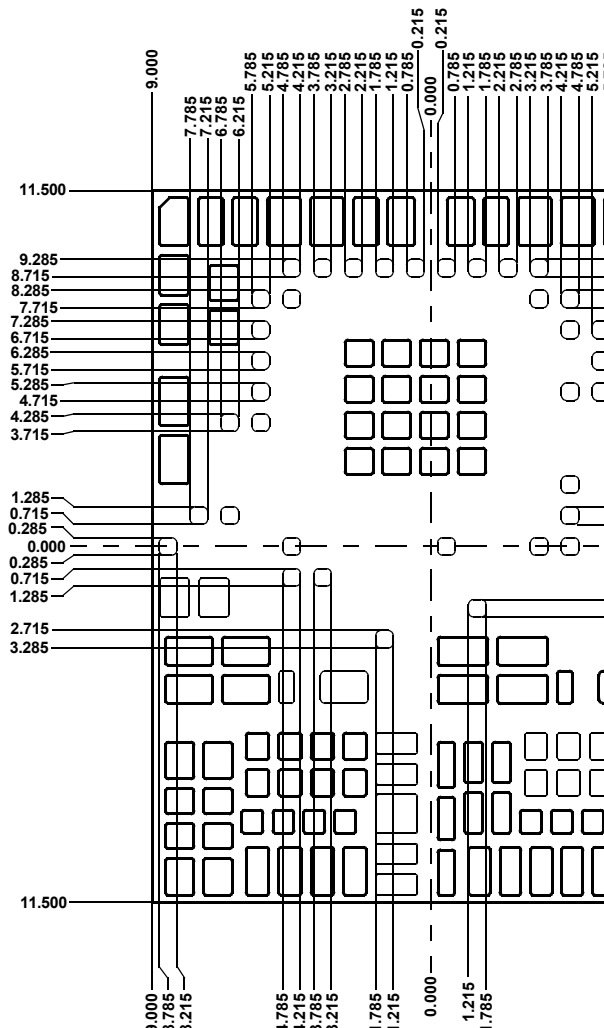

Stencil Opening Edge Position - 2

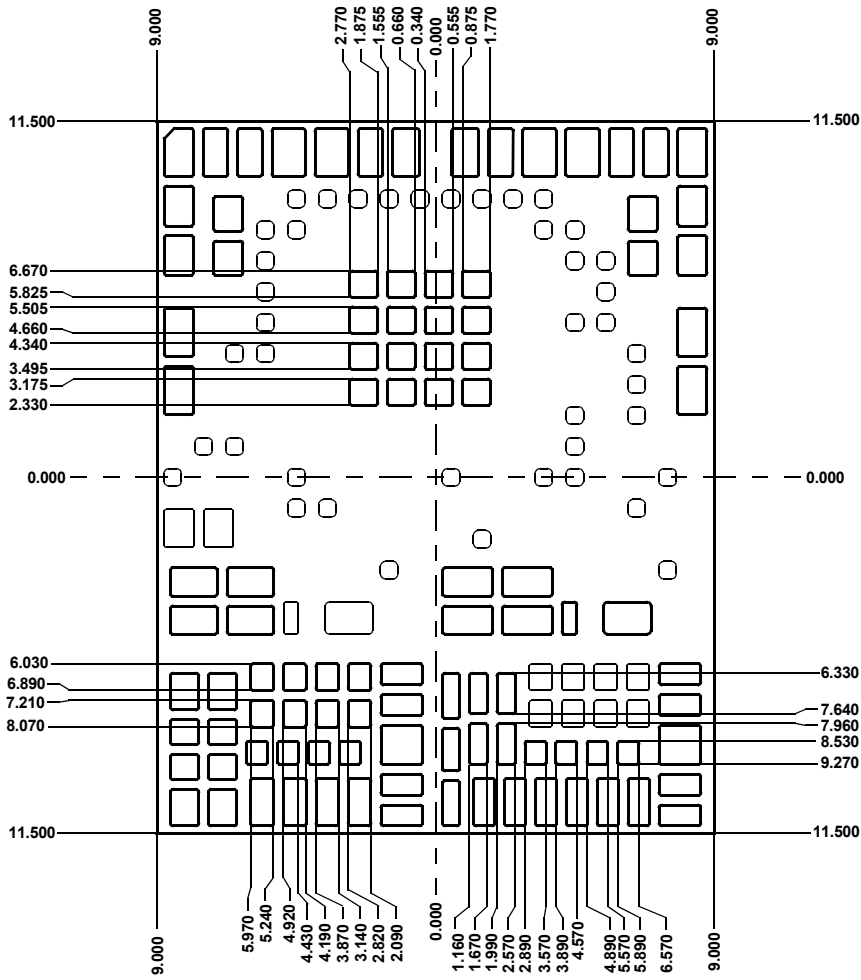

Stencil Opening Edge Position - 3

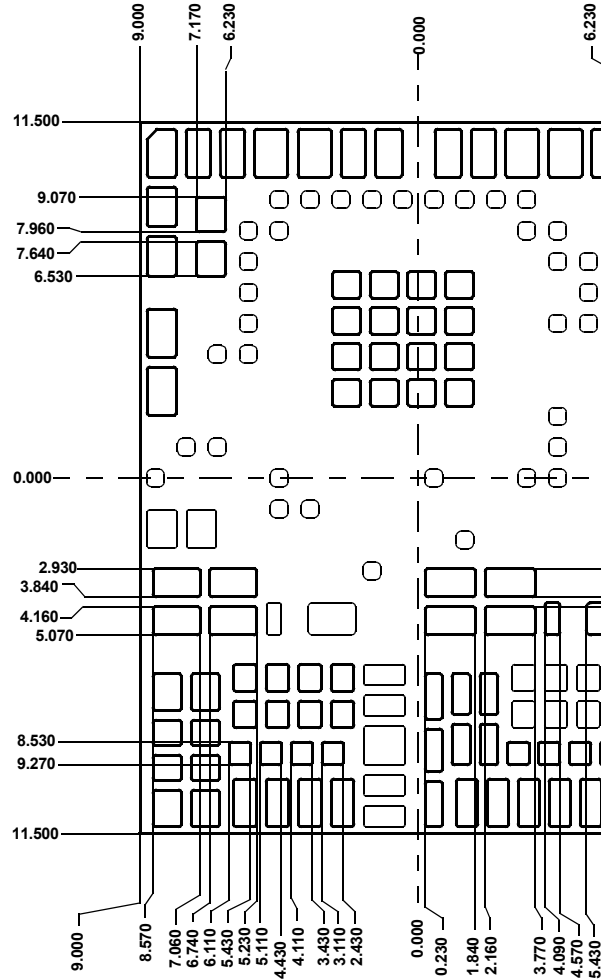

Stencil Opening Edge Position - 4

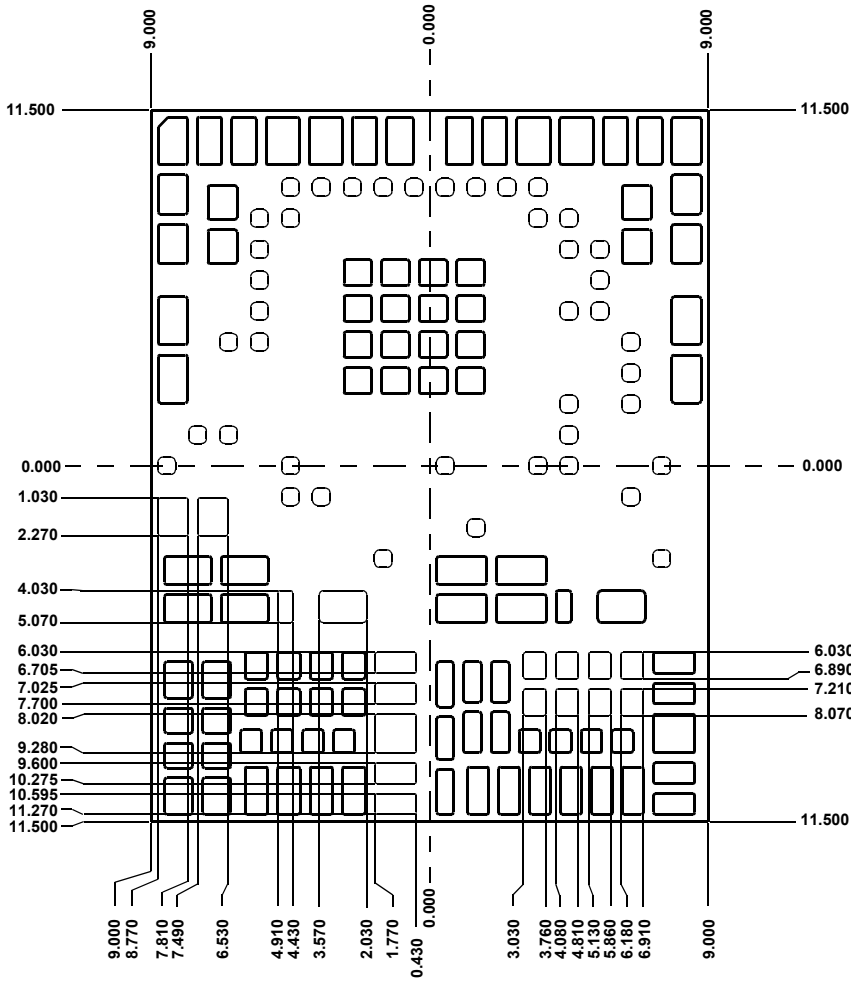

Stencil Opening Edge Position - 5

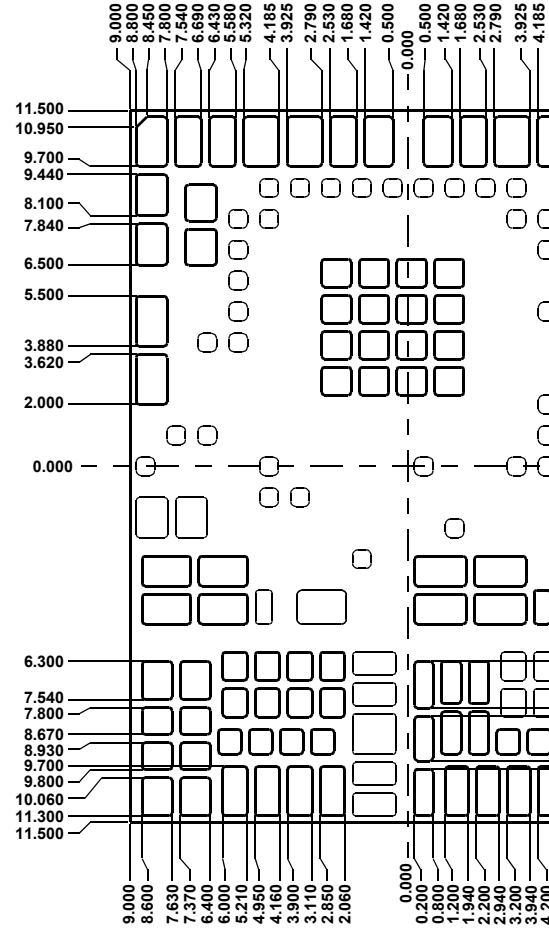

PCB Land Pattern - 1 (for Reference)

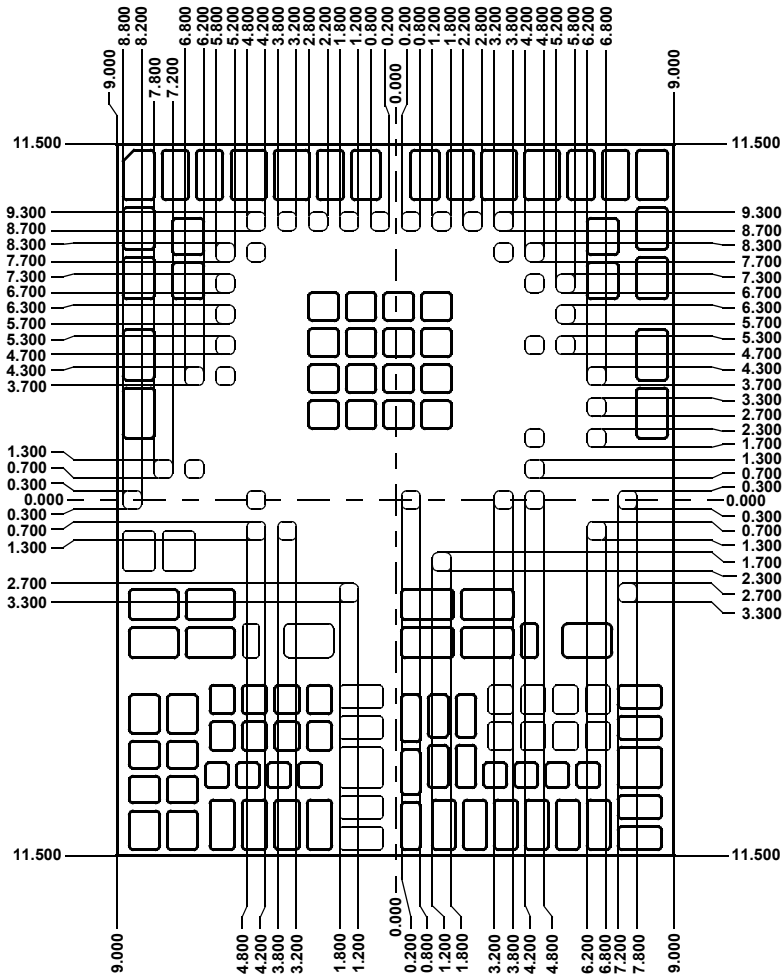

PCB Land Pattern - 2 (for Reference)

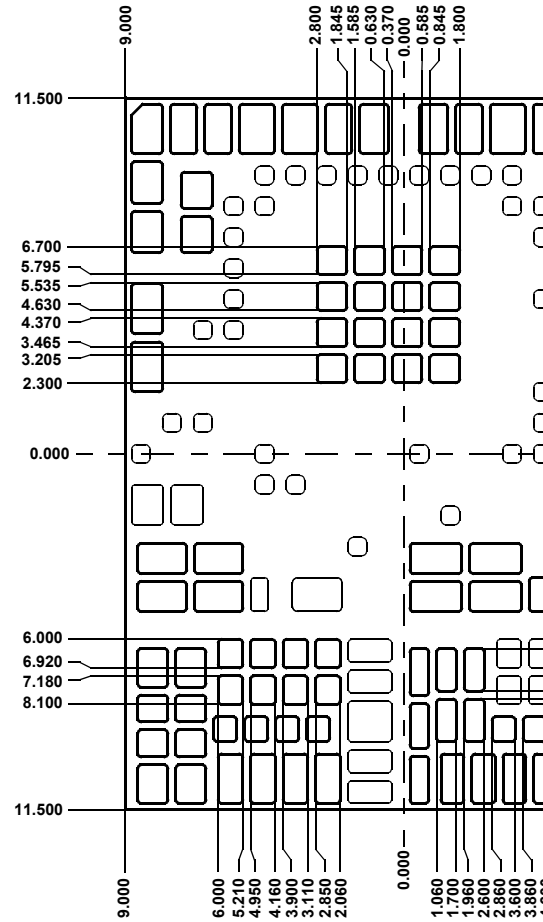

PCB Land Pattern - 3 (for Reference)



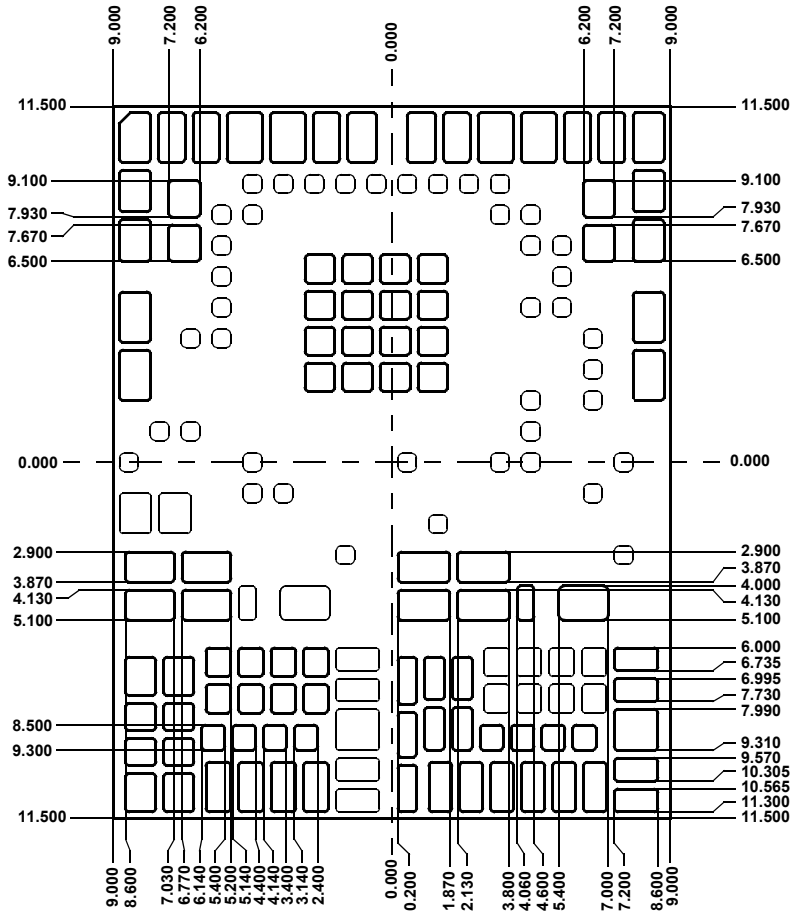

PCB Land Pattern - 4 (for Reference)

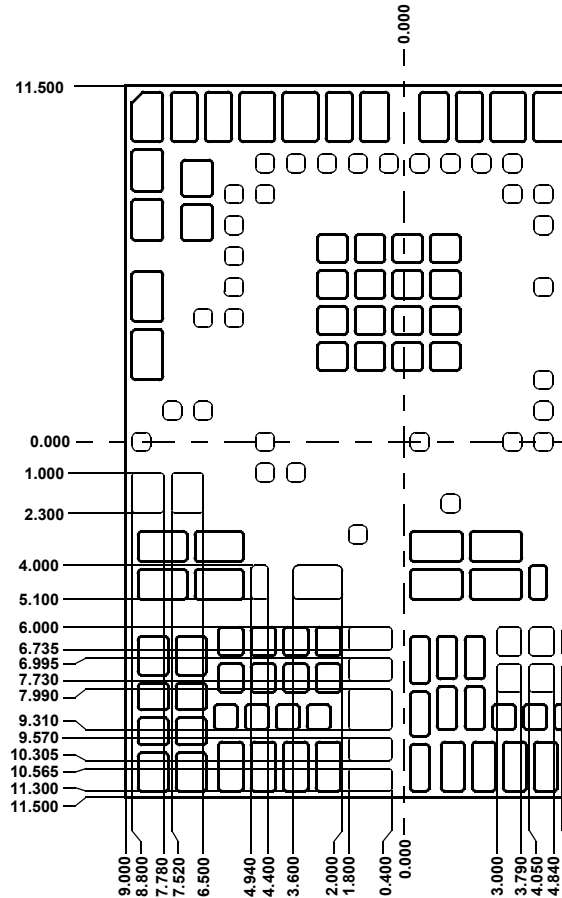

PCB Land Pattern - 5 (for Reference)

## Notice

1. Descriptions of circuits, software and other related information in this document are provided only to illustrate the operation of semiconductor products and application examples. You are fully responsible for the incorporation or any other use of the circuits, software, and information in the design of your product or system. Renesas Electronics disclaims any and all liability for any losses and damages incurred by you or third parties arising from the use of these circuits, software, or information.
  2. Renesas Electronics hereby expressly disclaims any warranties against and liability for infringement or any other claims involving patents, copyrights, or other intellectual property rights of third parties, by or arising from the use of Renesas Electronics products or technical information described in this document, including but not limited to, the product data, drawings, charts, programs, algorithms, and application examples.
  3. No license, express, implied or otherwise, is granted hereby under any patents, copyrights or other intellectual property rights of Renesas Electronics or others.
  4. You shall not alter, modify, copy, or reverse engineer any Renesas Electronics product, whether in whole or in part. Renesas Electronics disclaims any and all liability for any losses or damages incurred by you or third parties arising from such alteration, modification, copying or reverse engineering.
  5. Renesas Electronics products are classified according to the following two quality grades: "Standard" and "High Quality". The intended applications for each Renesas Electronics product depends on the product's quality grade, as indicated below.  
"Standard": Computers; office equipment; communications equipment; test and measurement equipment; audio and visual equipment; home electronic appliances; machine tools; personal electronic equipment; industrial robots; etc.  
"High Quality": Transportation equipment (automobiles, trains, ships, etc.); traffic control (traffic lights); large-scale communication equipment; key financial terminal systems; safety control equipment; etc.  
Unless expressly designated as a high reliability product or a product for harsh environments in a Renesas Electronics data sheet or other Renesas Electronics document, Renesas Electronics products are not intended or authorized for use in products or systems that may pose a direct threat to human life or bodily injury (artificial life support devices or systems; surgical implantations; etc.), or may cause serious property damage (space system; undersea repeaters; nuclear power control systems; aircraft control systems; key plant systems; military equipment; etc.). Renesas Electronics disclaims any and all liability for any damages or losses incurred by you or any third parties arising from the use of any Renesas Electronics product that is inconsistent with any Renesas Electronics data sheet, user's manual or other Renesas Electronics document.
  6. When using Renesas Electronics products, refer to the latest product information (data sheets, user's manuals, application notes, "General Notes for Handling and Using Semiconductor Devices" in the reliability handbook, etc.), and ensure that usage conditions are within the ranges specified by Renesas Electronics with respect to maximum ratings, operating power supply voltage range, heat dissipation characteristics, installation, etc. Renesas Electronics disclaims any and all liability for any malfunctions, failure or accident arising out of the use of Renesas Electronics products outside of such specified ranges.
  7. Although Renesas Electronics endeavors to improve the quality and reliability of Renesas Electronics products, semiconductor products have specific characteristics, such as the occurrence of failure at a certain rate and malfunctions under certain use conditions. Unless designated as a high reliability product or a product for harsh environments in a Renesas Electronics data sheet or other Renesas Electronics document, Renesas Electronics products are not subject to radiation resistance design. You are responsible for implementing safety measures to guard against the possibility of bodily injury, injury or damage caused by fire, and/or danger to the public in the event of a failure or malfunction of Renesas Electronics products, such as safety design for hardware and software, including but not limited to redundancy, fire control and malfunction prevention, appropriate treatment for aging degradation or any other appropriate measures. Because the evaluation of microcomputer software alone is very difficult and impractical, you are responsible for evaluating the safety of the final products or systems manufactured by you.
  8. Please contact a Renesas Electronics sales office for details as to environmental matters such as the environmental compatibility of each Renesas Electronics product. You are responsible for carefully and sufficiently investigating applicable laws and regulations that regulate the inclusion or use of controlled substances, including without limitation, the EU RoHS Directive, and using Renesas Electronics products in compliance with all these applicable laws and regulations. Renesas Electronics disclaims any and all liability for damages or losses occurring as a result of your noncompliance with applicable laws and regulations.
  9. Renesas Electronics products and technologies shall not be used for or incorporated into any products or systems whose manufacture, use, or sale is prohibited under any applicable domestic or foreign laws or regulations. You shall comply with any applicable export control laws and regulations promulgated and administered by the governments of any countries asserting jurisdiction over the parties or transactions.
  10. It is the responsibility of the buyer or distributor of Renesas Electronics products, or any other party who distributes, disposes of, or otherwise sells or transfers the product to a third party, to notify such third party in advance of the contents and conditions set forth in this document.
  11. This document shall not be reprinted, reproduced or duplicated in any form, in whole or in part, without prior written consent of Renesas Electronics.
  12. Please contact a Renesas Electronics sales office if you have any questions regarding the information contained in this document or Renesas Electronics products.
- (Note 1) "Renesas Electronics" as used in this document means Renesas Electronics Corporation and also includes its directly or indirectly controlled subsidiaries.  
(Note 2) "Renesas Electronics product(s)" means any product developed or manufactured by or for Renesas Electronics.

(Rev.4.0-1 November 2017)



### SALES OFFICES

Renesas Electronics Corporation

<http://www.renesas.com>

Refer to "<http://www.renesas.com/>" for the latest and detailed information.

#### Renesas Electronics Corporation

TOYOSU FORESIA, 3-2-24 Toyosu, Koto-ku, Tokyo 135-0061, Japan

#### Renesas Electronics America Inc.

1001 Murphy Ranch Road, Milpitas, CA 95035, U.S.A.  
Tel: +1-408-432-8888, Fax: +1-408-434-5351

#### Renesas Electronics Canada Limited

9251 Yonge Street, Suite 8309 Richmond Hill, Ontario Canada L4C 9T3  
Tel: +1-905-237-2004

#### Renesas Electronics Europe Limited

Dukes Meadow, Millboard Road, Bourne End, Buckinghamshire, SL8 5FH, U.K  
Tel: +44-1628-651-700

#### Renesas Electronics Europe GmbH

Arcadiastrasse 10, 40472 Düsseldorf, Germany  
Tel: +49-211-6503-0, Fax: +49-211-6503-1327

#### Renesas Electronics (China) Co., Ltd.

Room 1709 Quantum Plaza, No.27 ZhichunLu, Haidian District, Beijing, 100191 P. R. China  
Tel: +86-10-8235-1155, Fax: +86-10-8235-7679

#### Renesas Electronics (Shanghai) Co., Ltd.

Unit 301, Tower A, Central Towers, 555 Langao Road, Putuo District, Shanghai, 200333 P. R. China  
Tel: +86-21-2226-0888, Fax: +86-21-2226-0999

#### Renesas Electronics Hong Kong Limited

Unit 1601-1611, 16/F., Tower 2, Grand Century Place, 193 Prince Edward Road West, Mongkok, Kowloon, Hong Kong  
Tel: +852-2265-6688, Fax: +852 2886-9022

#### Renesas Electronics Taiwan Co., Ltd.

13F, No. 363, Fu Shing North Road, Taipei 10543, Taiwan  
Tel: +886-2-8175-9600, Fax: +886 2-8175-9670

#### Renesas Electronics Singapore Pte. Ltd.

80 Bendemeer Road, Unit #06-02 Hyflux Innovation Centre, Singapore 339949  
Tel: +65-6213-0200, Fax: +65-6213-0300

#### Renesas Electronics Malaysia Sdn.Bhd.

Unit 1207, Block B, Menara Amcorp, Amcorp Trade Centre, No. 18, Jln Persiaran Barat, 46050 Petaling Jaya, Selangor Darul Ehsan, Malaysia  
Tel: +60-3-7955-9390, Fax: +60-3-7955-9510

#### Renesas Electronics India Pvt. Ltd.

No.777C, 100 Feet Road, HAL 2nd Stage, Indiranagar, Bangalore 560 038, India  
Tel: +91-80-67208700, Fax: +91-80-67208777

#### Renesas Electronics Korea Co., Ltd.

17F, KAMCO Yangjae Tower, 262, Gangnam-daero, Gangnam-gu, Seoul, 06265 Korea  
Tel: +82-2-558-3737, Fax: +82-2-558-5338

## X-ON Electronics

Largest Supplier of Electrical and Electronic Components

*Click to view similar products for [Switching Voltage Regulators](#) category:*

*Click to view products by [Renesas](#) manufacturer:*

Other Similar products are found below :

[FAN53610AUC33X](#) [FAN53611AUC123X](#) [FAN48610BUC33X](#) [FAN48610BUC45X](#) [FAN48617UC50X](#) [R3](#) [430464BB](#) [KE177614](#)  
[FAN53611AUC12X](#) [MAX809TTR](#) [NCV891234MW50R2G](#) [NCP81103MNTXG](#) [NCP81203PMNTXG](#) [NCP81208MNTXG](#)  
[NCP81109GMNTXG](#) [SCY1751FCCT1G](#) [NCP81109JMNTXG](#) [AP3409ADNTR-G1](#) [NCP81241MNTXG](#) [LTM8064IY](#) [LT8315EFE#TRPBF](#)  
[LTM4664EY#PBF](#) [LTM4668AIY#PBF](#) [NCV1077CSTBT3G](#) [XCL207A123CR-G](#) [MPM54304GMN-0002](#) [MPM54304GMN-0004](#)  
[MPM54304GMN-0003](#) [AP62300Z6-7](#) [MP8757GL-P](#) [MIC23356YFT-TR](#) [LD8116CGL](#) [HG2269M/TR](#) [OB2269](#) [XD3526](#) [U6215A](#) [U6215B](#)  
[U6620S](#) [LTC3412IFE](#) [LT1425IS](#) [MAX25203BATJA/VY+](#) [MAX77874CEWM+](#) [XC9236D08CER-G](#) [MP3416GJ-P](#) [MP5461GC-Z](#)  
[MPQ4415AGQB-Z](#) [MPQ4590GS-Z](#) [MAX38640BENT18+T](#) [MAX77511AEWB+](#) [MAX20406AFOD/VY+](#)