

RAA214023

Ultra Low Noise, High PSRR, LDO

The RAA214023 is an ultra low-noise, high-PSRR, low-dropout voltage regulator. The LDO operates from an input voltage range of 2.7V to 5.5V and can source a maximum 2A load. The output voltage can be programmed from 0.8V to 3.95V by means of the PCB layout, eliminating the need for traditional external feedback resistors. To extend the output voltage range up to 5.5V- $V_{DROPOUT}$ external feedback resistors can still be used.

The RAA214023 has a low output noise of $6.5\mu V_{RMS}$ typical and high PSRR, making it well suited for post-regulation in low-noise applications.

The operating quiescent current is typically $195\mu A$ and drops to a couple nanoamps typical when in shutdown making it great for portable applications.

The LDO features $\pm 1.75\%$ output voltage accuracy (over line, load, and temperature), input UVLO with hysteresis, enable control, internal current limit, thermal shutdown protection with hysteresis, power-good indication, and fast start-up.

The device is stable with a minimum $22\mu F$ ceramic output capacitor and is available in a 20 Ld $3.5mm \times 3.5mm$ or $5mm \times 5mm$ QFN package.

Applications

- High Speed Analog: VCO, ADC, DAC, LVDS
- Clock and Timing
- RF and Wireless
- IoT and Smart Utilities
- 4G and 5G Telecom

Features

- Input Voltage Range: 2.7V to 5.5V
- Max Output Current: 2A
- Max dropout voltage: 567mV at 2A and 3.3 VOUT.
- Low RMS output noise: $6.5\mu V_{RMS}$ (10Hz to 100kHz)
- Two Output Voltage Configurations:
 - Using PCB layout and voltage set pins: 0.8V to 3.95V
 - External Resistors: 0.8V to 5.5V- $V_{DROPOUT}$
- Output Noise Spectral Density:
 - $226nV/\sqrt{Hz}$ at 10Hz
 - $77nV/\sqrt{Hz}$ at 10kHz
- High PSRR $V_{HEADROOM} = 1.7V$:
 - 100kHz: 60dB at 2A and 85dB at 500mA
 - 1MHz: 51dB at 2A and 62dB at 500mA
- Output Voltage Accuracy $\pm 1.75\%$ over line, load, and temperature.
- Fast startup: $200\mu s$ at $V_{HEADROOM} = 3.7V$
- Typical shutdown current: 200nA at +125°C
- Overvoltage indication, and overcurrent and over-temperature fault protection

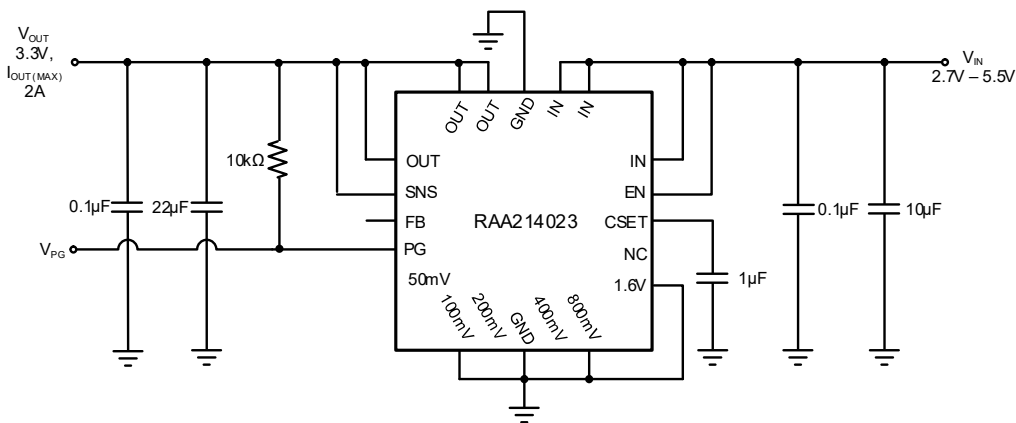

Figure 1. Typical Application Circuit

Contents

1. Overview	4
1.1 Block Diagram	4
2. Pin Information	4
2.1 Pin Assignments	4
2.2 Pin Descriptions	5
3. Specifications	6
3.1 Absolute Maximum Ratings	6
3.2 Thermal Information	6
3.3 Recommended Operation Conditions	6
3.4 Electrical Specifications	7
4. Typical Performance Curves	9
4.1 Output Noise	9
4.2 PSSR	11
4.3 Load Transient	19
4.4 Dropout Voltage	20
4.5 General Performance	22
5. Applications Information	29
5.1 Overview	29
5.2 Theory of Operation of PMOS LDOs	30
6. Functional Description	31
6.1 AC Performance	31
6.1.1 Ultra-Low Output Noise	31
6.1.2 High Power Supply Ripple Rejection	31
6.1.3 Load Transient Response	31
6.2 UVLO	32
6.3 Enable Control	32
6.4 Integrated Protection Features	33
6.4.1 Internal Current Limit (ILIM)	33
6.4.2 Thermal Protection	33
6.5 Power-Good (PG) Indication	33
6.6 DC Performance	34
6.6.1 Dropout Voltage	34
6.6.2 Output Current	34
6.7 Output Capacitor Automatic Discharge	34
6.8 Voltage Requirements	35
6.8.1 Input Voltage	35
6.9 Adjusting the Output Voltage	35
6.9.1 Voltage Set Pins	35
6.9.2 External Feedback Resistors	37
6.10 External Bypass Capacitor Selection	38
6.10.1 Input Capacitor	38
6.10.2 Output Capacitor	38
6.10.3 C _{SET} Capacitor	38
6.11 Power Dissipation and Thermals	40
6.11.1 Power Dissipation	40

6.11.2	The Junction Temperature and Thermal Resistance	40
6.12	Layout Guidelines	40
7.	SPICE Model	41
7.1	Characterization vs Simulation Results	41
8.	Package Outline Drawings	42
9.	Ordering Information	44
10.	Revision History	44

1. Overview

1.1 Block Diagram

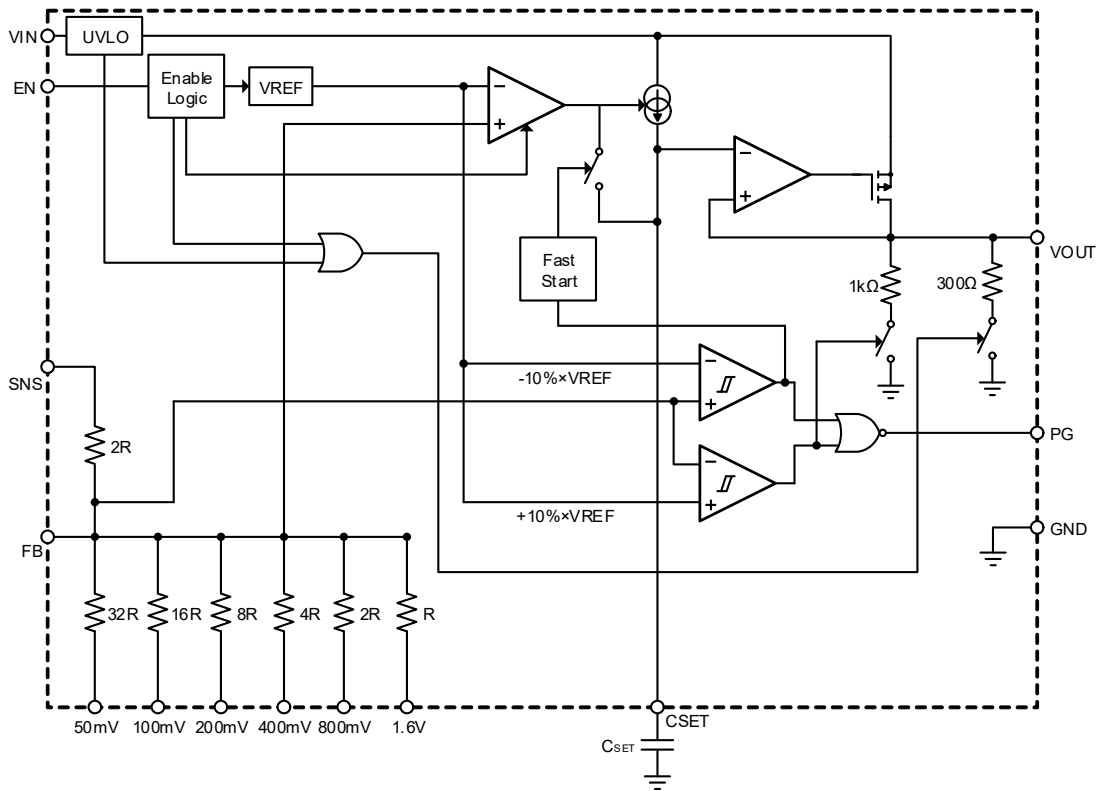
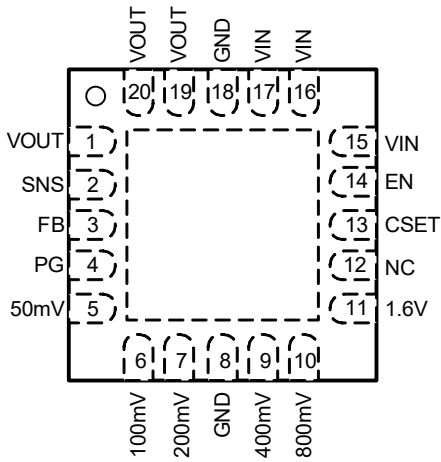

Figure 2. Block Diagram

2. Pin Information

2.1 Pin Assignments



5×5 QFN
Top View

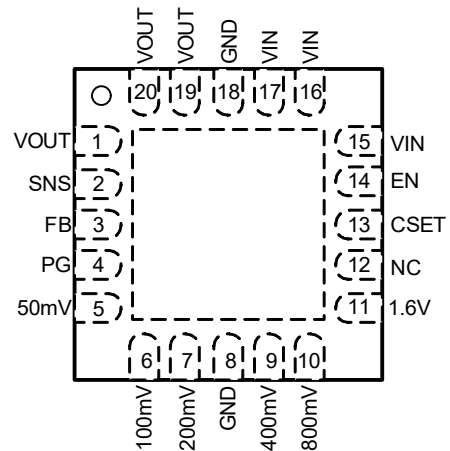

3.5×3.5 QFN
Top View

2.2 Pin Descriptions

Pin Number	Pin Name	Description
15, 16, 17	VIN	VIN are the input voltage pins that supply power to the regulator. The RAA214023 requires a minimum ceramic input bypass capacitor of 10 μ F.
1, 19, 20	VOUT	VOUT are the output pins that supply power to the load. For stable operation over the full temperature range, input range, output range, and load extremes, a minimum 22 μ F capacitor is required from VOUT to GND.
2	SNS	SNS is the output voltage sense pin. Connect this pin to the VOUT pin if the Voltage Set pins are used to program the output voltage using the PCB layout. Otherwise, float this pin if external feedback resistors are used.
3	FB	FB is the voltage feedback pin. The FB pin is internally set to 0.8V (\pm 1.75%) using the band gap circuitry. The voltage divider formed around this pin with either the internal or external feedback resistors sets the LDO output voltage. See External Feedback Resistors for more information on setting the output voltage.
4	PG	PG is the power good pin. It is an open-drain logic output that can monitor the output voltage. This pin is OPEN when VOUT is within 90% and 110% of the target output value. When the output voltage is outside of this range, the pin pulls low, indicating a fault is detected. If this pin is used, Renesas recommends tying this pin high with a 10k Ω - 100k Ω pull-up resistor to ensure a proper logic high level. If this pin is not being used, this pin can be left floating.
5	50mV	These are the Voltage Set pins. These pins can be either grounded or left floating. Connecting any pin to ground increases the output voltage by the value of the pin name. With all the pins left floating, the output voltage is typically 0.8V. With all the pins grounded, the output voltage is typically 3.95V.
6	100mV	
7	200mV	
9	400mV	
10	800mV	
11	1.6V	
8, 18	GND	GND is the ground pin. Pin must be tied to ground.
12	NC	No connection. Float this pin.
13	CSET	CSET pin is the noise reduction pin. To optimize the output noise and PSRR performance, connect a 1 μ F capacitor between this pin and ground, as close as possible to the device. Larger capacitor values can be used to increase the output voltage start-up time.
14	EN	EN is the ENABLE pin. When set to low, it disables the LDO and setting it high enables the LDO. IMPORTANT: This pin must not be left floating. Instead, tie it to the VIN pins for automatic enabling.
EPAD	-	EPAD is the exposed pad on the bottom of the package. To ensure proper electrical and thermal performance, solder the exposed pad to the PCB ground plane and tie it directly to the ground Pin 8 and Pin 18. See Layout Guidelines for more layout guidelines for this pin.

3. Specifications

3.1 Absolute Maximum Ratings

CAUTION: Do not operate at or near the maximum ratings listed for extended periods of time. Exposure to such conditions can adversely impact product reliability and result in failures not covered by warranty.

Parameter	Minimum	Maximum	Unit
VIN, VOUT,		+6.5	V
SNS, FB, PG, 50mV, 100mV, 200mV, 400mV, 800mV, 1.6V, CSET, EN		+6.5	V
ESD Rating	Value		Unit
Human Body Model (Tested per JS-001-2017)	3		kV
Charged Device Model (Tested per JS-002-2018)	1.25		kV
Latch-Up (Tested per JESD78E; Class 2, Level A)	100		mA

3.2 Thermal Information

Thermal Resistance (Typical)	θ_{JA} (°C/W)[1]	θ_{JC} (°C/W)[2]
20 Ld 3.5 × 3.5 QFN Package	46	8
20 Ld 5 × 5 QFN Package	39	10

- θ_{JA} is measured in free air with the component mounted on a high-effective thermal conductivity test board with direct attach features. See [TB379](#).
- For θ_{JC} , the case temperature location is the center of the exposed metal pad on the package underside.

Parameter	Minimum	Maximum	Unit
Maximum Junction Temperature		+150	°C
Maximum Storage Temperature Range	-65	+150	°C
Pb-Free Reflow Profile	see TB493		

3.3 Recommended Operation Conditions

Parameter	Minimum	Maximum	Unit
Supply Voltage, VIN	2.7	5.5	V
Ambient Temperature	-40	+125	°C
Output Voltage	0.8	VIN - VDO	V

3.4 Electrical Specifications

Default test conditions unless otherwise specified: $T_J = -40^{\circ}\text{C}$ to $+125^{\circ}\text{C}$, $V_{IN} = V_{OUT} + 0.5\text{V}$ or 2.7V whichever is greater, $C_{IN} = 10\mu\text{F}$, $C_{OUT} = 22\mu\text{F}$, unless otherwise noted. Typical values are at $T_J = +25^{\circ}\text{C}$. **Boldface limits apply across the operating temperature range (-40°C to +125°C).**

Parameters	Symbol	Conditions	Min ^[1]	Typ.	Max ^[1]	Unit
Power Supply						
Input Voltage Range	V_{IN}		2.7		5.5	V
Input Supply UVLO	V_{IN_UVLO}	V_{IN} UVLO rising	2.2	2.3	2.45	V
Input Supply UVLO Hysteresis	$V_{IN_UVLO_HYS}$	V_{IN} UVLO Hysteresis	0.03	0.23	0.3	V
Output Current	I_{OUT}				2.0	A
V_{IN} Quiescent Current	$I_Q (V_{IN})$	$V_{OUT} = 3.3\text{V}$, $V_{IN} = 5\text{V}$	50	195	300	μA
Ground Pin Current in Shutdown	I_{SHDN}	$V_{EN} = 0\text{V}$, $T_J = +125^{\circ}\text{C}$		200		nA
Output						
Output Voltage Range		$V_{IN} = 2.7\text{V}$ to 5.5V	0.8		VIN -VDO	V
FB voltage			0.786	0.8	0.814	V
Output Voltage Accuracy		Initial at $I_{OUT} = 10\text{mA}$, $T_J = 25^{\circ}\text{C}$	-1.5		1.5	%
		Initial at $I_{OUT} = 10\text{mA}$ to 2A	-1.75		1.75	%
Line Regulation		$V_{IN} = 2.7\text{V}$ to 5.5V $I_{OUT} = 5\text{mA}$		0.1		%/V
Load Regulation		$I_{OUT} = 10\text{mA}$ to 2A		0.03		%/A
Dropout Voltage	VDO	$V_{IN} = 3.3\text{V}$, $I_{OUT} = 2\text{A}$		420	570	mV
Internal Current Limit		$V_{IN} = 2.7\text{V}$ to 5.5V , $V_{OUT} = 0\text{V}$.		3.3		A
Start-Up Time		$V_{IN} = 5.5\text{V}$, $V_{OUT} = 1.8\text{V}$, $I_{OUT} = 2\text{A}$, $C_{SET} = 1\mu\text{F}$		200		μs
Thermal Shutdown		Rising		155		$^{\circ}\text{C}$
Thermal Shutdown Hysteresis				10		$^{\circ}\text{C}$
Noise						
Noise Spectral Density		$I_{LOAD} = 2\text{A}$, Frequency = 10Hz, $C_{OUT} = 22\mu\text{F}$, $C_{SET} = 1\mu\text{F}$ $V_{OUT} = 3.3\text{V}$		226		$\text{nV}/\sqrt{\text{Hz}}$
		$I_{LOAD} = 2\text{A}$, Frequency = 100Hz, $C_{OUT} = 22\mu\text{F}$, $C_{SET} = 1\mu\text{F}$ $V_{OUT} = 3.3\text{V}$		77		$\text{nV}/\sqrt{\text{Hz}}$
		$I_{LOAD} = 2\text{A}$, Frequency = 1kHz, $C_{OUT} = 22\mu\text{F}$, $C_{SET} = 1\mu\text{F}$ $V_{OUT} = 3.3\text{V}$		32		$\text{nV}/\sqrt{\text{Hz}}$
		$I_{LOAD} = 2\text{A}$, Frequency = 10kHz, $C_{OUT} = 22\mu\text{F}$, $C_{SET} = 1\mu\text{F}$ $V_{OUT} = 3.3\text{V}$		20		$\text{nV}/\sqrt{\text{Hz}}$
Output RMS Noise		$I_{LOAD} = 2\text{A}$, Frequency = 10Hz to 100kHz, $C_{OUT} = 22\mu\text{F}$, $C_{SET} = 1\mu\text{F}$ $V_{OUT} = 3.3\text{V}$		6.5		μV_{RMS}

Default test conditions unless otherwise specified: $T_J = -40^{\circ}\text{C}$ to $+125^{\circ}\text{C}$, $V_{IN} = V_{OUT} + 0.5\text{V}$ or 2.7V whichever is greater, $C_{IN} = 10\mu\text{F}$, $C_{OUT} = 22\mu\text{F}$, unless otherwise noted. Typical values are at $T_J = +25^{\circ}\text{C}$. **Boldface limits apply across the operating temperature range (-40°C to $+125^{\circ}\text{C}$).** (Cont.)

Parameters	Symbol	Conditions	Min ^[1]	Typ.	Max ^[1]	Unit
PSRR						
PSRR	PSRR1	$V_{RIPPLE} = 500\text{mVP-P}$, $f_{RIPPLE} = 120\text{Hz}$, $I_{LOAD} = 2\text{A}$, $C_{OUT} = 22\mu\text{F}$, $C_{SET} = 1\mu\text{F}$, $V_{IN} = 5\text{V}$, $V_{OUT} = 3.3\text{V}$		84		dB
	PSRR2	$V_{RIPPLE} = 150\text{mVP-P}$, $f_{RIPPLE} = 10\text{kHz}$, $I_{LOAD} = 2\text{A}$, $C_{OUT} = 22\mu\text{F}$, $C_{SET} = 1\mu\text{F}$, $V_{IN} = 5\text{V}$, $V_{OUT} = 3.3\text{V}$		81		dB
	PSRR3	$V_{RIPPLE} = 150\text{mVP-P}$, $f_{RIPPLE} = 100\text{kHz}$, $I_{LOAD} = 2\text{A}$, $C_{OUT} = 22\mu\text{F}$, $C_{SET} = 1\mu\text{F}$, $V_{IN} = 5\text{V}$, $V_{OUT} = 3.3\text{V}$		64		dB
	PSRR4	$V_{RIPPLE} = 150\text{mVP-P}$, $f_{RIPPLE} = 1\text{MHz}$, $I_{LOAD} = 2\text{A}$, $C_{OUT} = 22\mu\text{F}$, $C_{SET} = 1\mu\text{F}$, $V_{IN} = 5\text{V}$, $V_{OUT} = 3.3\text{V}$		52		dB
EN Input Pin						
EN Input Voltage threshold	EN_VTH		1.2	1.25	1.33	V
EN Threshold Hysteresis	EN_Hys		0.03	0.05	0.1	V
EN Leakage		EN = 5.5V		32	100	nA
PG Output Pin						
PG V_{OUT} Overvoltage	PG_VTH_OV	VOUT OV		+8.2		%
PG V_{OUT} Undervoltage	PG_VTH_UV	VOUT UV		-11.5		%
PG Threshold Hysteresis	PG_Hys_OV_UV	For both OV and UV		-1.4		%
PG Delay		V_{OUT} Rising	0.05	0.17	0.25	μs
		V_{OUT} Falling	0.7	1.2	1.9	μs
PG VOL	PG_VOL	IPG = 1mA		130	250	mV

1. Parameters with MIN and/or MAX limits are 100% tested at $+25^{\circ}\text{C}$, unless otherwise specified. Temperature limits established by characterization and are not production tested.

4. Typical Performance Curves

4.1 Output Noise

$C_{SET} = 1\mu\text{F}$, $C_{OUT} = 22\mu\text{F}$, unless otherwise stated.

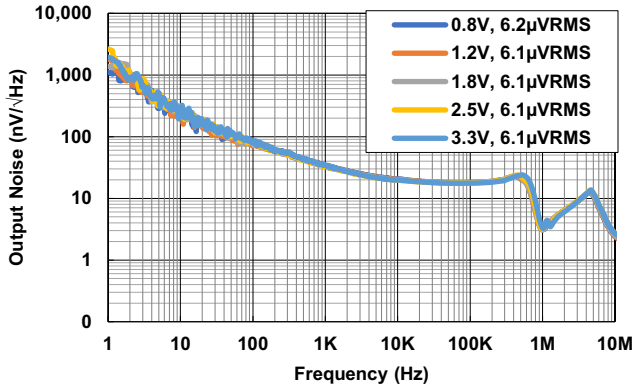

Figure 3. Output Noise vs Frequency for Various V_{OUT} ($V_{IN} = V_{OUT} + 2V$, $I_{OUT} = 500\text{mA}$)

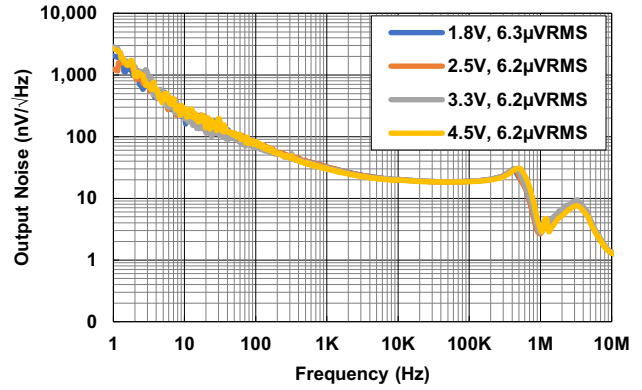

Figure 4. Output Noise vs Frequency for Various V_{OUT} ($V_{IN} = V_{OUT} + 1V$, $I_{OUT} = 2A$)

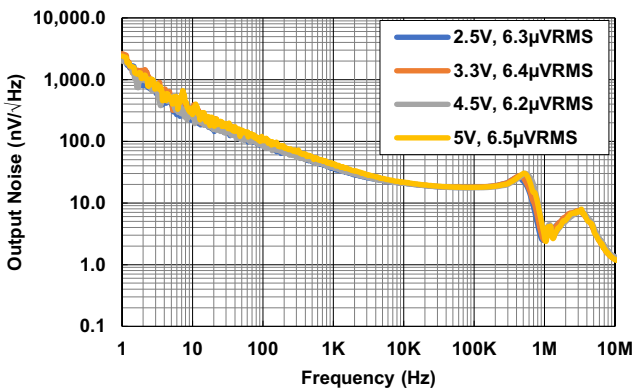

Figure 5. Output Noise vs Frequency for Various V_{OUT} ($V_{IN} = V_{OUT} + 500\text{mV}$, $I_{OUT} = 500\text{mA}$)

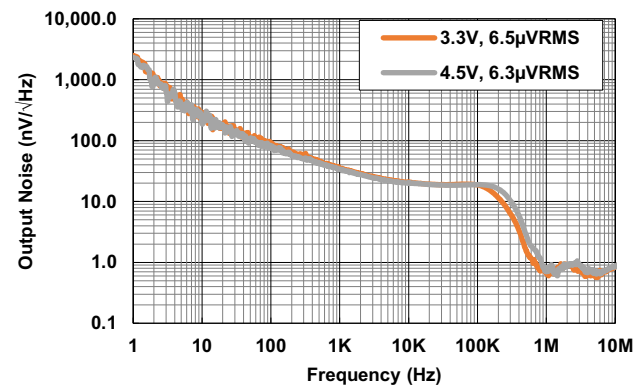

Figure 6. Output Noise vs Frequency for Various V_{OUT} ($V_{IN} = V_{OUT} + 500\text{mV}$, $I_{OUT} = 2A$)

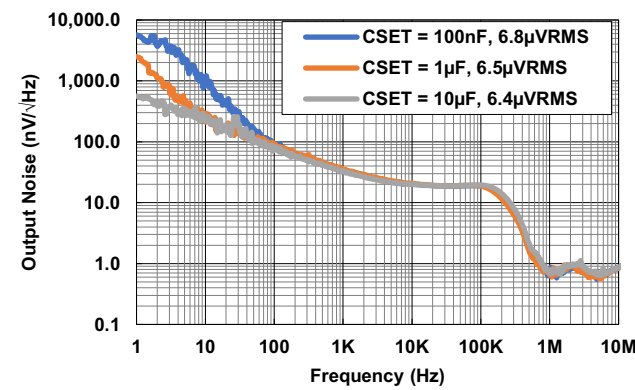

Figure 7. Output Noise vs Frequency for Various C_{SET} ($V_{IN} = V_{OUT} + 500\text{mV}$, $I_{OUT} = 2A$)

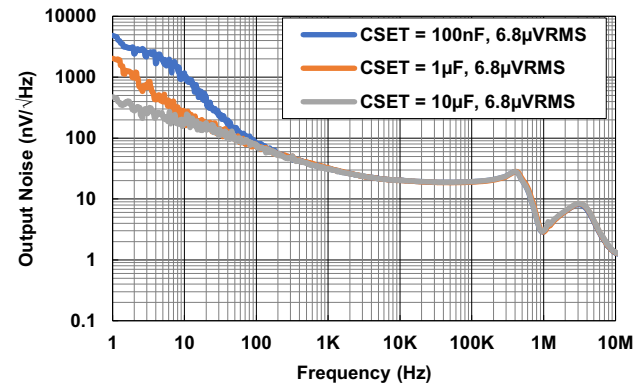

Figure 8. Output Noise vs Frequency for Various C_{SET} ($V_{IN} = V_{OUT} + 500\text{mV}$, $I_{OUT} = 500\text{mA}$)

$C_{SET} = 1\mu F$, $C_{OUT} = 22\mu F$, unless otherwise stated. (Cont.)

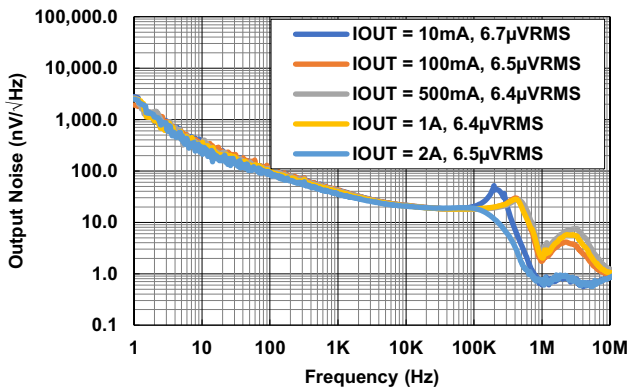

Figure 9. Output Noise vs Frequency for Various I_{OUT} ($V_{IN} = V_{OUT} + 500mV$, $I_{OUT} = 2A$)

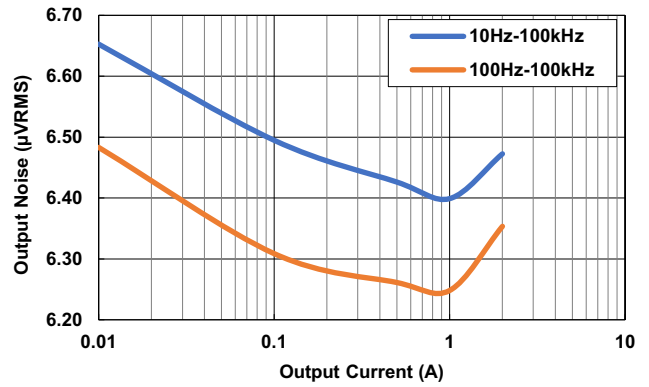

Figure 10. Integrated Output Noise vs I_{OUT} for Various Bandwidths ($V_{IN} = V_{OUT} + 500mV$, $I_{OUT} = 2A$)

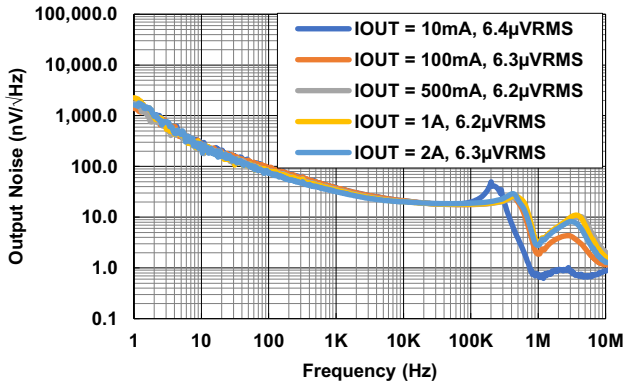

Figure 11. Output Noise vs Frequency for Various I_{OUT} ($V_{IN} = V_{OUT} + 1V$, $I_{OUT} = 2A$)

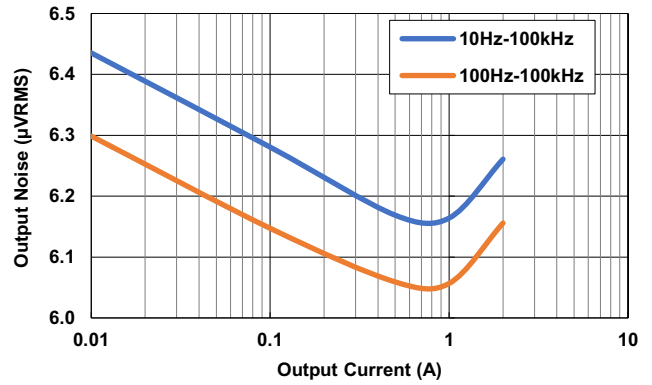

Figure 12. Integrated Output Noise vs I_{OUT} for Various Bandwidths ($V_{IN} = V_{OUT} + 1V$, $I_{OUT} = 2A$)

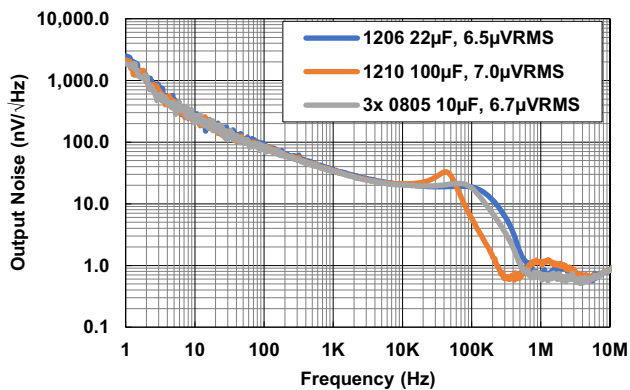

Figure 13. Output Noise vs Frequency for Various C_{OUT} ($V_{IN} = V_{OUT} + 500mV$, $I_{OUT} = 2A$)

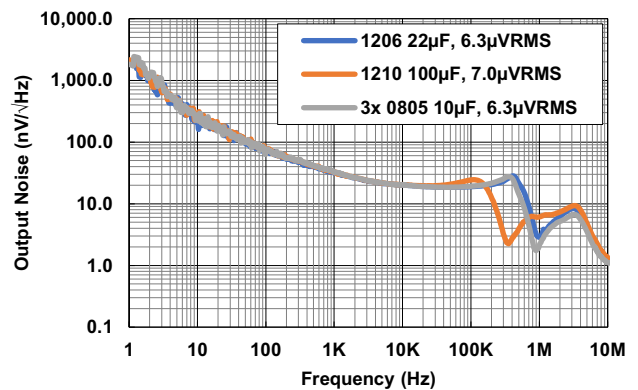

Figure 14. Output Noise vs Frequency for Various C_{OUT} ($V_{IN} = V_{OUT} + 1V$, $I_{OUT} = 2A$)

4.2 PSSR

$C_{SET} = 1\mu F$, $C_{OUT} = 22\mu F$, unless otherwise stated.

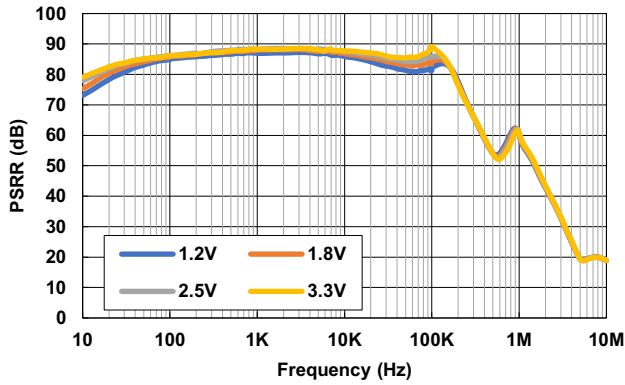

Figure 15. PSRR vs Frequency for Various V_{OUT}
($V_{IN} = V_{OUT} + 2V$, $I_{OUT} = 500mA$)

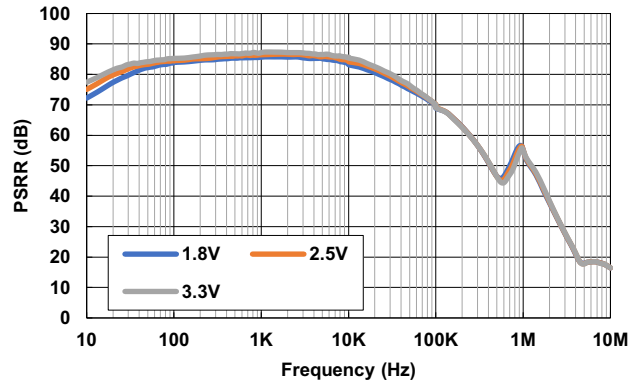

Figure 16. PSRR vs Frequency for Various V_{OUT}
($V_{IN} = V_{OUT} + 1.2V$, $I_{OUT} = 500mA$)

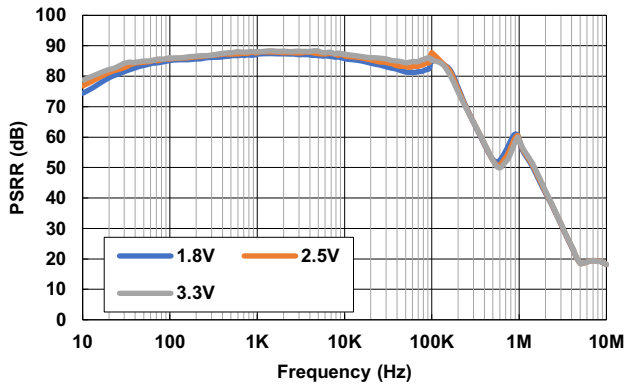

Figure 17. PSRR vs Frequency for Various V_{OUT}
($V_{IN} = V_{OUT} + 1.7V$, $I_{OUT} = 500mA$)

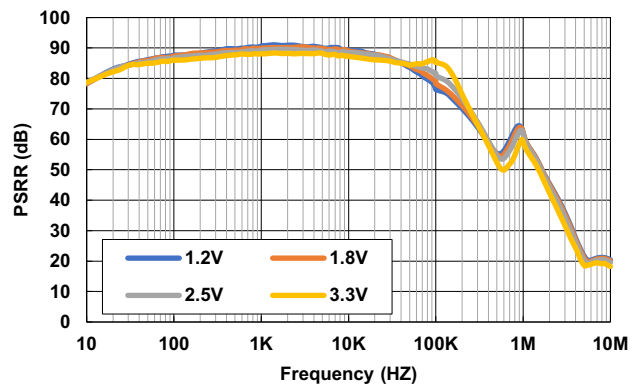

Figure 18. PSRR vs Frequency for Various V_{OUT}
($V_{IN} = 5V$, $I_{OUT} = 500mA$)

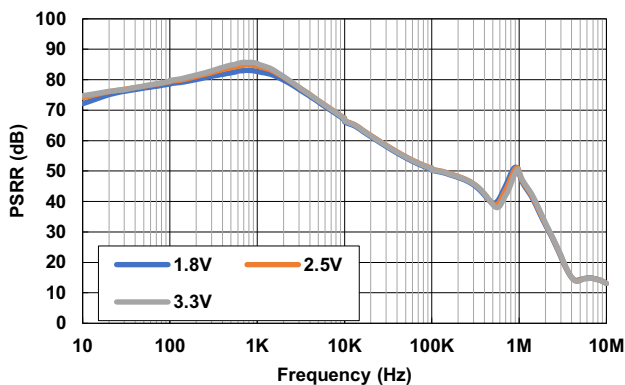

Figure 19. PSRR vs Frequency for Various V_{OUT}
($V_{IN} = V_{OUT} + 1.2V$, $I_{OUT} = 2A$)

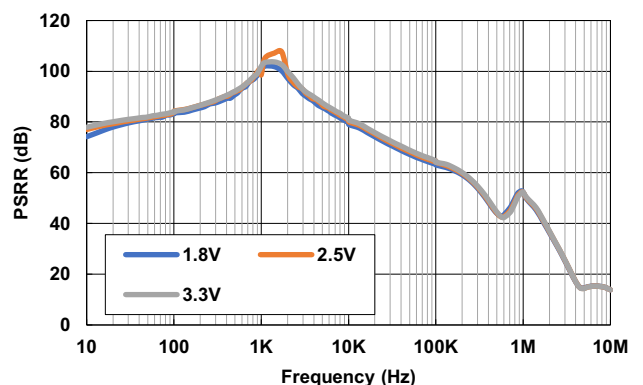

Figure 20. PSRR vs Frequency for Various V_{OUT}
($V_{IN} = V_{OUT} + 1.7V$, $I_{OUT} = 2A$)

$C_{SET} = 1\mu F$, $C_{OUT} = 22\mu F$, unless otherwise stated. (Cont.)

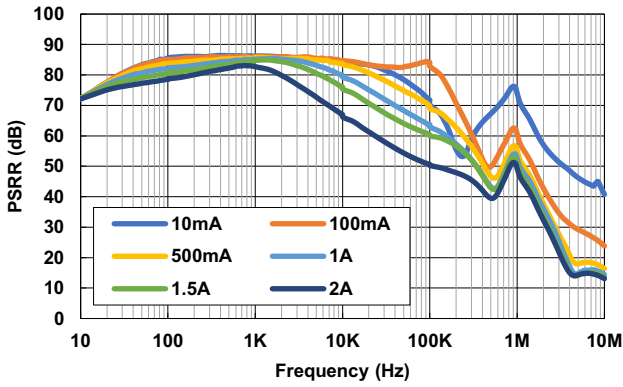

Figure 21. PSRR vs Frequency for Various I_{OUT} ($V_{IN} = 3V$, $V_{OUT} = 1.8V$)

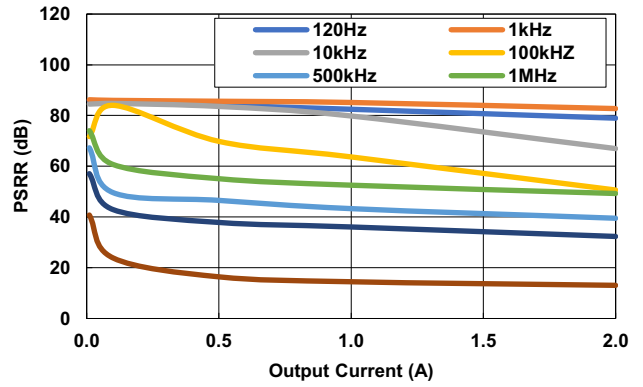

Figure 22. PSRR vs I_{OUT} for Various Frequencies ($V_{IN} = 3V$, $V_{OUT} = 1.8V$)

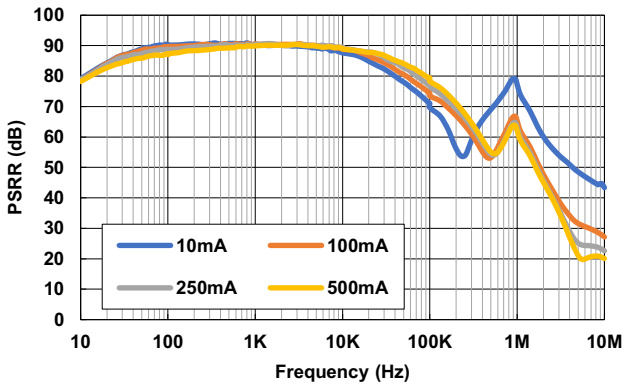

Figure 23. PSRR vs Frequency for Various I_{OUT} ($V_{IN} = 5V$, $V_{OUT} = 1.8V$)

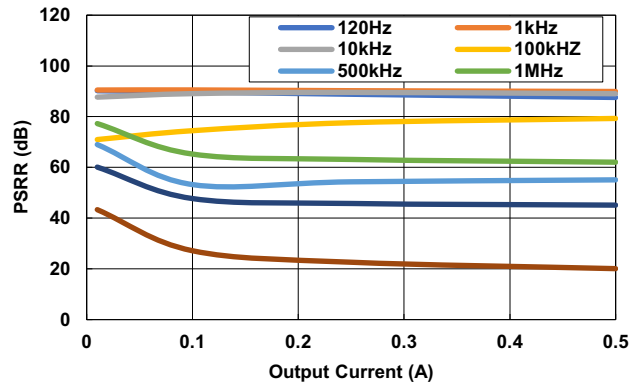

Figure 24. PSRR vs I_{OUT} for Various Frequencies ($V_{IN} = 5V$, $V_{OUT} = 1.8V$)

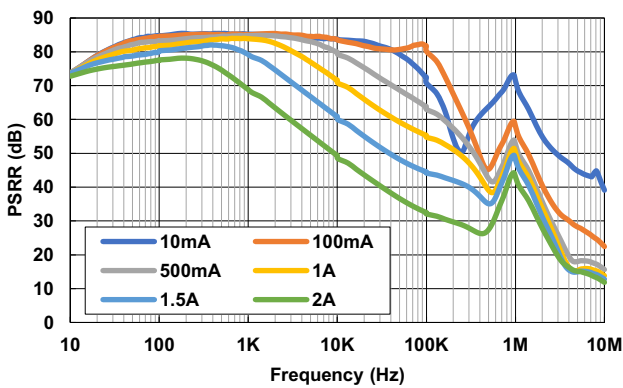

Figure 25. PSRR vs Frequency for Various I_{OUT} ($V_{IN} = 3.3V$, $V_{OUT} = 2.5V$)

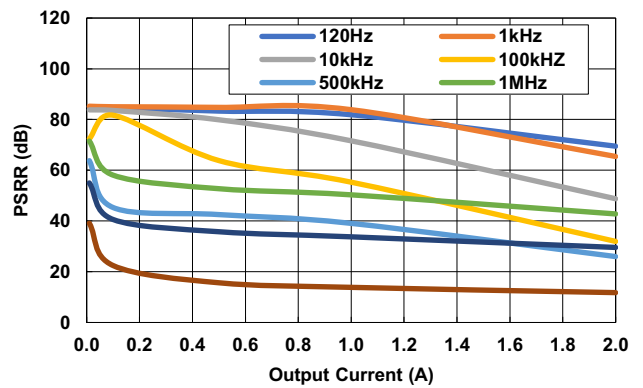

Figure 26. PSRR vs I_{OUT} for Various Frequencies ($V_{IN} = 3.3V$, $V_{OUT} = 2.5V$)

$C_{SET} = 1\mu F$, $C_{OUT} = 22\mu F$, unless otherwise stated. (Cont.)

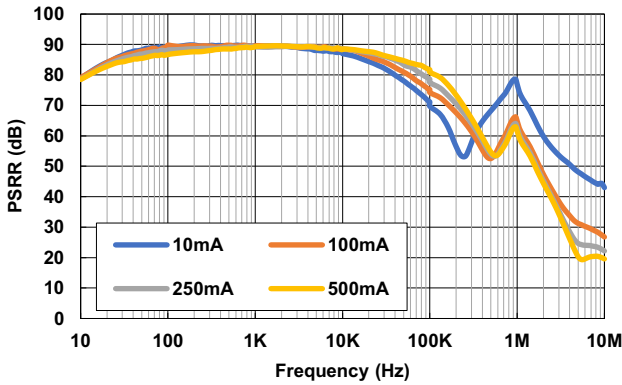

Figure 27. PSRR vs Frequency for Various I_{OUT}
($V_{IN} = 5V$, $V_{OUT} = 2.5V$)

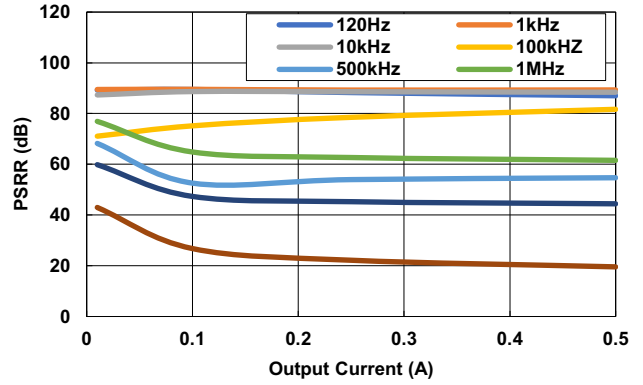

Figure 28. PSRR vs I_{OUT} for Various Frequencies
($V_{IN} = 5V$, $V_{OUT} = 2.5V$)

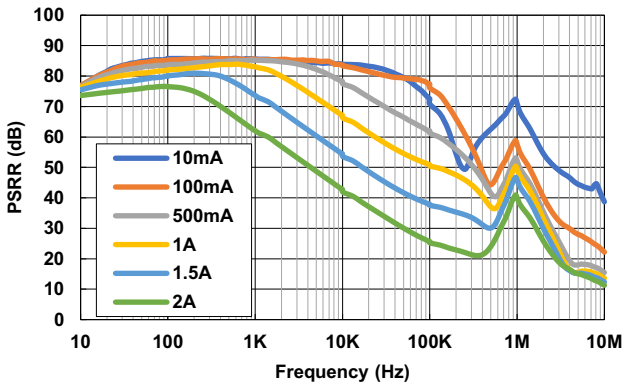

Figure 29. PSRR vs Frequency for Various I_{OUT}
($V_{IN} = 4V$, $V_{OUT} = 3.3V$)

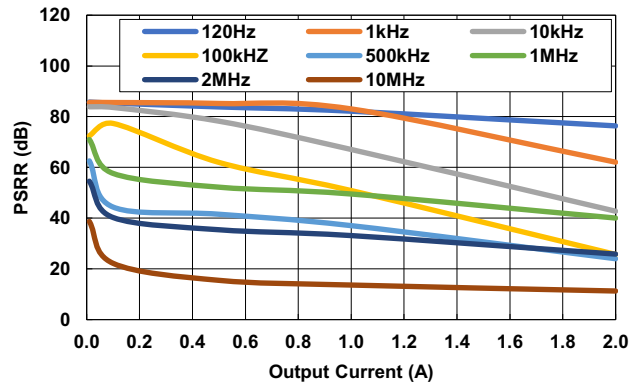

Figure 30. PSRR vs I_{OUT} for Various Frequencies
($V_{IN} = 4V$, $V_{OUT} = 3.3V$)

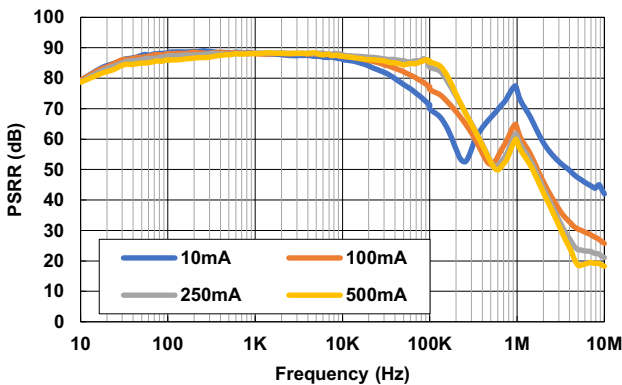

Figure 31. PSRR vs Frequency for Various I_{OUT}
($V_{IN} = 5V$, $V_{OUT} = 3.3V$)

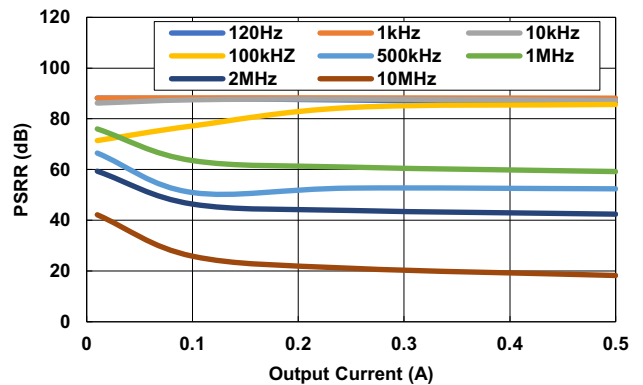

Figure 32. PSRR vs I_{OUT} for Various Frequencies
($V_{IN} = 5V$, $V_{OUT} = 3.3V$)

$C_{SET} = 1\mu F$, $C_{OUT} = 22\mu F$, unless otherwise stated. (Cont.)

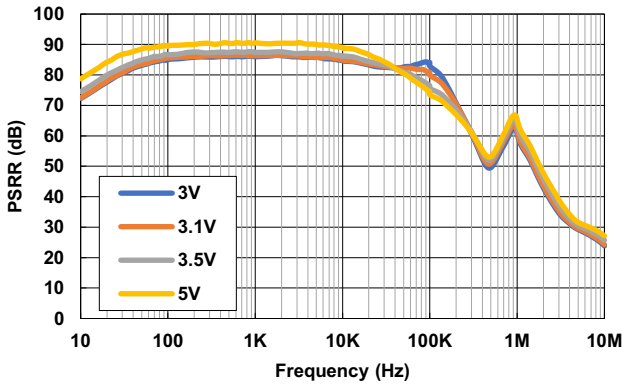

Figure 33. PSRR vs Frequency for Various V_{IN}
($V_{OUT} = 1.8V$, $I_{OUT} = 100mA$)

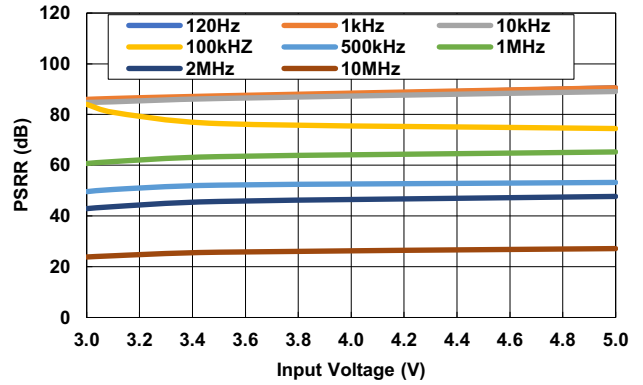

Figure 34. PSRR vs V_{IN} for Various Frequencies
($V_{OUT} = 1.8V$, $I_{OUT} = 100mA$)

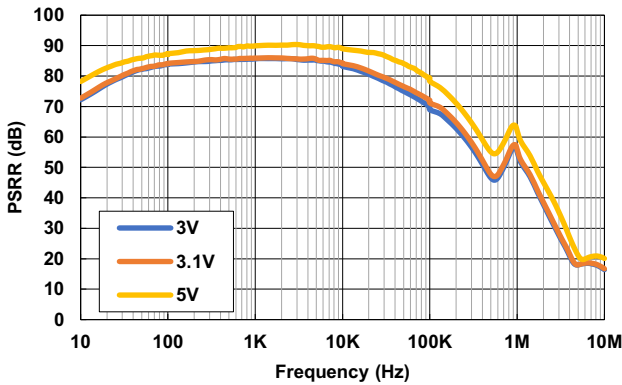

Figure 35. PSRR vs Frequency for Various V_{IN}
($V_{OUT} = 1.8V$, $I_{OUT} = 500mA$)

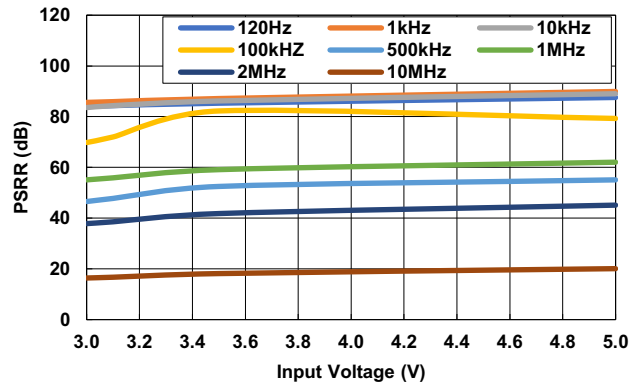

Figure 36. PSRR vs V_{IN} for Various Frequencies
($V_{OUT} = 1.8V$, $I_{OUT} = 500mA$)

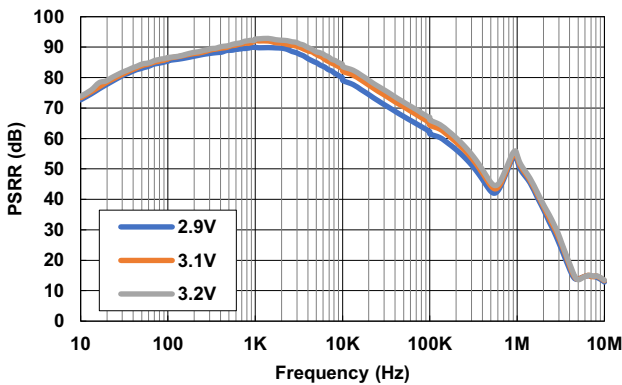

Figure 37. PSRR vs Frequency for Various V_{IN}
($V_{OUT} = 1.8V$, $I_{OUT} = 1A$)

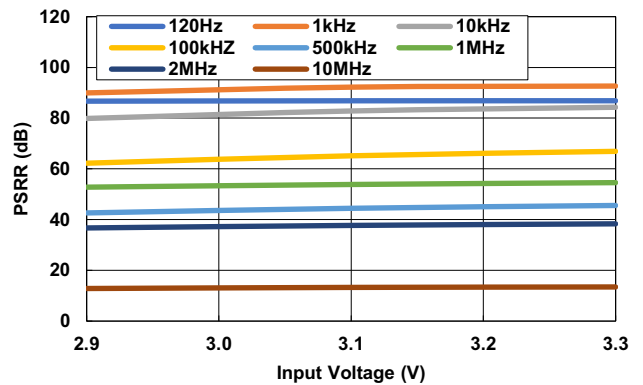

Figure 38. PSRR vs V_{IN} for Various Frequencies
($V_{OUT} = 1.8V$, $I_{OUT} = 1A$)

$C_{SET} = 1\mu F$, $C_{OUT} = 22\mu F$, unless otherwise stated. (Cont.)

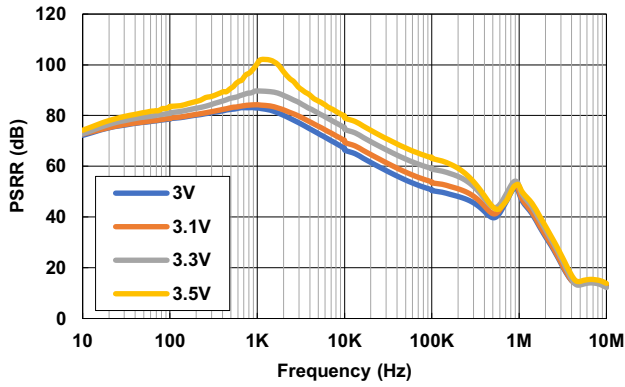

Figure 39. PSRR vs Frequency for Various V_{IN}
($V_{OUT} = 1.8V$, $I_{OUT} = 2A$)

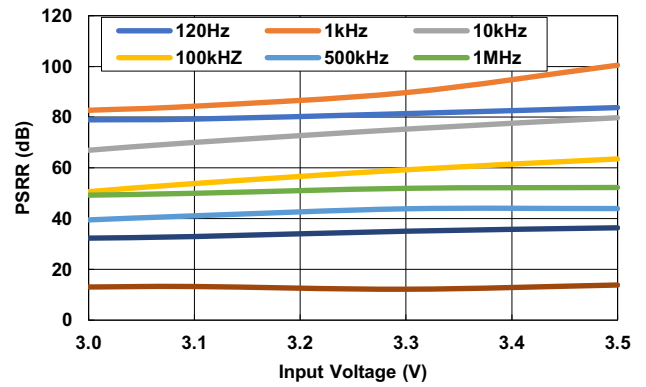

Figure 40. PSRR vs V_{IN} for Various Frequencies
($V_{OUT} = 1.8V$, $I_{OUT} = 2A$)

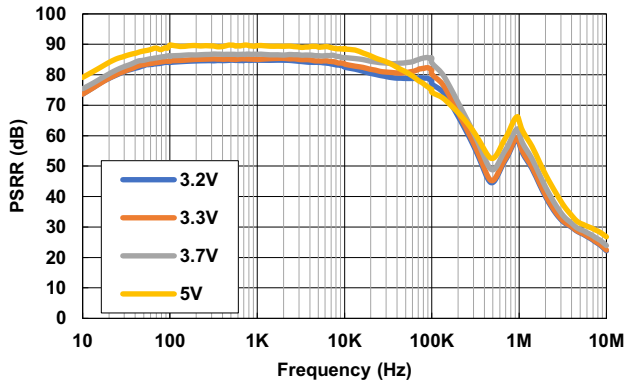

Figure 41. PSRR vs Frequency for Various V_{IN}
($V_{OUT} = 2.5V$, $I_{OUT} = 100mA$)

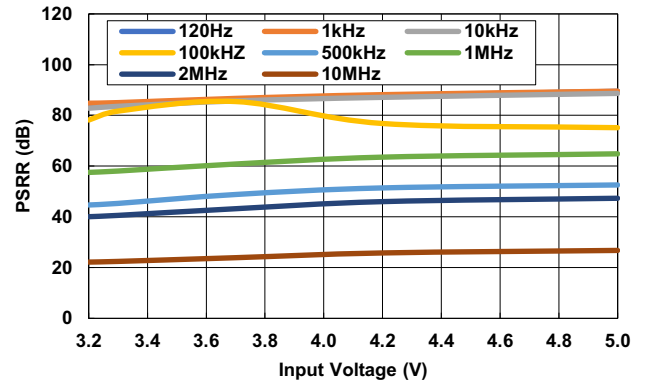

Figure 42. PSRR vs V_{IN} for Various Frequencies
($V_{OUT} = 2.5V$, $I_{OUT} = 100mA$)

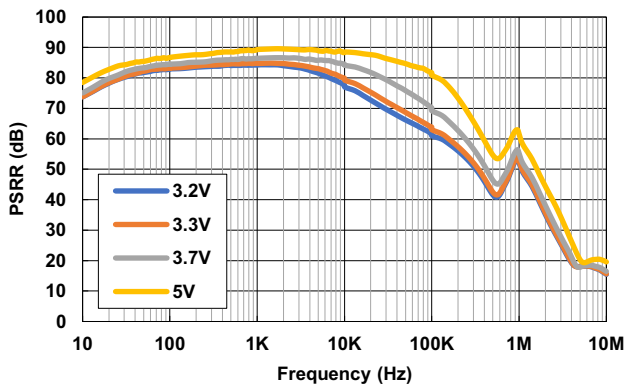

Figure 43. PSRR vs Frequency for Various V_{IN}
($V_{OUT} = 2.5V$, $I_{OUT} = 500mA$)

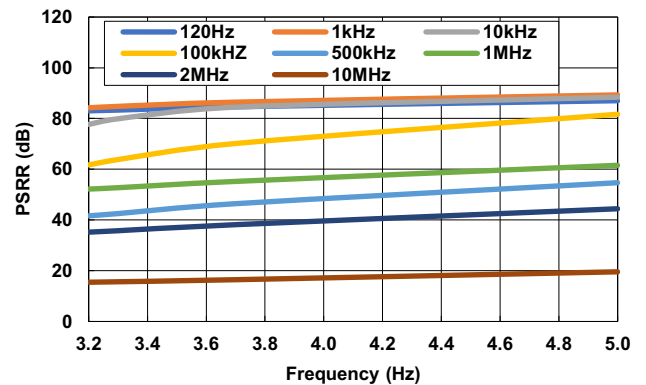

Figure 44. PSRR vs V_{IN} for Various Frequencies
($V_{OUT} = 2.5V$, $I_{OUT} = 500mA$)

$C_{SET} = 1\mu F$, $C_{OUT} = 22\mu F$, unless otherwise stated. (Cont.)

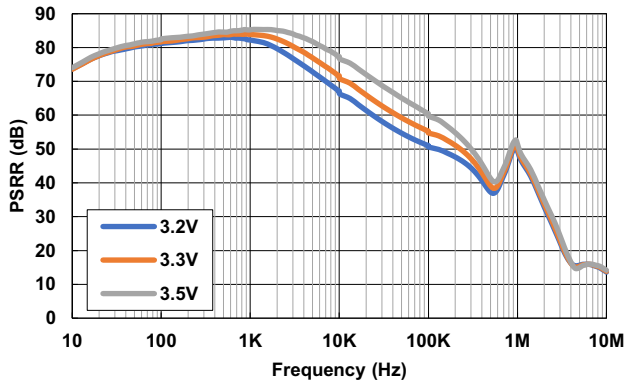

Figure 45. PSRR vs Frequency for Various V_{IN}
($V_{OUT} = 2.5V$, $I_{OUT} = 1A$)

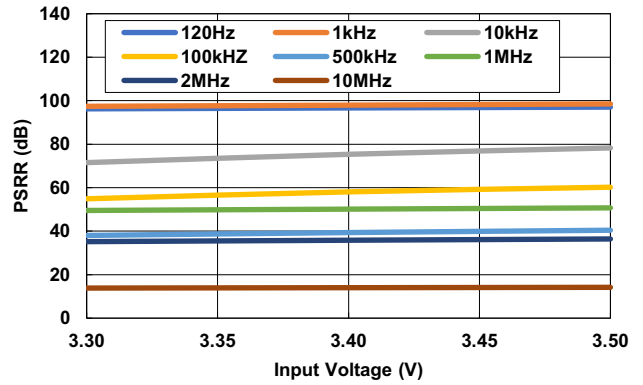

Figure 46. PSRR vs V_{IN} for Various Frequencies
($V_{OUT} = 2.5V$, $I_{OUT} = 1A$)

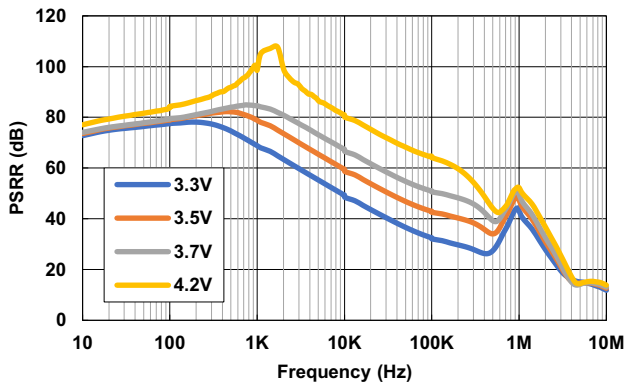

Figure 47. PSRR vs Frequency for Various V_{IN}
($V_{OUT} = 2.5V$, $I_{OUT} = 2A$)

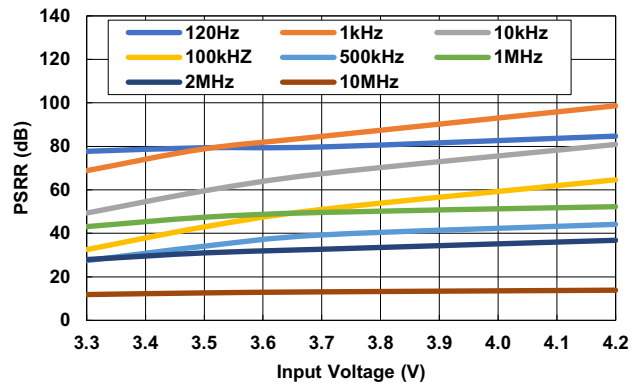

Figure 48. PSRR vs V_{IN} for Various Frequencies
($V_{OUT} = 2.5V$, $I_{OUT} = 2A$)

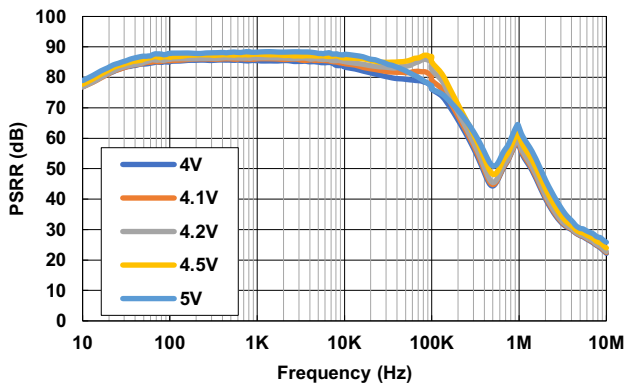

Figure 49. PSRR vs Frequency for Various V_{IN}
($V_{OUT} = 3.3V$, $I_{OUT} = 100mA$)

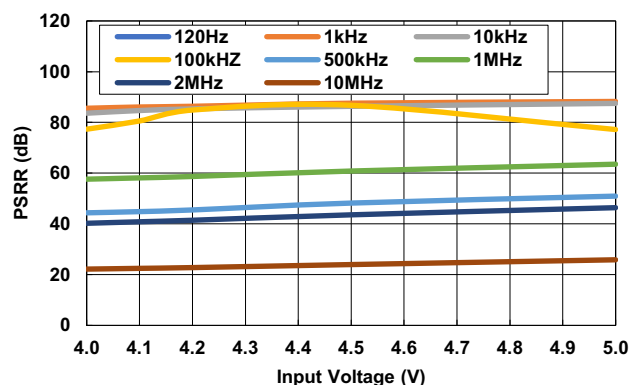

Figure 50. PSRR vs V_{IN} for Various Frequencies
($V_{OUT} = 3.3V$, $I_{OUT} = 100mA$)

$C_{SET} = 1\mu F$, $C_{OUT} = 22\mu F$, unless otherwise stated. (Cont.)

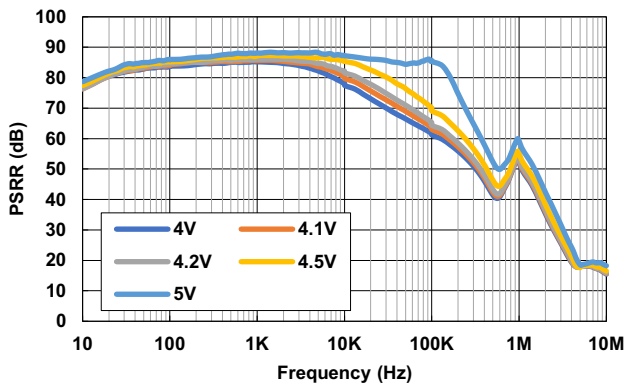

Figure 51. PSRR vs Frequency for Various V_{IN}
($V_{OUT} = 3.3V$, $I_{OUT} = 500mA$)

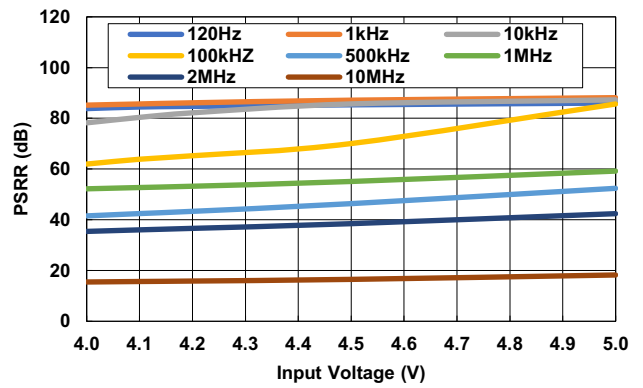

Figure 52. PSRR vs V_{IN} for Various Frequencies
($V_{OUT} = 3.3V$, $I_{OUT} = 500mA$)

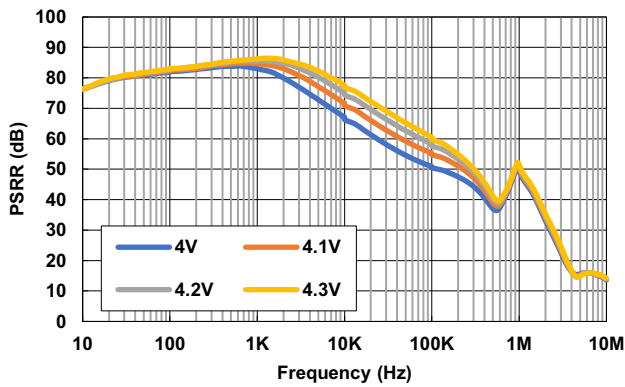

Figure 53. PSRR vs Frequency for Various V_{IN}
($V_{OUT} = 3.3V$, $I_{OUT} = 1A$)

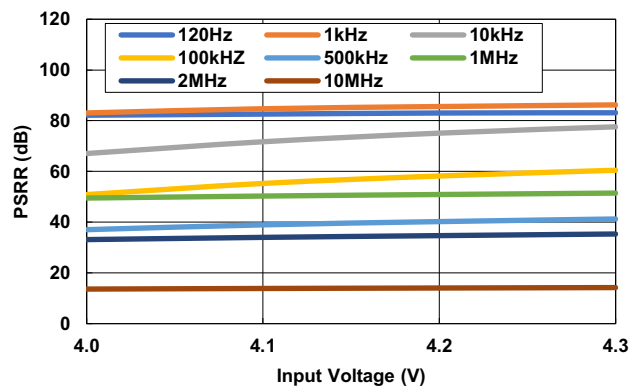

Figure 54. PSRR vs V_{IN} for Various Frequencies
($V_{OUT} = 3.3V$, $I_{OUT} = 1A$)

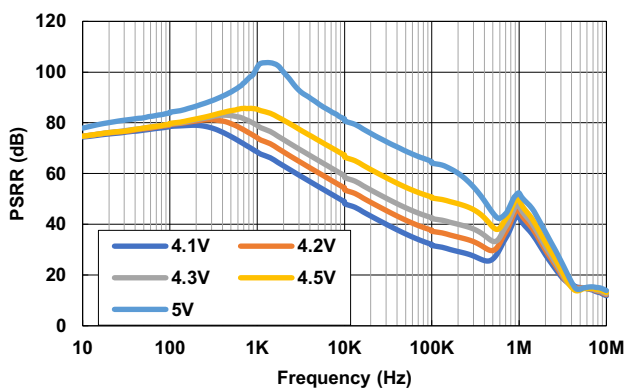

Figure 55. PSRR vs Frequency for Various V_{IN}
($V_{OUT} = 3.3V$, $I_{OUT} = 2A$)

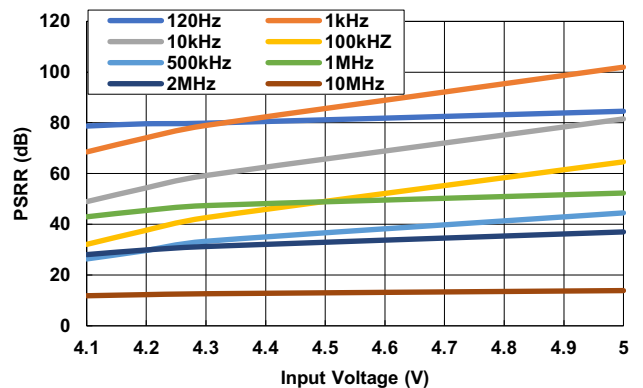

Figure 56. PSRR vs V_{IN} for Various Frequencies
($V_{OUT} = 3.3V$, $I_{OUT} = 2A$)

$C_{SET} = 1\mu F$, $C_{OUT} = 22\mu F$, unless otherwise stated. (Cont.)

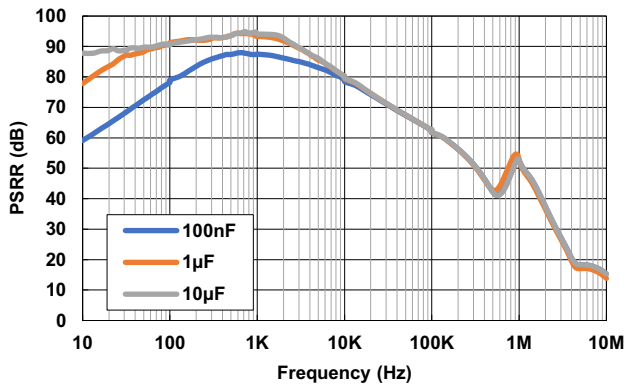

Figure 57. PSRR vs Frequency for Various C_{SET}
($V_{IN} = 4V$, $V_{OUT} = 3.3V$, $I_{OUT} = 500mA$)

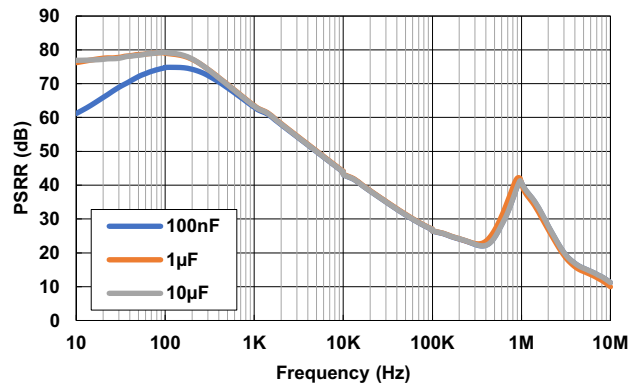

Figure 58. PSRR vs Frequency for Various C_{SET}
($V_{IN} = 4V$, $V_{OUT} = 3.3V$, $I_{OUT} = 2A$)

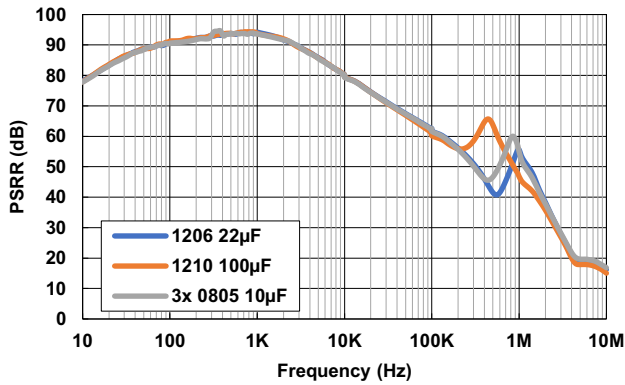

Figure 59. PSRR vs Frequency for Various C_{OUT}
($V_{IN} = 4V$, $V_{OUT} = 3.3V$, $I_{OUT} = 500mA$)

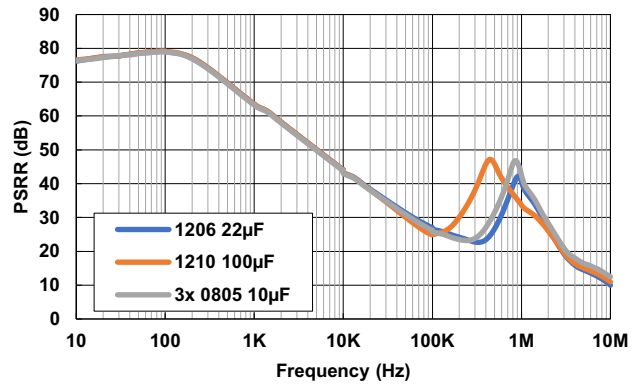

Figure 60. PSRR vs Frequency for Various C_{OUT}
($V_{IN} = 4V$, $V_{OUT} = 3.3V$, $I_{OUT} = 2A$)

4.3 Load Transient

$C_{SET} = 1\mu F$, $C_{OUT} = 22\mu F$, unless otherwise stated.

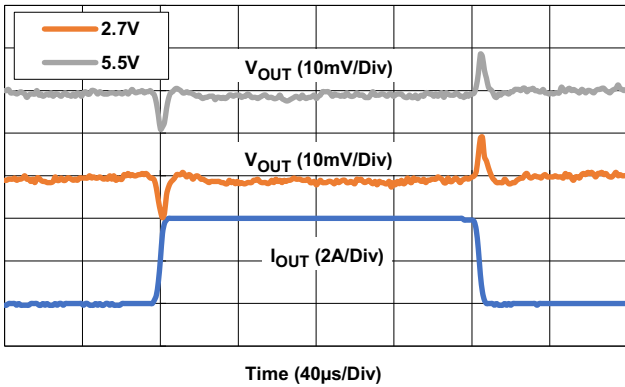

Figure 61. Load Transient Response for Various V_{IN} ($V_{OUT} = 1.8V$, $\Delta I_{OUT} = 100mA$ to $2A$ at $500mA/\mu s$)

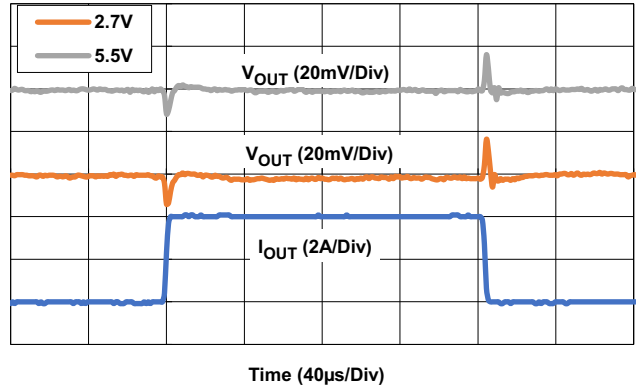

Figure 62. Load Transient Response for Various V_{IN} ($V_{OUT} = 1.8V$, $\Delta I_{OUT} = 100mA$ to $2A$ at $1A/\mu s$)

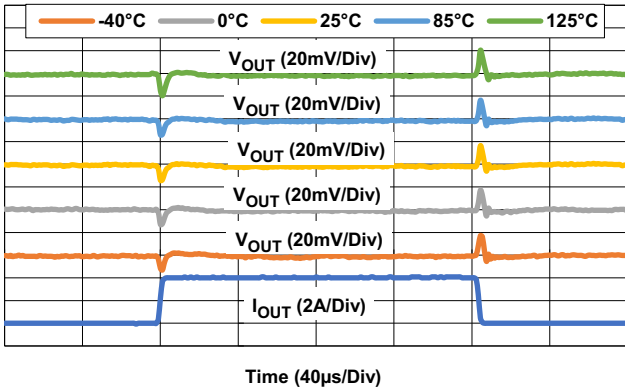

Figure 63. Load Transient Response for Various Temperatures ($V_{OUT} = 2.7V$, $\Delta I_{OUT} = 100mA$ to $2A$ at $1A/\mu s$)

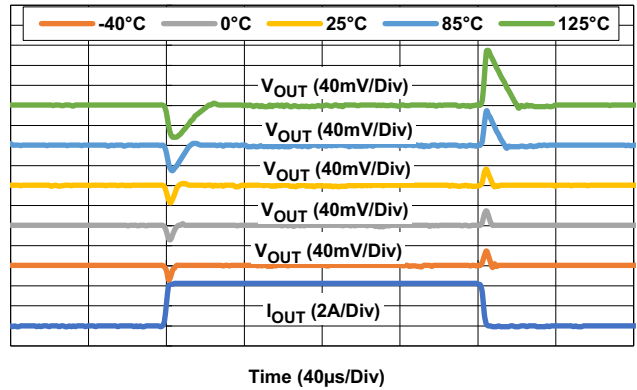

Figure 64. Load Transient Response for Various Temperatures ($V_{IN} = 3.8V$, $V_{OUT} = 3.3V$, $\Delta I_{OUT} = 100mA$ to $2A$ at $1A/\mu s$)

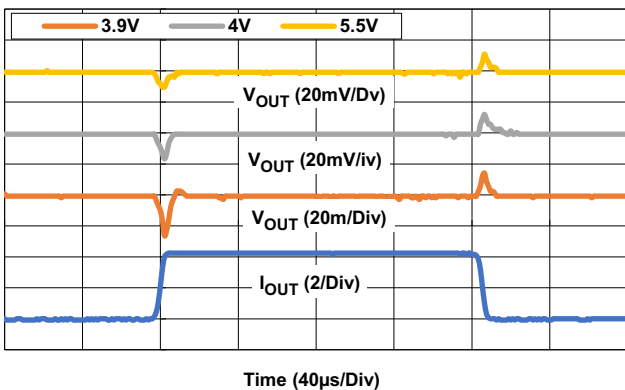

Figure 65. Load Transient Response for Various V_{IN} ($V_{OUT} = 3.3V$, $\Delta I_{OUT} = 100mA$ to $2A$ at $500mA/\mu s$)

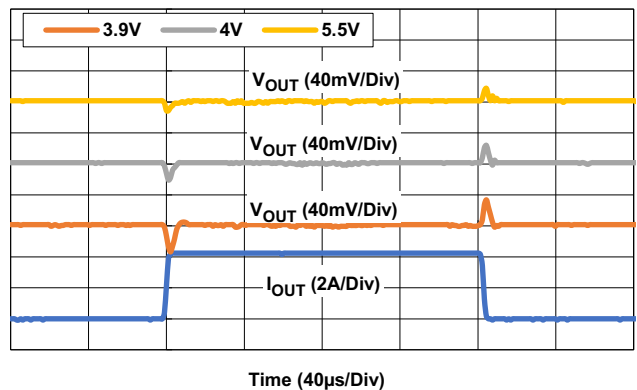

Figure 66. Load Transient Response for Various V_{IN} ($V_{OUT} = 3.3V$, $\Delta I_{OUT} = 100mA$ to $2A$ at $1A/\mu s$)

4.4 Dropout Voltage

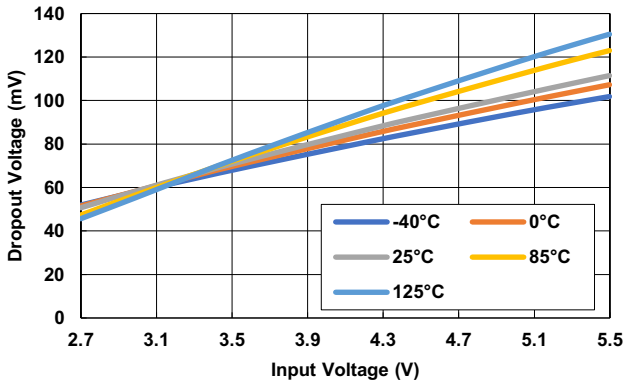

Figure 67. Dropout Voltage vs Input Voltage for Various Temperatures (I_{OUT} = 100mA)

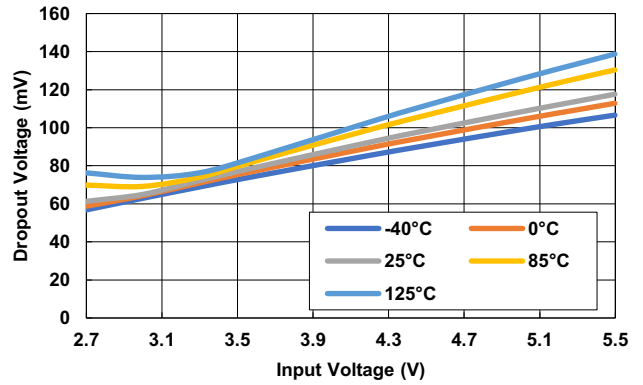

Figure 68. Dropout Voltage vs Input Voltage for Various Temperatures (I_{OUT} = 250mA)

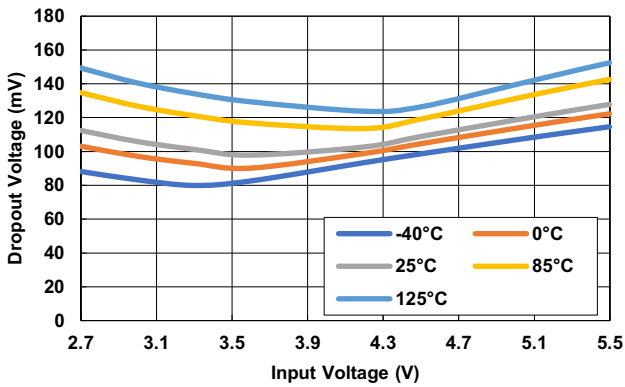

Figure 69. Dropout Voltage vs Input Voltage for Various Temperatures (I_{OUT} = 500mA)

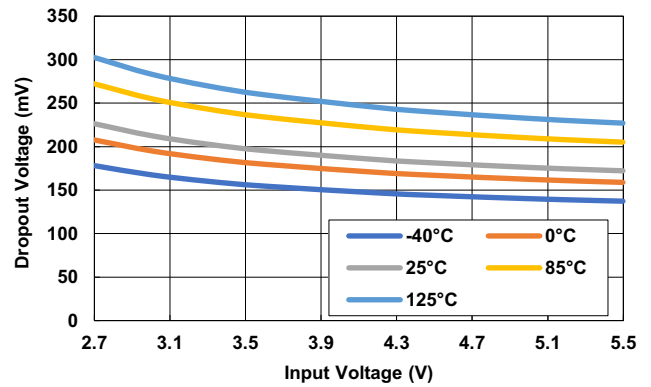

Figure 70. Dropout Voltage vs Input Voltage for Various Temperatures (I_{OUT} = 1A)

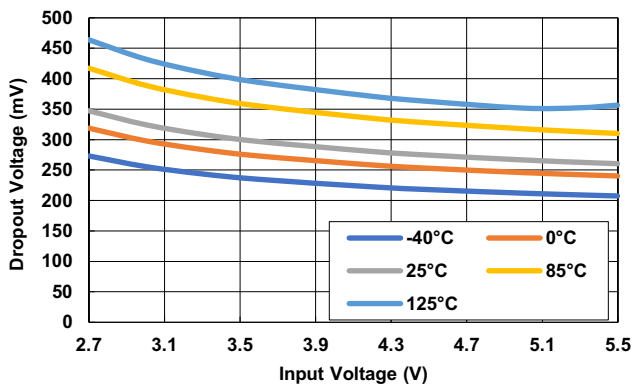

Figure 71. Dropout Voltage vs Input Voltage for Various Temperatures (I_{OUT} = 1.5A)

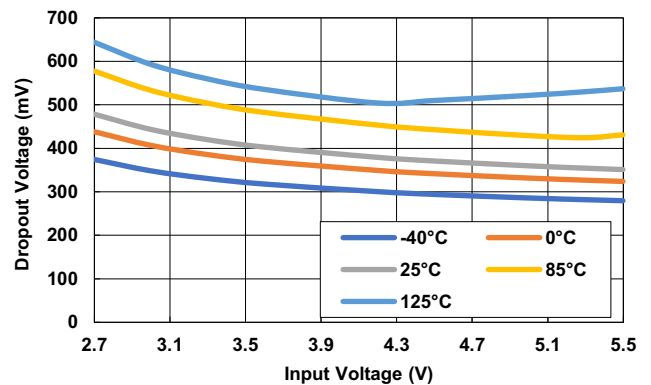

Figure 72. Dropout Voltage vs Input Voltage for Various Temperatures (I_{OUT} = 2A)

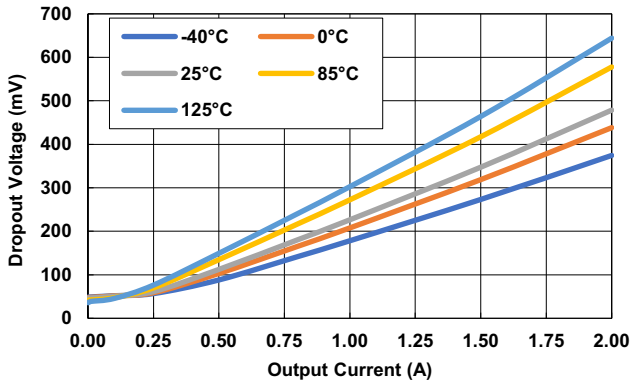

Figure 73. Dropout Voltage vs Output Current for Various Temperatures ($V_{IN} = 2.7V$)

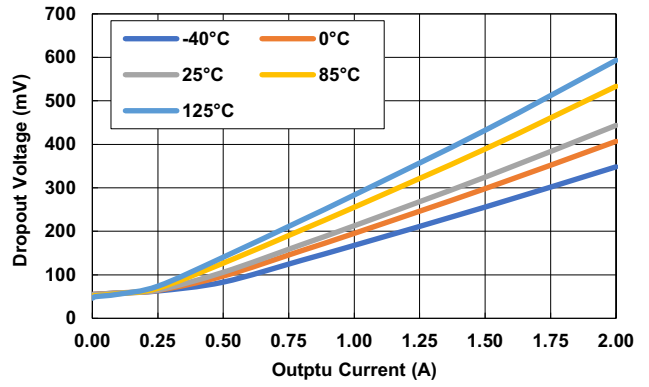

Figure 74. Dropout Voltage vs Output Current for Various Temperatures ($V_{IN} = 3V$)

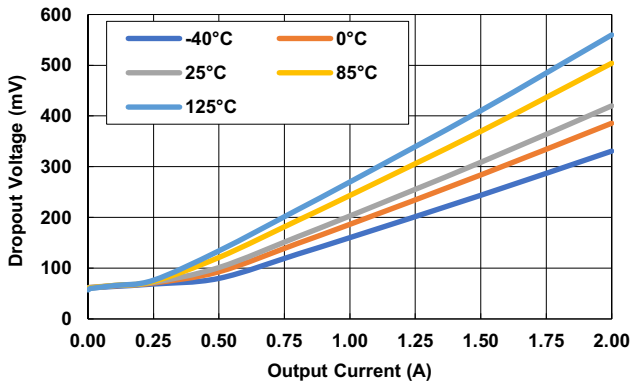

Figure 75. Dropout Voltage vs Output Current for Various Temperatures ($V_{IN} = 3.3V$)

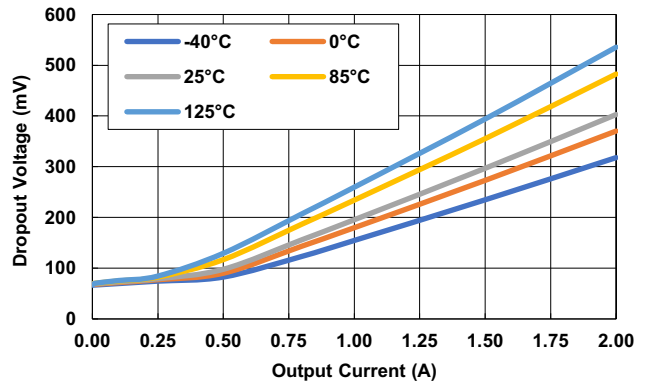

Figure 76. Dropout Voltage vs Output Current for Various Temperatures ($V_{IN} = 3.6V$)

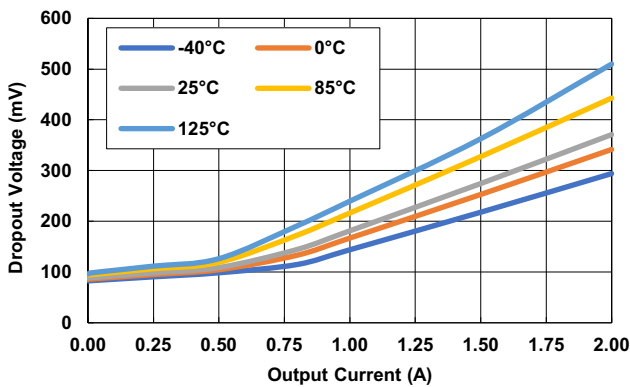

Figure 77. Dropout Voltage vs Output Current for Various Temperatures ($V_{IN} = 4.5V$)

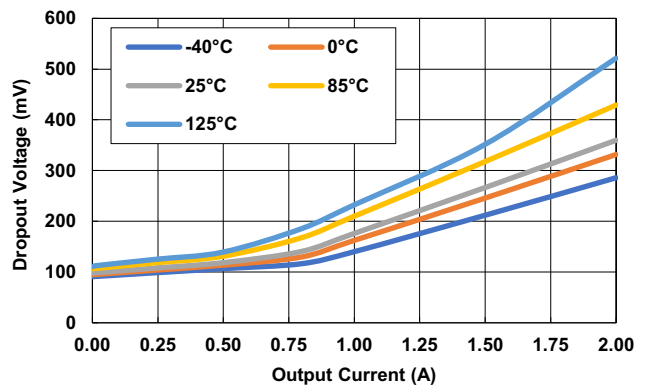

Figure 78. Dropout Voltage vs Output Current for Various Temperatures ($V_{IN} = 5V$)

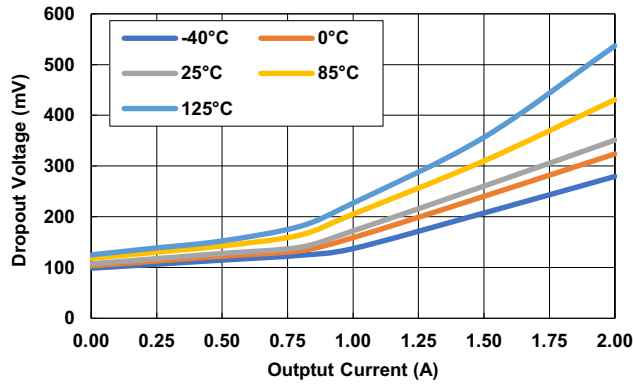

Figure 79. Dropout Voltage vs Output Current for Various Temperatures ($V_{IN} = 5.5V$)

4.5 General Performance

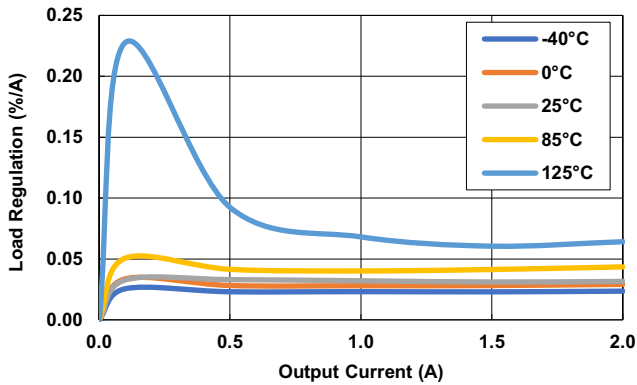

Figure 80. Load Regulation vs Output Current ($V_{IN} = 2.7V$, $V_{OUT} = 0.8V$, $\Delta I_{OUT} = 1mA$ to $2A$)

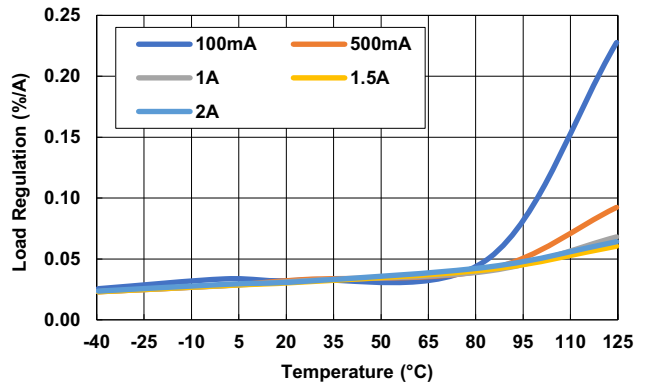

Figure 81. Load Regulation vs Temperature ($V_{IN} = 2.7V$, $V_{OUT} = 0.8V$, $\Delta I_{OUT} = 1mA$ to $2A$)

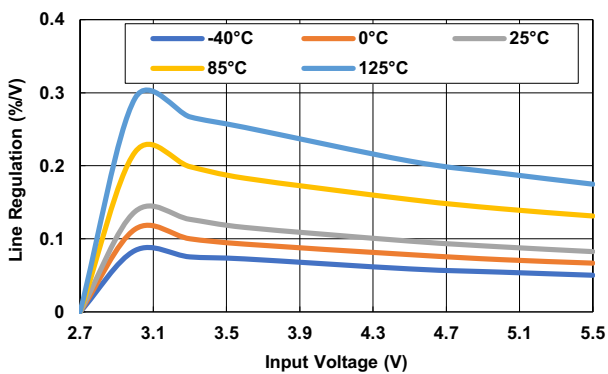

Figure 82. Line Regulation vs Input Voltage for Various Temps. ($V_{OUT} = 0.8V$, $I_{OUT} = 1mA$, $\Delta V_{IN} = 2.7V$ to $5.5V$)

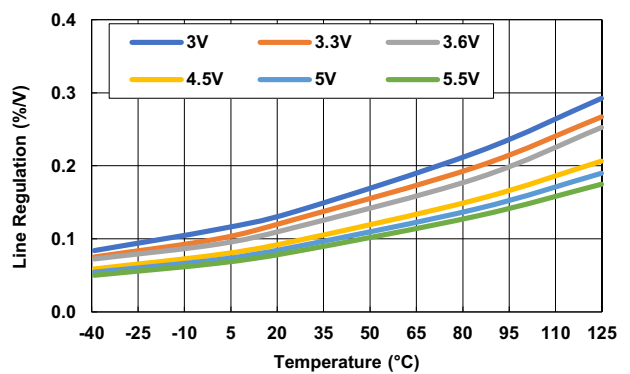

Figure 83. Line Regulation vs Temp. for Various Input Voltages ($V_{OUT} = 0.8V$, $I_{OUT} = 1mA$, $\Delta V_{IN} = 2.7V$ to $5.5V$)

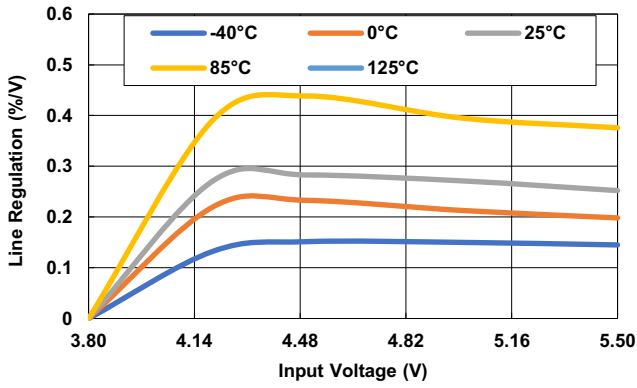

Figure 84. Line Regulation vs Input Voltage for Various Temps. ($V_{OUT} = 3.3V$, $I_{OUT} = 1mA$, $\Delta V_{IN} = 3.8V$ to $5.5V$)

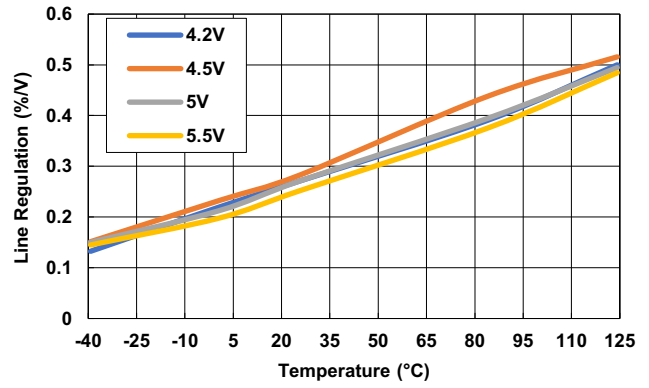

Figure 85. Line Regulation vs Temp. for Various Input Voltages ($V_{OUT} = 3.3V$, $I_{OUT} = 1mA$, $\Delta V_{IN} = 3.8V$ to $5.5V$)

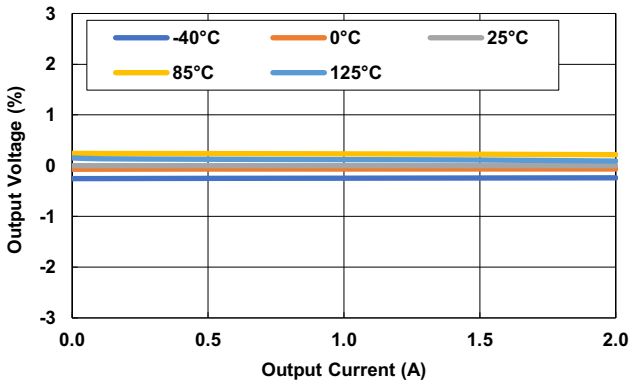

Figure 86. Output Voltage vs Load Current for various Temperatures ($V_{IN} = 2.7V$, $V_{OUT} = 0.8V$)

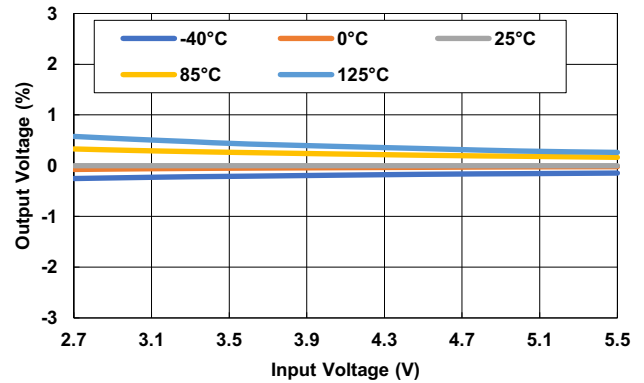

Figure 87. Output Voltage vs Input Voltage for various Temperatures ($V_{OUT} = 0.8V$, $I_{OUT} = 1mA$)

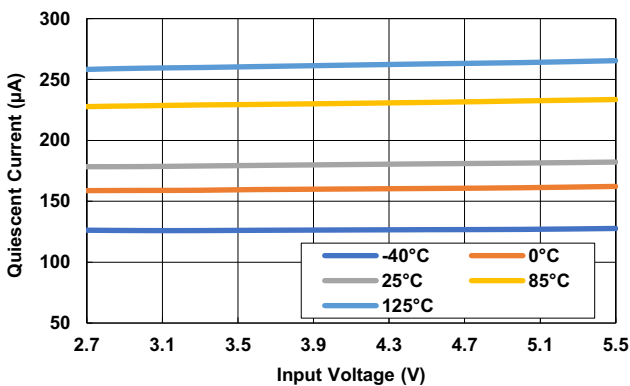

Figure 88. Quiescent Current vs Input Voltage for Various Temps. ($V_{OUT} = 0.8V$, $I_{OUT} = 0mA$)

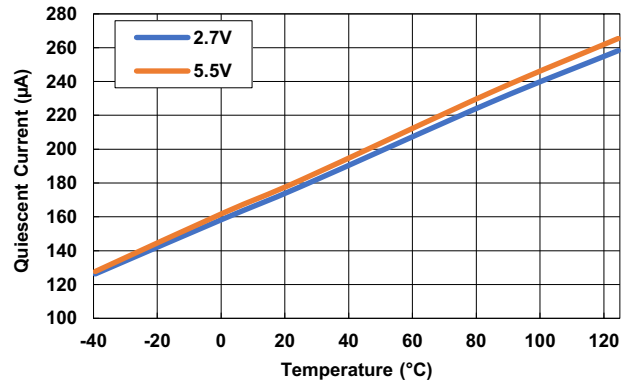

Figure 89. Quiescent Current vs Temp. for Various Input Voltages ($V_{OUT} = 0.8V$, $I_{OUT} = 0mA$)

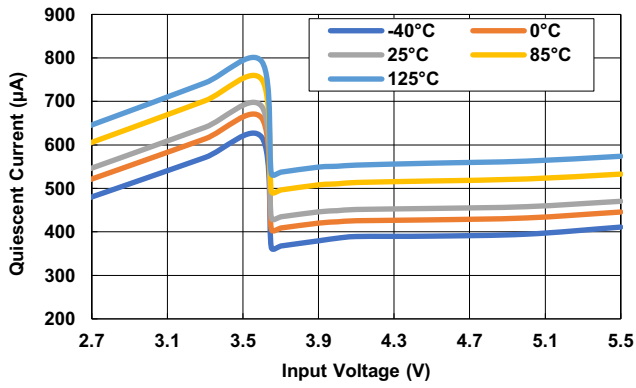

Figure 90. Quiescent Current vs Input Voltage for Various Temps. ($V_{OUT} = 3.95V$, $I_{OUT} = 0mA$)

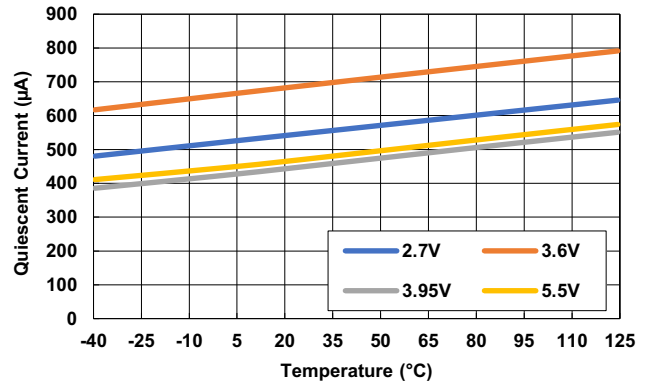

Figure 91. Quiescent Current vs Temp. for Various Input Voltages ($V_{OUT} = 3.95V$, $I_{OUT} = 0mA$)

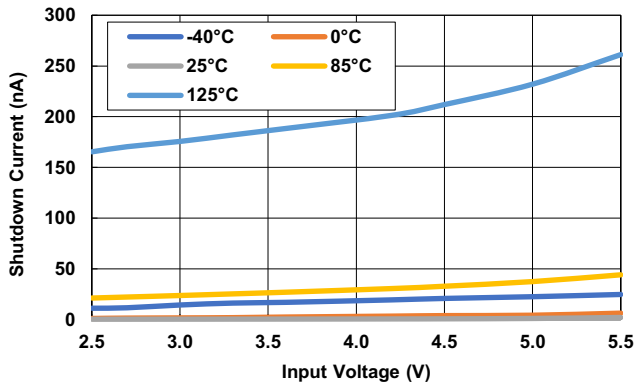

Figure 92. Shutdown Current vs Input Voltage for Various Temps. ($V_{EN} = 0V$)

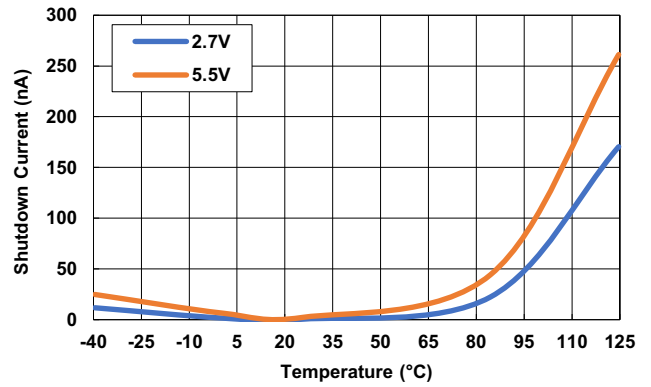

Figure 93. Shutdown Current vs Temp. for Various Input Voltages ($V_{EN} = 0V$)

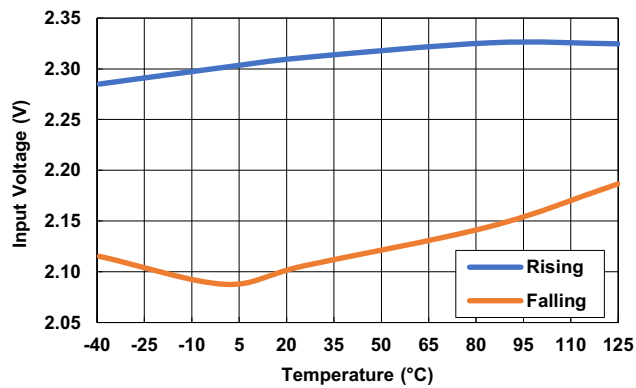

Figure 94. V_{IN} UVLO Thresholds vs Temperature

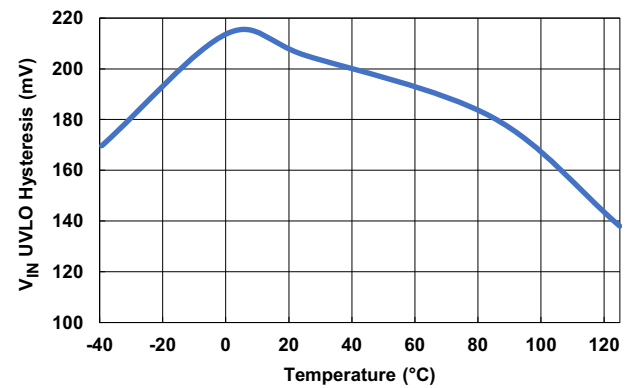

Figure 95. V_{IN} UVLO Hysteresis vs Temperature

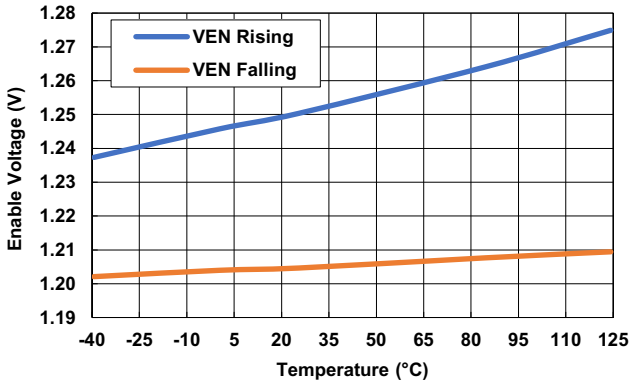

Figure 96. Enable Thresholds vs Temperature
($V_{IN} = 2.7V$)

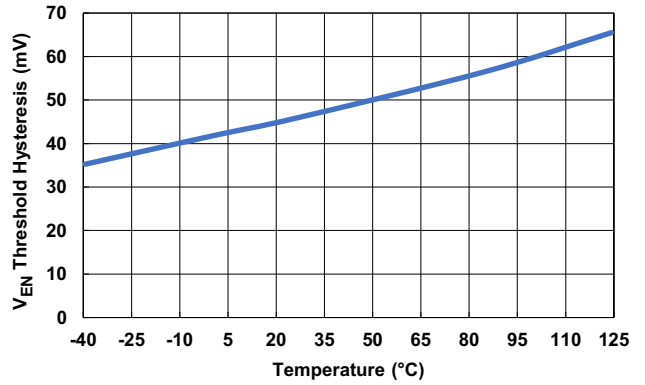

Figure 97. Enable Hysteresis vs Temperature
($V_{IN} = 2.7V$)

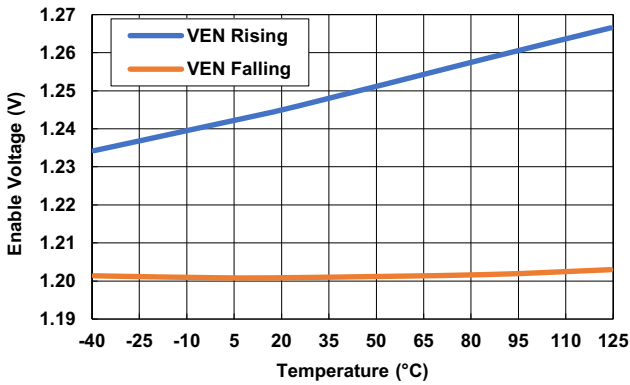

Figure 98. Enable Thresholds vs Temperature
($V_{IN} = 5.5V$)

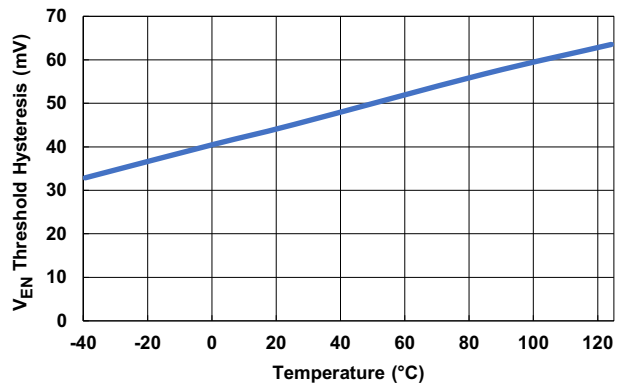

Figure 99. Enable Hysteresis vs Temperature
($V_{IN} = 5.5V$)

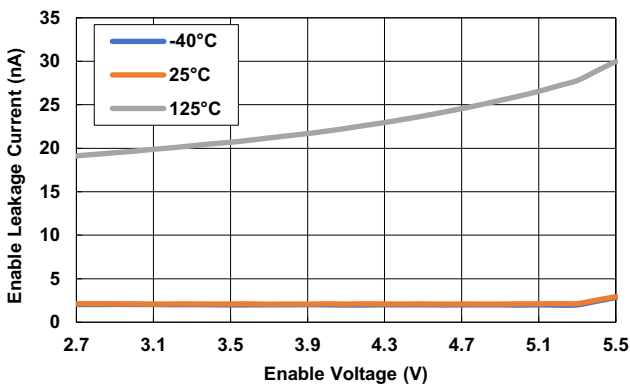

Figure 100. Enable Leakage Current vs Enable Voltage for Various Temperatures

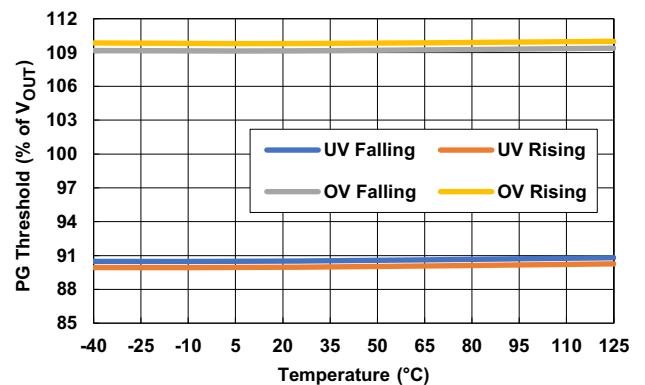

Figure 101. PG Thresholds vs Temperature ($V_{IN} = 2.7V$)

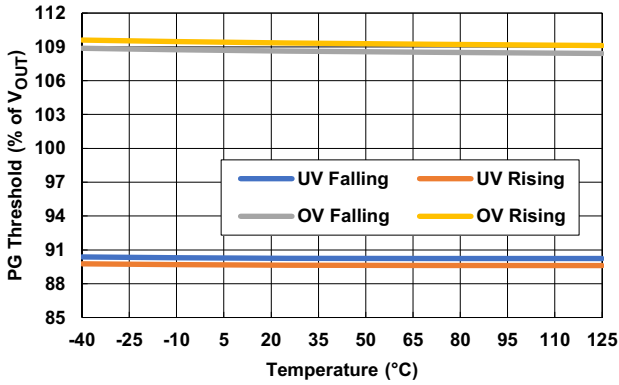

Figure 102. PG Thresholds vs Temperature ($V_{IN} = 5.5V$)

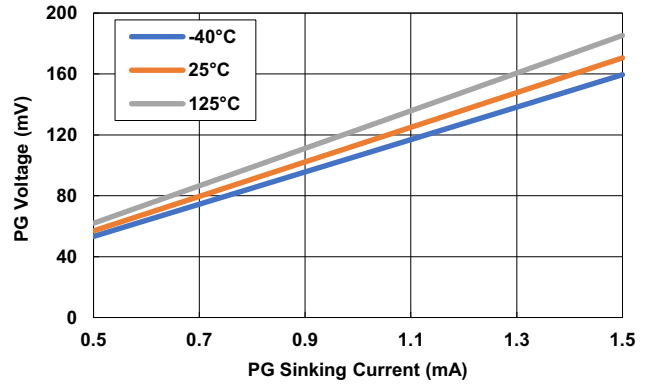

Figure 103. PG Voltage vs PG Sinking Current ($V_{IN} = 5.5V$)

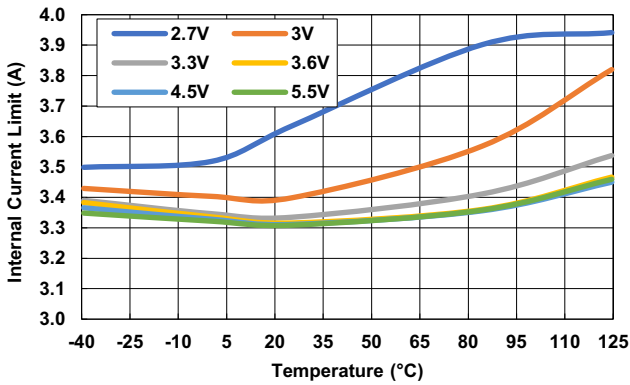

Figure 104. I_{LIM} vs Temperature for Various Input Voltages ($V_{OUT} = 1.8V$)

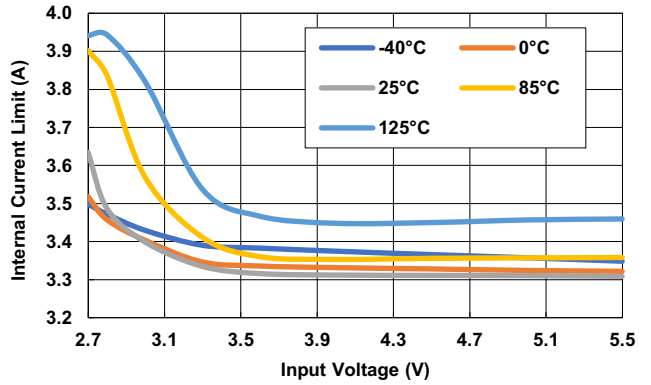

Figure 105. I_{LIM} vs Input Voltage for Various Temperatures ($V_{OUT} = 1.8V$)

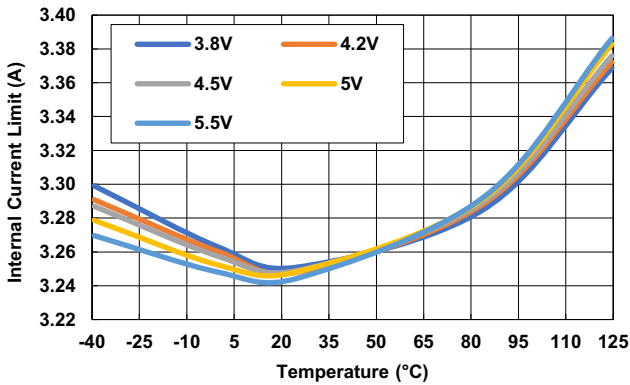

Figure 106. I_{LIM} vs Temperature for Various Input Voltages ($V_{OUT} = 3.3V$)

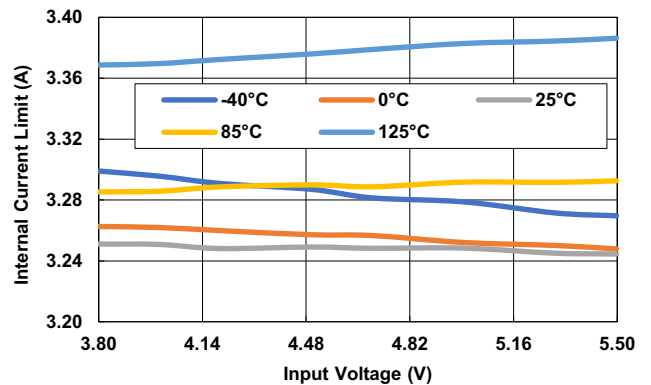

Figure 107. I_{LIM} vs Input Voltage for Various Temperatures ($V_{OUT} = 3.3V$)

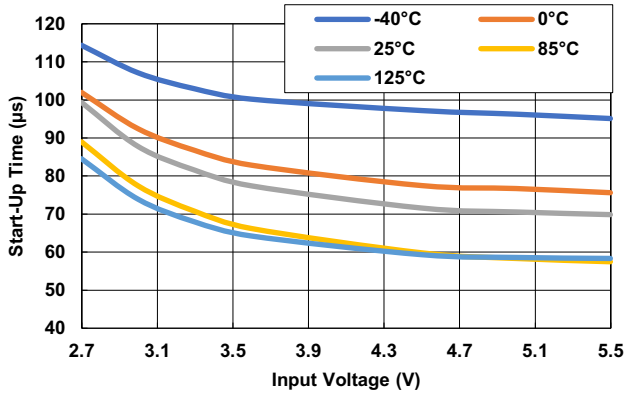

Figure 108. Start-Up Time vs Input Voltage
 ($V_{OUT} = 1.8V$, $C_{SET} = 100nF$, $C_{OUT} = 22\mu F$, $I_{OUT} = 2A$)

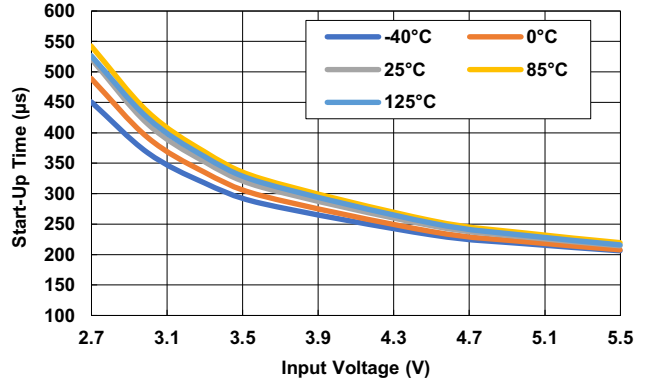

Figure 109. Start-Up Time vs Input Voltage
 ($V_{OUT} = 1.8V$, $C_{SET} = 1\mu F$, $C_{OUT} = 22\mu F$, $I_{OUT} = 2A$)

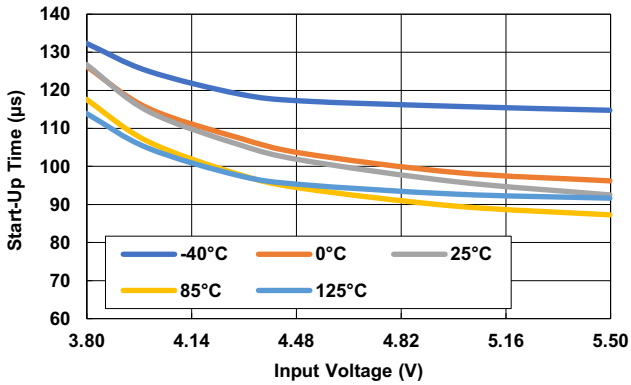

Figure 110. Start-Up Time vs Input Voltage
 ($V_{OUT} = 3.3V$, $C_{SET} = 100nF$, $C_{OUT} = 22\mu F$, $I_{OUT} = 2A$)

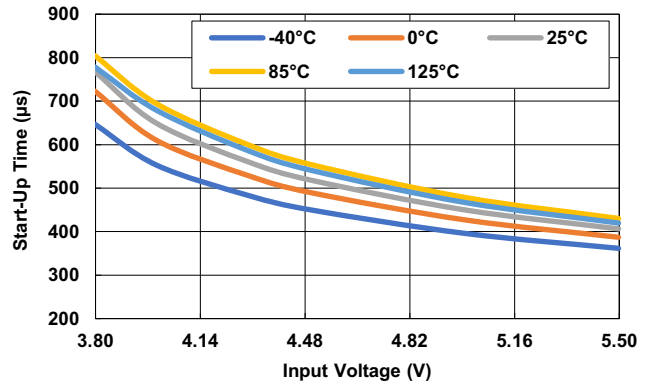

Figure 111. Start-Up Time vs Input Voltage
 ($V_{OUT} = 3.3V$, $C_{SET} = 1\mu F$, $C_{OUT} = 22\mu F$, $I_{OUT} = 2A$)

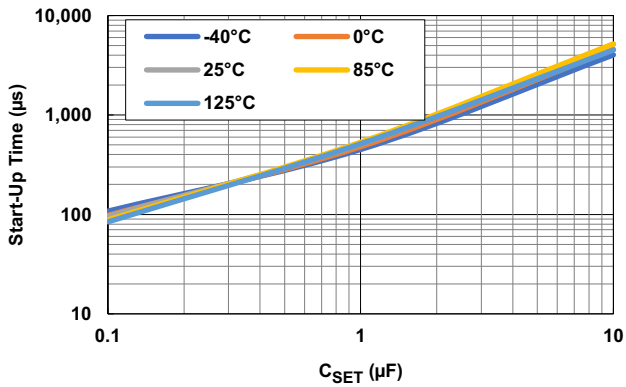

Figure 112. Start-Up Time vs C_{SET}
 ($V_{IN} = 2.7V$, $V_{OUT} = 1.8V$, $C_{OUT} = 22\mu F$, $I_{OUT} = 2A$)

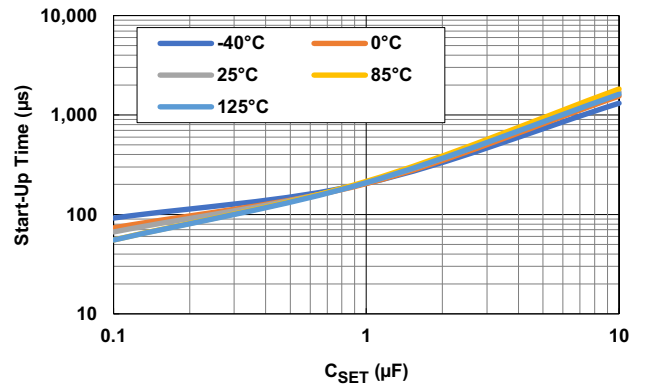

Figure 113. Start-Up Time vs C_{SET}
 ($V_{IN} = 5.5V$, $V_{OUT} = 1.8V$, $C_{OUT} = 22\mu F$, $I_{OUT} = 2A$)

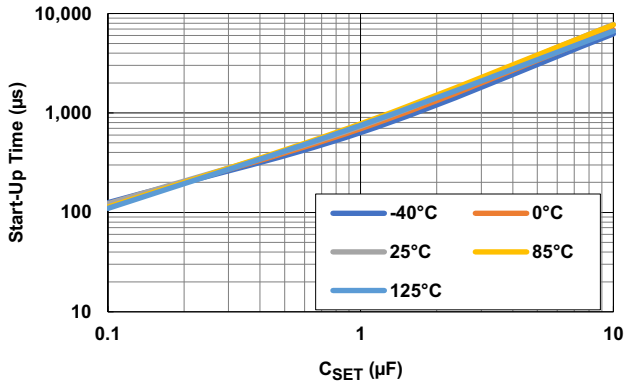

Figure 114. Start-Up Time vs C_{SET}
 ($V_{IN} = 3.8V$, $V_{OUT} = 3.3V$, $C_{OUT} = 22\mu F$, $I_{OUT} = 2A$)

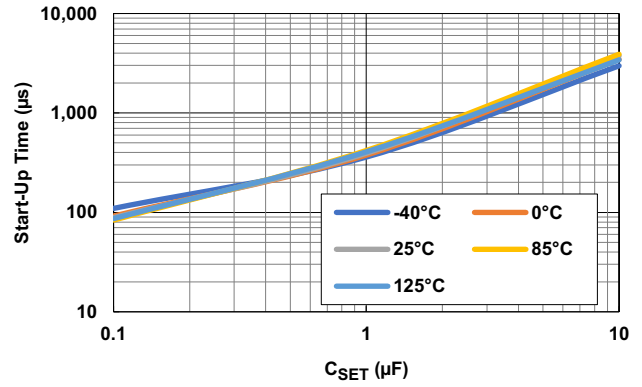

Figure 115. Start-Up Time vs C_{SET}
 ($V_{IN} = 5.5V$, $V_{OUT} = 3.3V$, $C_{OUT} = 22\mu F$, $I_{OUT} = 2A$)

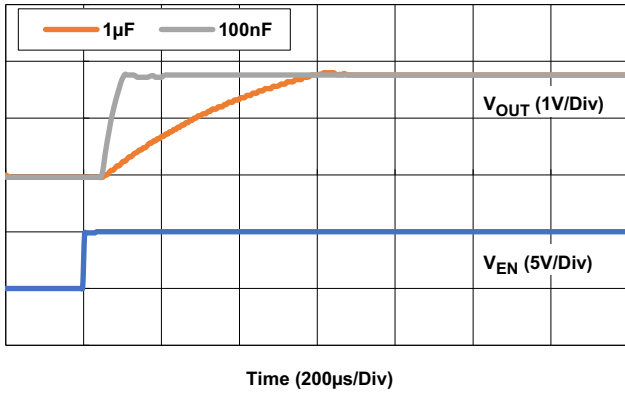

Figure 116. Start-Up Time for Various C_{SET} Capacitors
 ($V_{IN} = 2.7V$, $V_{OUT} = 1.8V$, $I_{OUT} = 2A$, $C_{OUT} = 22\mu F$)

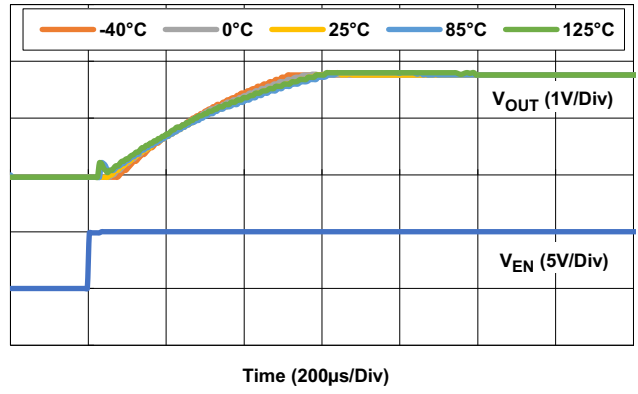

Figure 117. Start-Up Time for Various Temperatures
 ($V_{IN} = 2.7V$, $V_{OUT} = 1.8V$, $I_{OUT} = 2A$, $C_{SET} = 1\mu F$, $C_{OUT} = 22\mu F$)

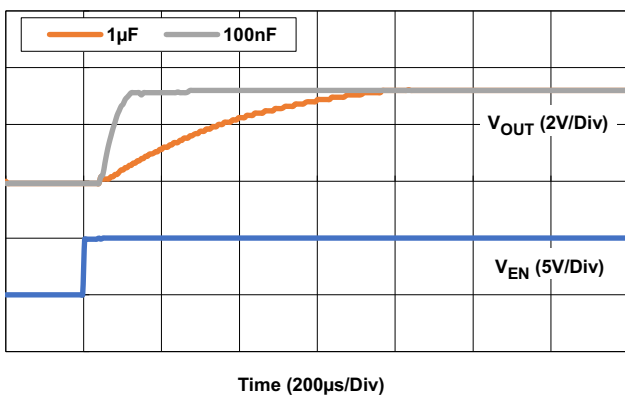

Figure 118. Start-Up Time for Various C_{SET} Capacitors
 ($V_{IN} = 5V$, $V_{OUT} = 3.3V$, $I_{OUT} = 2A$, $C_{OUT} = 22\mu F$)

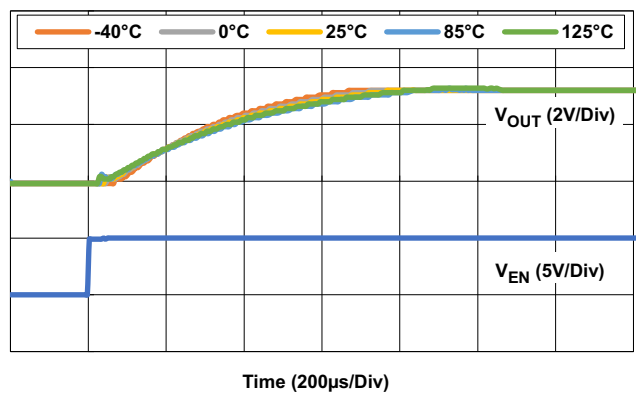

Figure 119. Start-Up Time for Various Temperatures
 ($V_{IN} = 5V$, $V_{OUT} = 3.3V$, $I_{OUT} = 2A$, $C_{SET} = 1\mu F$, $C_{OUT} = 22\mu F$)

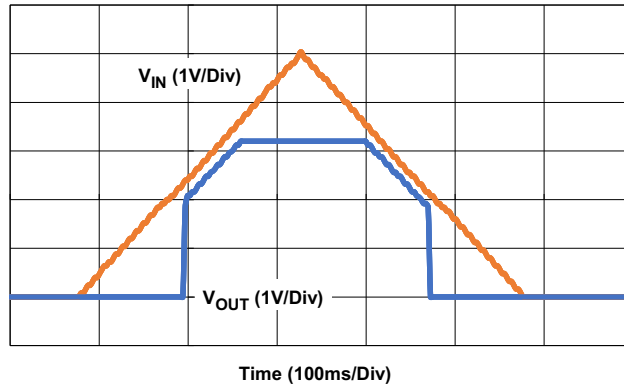

Figure 120. Input Supply Slow Ramp Up and Ramp Down
 ($\Delta V_{IN} = 0V$ to $5V$, $V_{OUT} = 3.3V$, $I_{OUT} = 2A$, $C_{SET} = 1\mu F$, $C_{OUT} = 22\mu F$)

5. Applications Information

5.1 Overview

The RAA214023 is an ultra-low noise, high PSRR, low-dropout (LDO) regulator featuring low noise applications. The LDO operates from an input voltage of 2.7V to 5.5V while sourcing a maximum 2A load with $\pm 1.75\%$ accuracy over line, load, and temperature. The output voltage can be adjusted by means of the voltage set pins from 0.8V to 3.95V or external feedback resistors from 0.8V to 5.5V-VDO. The LDO draws 195 μA current typical at no-load and has 200nA of shutdown current typical making it ideal for portable applications.

The RAA214023 is designed and tested with a 22 μF ceramic output capacitor, 10 μF input capacitor, and 1 μF noise reduction capacitor (C_{SET}). The LDO is available in either a 20 Ld 3.5mm \times 3.5mm or 5mm \times 5mm QFN package.

The RAA214023 integrates the following additional features in this package:

- Ultra-low output noise
- High Power Supply Ripple Rejection (PSRR)
- Convenient Voltage Set pins to set V_{OUT}
- Undervoltage lockout (UVLO)
- Enable control
- Internal current limit protection
- Thermal shutdown protection
- Power-good Indication
- Minimum 22 μF ceramic output capacitor for stability
- Output capacitor automatic discharge

5.2 Theory of Operation of PMOS LDOs

Like the majority of LDOs with a PMOS pass transistor, the RAA214023 DC output voltage (V_{OUT}) regulation can be modeled with a voltage reference (V_{REF}), PMOS pass-transistor, error amplifier and feedback (FB) resistors as shown in Figure 121.

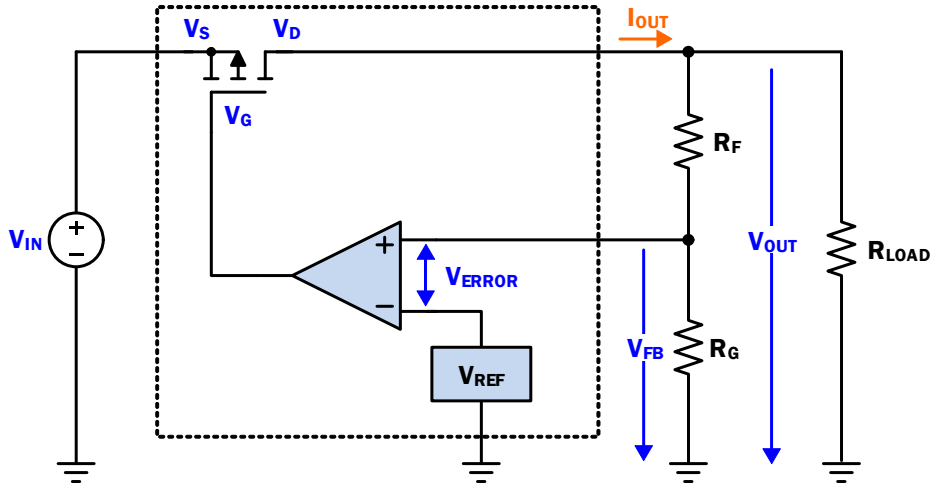

Figure 121. Simple PMOS LDO Regulator Block Diagram

The PMOS pass transistor can be modeled as a variable resistor ($r_{DS(ON)}$) that is controlled by the error amplifier to maintain a constant DC output voltage for changes in load current (I_{OUT}). Assuming the input voltage (V_{IN}) remains constant, the $r_{DS(ON)}$ is adjusted for a given I_{OUT} to set V_{OUT} . This relationship is summarized in Equation 1.

$$(EQ. 1) \quad V_{OUT} = V_{IN} - I_{OUT} \times R_{DS(ON)}$$

V_{OUT} is set using the FB resistor divider, which sets V_{OUT} to a value that corresponds to Equation 2.

$$(EQ. 2) \quad V_{OUT} = V_{FB} \times \left(\frac{R_F}{R_G} + 1 \right)$$

The error amplifier compares V_{FB} with the fixed V_{REF} voltage and works to minimize the difference or error voltage between V_{FB} and V_{REF} by changing the gate voltage of the PMOS pass transistor and therefore the $r_{DS(ON)}$.

If the I_{OUT} suddenly increases because of decreased load resistance, V_{OUT} decreases because the regulator has not responded to the change and the $r_{DS(ON)}$ is set too high. V_{FB} correspondingly decreases and is below the V_{REF} voltage therefore, increasing the error voltage. The error amplifier senses and minimizes the error by driving the PMOS gate voltage more negative relative to the FET source to decrease the $r_{DS(ON)}$, which increases the output voltage bringing it back into regulation.

By similar logic, a sudden decrease in I_{OUT} because of increased load resistance causes V_{OUT} to increase because the $r_{DS(ON)}$ is set too low. V_{FB} is then higher than the fixed V_{REF} voltage increasing the error. The error amplifier senses and minimizes the error by driving the PMOS gate voltage more positive relative to the FET source to increase the $r_{DS(ON)}$, which decreases the output voltage bringing it back into regulation.

For a more detailed explanation of the DC regulation operation of a PMOS LDO regulator, see *R16AN0008: Fundamental Theory of PMOS Low-Dropout Voltage Regulators*.

6. Functional Description

6.1 AC Performance

6.1.1 Ultra-Low Output Noise

The LDO output noise is the internally-generated noise created largely by the band-gap voltage reference (V_{REF}) and the error amplifier. It is commonly represented in units of nV/\sqrt{Hz} for a specific frequency or as an integrated root-mean square (RMS) value in μV over a range of frequencies typically 10Hz to 100kHz or 100Hz to 100kHz.

The RAA214023 output noise is largely independent of V_{OUT} and does not require a feed-forward capacitor to achieve very low output noise. For optimal low-noise, Renesas recommends using a $1\mu F$ CSET capacitor. See [CSET Capacitor](#) for selecting the correct CSET capacitor.

6.1.2 High Power Supply Ripple Rejection

The PSRR is how much attenuation or rejection the LDO control loop offers to externally generated VIN noise, such as from a switching regulator. Although PSRR represents a loss in the input noise signal, it is common to see it represented as a positive decibel (dB) number. Mathematically, PSRR is represented as a logarithmic ratio between an input and output ripple sinusoid signal at a specific frequency as shown in [Equation 3](#).

$$(EQ. 3) \quad PSRR(dB) = 20 \times \log\left(\frac{V_{IN(RIPPLE)}(f)}{V_{OUT(RIPPLE)}}\right)$$

The PSRR for the RAA214023 is largely independent of the output voltage. It is dependent on the headroom voltage, output current, and CSET capacitor. For optimal PSRR performance, a $1\mu F$ CSET capacitor is recommended. See [CSET Capacitor](#) for selecting the correct CSET capacitor.

[Table 2](#) lists the PSRR for different headroom voltages rails for 2A, 1A, 500mA, and 100mA loads at 120Hz, 1kHz, 10kHz, 100kHz, 500kHz, 1MHz, and 10MHz.

Table 1. Typical PSRR in dB for CSET = 1μF and COUT = 22μF

V _{HEADROOM}	I _{OUT}	120Hz	1kHz	10kHz	100kHz	500kHz	1MHz	10MHz
800mV	100mA	87	87	83	80	44	57	25
	500mA	86	85	80	63	41	53	18
	1A	84	85	70	50	39	50	15
	2A	79	70	50	31	27	43	15
1.7V	100mA	88	88	86	78	52	63	27
	500mA	86	88	85	85	51	60	19
	1A	86	88	83	73	48	56	17
	2A	85	100	80	62	45	51	15

6.1.3 Load Transient Response

The load-step transient response is the output voltage response of the LDO because of a step change in load current. The magnitude of the undershoot is directly proportional to the amount of output capacitance and the slew rate of the load current step.

If the undershoot takes V_{OUT} below -10% of its programmed value, the PG circuitry responds by connecting CSET to the fast start-up circuitry to rapidly bring V_{OUT} back to within $\pm 10\%$ of its programmed value.

During sudden decreases in I_{OUT} , the V_{OUT} increases and overshoots. The LDO responds to the overshoot by turning off the main pass-transistor and waits for C_{OUT} to discharge. If the V_{OUT} overshoot takes V_{OUT} above +10

of its programmed value, the PG circuitry responds by connecting a 1kΩ pull-down resistor to quickly discharge the C_{OUT} and brings V_{OUT} back to within ±10% of its programmed value. The 1kΩ remains connected if V_{OUT} is above +10% of its programmed value.

A larger output capacitance value can marginally decrease the overshoot and undershoot magnitude. However, doing so can increase the response time of the LDO to undershoots and overshoots, in addition to increasing the output noise. See [Output Capacitor](#) for selecting the correct output capacitor.

6.2 UVLO

The RAA214023 integrates an internal UVLO circuit to keep the output voltage safely disabled if the input voltage is below the UVLO threshold (2.5V typical). When the input voltage is above the UVLO threshold, the part is enabled and the output voltage ramps up. The UVLO hysteresis prevents input voltage noise from causing the output to oscillate.

When V_{IN} is below the UVLO, an internal 300Ω discharge resistor connects the LDO output to ground to quickly discharge the output capacitor. The resistor is connected to the output capacitor when the input voltage is greater than 1V but less than the UVLO Threshold of 2.5V typical. [Figure 122](#) illustrates the UVLO operation.

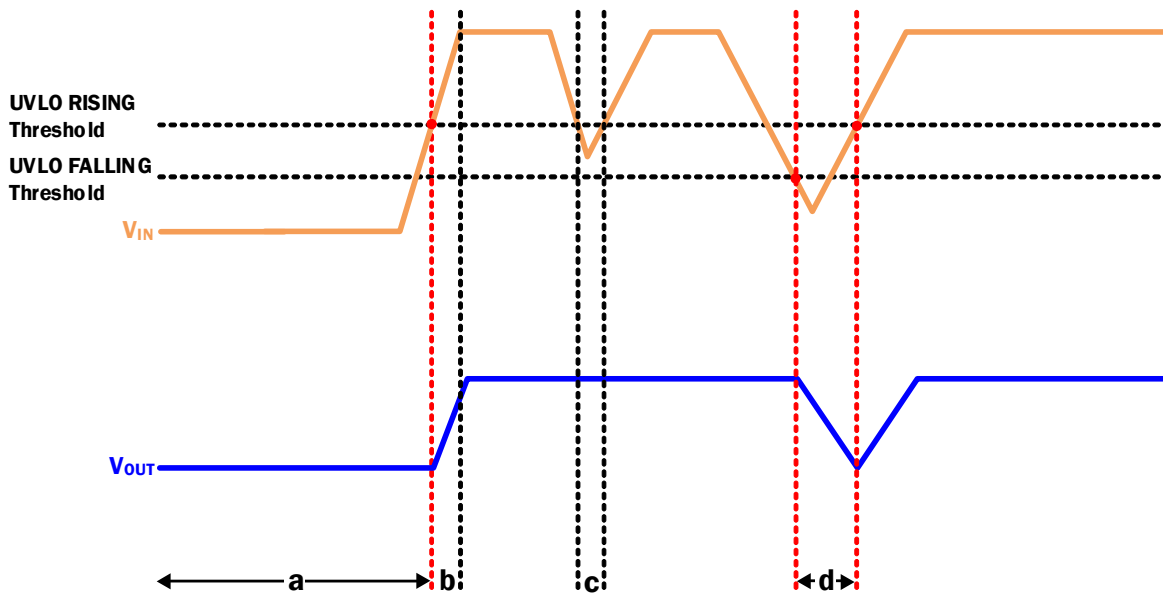

Figure 122. UVLO Operation

Starting with V_{IN} = 0V and V_{OUT} = 0V:

- a, d The LDO is disabled and the internal 300Ω discharge resistor is connected to the output voltage as long as the input voltage is between 1V to 2.5V.
- b The LDO is enabled and starts to rise. The 300Ω discharge resistor is disconnected from output voltage.
- c The LDO remains enabled and the 300Ω discharge resistor remains disconnected.

6.3 Enable Control

The RAA214023 uses the EN pin voltage (V_{EN}) to enable or disable the LDO. If V_{EN} is less than the V_{EN} threshold, the LDO is disabled. If V_{EN} is greater than the V_{EN} threshold, the LDO is enabled. The V_{EN} hysteresis prevents enable voltage noise from causing the output to oscillate. When the LDO is disabled, the shutdown current is typically a couple of nanoamps.

When V_{EN} is below the V_{EN} threshold and the input voltage is greater than or equal to 1V, the same 300Ω discharge resistor controlled by the UVLO circuitry is connected between the LDO output and GND to quickly discharge the output capacitor.

The EN pin can be directly connected to the input voltage for automatic start-up or connected to a logic controller such as an MCU or FPGA. Some logic pins use an open-collector or open-drain transistor to pull LOW and float when HIGH. Make sure to connect a 1kΩ or 10kΩ pull-up resistor to ensure proper logic HIGH. To ensure proper Enable control operation, the VEN signal source should be capable of swinging above and below the threshold values.

6.4 Integrated Protection Features

6.4.1 Internal Current Limit (ILIM)

The Internal current limit (ILIM) circuitry limits the maximum output current the LDO can source during fault conditions such as short-circuits or start-up inrush current. ILIM is set above the maximum recommended output current of the RAA214023 (2A).

During a short-circuit fault, the LDO becomes a constant current source and as a result any decrease in load resistance causes a decrease in the output voltage. This relationship is summarized in Equation 2.

$$(EQ. 4) \quad V_{OUT} = ILIM \times R_{FAULT}$$

When the short or over-current condition is removed, the LDO returns to regulation. Because of the high power dissipation caused by over-current faults, the LDO may begin to cycle ON and OFF because the die junction temperature (T_J) is exceeding thermal fault conditions ($+155^\circ\text{C}$) and subsequently cooling down to $+145^\circ\text{C}$ when the LDO is disabled.

6.4.2 Thermal Protection

The RAA214023 is protected against thermal overloads caused by current limit protection or high ambient temperature (T_A).

When the die junction temperature (T_J) exceeds $+155^\circ\text{C}$, the thermal shutdown circuit disables the LDO reducing the output current (I_{OUT}) to 0A and therefore reducing the output voltage (V_{OUT}) to 0V allowing the LDO to cool. A 10°C hysteresis is included to prevent the LDO from uncontrollably heating and cooling.

Prolonged exposure to a T_J exceeding $+125^\circ\text{C}$ reduces the long-term stability and life of the LDO. Therefore, it is important that the design considers the T_A the LDO works in, the thermal resistance between T_J and T_A (θ_{JA}), and any fault conditions that can cause the T_J to exceed the recommended operating range. In some applications, a heat sink may need to be implemented. See [Power Dissipation and Thermals](#) to determine the maximum junction temperature for an application.

6.5 Power-Good (PG) Indication

The Power-Good (PG) pin is an open-drain NMOS-FET. The PG pin circuitry works by monitoring the FB voltage to indicate whether the output voltage is within $\pm 10\%$ of 0.8V. When the output voltage is $\pm 10\%$ outside of its programmed value, the PG circuitry drives the NMOS FET ON and indicates LOW on the PG pin. When the output voltage is within $\pm 10\%$ of its programmed value, the PG circuitry drives the NMOS-FET OFF and the PG pin becomes HIGH.

When the output voltage is below the PG Undervoltage (UV) thresholds, the fast-start up circuitry is activated to bring V_{OUT} within the $\pm 10\%$ window. When the output voltage is above the PG Overvoltage (OV) thresholds, a

1kΩ pull-down resistor connects V_{OUT} to GND to discharge the output capacitor and bring the output voltage back within the $\pm 10\%$ window. Figure 123 illustrates the PG operation.

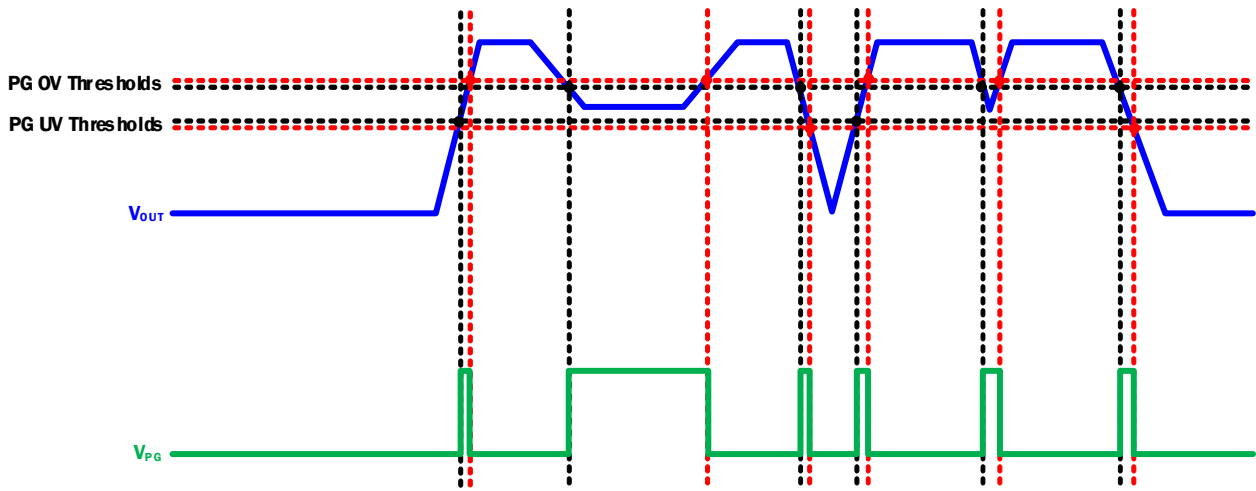

Figure 123. PG Operation

A 10kΩ or 100kΩ pull-up resistor is recommended to tie PG pin to V_{IN} , V_{OUT} , or an external supply to ensure a proper HIGH voltage to any downstream logic device such as an MCU or FPGA. If the PG pin is not being used, it can be left floating.

6.6 DC Performance

6.6.1 Dropout Voltage

The dropout voltage (VDO) is defined as the voltage drop across the primary, current-carrying pass-transistor in the ohmic region of operation at a rated load current, input voltage, and junction temperature. The LDO performance is negatively affected in the dropout region. For proper DC regulation, the LDO input voltage must be some margin higher than the output voltage.

6.6.2 Output Current

The RAA214023 remains stable and in regulation with no external load.

6.7 Output Capacitor Automatic Discharge

The RAA214023 features a 300Ω and 1kΩ discharge resistor to rapidly discharge the output capacitor. The 300Ω discharge resistor is controlled by the ENABLE circuitry and UVLO circuitry, and the 1kΩ discharge resistor is controlled by the PG circuitry.

The 300Ω discharge resistor is connected to the LDO output when either the enable voltage is below the V_{EN} threshold, or the input voltage is below the UVLO threshold but greater than or equal to 1V. If the input voltage collapses faster than the discharge circuitry can discharge the output capacitor, the output voltage may be greater than the input voltage. In this case, C_{OUT} discharges through the PMOS transistor body diode.

The 1kΩ discharge resistor is connected to the LDO output when V_{OUT} overshoots above 10% final value. Without it, the regulator would have to wait a long time for C_{OUT} to discharge during very rapid, large load steps.

6.8 Voltage Requirements

6.8.1 Input Voltage

The RAA214023 operates with an input voltage of 2.7V to 5.5V on the VIN pin. The input supply must be able to supply enough current to keep the input voltage from drooping during load steps or high load currents.

For proper voltage regulation the input voltage must be chosen so that it is higher than the sum of the output voltage and the maximum dropout voltage expected for a given application as expressed in [Equation 5](#).

$$(EQ. 5) \quad V_{IN} > V_{OUT} + V_{DROPOUT(MAX)}$$

The difference between VIN and VOUT required for proper regulation is commonly called the headroom voltage (VHEADROOM).

6.9 Adjusting the Output Voltage

The output voltage can be programmed by means of the voltage setting pins or with traditional external feedback resistors. Whichever configuration a designer decides to use, the internal operation of the RAA214023 will be the same.

6.9.1 Voltage Set Pins

To properly use the Voltage Set pins the SNS pin must be shorted to the OUT pin(s) as shown in [Figure 124](#). In this configuration the output voltage can be programmed from 0.8V to 3.95V in steps of 50mV.

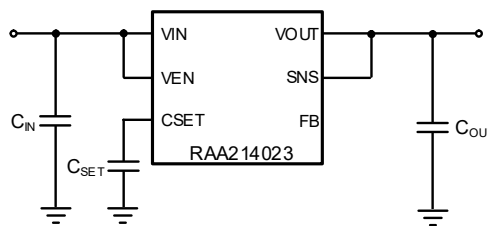

Figure 124. Programming Output Voltage with Voltage Set Pins

The Voltage Set pins are labeled 50mV (Pin 5), 100mV (pin 6), 200mV (Pin 7), 400mV (Pin 9), 800mV (Pin 10) and 1.6V (Pin 11). These pins are either grounded or left floating using the PCB layout. Grounding these pins adds the voltages assigned to each grounded pin to the reference voltage (0.8V) as shown in [Equation 6](#). For example, to set $V_{OUT(TARGET)}$ to 3.3V ground the 100mV, 800mV, and 1.6V pins. The sum of these three pins (2.5V) added to the 0.8V reference gives the expected 3.3V V_{OUT} .

$$(EQ. 6) \quad V_{OUT} = 0.8V + \Sigma(\text{Grounded Voltage Set Pins})$$

[Table 2](#) is a full list of all the possible $V_{OUT(TARGET)}$ and the corresponding Voltage Set pins to short to ground.

Table 2. User Configurable Output Voltage Settings

V_{OUT} (V)	50mV	100mV	200mV	400mV	800mV	1.6V	V_{OUT} (V)	50mV	100mV	200mV	400mV	800mV	1.6V
0.80	Open	Open	Open	Open	Open	Open	2.40	Open	Open	Open	Open	Open	GND
0.85	GND	Open	Open	Open	Open	Open	2.45	GND	Open	Open	Open	Open	GND
0.90	Open	GND	Open	Open	Open	Open	2.50	Open	GND	Open	Open	Open	GND
0.95	GND	GND	Open	Open	Open	Open	2.55	GND	GND	Open	Open	Open	GND
1.00	Open	Open	GND	Open	Open	Open	2.60	Open	Open	GND	Open	Open	GND

Table 2. User Configurable Output Voltage Settings (Cont.)

V _{OUT} (V)	50mV	100mV	200mV	400mV	800mV	1.6V	V _{OUT} (V)	50mV	100mV	200mV	400mV	800mV	1.6V
1.05	GND	Open	GND	Open	Open	Open	2.65	GND	Open	GND	Open	Open	GND
1.10	Open	GND	GND	Open	Open	Open	2.70	Open	GND	GND	Open	Open	GND
1.15	GND	GND	GND	Open	Open	Open	2.75	GND	GND	GND	Open	Open	GND
1.20	Open	Open	Open	GND	Open	Open	2.80	Open	Open	Open	GND	Open	GND
1.25	GND	Open	Open	GND	Open	Open	2.85	GND	Open	Open	GND	Open	GND
1.30	Open	GND	Open	GND	Open	Open	2.90	Open	GND	Open	GND	Open	GND
1.35	GND	GND	Open	GND	Open	Open	2.95	GND	GND	Open	GND	Open	GND
1.40	Open	Open	GND	GND	Open	Open	3.00	Open	Open	GND	GND	Open	GND
1.45	GND	Open	GND	GND	Open	Open	3.05	GND	Open	GND	GND	Open	GND
1.50	Open	GND	GND	GND	Open	Open	3.10	Open	GND	GND	GND	Open	GND
1.55	GND	GND	GND	GND	Open	Open	3.15	GND	GND	GND	GND	Open	GND
1.60	Open	Open	Open	Open	GND	Open	3.20	Open	Open	Open	Open	GND	GND
1.65	GND	Open	Open	Open	GND	Open	3.25	GND	Open	Open	Open	GND	GND
1.70	Open	GND	Open	Open	GND	Open	3.30	Open	GND	Open	Open	GND	GND
1.75	GND	GND	Open	Open	GND	Open	3.35	GND	GND	Open	Open	GND	GND
1.80	Open	Open	GND	Open	GND	Open	3.40	Open	Open	GND	Open	GND	GND
1.85	GND	Open	GND	Open	GND	Open	3.45	GND	Open	GND	Open	GND	GND
1.90	Open	GND	GND	Open	GND	Open	3.50	Open	GND	GND	Open	GND	GND
1.95	GND	GND	GND	Open	GND	Open	3.55	GND	GND	GND	Open	GND	GND
2.00	Open	Open	Open	GND	GND	Open	3.60	Open	Open	Open	GND	GND	GND
2.05	GND	Open	Open	GND	GND	Open	3.65	GND	Open	Open	GND	GND	GND
2.10	Open	GND	Open	GND	GND	Open	3.70	Open	GND	Open	GND	GND	GND
2.15	GND	GND	Open	GND	GND	Open	3.75	GND	GND	Open	GND	GND	GND
2.20	Open	Open	GND	GND	GND	Open	3.80	Open	Open	GND	GND	GND	GND
2.25	GND	Open	GND	GND	GND	Open	3.85	GND	Open	GND	GND	GND	GND
2.30	Open	GND	GND	GND	GND	Open	3.90	Open	GND	GND	GND	GND	GND
2.35	GND	GND	GND	GND	GND	Open	3.95	GND	GND	GND	GND	GND	GND

6.9.2 External Feedback Resistors

The RAA214023 output voltage (V_{OUT}) can be programmed down to 0.8V and up to $5.5V - V_{DO}$ using the feedback (FB) resistors, R_F and R_G , as shown in [Figure 125](#).

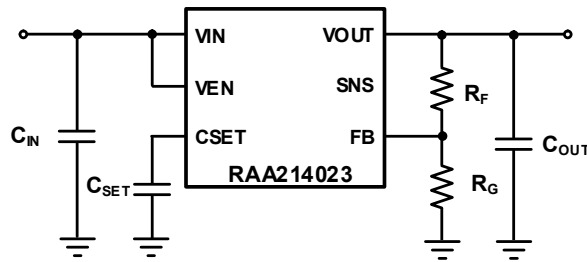

Figure 125. RAA214023 Simplified Application Schematic

V_{OUT} is calculated using [Equation 7](#).

$$(EQ. 7) \quad V_{OUT} = 0.8V \times \left(1 + \frac{R_F}{R_G} \right)$$

Similarly, the R_F and R_G resistors are calculated for any target output voltage by rearranging [Equation 7](#) to get [Equation 8](#) and solving for R_F .

$$(EQ. 8) \quad R_F = R_G \times \left(\frac{V_{OUT(TARGET)}}{0.8V} - 1 \right)$$

[Table 3](#) suggests the FB resistor values to get some common voltage rails with 0.1% error. These resistors are commercially available in 0.1% tolerances. This table is not exhaustive and there may be other R_F and R_G resistor combinations that can provide better accuracy.

Table 3. Recommended R_F and R_G Feedback Resistor Values for Common Voltage Rails

$V_{OUT(TARGET)}$ (V)	R_F (k Ω)	R_G (k Ω)	V_{OUT} Accuracy (%)
1	2.55	10.2	0.0
1.2	5.9	11.8	0.0
1.5	10.5	12	0.0
1.8	15	12	0.0
1.9	15.8	11.5	-0.05
2.5	25.5	12	0.0
3	31.6	11.5	-0.06
3.3	75	24	0.0
4.2	51	12	0.0
4.5	74.1	16	0.1
5	105	20	0.0

6.10 External Bypass Capacitor Selection

The RAA214023 is stable with C_{IN} , C_{OUT} , and C_{SET} bypass capacitors. Multilayer ceramic capacitors (MLCC) are an excellent choice for bypass capacitors because of their small size, low ESR, low ESL, and wide operating temperature. They are not without their problems though. Ceramic capacitor values can vary with the DC bias voltage, temperature, and tolerance. Therefore, Renesas recommends that they be de-rated.

X5R, X7R, and C0G capacitors are recommended. Low cost Y5V and Z5U capacitors are acceptable if they are properly de-rated. To ensure the performance of the RAA214023, it is important that the effects of DC bias voltage, temperature, and tolerances for a chosen capacitor are evaluated.

Place the bypass capacitors as close as is practical to their respective pins to minimize trace inductance.

6.10.1 Input Capacitor

The minimum input capacitor required on the VIN pin for proper operation and stability is 10 μ F. A 10 μ F input capacitor also helps reduce the negative effects of large input impedances because of long input traces or high source-impedances. Additional bypass capacitors with different self-resonant frequencies can be paralleled with 10 μ F to keep the input impedance low across a wider frequency range, if required.

When output capacitor values larger than 22 μ F are used, increase the input capacitor to match it. Input capacitors greater than 10 μ F can also help minimize input voltage droops during large changes in load current and during start-up and do not affect stability. **IMPORTANT:** Ensure that the combination of trace and wire inductance, and the input capacitor chosen do not cause unwanted ringing because of the resonance formed by the LC tank circuit. Keep input traces and wires short to minimize resonance.

6.10.2 Output Capacitor

The RAA214023 is stable with a 22 μ F minimum ceramic output capacitor on the VOUT pin.

A larger value output capacitor generally improves the transient response because of large changes in load current but can also increase the load transient response time because of the decreased loop bandwidth. A disadvantage to increasing the output capacitor value is increased output noise and longer load transient response times.

The high frequency PSRR can be improved to target specific frequencies such as from a switching regulator if the output capacitor PSRR peak is chosen to equal the switching frequency of the upstream supply noise.

Additional output capacitors can be paralleled with the 22 μ F to improve PSRR and output noise performance across a wider frequency range.

6.10.3 C_{SET} Capacitor

The RAA214023 requires a minimum 100nF C_{SET} bypass capacitor on the CSET pin for stability. Increasing the C_{SET} value reduces the output noise and increases PSRR and the start-up time.

Some ceramic capacitors experience a piezoelectric response that causes the capacitor to generate noise when exposed to mechanical stress or thermal transients. Most high dielectric type (X5R and X7R) have a piezoelectric response. This appears as increased low-frequency noise on the output. To remedy this, Renesas recommends using low dielectric type ceramic capacitors such as NP0 or C0G capacitors that have negligible piezoelectric effects.

Note: Large leakage currents on the CSET pin can cause DC offsets and adds additional noise to the output voltage. Therefore leakage currents around this pin should be minimized.

6.10.3.1 Noise Optimization

For low-noise applications, a 1 μ F C_{SET} capacitor is optimal. Larger capacitor values can be used with little benefit in lowering the internally generated output voltage noise for frequencies above 10Hz.

6.10.3.2 Fast Start-Up

The RAA214023 incorporates fast start-up circuitry by default to rapidly charge the C_{SET} capacitor. This decreases the output voltage ramp-time because the C_{SET} node voltage sets the output voltage as well. The RAA214023 switches to the normal regulation circuitry when V_{OUT} reaches 90% of its programmed value.

When switching between the fast start-up circuitry and the normal regulation circuitry, the C_{SET} capacitor experiences a sudden open-circuit, which exercises the dielectric absorption of the capacitor. Depending on the amount of dielectric absorption of the C_{SET} capacitor, the switch between the fast start-up circuitry and the normal regulation circuitry can cause the output voltage to droop by 10s of millivolts during startup. Depending on the value of the output capacitor, the droop can take a second or longer to recover. The Dielectric absorption can depend on package size, voltage rating, dielectric material, and even manufacturer technology. Therefore, the C_{SET} capacitor needs to be evaluated if minimizing the output voltage droop is important.

6.10.3.3 Start-Up Time

The start-up time of the RAA214023 can be adjusted with the value of the C_{SET} capacitor along with input and output voltage using Equation 9.

$$(EQ. 9) \quad T_{SS} = -\ln\left(1 - 0.9 \times \frac{V_{OUT}}{V_{IN}}\right) \times 380000 \times C_{SET}$$

The start-up time of the RAA214023 is defined as the time it takes for the output voltage to rise from 10% to 90% of its final value as soon as the V_{EN} crosses its threshold.

- Increasing the headroom voltage or decreasing the C_{SET} capacitor decreases the start-up time.
- Decreasing the headroom voltage or increasing the C_{SET} capacitor increases the start-up time.

An example for an application of 3.3V input voltage to 1V and 2.5V output is shown in Figure 126.

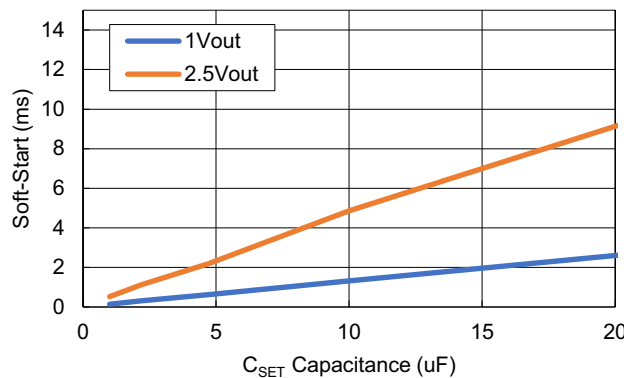

Figure 126. Start-Up Time vs C_{SET}, V_{IN} = 3.3V, C_{OUT} = 1×47µF + 2×1µF, I_{OUT} = 100mA

When using capacitor values larger than 1µF, the dielectric absorption effect can be more noticeable because large value capacitors can have more dielectric absorption. Furthermore, the droop noticeably takes longer to recover because the LDO has switched over to the normal regulation circuitry and therefore does not have the benefit of fast charging from the fast-start circuitry.

6.11 Power Dissipation and Thermals

To ensure reliable operation, the die junction temperature (T_J) of the RAA214023 must not exceed +125°C. In applications with high ambient temperature (T_A), large headroom voltages (V_{HEADROOM}), and large load currents (I_{OUT}), the heat dissipated in the package can become large enough to cause the T_J to exceed the maximum operating temperature of +125°C.

6.11.1 Power Dissipation

The Power Dissipation (PD) is calculated using [Equation 10](#).

$$\text{(EQ. 10)} \quad P_D = (V_{\text{IN}} - V_{\text{OUT}}) \times I_{\text{OUT}} + V_{\text{IN}} \times I_Q(V_{\text{IN}})$$

Because the power dissipation contribution from the quiescent (or ground current) is typically small compared to the current the LDO needs to supply to a load, it can be ignored and [Equation 10](#) simplifies to [Equation 11](#).

$$\text{(EQ. 11)} \quad P_D = (V_{\text{IN}} - V_{\text{OUT}}) \times I_{\text{OUT}}$$

Therefore, to lower the power dissipated inside the die, the V_{HEADROOM} and/or the I_{OUT} can be decreased.

6.11.2 The Junction Temperature and Thermal Resistance

The junction temperature (T_J) is the sum of the environmental ambient temperature (T_A) and the temperature rise in the T_J because of power dissipation, which is calculated using [Equation 12](#) if the ambient temperature, Power Dissipation, and θ_{JA} are known.

$$\text{(EQ. 12)} \quad T_J = T_A + \theta_{JA} \times PD$$

The θ_{JA} is the thermal resistance between the junction temperature and ambient temperature and is largely dependent on the device package and the PCB design. The θ_{JA} includes the thermal resistance of the junction to the bottom thermal pad ($\theta_{JC(\text{BOTTOM})}$) and the resistance of the junction to the top of the package ($\theta_{JC(\text{TOP})}$). These two thermal resistances are determined by the package features, dimensions, areas, thicknesses, and materials and therefore are fixed.

The remaining thermal resistance that makes up θ_{JA} largely depends on the total PCB copper area, copper weight, location of the thermal planes, and location of the IC on the PCB, amongst other things. Therefore, to compare the θ_{JA} of different products it is important to ensure the PCB layouts are similar, which is why the JEDEC standard exists.

6.12 Layout Guidelines

The following are recommendations for the RAA214023 to achieve optimal performance

- Place all the required components for the RAA214023 on the same layer as the IC.
- Place a minimum capacitance of 10µF ceramic input capacitor to the VIN and GND pins of the LDO as close as practical.
- Place a minimum capacitance of 22µF ceramic output capacitor to the VOUT and GND pins of the LDO as close as practical
- The package thermal EPAD is the largest heat conduction path for the package. It should be soldered to a copper pad on the PCB underneath the part. The PCB thermal pad should have as many plated vias to increase the heat flow from the package thermal EPAD to the inner PCB areas and/or the bottom PCB area. Keep the vias small but not so small that their inside diameter prevents solder from wicking through the holes during re-flow. For efficient heat transfer, it is important that the vias have low thermal resistance. Do not use thermal relief patterns to connect the vias. It is important to have a complete connection of the plated through-hole to each plane. The top copper GND layer, that the EPAD is connected to is the least thermally resistant path for heat flow. To this end, minimize the components and traces that cut this layer.

Figure 127 illustrates the recommended layout scheme.

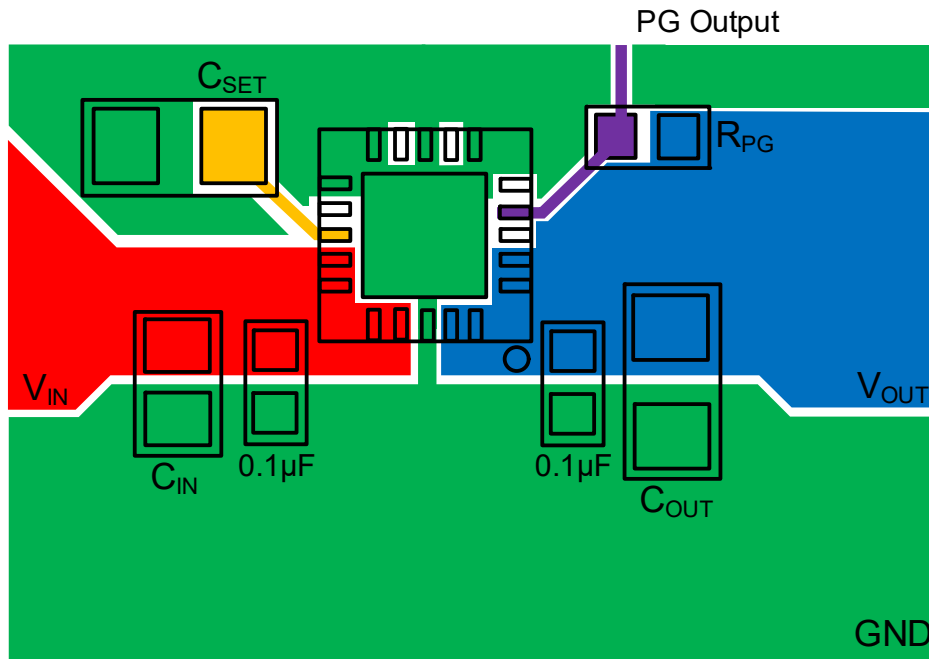

Figure 127. Layout Scheme

7. SPICE Model

The model is a simplified version of the actual device and simulates important AC and DC parameters. AC parameters incorporated into the model are: 1/f and flatband noise, PSRR, Gain, and Phase. The DC parameters are output voltage accuracy, dropout voltage, fast mode startup, and output current limit. The model uses typical parameters given in the [Electrical Specifications](#). The input stage models the actual device to present an accurate AC representation. The model is configured for ambient temperature of +25°C.

Figure 128 through Figure 129 show the characterization vs simulation results for the PSRR and Noise Voltage.

The spice model can be found at [RAA214023](#). The website provides the subcircuit.opj file with built in test circuits. Also included is the validation data of the model.

7.1 Characterization vs Simulation Results

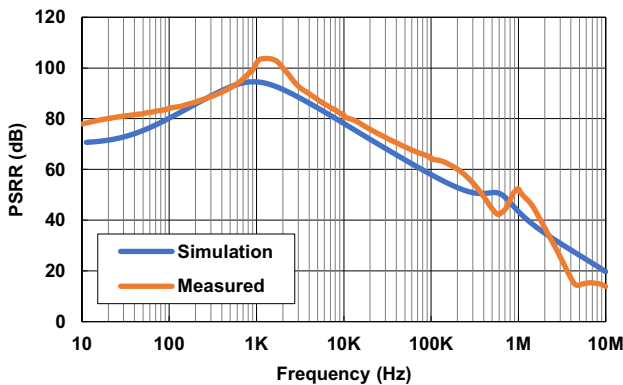

Figure 128. PSRR vs Frequency for SPICE Compared to Measured Results ($V_{IN} = 5V$, $V_{OUT} = 3.3V$, $I_{OUT} = 2A$, $C_{SET} = 1\mu F$, $C_{OUT} = 22\mu F$)

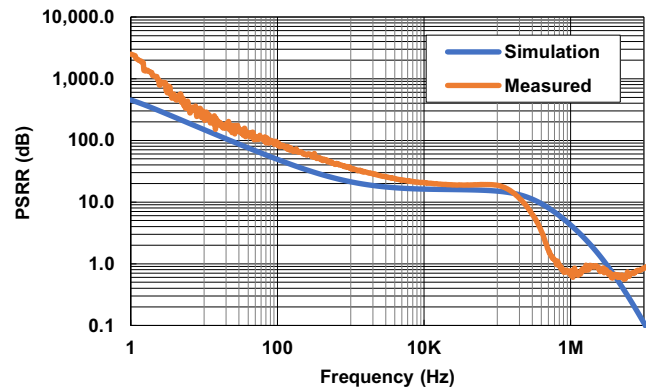

Figure 129. Output Noise vs Frequency for SPICE Compared to Measured Results ($V_{IN} = 5V$, $V_{OUT} = 3.3V$, $I_{OUT} = 2A$, $C_{SET} = 1\mu F$, $C_{OUT} = 22\mu F$)

8. Package Outline Drawings

For the most recent package outline drawing, see [L20.3.5x3.5](#).

L20.3.5x3.5

20 Lead Quad Flat No-Lead Package (QFN)

Rev 0, 10/20

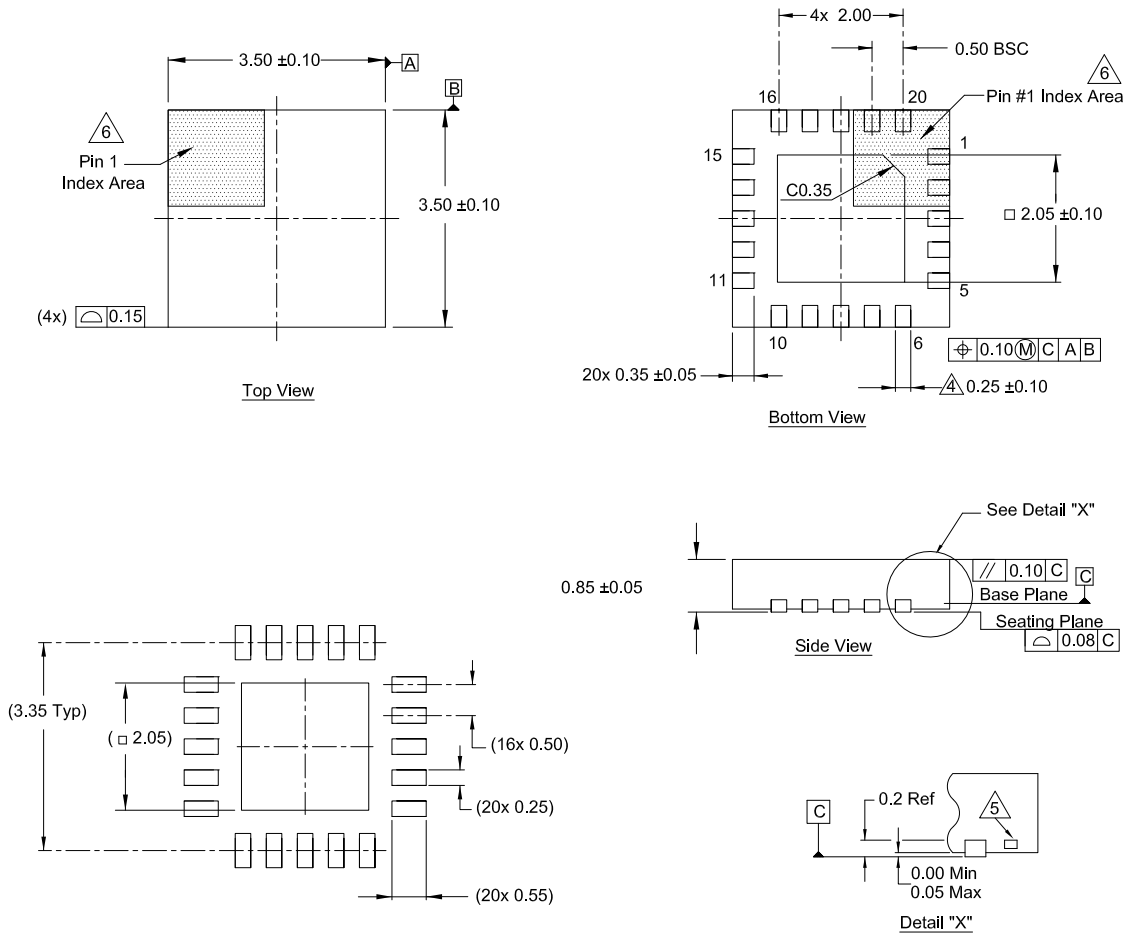

Notes:

1. Dimensions are in millimeters.
Dimensions in () for reference only.
2. Dimensioning and tolerancing conform to ASME Y14.5m-1994.
3. Unless otherwise specified, tolerance: Decimal ± 0.05
- ④ Dimension applies to the metallized terminal and is measured between 0.15mm and 0.30mm from the terminal tip.
- ⑤ Tiebar shown (if present) is a non-functional feature.
- ⑥ The configuration of the pin #1 identifier is optional, but must be located within the zone indicated. The pin #1 identifier is either a mold or mark feature.

For the most recent package outline drawing, see [L20.5x5B](#).

L20.5x5B
 20 Lead Quad Flat No-Lead Plastic Package
 Rev 0, 6/20

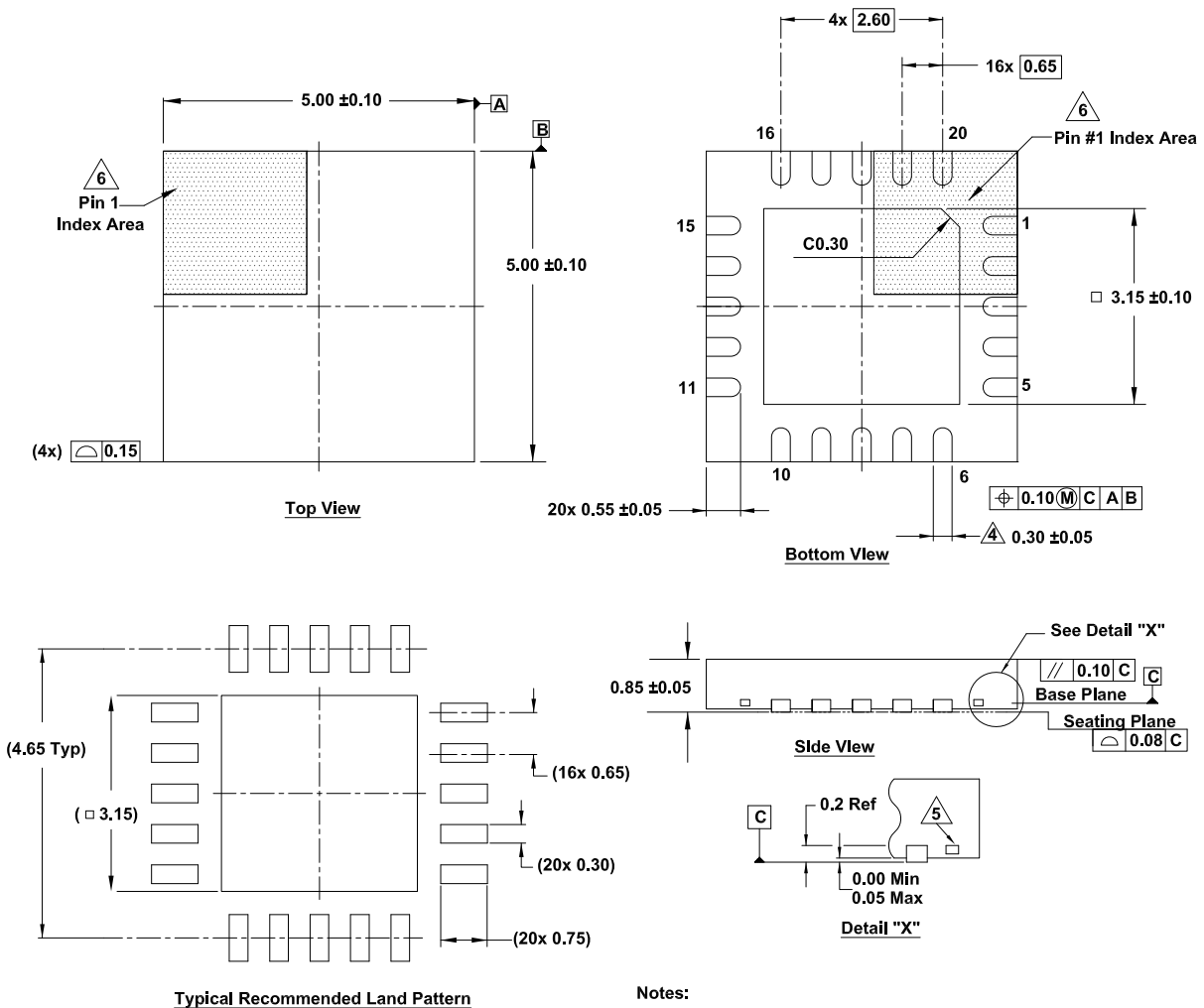

- Notes:
- Dimensions are in millimeters.
 Dimensions in () for reference only.
 - Dimensioning and tolerancing conform to ASME Y14.5m-1994.
 - Unless otherwise specified, tolerance: Decimal ± 0.05
 - $\triangle 4$ Dimension applies to the metallized terminal and is measured between 0.15mm and 0.30mm from the terminal tip.
 - $\triangle 5$ Tiebar shown (if present) is a non-functional feature.
 - $\triangle 6$ The configuration of the pin #1 identifier is optional, but must be located within the zone indicated. The pin #1 identifier may be either a mold or mark feature.

9. Ordering Information

Part Number ^{[1][2]}	Part Marking	Package Description (RoHS Compliant)	Pkg. Dwg. #	Carrier Type ^[3]	Temp. Range
RAA214023GNP#HC0	RAA214023	20 Ld QFN	L20.5×5B	Reel, 6k	-40 to +125°C
RAA214023GNP#HCA			L20.3.5×3.5		
RTKA214023DE0000BU	Evaluation Board				

1. These Pb-free plastic packaged products employ special Pb-free material sets; molding compounds/die attach materials and NiPdAu-Ag plate - e4 termination finish, which is RoHS compliant and compatible with both SnPb and Pb-free soldering operations. Pb-free products are MSL classified at Pb-free peak reflow temperatures that meet or exceed the Pb-free requirements of IPC/JEDEC J-STD-020.
2. For the Moisture Sensitivity Level (MSL), see the Product Options on the [RAA214023](#) product page (click the packaging icon). For more information about MSL, see [TB363](#).
3. See [TB347](#) for details about reel specifications.

Table 4. Key Differences Between Family of Parts

Part Number	Minimum V _{OUT} (V)	Output Voltage Adjustable	Package
RAA214020	0.9	Yes, through External Feedback Resistors	3 × 3mm 10 Ld DFN
RAA214023	0.8	Yes, through External Feedback Resistors or convenient IC pins	3.5 × 3.5 mm 20 Ld QFN or 5 × 5 mm 20 Ld QFN

10. Revision History

Rev.	Date	Description
2.02	Feb 3, 2023	Updated Start-up Time section.
2.01	Mar 10, 2022	Updated Figures 116 and 118.
2.00	Jan 25, 2022	Updated the ESD values from 2kV to 3kV for HBM and 1.5kV to 1.25k for CDM.
1.02	Oct 11, 2021	Updated ordering information table to include the correct part numbers being offered.
1.01	Sep 29, 2021	Updated description on page 1. Updated low output noise typical value throughout from 6.3 to 6.5 Updated PSRR feature bullets. Updated Figure 2 Updated HBM ESD value. Updated Ultra-Low Output Noise and Enable Control sections.
1.00	Sep 15, 2021	Initial release

IMPORTANT NOTICE AND DISCLAIMER

RENESAS ELECTRONICS CORPORATION AND ITS SUBSIDIARIES (“RENESAS”) PROVIDES TECHNICAL SPECIFICATIONS AND RELIABILITY DATA (INCLUDING DATASHEETS), DESIGN RESOURCES (INCLUDING REFERENCE DESIGNS), APPLICATION OR OTHER DESIGN ADVICE, WEB TOOLS, SAFETY INFORMATION, AND OTHER RESOURCES “AS IS” AND WITH ALL FAULTS, AND DISCLAIMS ALL WARRANTIES, EXPRESS OR IMPLIED, INCLUDING, WITHOUT LIMITATION, ANY IMPLIED WARRANTIES OF MERCHANTABILITY, FITNESS FOR A PARTICULAR PURPOSE, OR NON-INFRINGEMENT OF THIRD PARTY INTELLECTUAL PROPERTY RIGHTS.

These resources are intended for developers skilled in the art designing with Renesas products. You are solely responsible for (1) selecting the appropriate products for your application, (2) designing, validating, and testing your application, and (3) ensuring your application meets applicable standards, and any other safety, security, or other requirements. These resources are subject to change without notice. Renesas grants you permission to use these resources only for development of an application that uses Renesas products. Other reproduction or use of these resources is strictly prohibited. No license is granted to any other Renesas intellectual property or to any third party intellectual property. Renesas disclaims responsibility for, and you will fully indemnify Renesas and its representatives against, any claims, damages, costs, losses, or liabilities arising out of your use of these resources. Renesas' products are provided only subject to Renesas' Terms and Conditions of Sale or other applicable terms agreed to in writing. No use of any Renesas resources expands or otherwise alters any applicable warranties or warranty disclaimers for these products.

(Disclaimer Rev.1.0 Mar 2020)

Corporate Headquarters

TOYOSU FORESIA, 3-2-24 Toyosu,
Koto-ku, Tokyo 135-0061, Japan
www.renesas.com

Contact Information

For further information on a product, technology, the most up-to-date version of a document, or your nearest sales office, please visit:
www.renesas.com/contact/

Trademarks

Renesas and the Renesas logo are trademarks of Renesas Electronics Corporation. All trademarks and registered trademarks are the property of their respective owners.

X-ON Electronics

Largest Supplier of Electrical and Electronic Components

Click to view similar products for [LDO Voltage Regulators](#) category:

Click to view products by [Renesas](#) manufacturer:

Other Similar products are found below :

[AP7363-SP-13](#) [NCV8664CST33T3G](#) [L79M05TL-E](#) [AP7362-HA-7](#) [PT7M8202B12TA5EX](#) [TCR3DF185,LM\(CT](#) [TLF4949EJ](#)
[NCP4687DH15T1G](#) [NCV8703MX30TCG](#) [LP2951CN](#) [NCV4269CPD50R2G](#) [AP7315-25W5-7](#) [NCV47411PAAJR2G](#) [AP2111H-1.2TRG1](#)
[ZLDO1117QK50TC](#) [AZ1117ID-ADJTRG1](#) [NCV4263-2CPD50R2G](#) [NCP706ABMX300TAG](#) [NCP114BMX075TCG](#) [MC33269T-3.5G](#)
[TLE4471GXT](#) [AP7315-33SA-7](#) [NCV4266-2CST33T3G](#) [NCP715SQ15T2G](#) [NCV8623MN-50R2G](#) [NCV563SQ18T1G](#) [NCV8664CDT33RKG](#)
[NCV4299CD250R2G](#) [NCP715MX30TBG](#) [NCV8702MX25TCG](#) [TLE7270-2E](#) [NCV562SQ25T1G](#) [AP2213D-3.3TRG1](#) [AP2202K-2.6TRE1](#)
[NCV8170BMX300TCG](#) [NCV8152MX300180TCG](#) [NCP700CMT45TBG](#) [AP7315-33W5-7](#) [NCP154MX180300TAG](#) [AP2113AMTR-G1](#)
[N JW4104U2-33A-TE1](#) [MP2013AGG-5-P](#) [NCV8775CDT50RKG](#) [NJM2878F3-45-TE1](#) [S-19214B00A-V5T2U7](#) [S-19214B50A-V5T2U7](#) [S-](#)
[19213B50A-V5T2U7](#) [S-19214BC0A-E8T1U7*1](#) [S-19213B00A-V5T2U7](#) [S-19213B33A-V5T2U7](#)