

# RAA214401

150mA Wide Input Range Ultra Low Quiescent Current Linear Regulator

The RAA214401 is a linear regulator that operates with a wide input voltage range at a fixed output at 3.3V and up to 150mA of output current. With an ultra low quiescent current, it is suitable for always-on and keep-alive applications.

The device operates with a wide input voltage range (4.5V to 40V at 1mA load) with excellent line and load regulation. It has integrated fault protections such as Over-Temperature Shutdown (OTSD) and short-circuit current limit.

The output voltage of the device is well regulated across temperature and the entire operating range of the input voltage and load. It is fixed with an internal resistor network between the output pin and ground.

The RAA214401 is available in a SOT23 package.

## Features

- Wide input voltage range (4.5V to 40V at 1mA load)
- Ultra low 3.6µA quiescent current
- High output voltage accuracy
- Excellent line and load regulation
- Stable with 2.2µF - 200µF MLCC output capacitor
- Integrated fault protections including thermal shutdown and current limit
- Available in the compact and cost-effective SOT23 package

## Applications

- Always-on battery-powered equipment
- MCU standby power supply
- Electric meters
- Laptop computers and tablets
- Portable modules and appliances

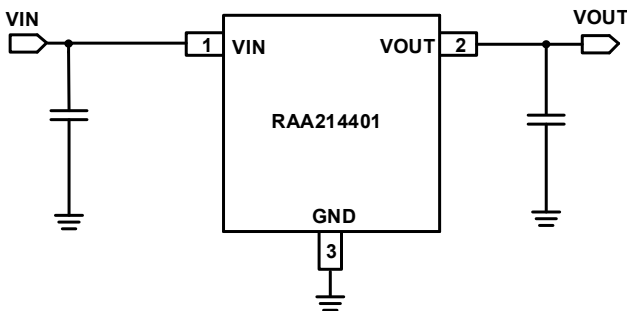

Figure 1. RAA214401 Typical Application

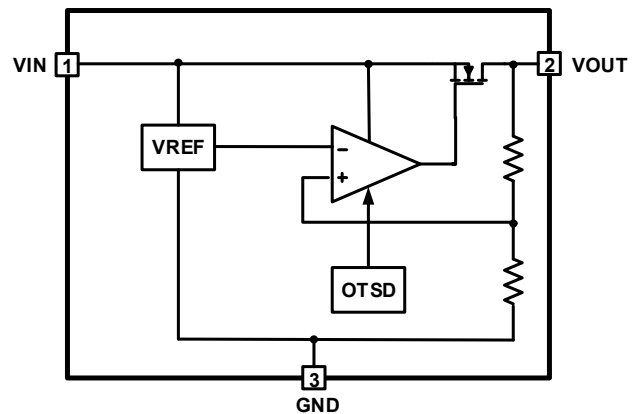

Figure 2. RAA214401 Block Diagram

## Contents

<b>1. Pin Information</b>	<b>3</b>
1.1 Pin Assignments	3
1.2 Pin Descriptions	3
<b>2. Specifications</b>	<b>4</b>
2.1 Absolute Maximum Ratings	4
2.2 Thermal Information	4
2.3 Recommended Operating Conditions	4
2.4 Electrical Specifications	5
<b>3. Typical Performance Graphs</b>	<b>6</b>
<b>4. Function Description</b>	<b>9</b>
4.1 Function Overview	9
4.2 Current Limit Protection	9
4.3 Over-Temperature Shutdown (OTSD)	9
4.4 Transient Response	9
<b>5. Application Information</b>	<b>9</b>
5.1 Input and Output Capacitors	9
5.2 Power Dissipation	9
5.3 Minimum Supply Voltage	10
5.4 PCB Layout Recommendations	11
<b>6. Package Outline Drawing</b>	<b>12</b>
<b>7. Ordering Information</b>	<b>13</b>
<b>8. Revision History</b>	<b>13</b>

# 1. Pin Information

## 1.1 Pin Assignments

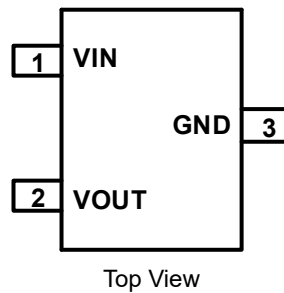

## 1.2 Pin Descriptions

Pin Name	Pin Number	Description
VIN	1	Analog input supply voltage and positive supply for the linear regulator. Decouple this pin to ground with a 0.1 $\mu$ F or larger high frequency ceramic capacitor to GND.
VOUT	2	Regulated output voltage pin. An output MLCC capacitor is needed between this pin and GND. Place the capacitor as close to the output of the regulator as possible.
GND	3	Ground reference.

## 2. Specifications

### 2.1 Absolute Maximum Ratings

**CAUTION:** Do not operate at or near the maximum ratings listed for extended periods of time. Exposure to such conditions can adversely impact product reliability and result in failures not covered by warranty.

Parameter <sup>[1]</sup>	Minimum	Maximum	Unit
Supply Voltage, VIN	-0.3	+45	V
Output Voltage, VOUT	-0.3	6	V
Output Current, IOUT		Internally Limited	
ESD Ratings	Value		Unit
Human Body Model (Tested per JS-001-2017)	2		kV
Charged Device Model (Tested per JS-002-2014)	750		V
Latch-Up (Tested per JESD78E; Class 2, Level A)	100		mA

1. All voltages referenced to VSS unless otherwise specified.

### 2.2 Thermal Information

Thermal Resistance (Typical) <sup>[1]</sup>	$\theta_{JA}$ (°C/W) <sup>[2]</sup>	$\theta_{JC}$ (°C/W) <sup>[3]</sup>
SOT23	275	120

1. Specified at published junction-to-ambient thermal resistance for a junction temperature of +150°C. See Theta JA note for test condition to establish junction-to-ambient thermal resistance.
2.  $\theta_{JA}$  is measured with the component mounted on a high-effective thermal conductivity test board in free air. See [TB379](#).
3. For  $\theta_{JC}$ , the case temperature location is on the top of the package.

Parameter	Minimum	Maximum	Unit
Maximum Junction Temperature	-65	+150	°C
Maximum Storage Temperature Range	-55	+150	°C
Pb-Free Reflow Profile	See <a href="#">TB493</a>		

### 2.3 Recommended Operating Conditions

Parameter <sup>[1]</sup>	Minimum	Maximum	Unit
Supply Voltage, V <sub>DD</sub>	+4.9 <sup>[2]</sup>	+40	V
Output Capacitor, C <sub>OUT</sub>	2.2	200	uF
Junction Temperature	-40°C	+125	°C

1. All voltages referenced to VSS unless otherwise specified.
2. Minimum supply voltage at 150mA load. See [Figure 19](#) for the minimum supply voltage at other loads.

## 2.4 Electrical Specifications

At internal junction temperature  $-40^{\circ}\text{C}$  to  $+125^{\circ}\text{C}$ ,  $V_{\text{IN}} = 6\text{V}$ ;  $C_{\text{IN}} = 1\mu\text{F}$ ;  $C_{\text{OUT}} = 2.2\mu\text{F}$ , unless otherwise specified. Typical values are at  $T_{\text{A}} = 25^{\circ}\text{C}$ .

Parameters	Symbol	Test Conditions	Min <sup>[1]</sup>	Typ	Max <sup>[1]</sup>	Unit
Input Voltage	$V_{\text{IN}}$	$I_{\text{OUT}} = 1\text{mA}$	4.5		40	V
		$I_{\text{OUT}} = 150\text{mA}$	4.9		40	
Output Voltage	$V_{\text{OUT}}$		3.20	3.30	3.39	V
Ground Current	$I_{\text{GND}}$	$V_{\text{IN}} = 6\text{V}$ , $I_{\text{OUT}} = 0$		3.6	5.5	$\mu\text{A}$
		$V_{\text{IN}} = 40\text{V}$ , $I_{\text{OUT}} = 0$			6.1	$\mu\text{A}$
		$V_{\text{IN}} = 6\text{V}$ , $I_{\text{OUT}} = 100\text{mA}$		48		$\mu\text{A}$
		$V_{\text{IN}} = 6\text{V}$ , $I_{\text{OUT}} = 150\text{mA}$		51		$\mu\text{A}$
Line Regulation	$DV_{\text{OUT}}$	$4.5\text{V} \leq V_{\text{IN}} \leq 40\text{V}$ , $I_{\text{OUT}} = 1\text{mA}$		0.0003	0.005	%/V
Load Regulation	$DV_{\text{OUT}}$	0.1mA to 150mA		0.0025	0.006	%/mA
Dropout Voltage <sup>[2]</sup>	$V_{\text{DO}}$	$I_{\text{OUT}} = 10\text{mA}$		0.96	1.32	V
		$I_{\text{OUT}} = 20\text{mA}$		1.02	1.35	V
		$I_{\text{OUT}} = 100\text{mA}$		1.27	1.53	V
		$I_{\text{OUT}} = 150\text{mA}$		1.37	1.6	V
Output Voltage Temperature Coefficient		$4.5\text{V} \leq V_{\text{IN}} \leq 40\text{V}$ , $I_{\text{OUT}} = 1\text{mA}$		32		ppm/ $^{\circ}\text{C}$
Output Voltage Noise	$V_{\text{n}}$	10Hz to 100kHz, $I_{\text{OUT}} = 10\text{mA}$		237		$\mu\text{V}_{\text{RMS}}$
Power Supply Ripple Rejection Ratio	PSRR	10Hz, $I_{\text{OUT}} = 1\text{mA}$		77		dB
		100Hz, $I_{\text{OUT}} = 1\text{mA}$		74		dB
		1kHz, $I_{\text{OUT}} = 1\text{mA}$		52		dB
		10kHz, $I_{\text{OUT}} = 1\text{mA}$		42		dB
Startup Time	$t_{\text{STR}}$	Time from $V_{\text{DD}} = 5.4\text{V}$ to $V_{\text{OUT}} = 0.95 * V_{\text{OUT\_NOM}}$ , $I_{\text{OUT}} = 0$	370	470	670	$\mu\text{s}$
Short-Circuit Current Limit	$I_{\text{LIM}}$	$V_{\text{OUT}} = 1\text{V}$	150			mA
Thermal Shutdown		Temperature rising		155		$^{\circ}\text{C}$
Hysteresis				17.5		$^{\circ}\text{C}$

- Parameters with MIN and/or MAX limits are 100% tested at  $+25^{\circ}\text{C}$ , unless otherwise specified. Temperature limits established by characterization and are not production tested.
- $V_{\text{DO}}$  is measured at  $V_{\text{OUT}} = 0.98 \times V_{\text{OUT(nom)}}$

### 3. Typical Performance Graphs

Unless otherwise specified, operating conditions are at:  $T = +25^{\circ}\text{C}$ ;  $V_{\text{IN}} = 6\text{V}$ ,  $C_{\text{OUT}} = 2.2\mu\text{F}$

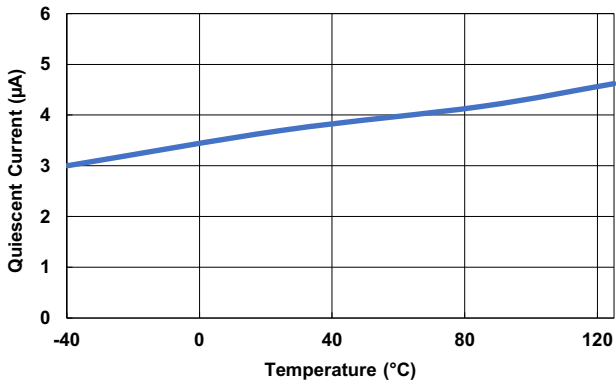

Figure 3. Quiescent Current (No Load) vs Temperature

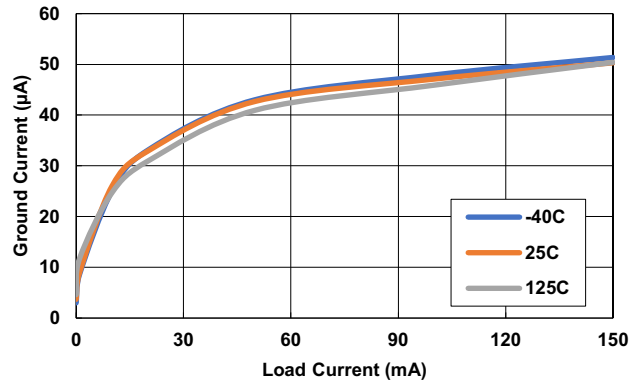

Figure 4. Ground Current vs Load

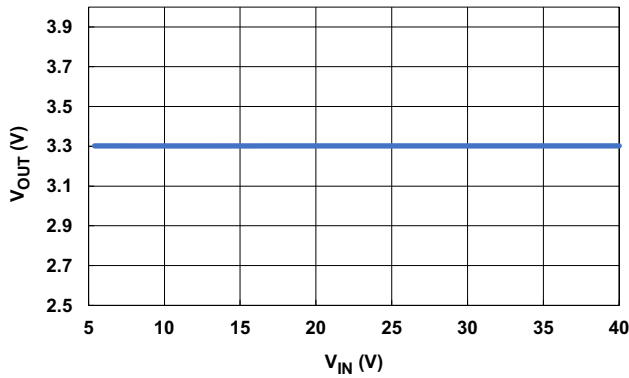

Figure 5. Output Voltage vs Input Voltage ( $I_{\text{OUT}} = 1\text{mA}$ )

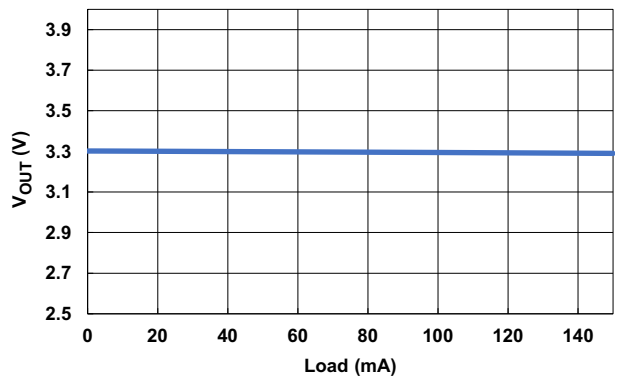

Figure 6. Output Voltage vs Load

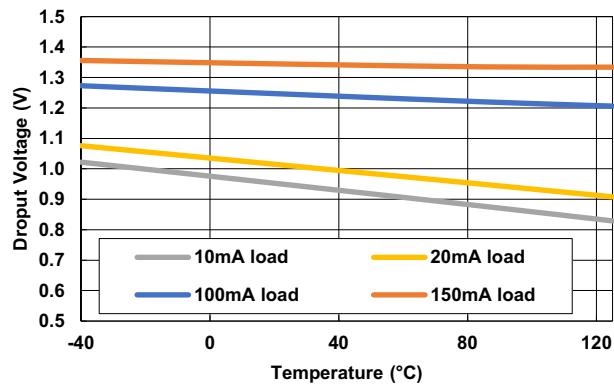

Figure 7. Dropout Voltage vs Temperature

Unless otherwise specified, operating conditions are at:  $T = +25^{\circ}\text{C}$ ;  $V_{\text{IN}} = 6\text{V}$ ,  $C_{\text{OUT}} = 2.2\mu\text{F}$  (Cont.)

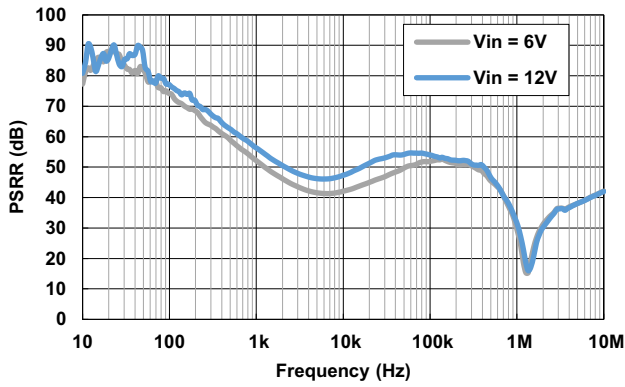

Figure 8. Power Supply Rejection Ratio ( $I_{\text{OUT}} = 1\text{mA}$ )

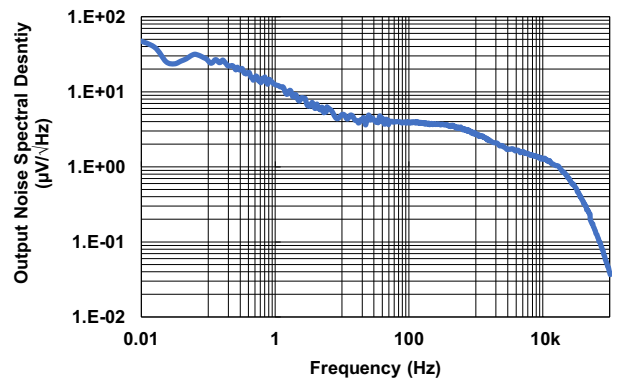

Figure 9. Output Noise Spectral Density ( $I_{\text{OUT}} = 10\text{mA}$ )

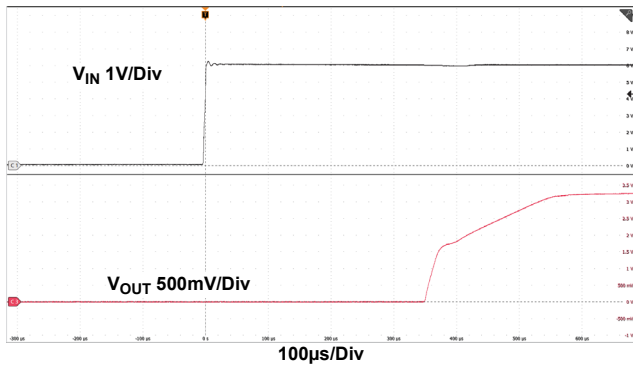

Figure 10. Startup Waveform ( $I_{\text{OUT}} = 10\text{mA}$ )

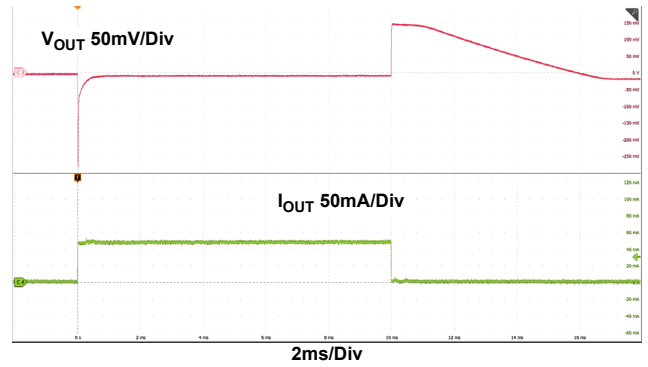

Figure 11. Load Transient Response (0 to 50mA)

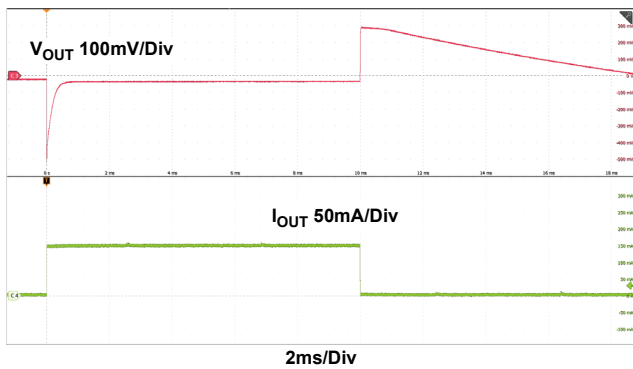

Figure 12. Load Transient Response (0 to 150mA)

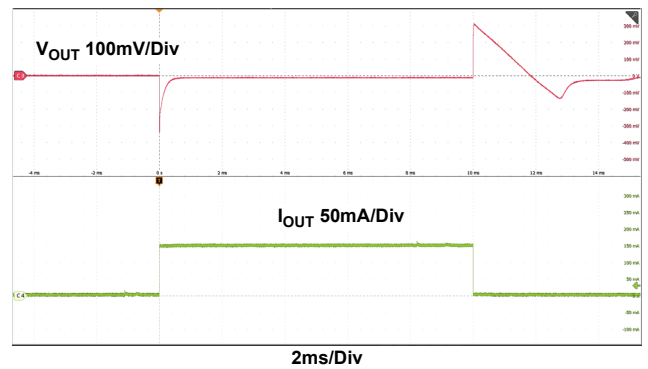

Figure 13. Load Transient Response (1mA to 150mA)

Unless otherwise specified, operating conditions are at:  $T = +25^{\circ}\text{C}$ ;  $V_{\text{IN}} = 6\text{V}$ ,  $C_{\text{OUT}} = 2.2\mu\text{F}$  (Cont.)

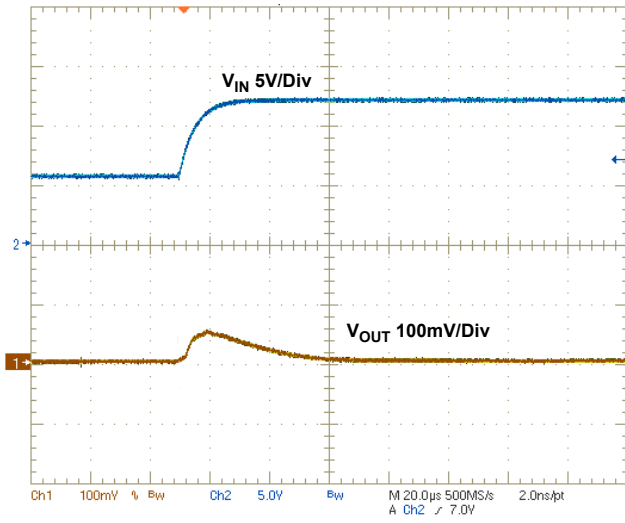

Figure 14. 6V to 12V Line Transient Response ( $I_{\text{OUT}} = 10\text{mA}$ )

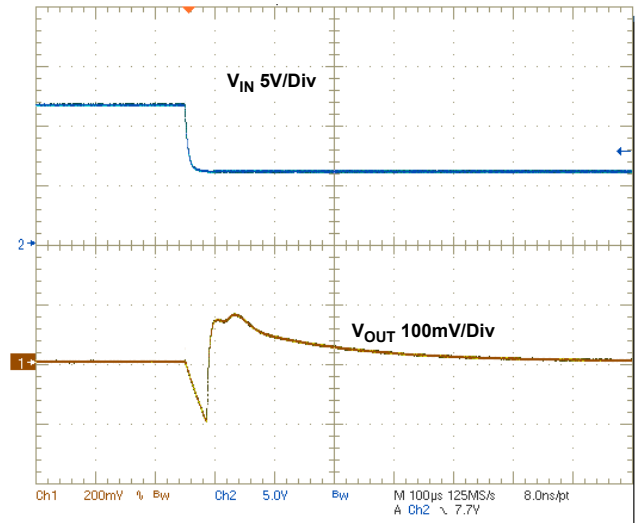

Figure 15. 12V to 6V Line Transient Response ( $I_{\text{OUT}} = 10\text{mA}$ )

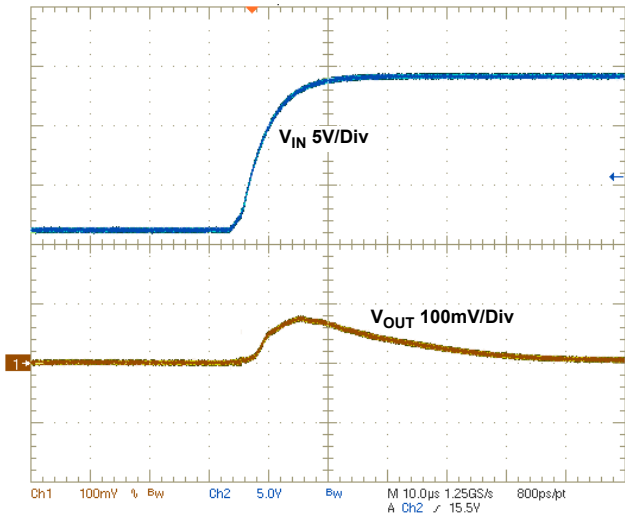

Figure 16. 12V to 24V Line Transient Response ( $I_{\text{OUT}} = 10\text{mA}$ )

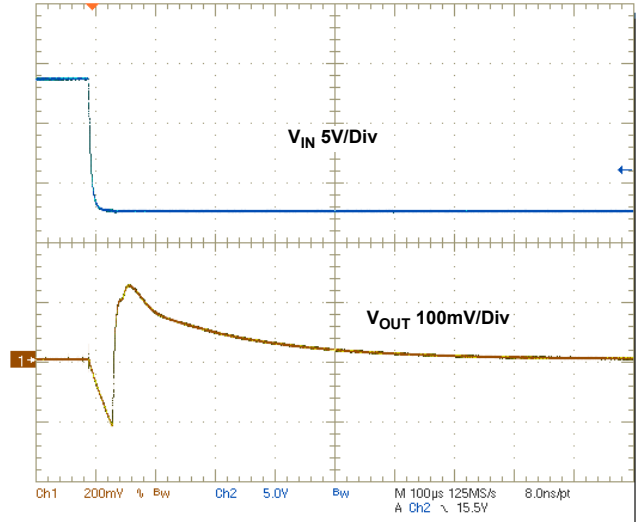

Figure 17. 24V to 12V Line Transient Response ( $I_{\text{OUT}} = 10\text{mA}$ )



## 4. Function Description

### 4.1 Function Overview

The RAA214401 is a high performance low dropout linear voltage regulator with 150mA sourcing capability. It operates at a wide input voltage range of 4.5V to 40V and regulates a precise and stable output voltage at 3.3V. With an ultra low quiescent current, it is an ideal choice for always-on applications. It works well under a load dump condition in which the input voltage could rise up to 40V.

### 4.2 Current Limit Protection

The RAA214401 has internal current limiting functionality to protect the regulator during fault conditions. During current limit, the output sources a fixed amount of current largely independent of the output voltage. If the short or overload is removed from  $V_{OUT}$ , the output returns to normal voltage regulation mode.

### 4.3 Over-Temperature Shutdown (OTSD)

If the die temperature exceeds the over-temperature threshold of the device, the output of the LDO shuts down until the die temperature cools down to a temperature determined by the hysteresis of the OTSD. The level of power dissipated, combined with the ambient temperature and the thermal impedance of the package, determines if the junction temperature exceeds the OTSD temperature.

### 4.4 Transient Response

The RAA214401 has excellent transient response to a load or line step. It can withstand a rapid change in load from zero to full load with minimal output capacitor required. It is also stable against fast transitions in the supply voltage, making it well suited for applications where two supplies are OR'ed into the regulator.

## 5. Application Information

### 5.1 Input and Output Capacitors

Renesas recommends connecting a 1 $\mu$ F ceramic capacitor between  $V_{IN}$  and GND at the input to reduce circuit sensitivity to the Printed Circuit Board (PCB) layout. As a minimum, place a 0.1 $\mu$ F ceramic capacitor at the input for proper operation. Higher capacitance improves the line transient response.

The device is stable with an output ceramic capacitor in the range of 2.2 $\mu$ F to 200 $\mu$ F. Higher capacitance can help improve line transient response and reduce noise.

For both the input and output capacitors, the X7R type is recommended because it has low capacitance variation across temperature.

### 5.2 Power Dissipation

The junction temperature must not exceed the range specified in [Recommended Operating Conditions](#). The power dissipation is calculated using [Equation 1](#).

$$(EQ. 1) \quad P_D = (V_{IN} - V_{OUT}) \times I_{OUT} + V_{IN} \times I_{GND}$$

To calculate the maximum ambient operating temperature, use the junction-to-ambient thermal resistance ( $\theta_{JA}$ ) as shown in [Equation 2](#), where  $T_{J(MAX)}$  is the maximum allowable junction temperature, and  $T_A$  is the ambient temperature.

$$(EQ. 2) \quad T_{J(MAX)} = P_{D(MAX)} \times \theta_{JA} + T_A$$

For any target junction temperature, the maximum load the IC allows decreases as the supply voltage increases. Given the thermal resistance  $\theta_{JA}$ , the [Equation 1](#) and [Equation 2](#) can be used to estimate the maximum load the IC supports up to its maximum junction temperature. The lower  $\theta_{JA}$  is, the more load the device can handle. To lower, apply large trace metal area and ground plane on the PCB. For example, the  $\theta_{JA}$  for this device measured on a PCB with 0.1 inch<sup>2</sup> ground trace area using 2oz copper is around 74°C/W. If the target maximum junction temperature is 125°C, [Figure 18](#) shows the maximum load allowed on this PCB across the input voltage range at the ambient temperature of 25°C, 55°C, and 85°C, respectively.

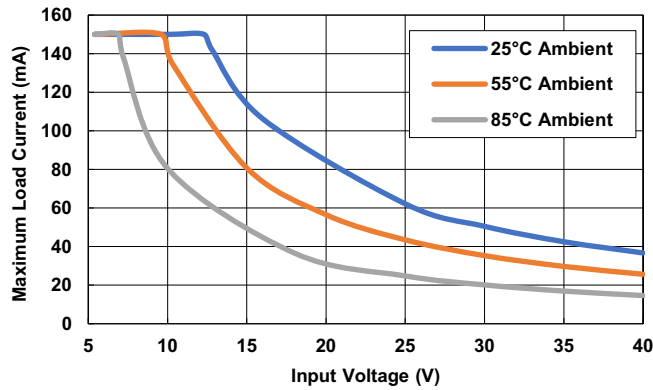

Figure 18. Maximum Allowable Load vs Input Voltage

### 5.3 Minimum Supply Voltage

The RAA214401 operates over a wide input voltage range up to 40V. Depending on the load current, the recommended minimum supply voltage can be found in [Figure 19](#).

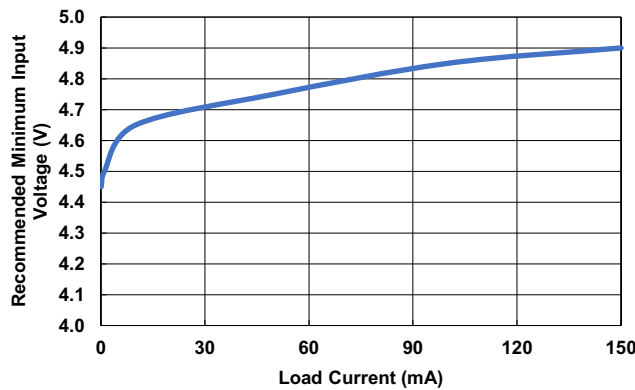

Figure 19. Recommended Minimum Input Voltage (V)

## 5.4 PCB Layout Recommendations

When placing components and routing the trace, minimize the ground impedance and keep the parasitic inductance low. Place the input and output capacitors as close to the IC as possible. VIN, VOUT, and GND traces should be reasonably wide to improve the thermal performance of the IC and to reduce the chance of noise pickup.

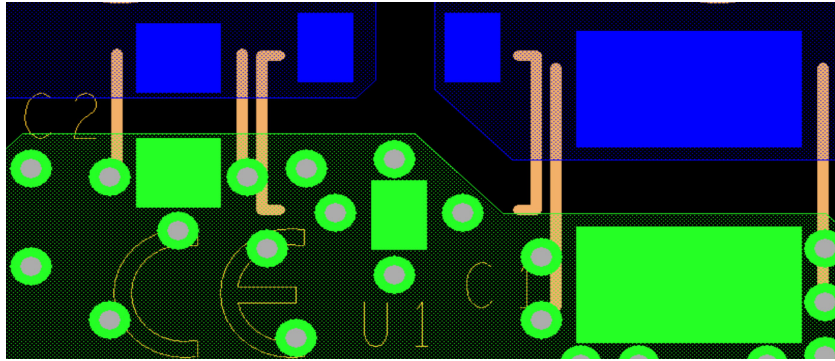
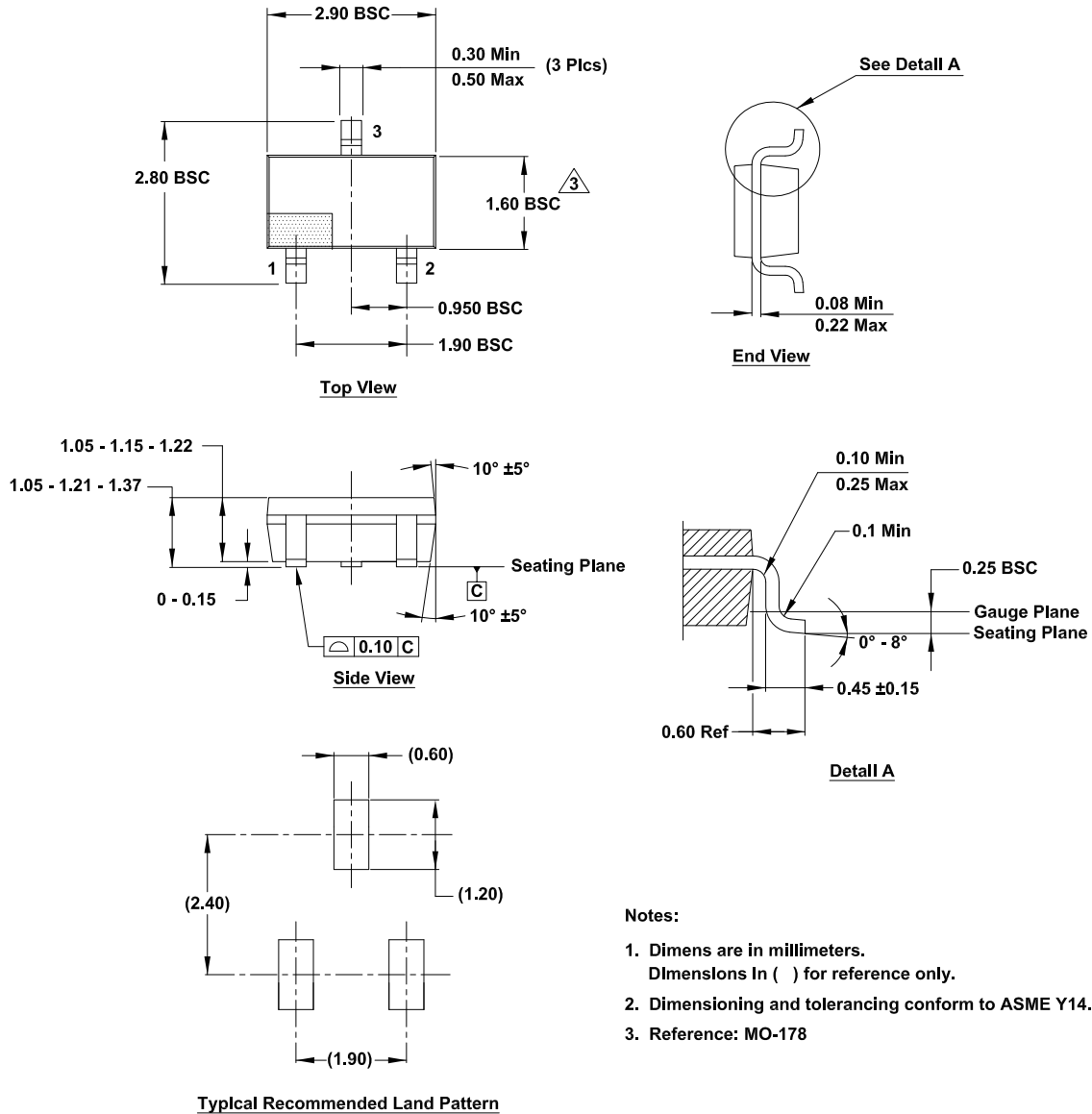

Figure 20. Recommended Capacitor Placement

## 6. Package Outline Drawing

For the most recent package outline drawing, see [P3.064B](#).

P3.064B  
 3 Lead Small Outline Transistor Plastic Package (SOT23-3)  
 Rev 1, 3/2021



## 7. Ordering Information

Part Number [1][2]	Part Marking[3]	Package Description (RoHS Compliant)	Pkg. Dwg. #	Carrier Type[4]	Temp. Range
RAA2144014GP3#NA0	401	3 Ld SOT23	P3.064B	Reel, 250	-40°C to 125°C
RAA2144014GP3#JA0				Reel, 3k	
RTKA214401DR0000BU	Evaluation Board				

1. These Pb-free plastic packaged products employ special Pb-free material sets, molding compounds/die attach materials, and 100% matte tin plate plus anneal (e3 termination finish, which is RoHS compliant and compatible with both SnPb and Pb-free soldering operations). Pb-free products are MSL classified at Pb-free peak reflow temperatures that meet or exceed the Pb-free requirements of IPC/JEDEC J STD-020.
2. For Moisture Sensitivity Level (MSL), see the [RAA214401](#) device page. For more information about MSL, see [TB363](#).
3. The part marking is located on the bottom of the part.
4. See [TB347](#) for details about reel specifications.

## 8. Revision History

Rev	Date	Description
2.01	Oct 6, 2022	Updated Figure 17.
2.00	Jul 22, 2022	Updated file number. Updated Line Regulation and Load Regulation specifications by swapping values. Updated POD P3.064B to the latest revision, changes are as follows: <ul style="list-style-type: none"> <li>▪ Updated Total Pkg Height from 1.45 Max to 1.05 - 1.21 - 1.37</li> <li>▪ Updated Standoff Height from 0.15 Max to 0-0.15</li> <li>▪ Updated Body Thickness from 1.15 +0.15/-0.25 to 1.05 - 1.15 - 1.22</li> </ul>
1.01	Jun 7, 2021	Updated Line Regulation maximum specification from 0.004 to 0.006.
1.00	Mar 3, 2021	Initial release

## IMPORTANT NOTICE AND DISCLAIMER

RENESAS ELECTRONICS CORPORATION AND ITS SUBSIDIARIES (“RENESAS”) PROVIDES TECHNICAL SPECIFICATIONS AND RELIABILITY DATA (INCLUDING DATASHEETS), DESIGN RESOURCES (INCLUDING REFERENCE DESIGNS), APPLICATION OR OTHER DESIGN ADVICE, WEB TOOLS, SAFETY INFORMATION, AND OTHER RESOURCES “AS IS” AND WITH ALL FAULTS, AND DISCLAIMS ALL WARRANTIES, EXPRESS OR IMPLIED, INCLUDING, WITHOUT LIMITATION, ANY IMPLIED WARRANTIES OF MERCHANTABILITY, FITNESS FOR A PARTICULAR PURPOSE, OR NON-INFRINGEMENT OF THIRD PARTY INTELLECTUAL PROPERTY RIGHTS.

These resources are intended for developers skilled in the art designing with Renesas products. You are solely responsible for (1) selecting the appropriate products for your application, (2) designing, validating, and testing your application, and (3) ensuring your application meets applicable standards, and any other safety, security, or other requirements. These resources are subject to change without notice. Renesas grants you permission to use these resources only for development of an application that uses Renesas products. Other reproduction or use of these resources is strictly prohibited. No license is granted to any other Renesas intellectual property or to any third party intellectual property. Renesas disclaims responsibility for, and you will fully indemnify Renesas and its representatives against, any claims, damages, costs, losses, or liabilities arising out of your use of these resources. Renesas' products are provided only subject to Renesas' Terms and Conditions of Sale or other applicable terms agreed to in writing. No use of any Renesas resources expands or otherwise alters any applicable warranties or warranty disclaimers for these products.

(Rev.1.0 Mar 2020)

### Corporate Headquarters

TOYOSU FORESIA, 3-2-24 Toyosu,  
Koto-ku, Tokyo 135-0061, Japan  
[www.renesas.com](http://www.renesas.com)

### Contact Information

For further information on a product, technology, the most up-to-date version of a document, or your nearest sales office, please visit:  
[www.renesas.com/contact/](http://www.renesas.com/contact/)

### Trademarks

Renesas and the Renesas logo are trademarks of Renesas Electronics Corporation. All trademarks and registered trademarks are the property of their respective owners.

## X-ON Electronics

Largest Supplier of Electrical and Electronic Components

*Click to view similar products for [LDO Voltage Regulators](#) category:*

*Click to view products by [Renesas](#) manufacturer:*

Other Similar products are found below :

[AP7363-SP-13](#) [NCV8664CST33T3G](#) [L79M05TL-E](#) [AP7362-HA-7](#) [PT7M8202B12TA5EX](#) [TCR3DF185,LM\(CT](#) [TLF4949EJ](#)  
[NCP4687DH15T1G](#) [NCV8703MX30TCG](#) [LP2951CN](#) [NCV4269CPD50R2G](#) [AP7315-25W5-7](#) [NCV47411PAAJR2G](#) [AP2111H-1.2TRG1](#)  
[ZLDO1117QK50TC](#) [AZ1117ID-ADJTRG1](#) [NCV4263-2CPD50R2G](#) [NCP706ABMX300TAG](#) [NCP114BMX075TCG](#) [MC33269T-3.5G](#)  
[TLE4471GXT](#) [AP7315-33SA-7](#) [NCV4266-2CST33T3G](#) [NCP715SQ15T2G](#) [NCV8623MN-50R2G](#) [NCV563SQ18T1G](#) [NCV8664CDT33RKG](#)  
[NCV4299CD250R2G](#) [NCP715MX30TBG](#) [NCV8702MX25TCG](#) [TLE7270-2E](#) [NCV562SQ25T1G](#) [AP2213D-3.3TRG1](#) [AP2202K-2.6TRE1](#)  
[NCV8170BMX300TCG](#) [NCV8152MX300180TCG](#) [NCP700CMT45TBG](#) [AP7315-33W5-7](#) [NCP154MX180300TAG](#) [AP2113AMTR-G1](#)  
[NJW4104U2-33A-TE1](#) [MP2013AGG-5-P](#) [NCV8775CDT50RKG](#) [NJM2878F3-45-TE1](#) [S-19214B00A-V5T2U7](#) [S-19214B50A-V5T2U7](#) [S-](#)  
[19213B50A-V5T2U7](#) [S-19214BC0A-E8T1U7\\*1](#) [S-19213B00A-V5T2U7](#) [S-19213B33A-V5T2U7](#)