

## RTKA210130DE0010BU

The [RAA210130](#) is a 30A synchronous step-down DC/DC converter power module with integrated digital PWM controller, smart power stage (SPS), output inductor and passive components. The RTKA210130DE0010BU is a socket board used for programming the RAA210130 (shown in [Figure 11](#)).

The RTKA210130DE0010BU socket board is a 4.4in x 5.0in 6-layer FR4 board with 2oz. copper on all layers. Use this board together with the ISLUSBEVAL1Z dongle and USB cable for connection between the dongle and the computer. The Renesas PowerNavigator™ can be used together with this board to configure and program the RAA210130 device.

This manual highlights the procedure to program the RAA210130 module using the RTKA210130DE0010BU socket board. For details about the RAA210130 power module, see the [RAA210130 Datasheet](#).

### Features

- Socket board for programming the RAA210130

### Specifications

The socket board is to be used under the following conditions:

- $V_{IN} = 4.75V$  to  $15V$
- $V_{OUT} = 0.6 - 3.0V$
- $I_{OUT-MAX} = 0A$

## Contents

<b>1. Functional Description</b> .....	<b>3</b>
1.1 Setup and Configuration .....	3
<b>2. Board Design</b> .....	<b>8</b>
2.1 Schematic Diagram .....	10
2.2 Bill of Materials .....	11
2.3 Board Layout .....	12
<b>3. Ordering Information</b> .....	<b>16</b>
<b>4. Revision History</b> .....	<b>16</b>

# 1. Functional Description

The RTKA210130DE0010BU provides the peripheral circuitry to program the RAA210130. Connecting a jumper between pin 1 and 2 of the VIN\_CONNECTOR, allows using VIN to power the internal analog 5V and 3.3V supplies. Figure 11 and Figure 12 show the photograph of the front and back of the RTKA210130DE0010BU board.

## 1.1 Setup and Configuration

1. Disable output of the socket board (switch SW1). Note the ON/OFF position on the board. Connect the ISLUSBEVAL1Z dongle to the RTKA210130DE0010BU socket board and plug in the USB connector to the host computer. Make sure there is a jumper between Pin 1 and 2 of VIN connector behind the board.
2. Use the appropriate cables to connect the DC input power supply to banana sockets 12V0 and TP1GND. Ensure that the polarity for the power leads is correct and the input voltage is within the operating range (4.75V to 15V) of the module.
3. Use test points TP1 (VIN) and TP2 (PGND) for accurately measuring the input voltage. Use test points TP3 (VOUT) and TP4 (PGND) for accurately measuring the output voltage.
4. Ensure the power supply at VIN is off. Open the latch on the socket and place the RAA210130 module in the socket. Location of Pin 1 of module is indicated in Figure 1. Close the latch of the socket to secure the module.

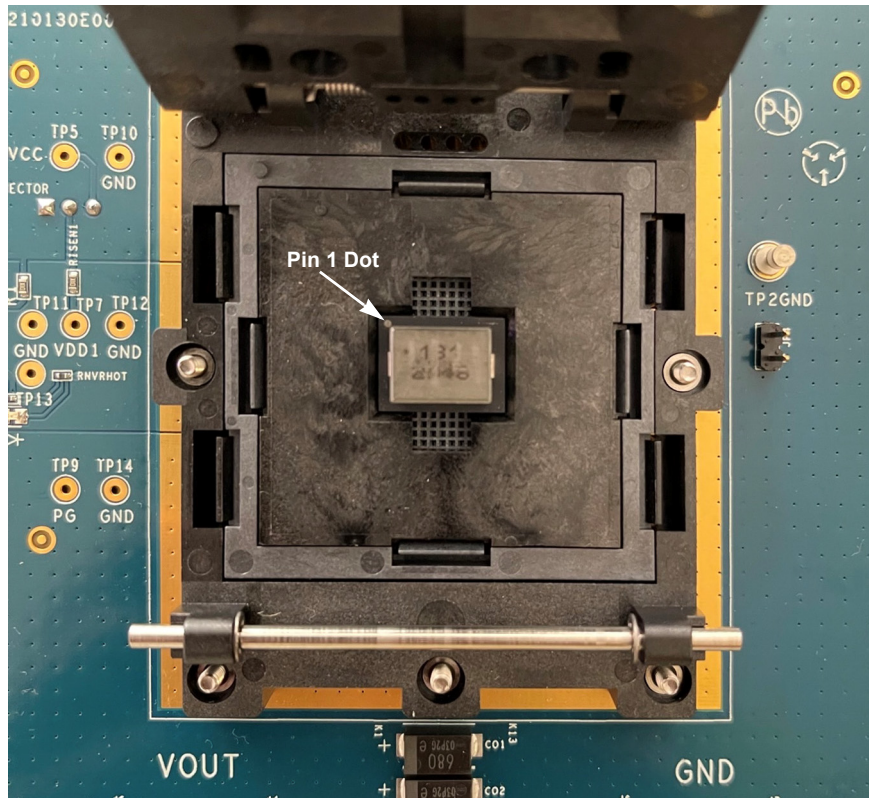

Figure 1. Photograph of Module in Socket Location of Pin 1 Indicated

5. Turn on the input power supply. Turn the switch SW1 to the ON position to enable the module. 2.75V should be observed on the output. Turn SW1 to the OFF position.
6. Launch Power Navigator on the computer.

- Observe module part number and I<sup>2</sup>C address(0x60) under the scanned devices as shown in Figure 2.

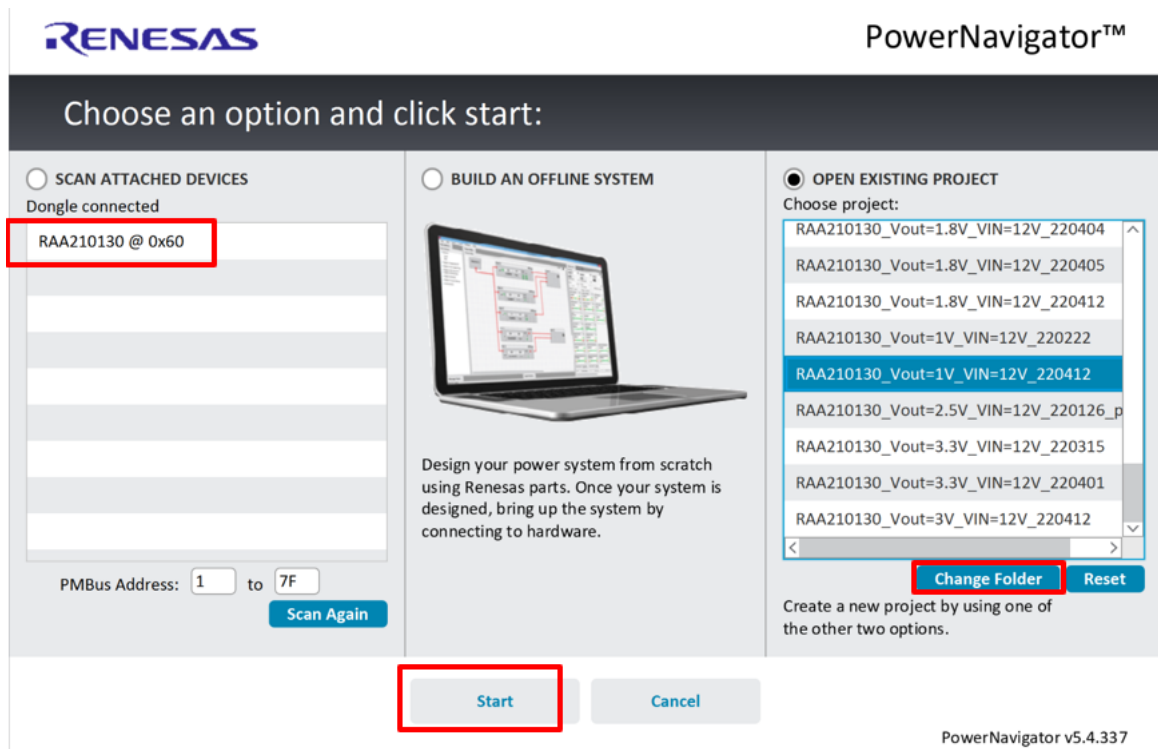

Figure 2. First screen of Power Navigator. Observe RAA210130 Module Part Number and Address

- Click on **Open Existing Project** as shown in Figure 2. Click on **Change Folder** if the configuration file is not in the current folder. A window called **Open Project** pops up as shown in Figure 3. Click on **Navigate** to navigate to the folder where the configuration file is stored. Select a project on the right-hand side to write to NVM. Select **Open**.

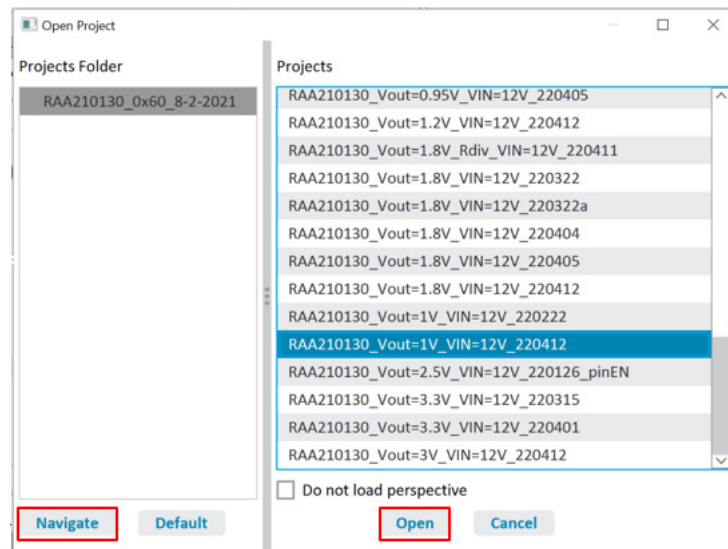

Figure 3. Open Project Window for Navigating to the Location where the Configuration File is Stored

9. The Power Navigator main page opens up. Double click **Rail 0** on the **Power Map** section as indicated in **Figure 4**. A configurations window opens up as shown in **Figure 5**.

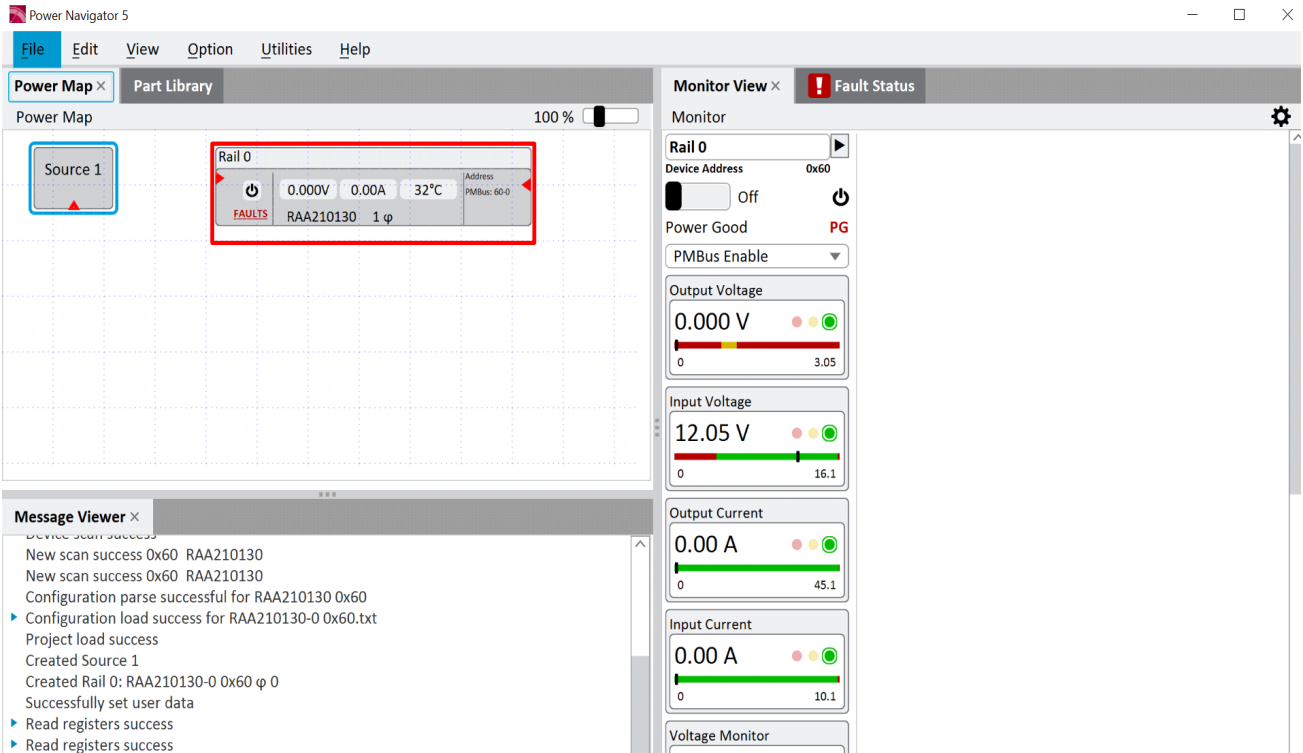

Figure 4. Power Navigator Main Page Double-Click on Rail 0 Indicated by the Red Box

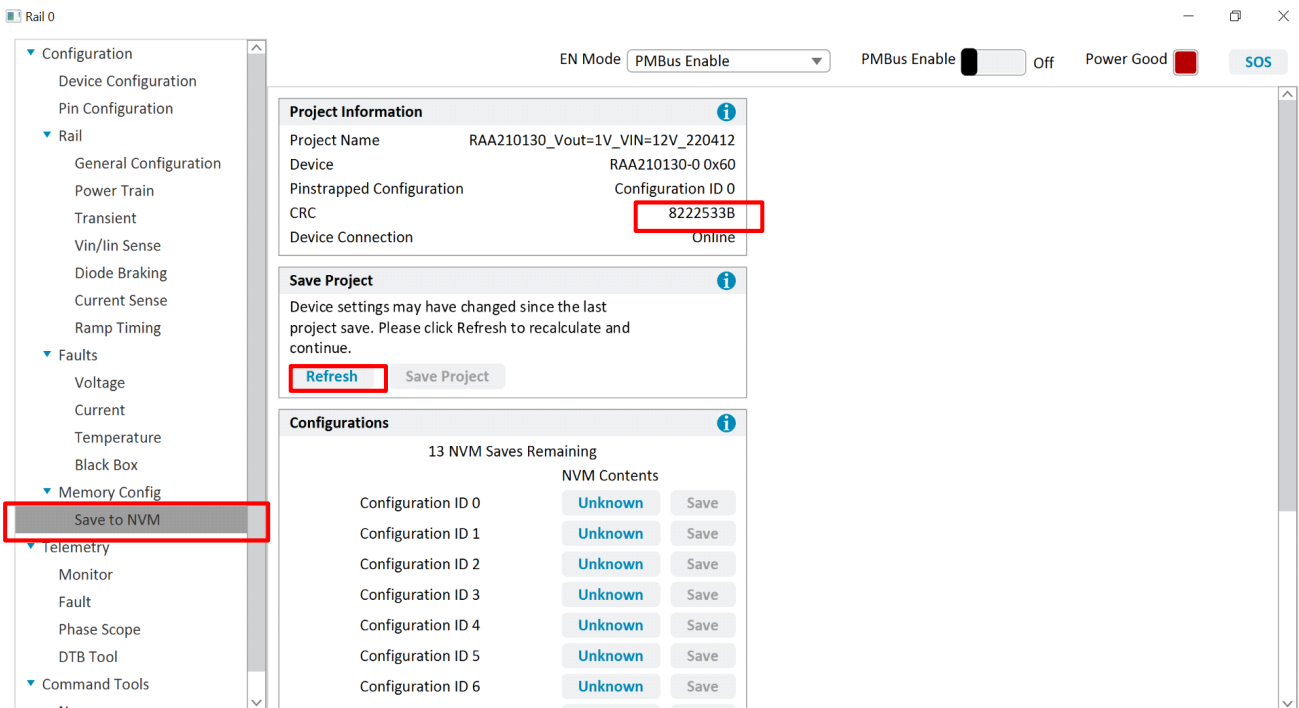

Figure 5. Configurations Page

- In the configurations window, under **Memory Config**, select **Save to NVM**. Check that the CRC number shown in Project information section is what is to be written. Under **Save Project** section, click on **Refresh**. Under the Configurations section the word Save on the right of every Configuration ID turns blue as shown in [Figure 6](#). The first line under Configurations section shows the number of NVM saves remaining. Select a configuration to save to and hit **Save**. In this example, Configuration ID 2 is selected. The user can select any of the 16 configuration IDs.

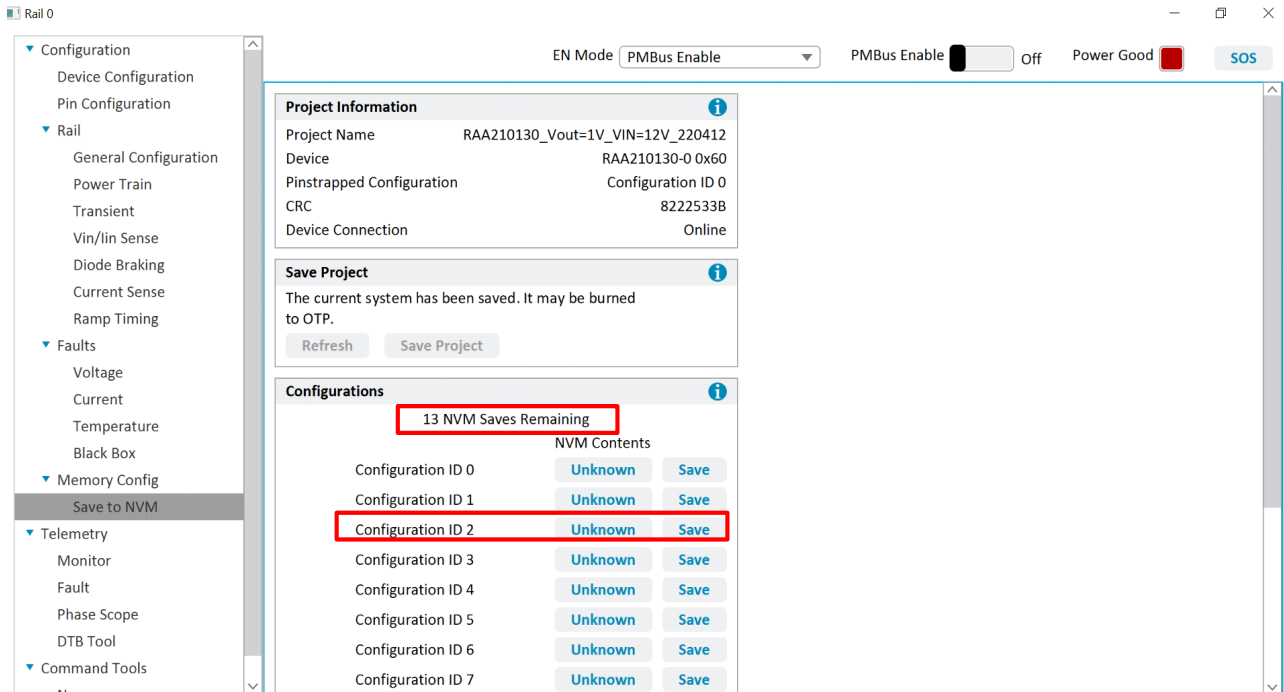

Figure 6. Save to NVM

- If the word **Save Project** in the middle section becomes blue, instead of the word **Save** on the right of every Configuration ID after hitting **Refresh**, as shown in [Figure 7](#), click on **Save Project** to save the changes to the project. A **Save Project** window pops up. Click on **Navigate** to select the folder to save the configuration file. Hit **Save** to save the configuration file.

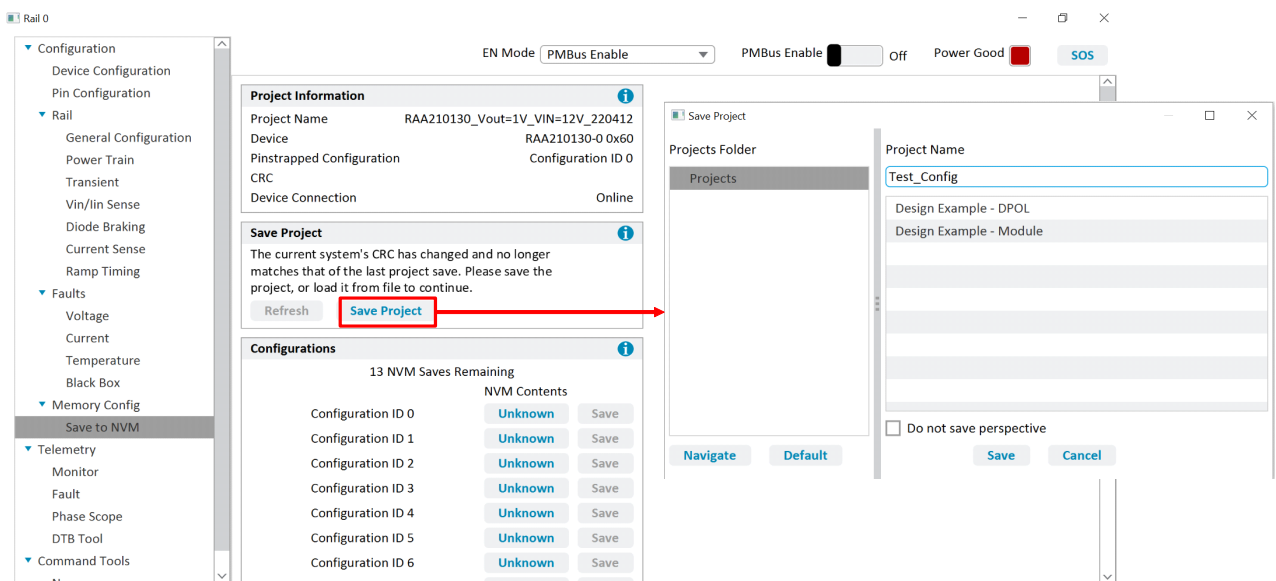
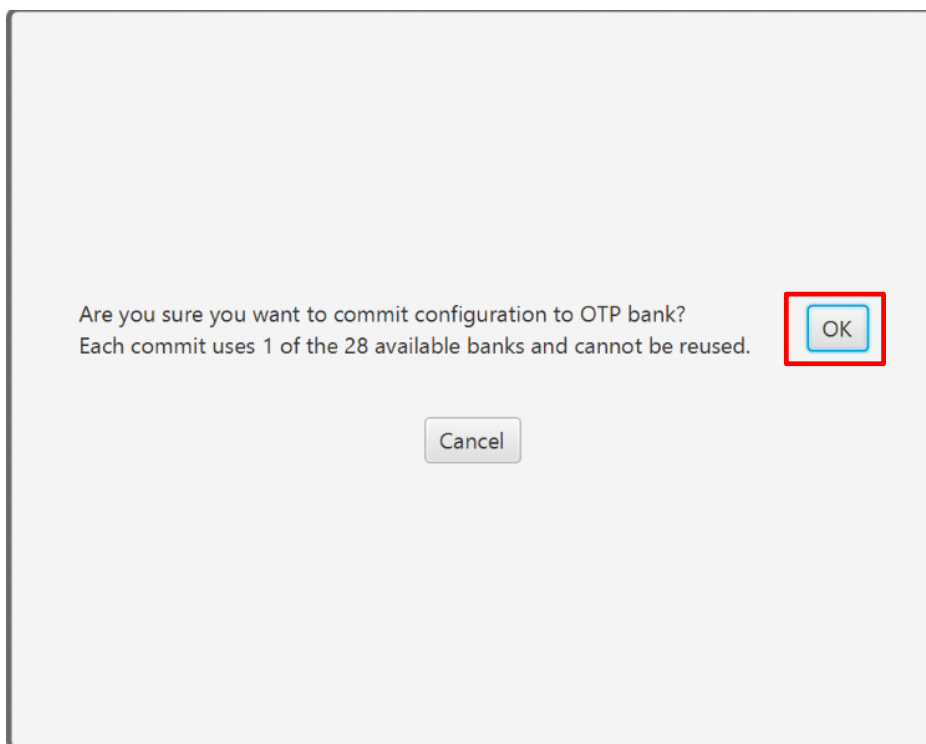

Figure 7. Saving Project before Writing to NVM



12. After the project is saved, the word **Save** on the right of every configuration ID turns blue, as shown in [Figure 6](#). Select a configuration to save to and hit **Save**.
13. A window pops up (see [Figure 8](#)) for the user to confirm the use of 1 of the 28 available OTP banks to write to the NVM. Click **OK**.



**Figure 8. Confirmation to Use 1 of the 28 Available OTP Banks to Write to NVM**

14. When saving to the OTP is successful, another window pops up (see [Figure 9](#)). Click **Close Program** to close the Power Navigator. Power cycle the board.

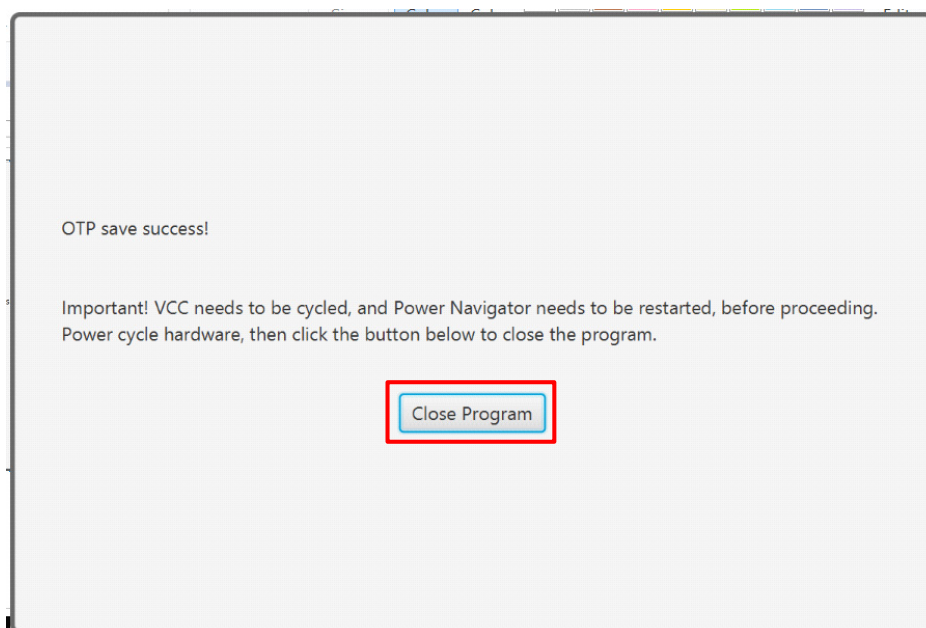

**Figure 9. Window Showing OTP Save Success**

15. Open Power Navigator. Go to **Memory Config** -> **Save to NVM**. Check that the CRC number is written correctly to the selected configuration ID as shown in **Figure 10**.

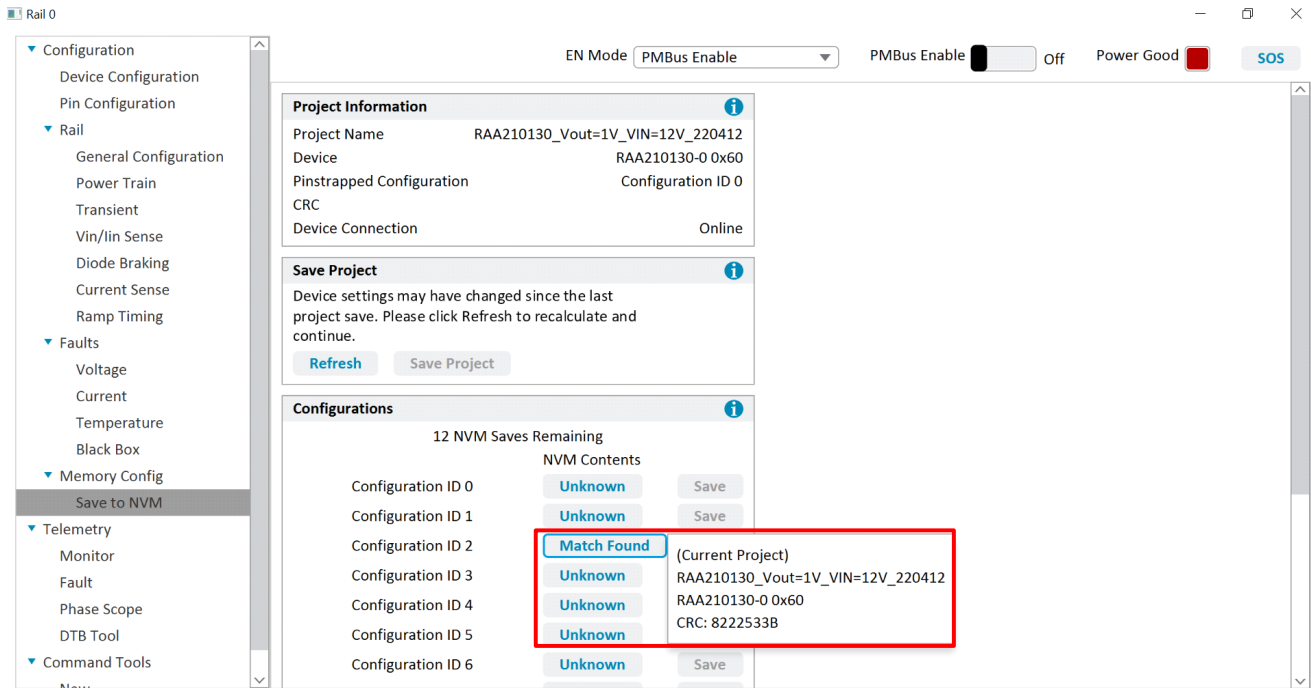

Figure 10. Verifying CRC Number Written to Selected Configuration ID

## 2. Board Design

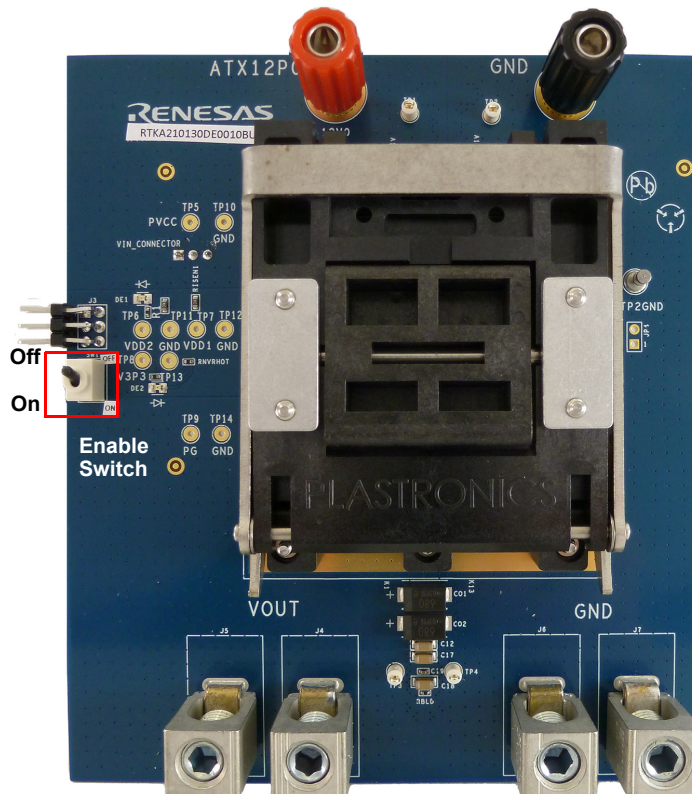

Figure 11. Top of Board



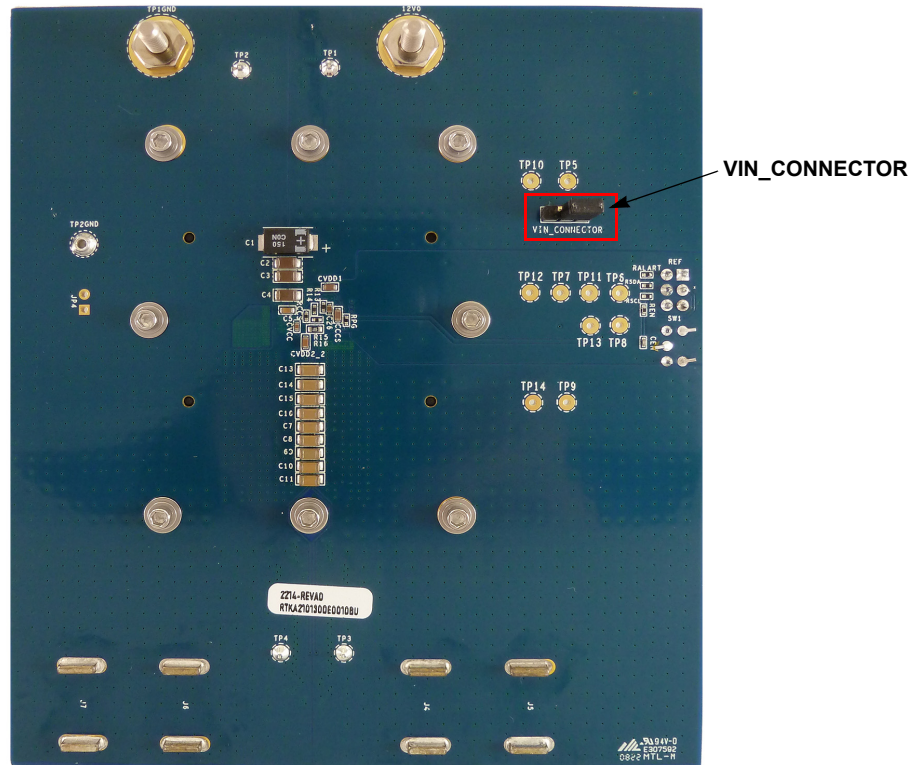

Figure 12. Bottom of Board

## 2.1 Schematic Diagram

The RTKA210130DE0010BU socket board is a 4.5inx5.0in six-layer FR-4 board with 2oz. copper on all the layers. The board schematic is shown in Figure 13.

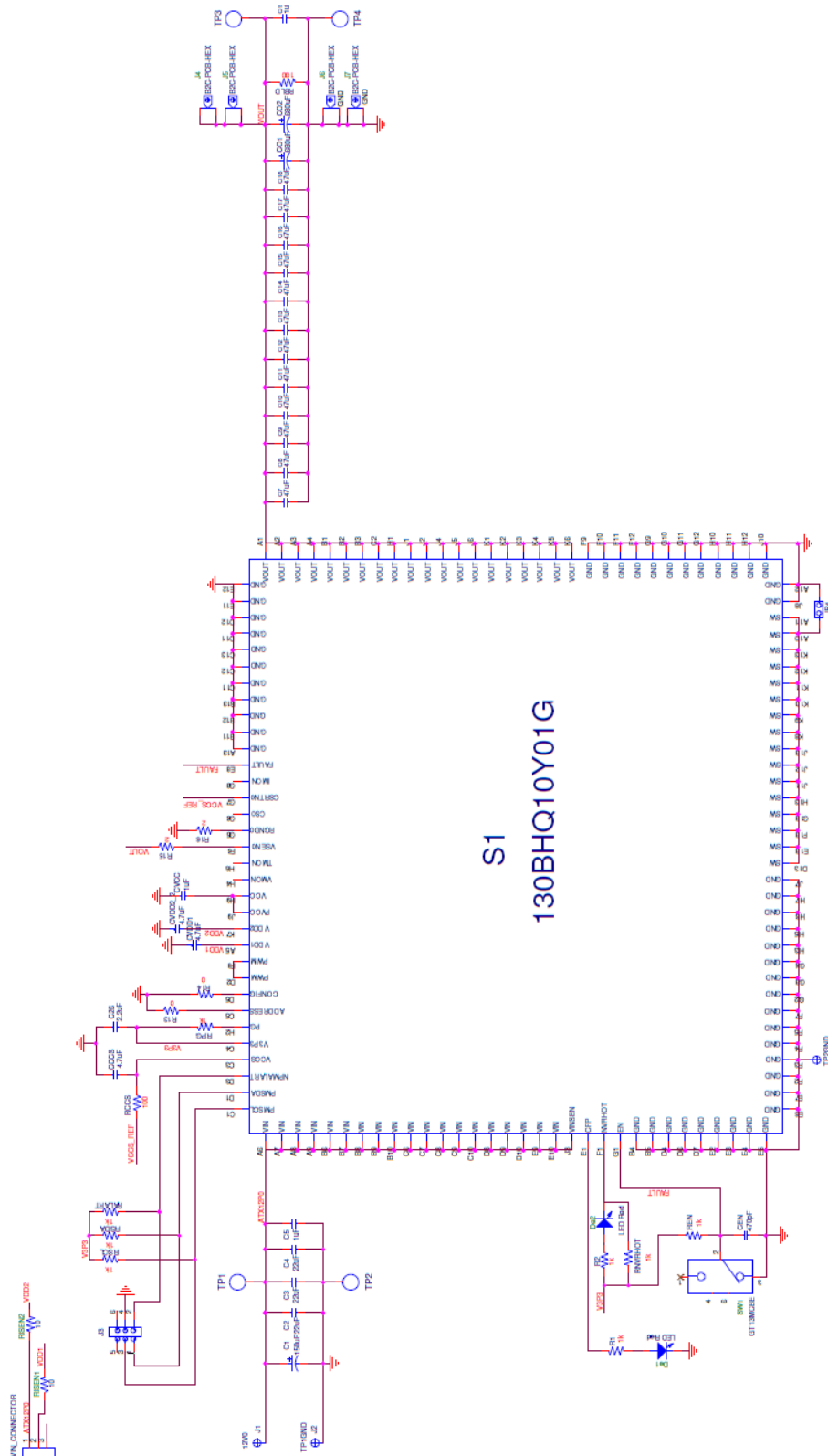

Figure 13. RTKA210130DE0010BU Schematic

## 2.2 Bill of Materials

The following table shows the bill of materials for RTKA210130DE0010BU socket board.

Qty	Reference Designator	Description	Manufacturer	Manufacturer Part Number
1	S1	CONN-DEVICE SOCKET, 13x10mm, 130P, H-PINS, 1.0mmPITCH, ROHS	Plastronics Socket CO.	130BHQ10Y01G
1	C1	CAP-TANT.POSCAP, SMD, 7.3x4.3mm.150μF, 16V, 20%, ROHS	Panasonic	16TDC150MYF
3	C2, C3, C4	CAP, SMD, 1206, 22μF, 25V, 20%, X6S, ROHS	Murata	GRM31CC81E226ME11L
1	C5	CAP-AEC-Q200, SMD, 0603, 1μF, 25V, 10%, X7R, ROHS	Murata	GCM188R71E105KA64D
1	CEN	CAP, SMD, 0402, 470pF, 50V, 5%, C0G/NP0, ROHS	Murata	GRM1555C1H471JA01J
2	C19, CVCC	CAP, SMD, 0402, 1μF, 10V, 10%, X7S, ROHS	Murata	GRM155C71A105KE11D
1	C26	CAP, SMD, 0402, 2.2μF, 25V, 20%, X6S, ROHS	Murata	GRM155C81E225ME11D
3	CVDD1, CVDD2_2, CCCS	CAP-AEC-Q200, SMD, 0603, 4.7μF, 25V, 20%, X6S, ROHS	Murata	GRM188C81E475ME11D
12	C7, C8, C9, C10, C11, C12, C13, C14, C15, C16, C17, C18	CAP-AEC-Q200, SMD, 1206, 47μF, 6.3V, 20%, X6S, ROHS	Murata	GRT31CC80J476ME13L
2	CO1, CO2	CAP-ALUM.POLY, SMD, 7.3x4.3mm, 680uF, 2.5V, 20%, 3mohm, ROHS	PANASONIC	EEF-GY0E681R
2	RCCS, RBLD	RES, SMD, 0402, 100Ω, 1/16W, 1%, TF, ROHS	Yageo	RC0402FR-07100RL
1	R15	RES, SMD, 0402, 2Ω, 1/16W, 1%, TF, ROHS	Yageo	RC0402FR-072RL
1	R16	RES, SMD, 0603, 2Ω, 1/16W, 1%, TF, ROHS	Yageo	RC0603FR-072RL
2	R13, R14	RES-AEC-Q200, SMD, 0402, 0ohm, 1/16W, TF, ROHS	STACKPOLE	RMCF0402ZT0R00
8	R1, R2, RALART, REN, RNVRHOT, RPG, RSCL, RSDA	RES, SMD, 0402, 1K, 1/16W, 1%, TF, ROHS	Yageo	RC0402FR-071KL
2	RISEN1, RISEN2	RES, SMD, 0603, 10Ω, 1/10W, 1%, TF, ROHS	Yageo	RC0603FR-0710RL
1	12V0	CONN-GEN, BIND.POST, INSUL-RED, THMBNUT-GND	Johnson Components	111-0702-001
1	TP1GND	CONN-GEN, BIND.POST, INSUL-BLK, THMBNUT-GND	Johnson Components	111-0703-001
4	TP1, TP2, TP3, TP4,	CONN-MINI TEST POINT, VERTICAL, WHITE, ROHS	Keystone	5002
1	TP2GND	CONN-DBL TURRET, TH, 0.218x0.109 PCB MNT, TIN/BRASS, ROHS	Keystone	1502-2

Qty	Reference Designator	Description	Manufacturer	Manufacturer Part Number
1	VIN_CONNECTOR	CONN-HEADER, 1x3, BREAKAWY 1x36, 2.54mm, ROHS	BERG/FCI	68000-236HLF
1	VIN_CONNECTOR	CONN-HEADER, 1x3, BREAKAWY 1x36, 2.54mm, ROHS	BERG/FCI	68000-236HLF
1	VIN_CONNECTOR Pins 1-2	CONN-JUMPER, SHUNT, 2P, 2.54mmPITCH, BLK, 6mm, OPEN, ROHS	SULLINS	SPC02SYAN
1	SW1	SWITCH-TOGGLE, THRU-HOLE, 5PIN, SPDT, 3POS, ON-OFF-ON, ROHS	C&K Components	GT13MCBE
4	J4, J5, J6, J7	HDWARE-WIRE LUG, TH, 11.8x10.3mm, HEX SCREW, 2-14AWG, ROHS	International Hydraulics Inc	B2C-PCB-HEX
2	DE1, DE2	LED, SMD, 0603, RED CLEAR, 2V, 20mA, 631nm, 54mcd, ROHS	LITEON/VISHAY	LTST-C191KRKT-T
1	J3	CONN, HEADER, TH, 2x3, R/A, 2.54mmPITCH, TIN, ROHS	BERG/FCI	68021-406HLF
4	Four corners	BUMPS, 0.44inWx0.20inH, CYLINDRICAL DOME, BLK, ROHS	3M	SJ-5003-BLACK
0	JP4	DO NOT POPULATE OR PURCHASE		
0	TP5-TP14	DO NOT POPULATE OR PURCHASE		

### 2.3 Board Layout

See Figure 14 through Figure 21 for board layout for each layer.

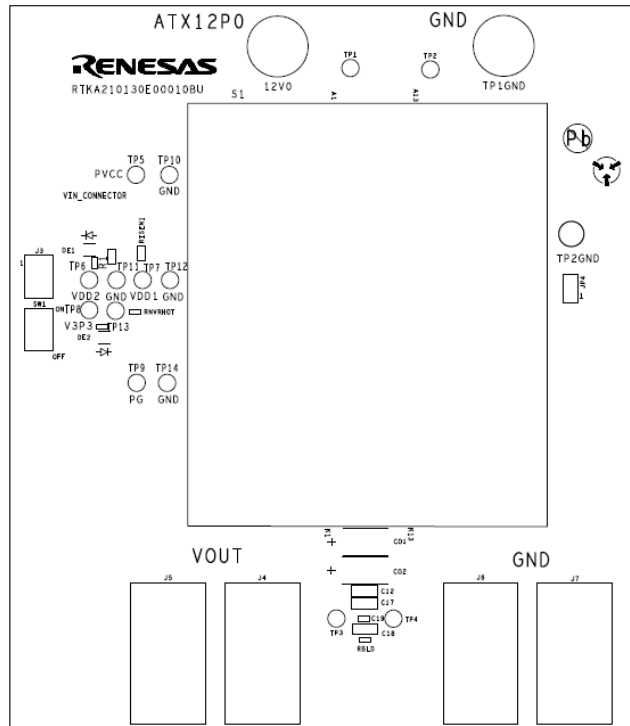

Figure 14. Silkscreen Top

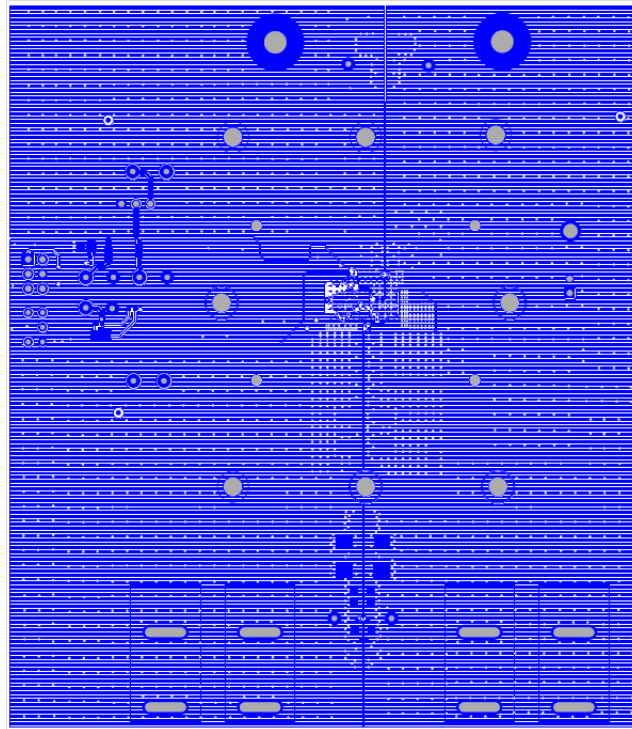

Figure 15. Top Layer Component Side

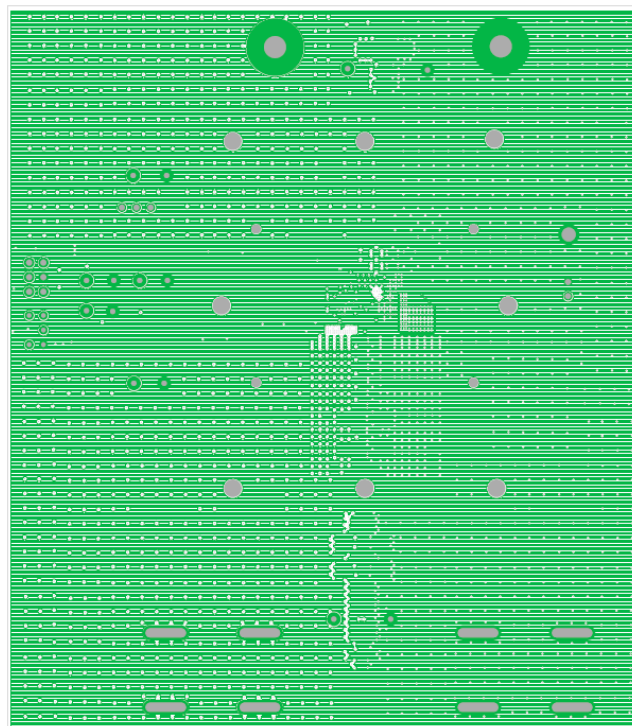

Figure 16. Inner Layer 2

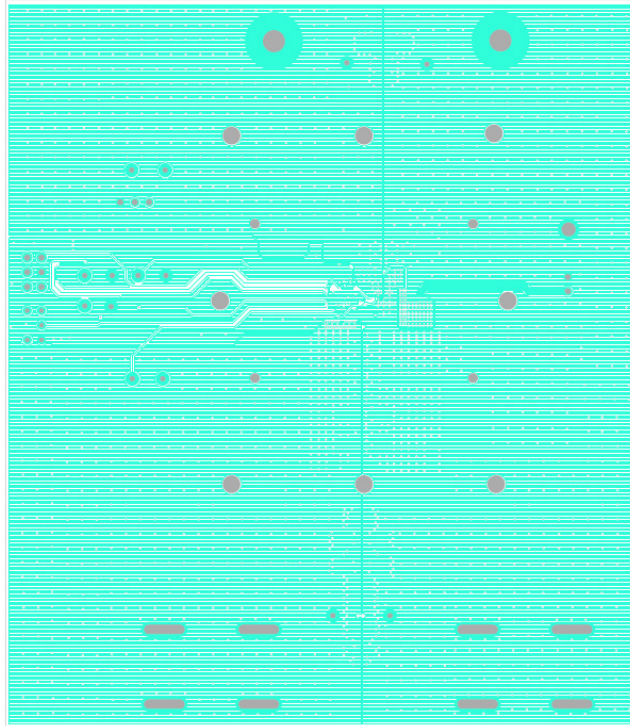

Figure 17. Inner Layer 3

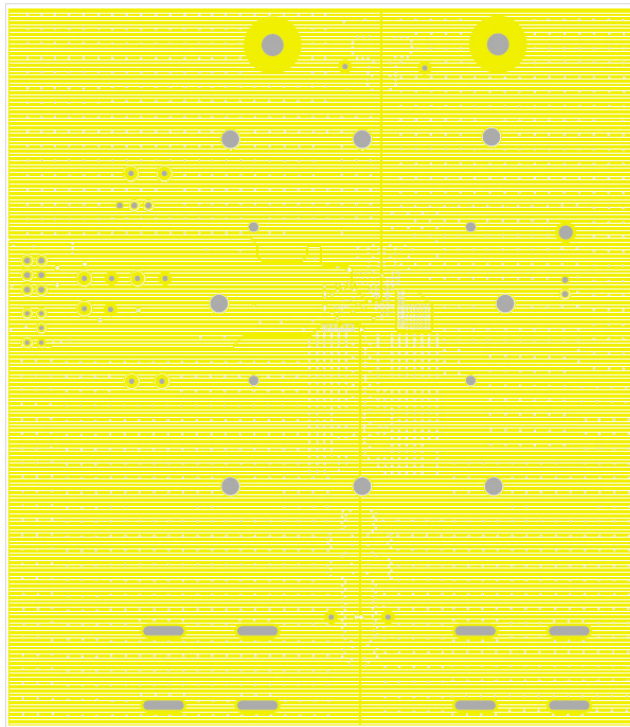

Figure 18. Inner Layer 4



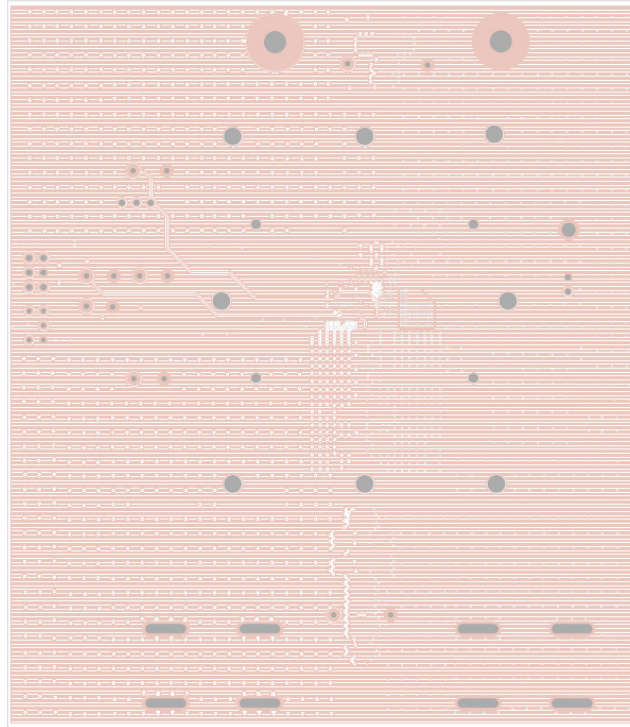

Figure 19. Inner Layer 5

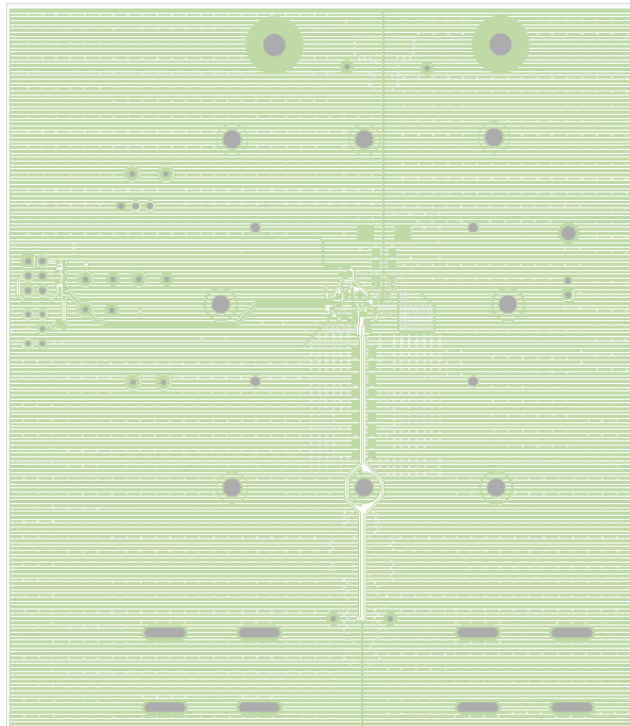

Figure 20. Bottom Layer

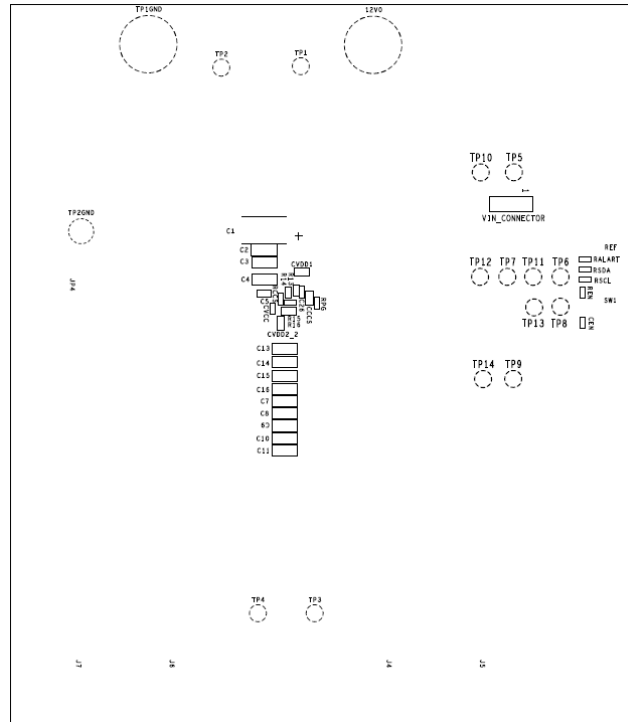

Figure 21. Silkscreen Bottom

### 3. Ordering Information

Part Number	Description
RTKA210130DE0010BU	RAA210130 Single Socket Board

### 4. Revision History

Revision	Date	Description
1.00	May 28, 2022	Initial release

## IMPORTANT NOTICE AND DISCLAIMER

RENESAS ELECTRONICS CORPORATION AND ITS SUBSIDIARIES (“RENESAS”) PROVIDES TECHNICAL SPECIFICATIONS AND RELIABILITY DATA (INCLUDING DATASHEETS), DESIGN RESOURCES (INCLUDING REFERENCE DESIGNS), APPLICATION OR OTHER DESIGN ADVICE, WEB TOOLS, SAFETY INFORMATION, AND OTHER RESOURCES “AS IS” AND WITH ALL FAULTS, AND DISCLAIMS ALL WARRANTIES, EXPRESS OR IMPLIED, INCLUDING, WITHOUT LIMITATION, ANY IMPLIED WARRANTIES OF MERCHANTABILITY, FITNESS FOR A PARTICULAR PURPOSE, OR NON-INFRINGEMENT OF THIRD PARTY INTELLECTUAL PROPERTY RIGHTS.

These resources are intended for developers skilled in the art designing with Renesas products. You are solely responsible for (1) selecting the appropriate products for your application, (2) designing, validating, and testing your application, and (3) ensuring your application meets applicable standards, and any other safety, security, or other requirements. These resources are subject to change without notice. Renesas grants you permission to use these resources only for development of an application that uses Renesas products. Other reproduction or use of these resources is strictly prohibited. No license is granted to any other Renesas intellectual property or to any third party intellectual property. Renesas disclaims responsibility for, and you will fully indemnify Renesas and its representatives against, any claims, damages, costs, losses, or liabilities arising out of your use of these resources. Renesas' products are provided only subject to Renesas' Terms and Conditions of Sale or other applicable terms agreed to in writing. No use of any Renesas resources expands or otherwise alters any applicable warranties or warranty disclaimers for these products.

(Rev.1.0 Mar 2020)

### Corporate Headquarters

TOYOSU FORESIA, 3-2-24 Toyosu,  
Koto-ku, Tokyo 135-0061, Japan  
[www.renesas.com](http://www.renesas.com)

### Contact Information

For further information on a product, technology, the most up-to-date version of a document, or your nearest sales office, please visit:  
[www.renesas.com/contact/](http://www.renesas.com/contact/)

### Trademarks

Renesas and the Renesas logo are trademarks of Renesas Electronics Corporation. All trademarks and registered trademarks are the property of their respective owners.

## X-ON Electronics

Largest Supplier of Electrical and Electronic Components

*Click to view similar products for [Power Management IC Development Tools](#) category:*

*Click to view products by [Renesas](#) manufacturer:*

Other Similar products are found below :

[EVB-EP5348UI](#) [BQ25010EVM](#) [ISL80019AEVAL1Z](#) [ISLUSBI2CKIT1Z](#) [ISL8002AEVAL1Z](#) [ISL91108IIA-EVZ](#) [MAX8556EVKIT](#)  
[MAX15005AEVKIT+](#) [ISL28022EVKIT1Z](#) [STEVAL-ISA008V1](#) [DRI0043](#) [KITPF8100FRDMEVM](#) [EVB-EN6337QA](#)  
[SAMPLEBOXILD8150TOBO1](#) [MAX18066EVKIT#](#) [AP62300WU-EVM](#) [KITA2GTC387MOTORCTRTOBO1](#) [AEK-MOT-TK200G1](#)  
[EVLONE65W](#) [STEVAL-ILH006V1](#) [STEVAL-IPE008V2](#) [STEVAL-IPP001V2](#) [STEVAL-ISA013V1](#) [STEVAL-ISA067V1](#) [STEVAL-](#)  
[ISQ002V1](#) [TPS2306EVM-001](#) [TPS2330EVM-185](#) [TPS40001EVM-001](#) [SECO-HVDCDC1362-15W-GEVB](#) [BTS7030-2EPA](#)  
[LT8638SJV#WPBF](#) [LTC3308AIV#WTRPBF](#) [TLT807B0EPV](#) [BTS71033-6ESA](#) [EV13N91A](#) [EASYPIC V8 OVER USB-C](#) [EV55W64A](#)  
[CLICKER 4 FOR STM32F4](#) [EASYMX PRO V7A FOR STM32](#) [CLICKER 4 FOR PIC18F](#) [Si8285\\_86v2-KIT](#) [PAC52700EVK1](#) [NCP-](#)  
[NCV51752D2PAK3LGEVB](#) [ISL81807EVAL1Z](#) [AP33772S-EVB](#) [EVALM7HVIGBTFCINV4TOBO1](#) [903-0300-000](#) [902-0173-000](#) [903-](#)  
[0301-000](#) [ROA1286023/1](#)