

RTKA211405DE0000BU

The RAA211405 is an integrated 5V, 300mA buck regulator with an ultra low quiescent current (I_Q) of 4 μ A. It supports a wide input voltage range from 7V to 40V. The RAA211405 is offered in a TSOT23-5 (2.9mm \times 1.63mm) package. The RTKA211405DE0000BU evaluation board provides a quick and comprehensive platform for evaluating the performance features of the RAA211405 buck regulator.

The RTKA211405DE0000BU evaluation board operates from a supply voltage of 7V to 40V_{DC} with the capability of delivering a continuous load up to 300mA at 5V output voltage.

Specifications

This board is configured and optimized for the following operating conditions:

- Input voltage range: 7V to 40V
- Output voltage: 5V
- Up to 300mA output current capability
- Inductor current limit of 750mA (typical) peak
- Operating temperature range: -40°C to +125°C

Features

- 7V to 40V input supply range
- Up to 300mA output current
- $I_Q = 4\mu A$ at 40V, at no load conditions, switching
- $I_Q = 2.5\mu A$ at 40V at no load and no switching conditions
- Minimum on-time of 75ns
- Fixed 5V V_{OUT}
- Variable frequency operation, frequency programmed by external inductor (4.7 μ H to 15 μ H)
- Pre-bias start-up / Monotonic / smooth start-up
- Total of four external components
- Protections: Overcurrent (OC) Limit, input Undervoltage Lockout (UVLO), Over-Temperature Protection (OTP), output Overvoltage Protection (OVP)
- Accurate EN threshold

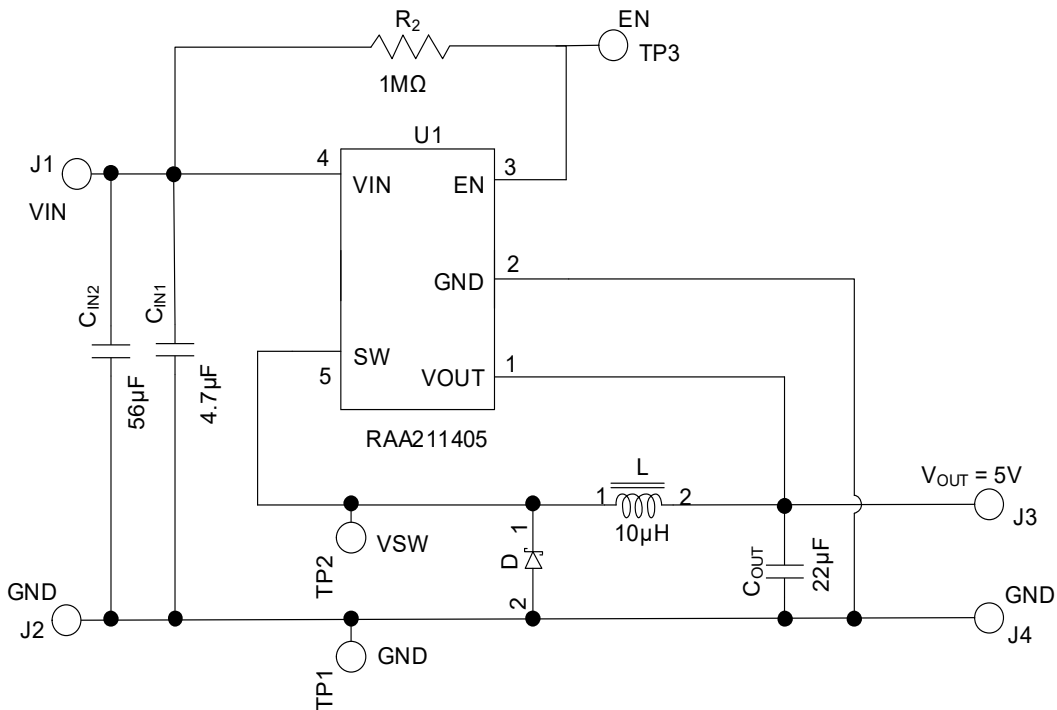

Figure 1. RTKA211405DE0000BU Block Diagram

Contents

1. Functional Description	3
1.1 Operational Characteristics	3
1.2 Connectors, Test Points, Selection Switches, and Jumper Descriptions	3
1.3 Recommended Equipment	3
1.4 Quick Start Guide	3
1.5 Enable	4
1.6 Soft-Start	4
1.7 Switching Frequency	4
2. Board Design	5
2.1 Layout Guidelines	5
2.2 Schematic Diagram	5
2.3 Bill of Materials	6
2.4 Board Layout	6
3. Typical Performance Graphs	8
4. Ordering Information	10
5. Revision History	10

1. Functional Description

The RTKA211405DE0000BU evaluation board provides a comprehensive and versatile platform for you to assess functionality and prototype an application with the integrated 5V, 300mA buck regulator RAA211405. The board has options for evaluating most features of the RAA211405 and includes test points that facilitate probing.

1.1 Operational Characteristics

The RTKA211405DE0000BU evaluation board evaluates the RAA211405 with VIN from 7V to 40V and a continuous load of 300mA. Renesas recommends operating the board within the specifications for the proper functioning of the evaluation board.

You can connect EN to VIN through a resistor, or you can connect EN to external logic voltage for enable and disable.

1.2 Connectors, Test Points, Selection Switches, and Jumper Descriptions

The RTKA211405DE0000BU evaluation board includes I/O connectors, test points, selection switches, and jumpers to provide a comprehensive and versatile platform for evaluating the RAA211405 (see [Table 1](#)).

Table 1. Connectors, Test Points, and Jumper Descriptions

Reference Designator	Description
J1	Input voltage positive connection
J2	Input voltage return connection
J3	Output voltage positive connection
J4	Output voltage return connection
TP1	GND test point
TP2	VSW
TP3	ENABLE test point

1.3 Recommended Equipment

- A power supply that can deliver 40V or higher with at least 350mA source current capability.
- Electronic load capable of sinking at least 350mA current.
- 4-channel oscilloscope with voltage and current probes.

1.4 Quick Start Guide

Complete the following steps to configure and power up the board properly.

1. Set the power supply voltage to 24V and turn off the power supply. Connect the positive output of the power supply to J1 (VIN) and the negative output to J2 (GND).
2. Connect an electronic load to J3 (VOUT) for the positive connection and J4 (GND) for the negative connection.
3. Place scope probes to VOUT (J3), VSW (TP2), and/or other test points of interest.
4. Set the load current to 0.1A and turn on the power supply. The output voltage should be in regulation with nominal 5V output.
5. Slowly increase the load up to 300mA. The output voltage should remain in regulation with nominal 5V output.
6. Slowly sweep VIN from 7V to 40V. The output voltage should remain in regulation with nominal 5V output.
7. Decrease the input voltage to 0V to shut down the regulator.

1.5 Enable

EN is connected to VIN through R2. EN can be driven by an external source or by removing R2. Do not leave this pin floating.

1.6 Soft-Start

RAA211405 is naturally current limited and automatically provides a smoothly rising VOUT voltage at power up. Because the total output of the device is limited, a startup with a heavy load generates a longer VOUT ramp; a startup with no load generates a faster ramp.

The approximate soft-start time^[1] based on the RTKA211405DE0000BU with 24V input at no load is 190µs and 360µs at full load.

1.7 Switching Frequency

The regulator is a variable frequency converter, and the switching frequency varies proportionally to the load. The maximum switching frequency is dependent on inductance and input voltage.

Figure 2 and Figure 3 show the bench data for the evaluation board. Use Equation 1 to approximate the switching frequency.

$$(EQ. 1) \quad \text{SwitchingFrequency} = \frac{2 \times I_{load}}{L \times |peak| \times |peak| \times \left(\frac{1}{V_{IN} - V_{OUT}} + \frac{1}{V_{OUT}} \right) \times \text{Efficiency}}$$

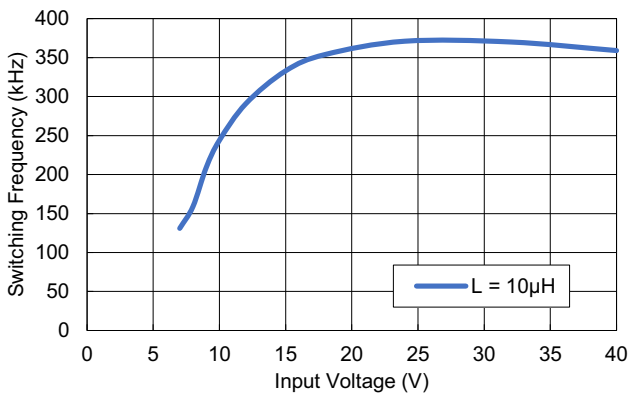

Figure 2. Switching Frequency (Full Load, 300mA) vs Input Voltage

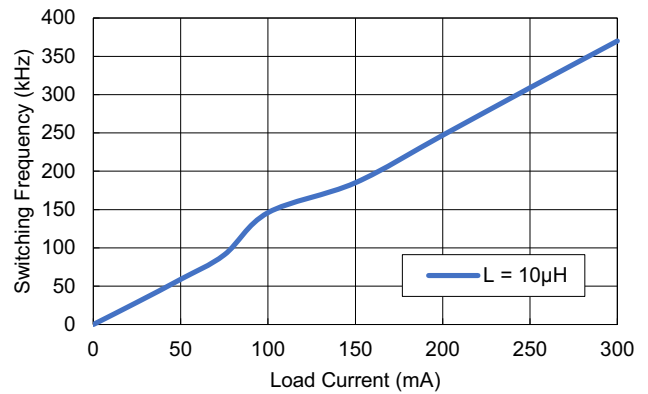

Figure 3. Switching Frequency (VIN 24V) vs Load Current

1. Test conditions: VIN = 24V, COUT = 22µF (PN:GRM187R61A226ME15D), CIN1 = 4.7µF (PN:CL21A475KBQNNNE), CIN2 = 56µF (PN:63SXV56M), L = 10µH (PN:74438335100), Power supply: Chroma-632012P-100-50, Load: Resistive Load equivalent to full load at nominal VOUT. Measured from 0 and 100% of nominal VOUT.

2. Board Design

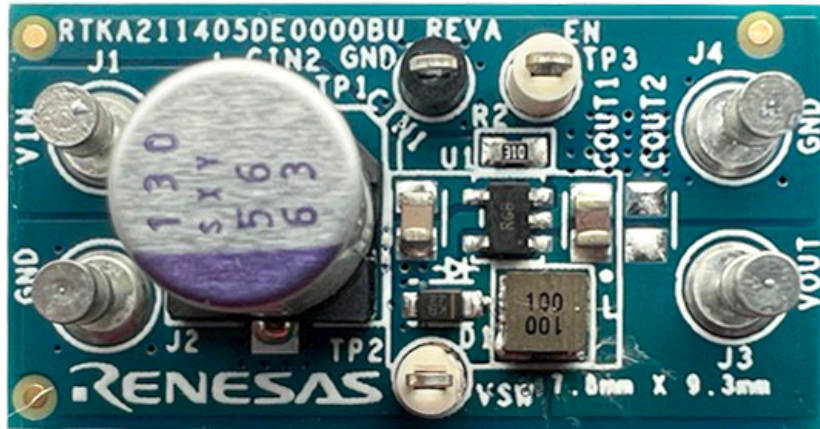

Figure 4. RTKA211405DE0000BU Evaluation Board (Top)

2.1 Layout Guidelines

The printed circuit board (PCB) layout is critical for the proper operation of RAA211405. The following guidelines are recommended to achieve optimal performance.

- Use a multilayer PCB structure to achieve optimized performance. The evaluation board RTKA211405DE0000BU uses a 2-layer PCB with 1oz copper and the bottom layer as ground.
- Place the input capacitor as close as possible to the IC. The input capacitor is the most important component for any step-down converter and should be the first component to be placed in the layout.
- The copper area of the SW NODE should not be more than needed. Place the inductor close to the regulator.
- Place an output capacitor close to the inductor.
- Place and route the power component to keep the power loop area as minimum and short as possible.
- Keep all the power components on the same side of the PCB.
- Include thermal vias as necessary to improve heat dissipation.

2.2 Schematic Diagram

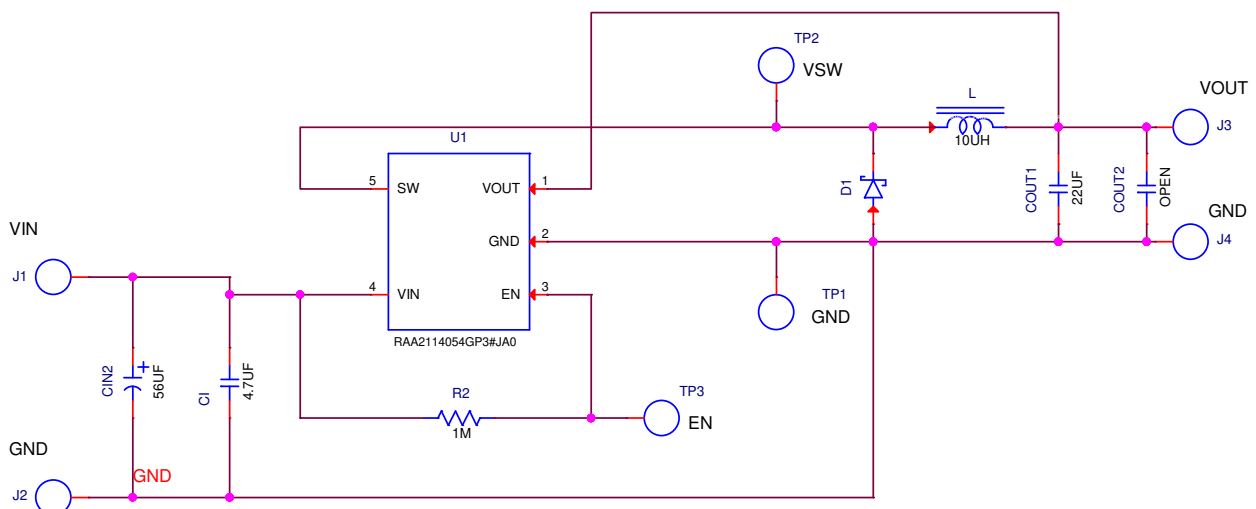

Figure 5. RTKA211405DE0000BU Schematic

2.3 Bill of Materials

Qty	Reference Designator	Description	Manufacturer	Manufacturer Part Number
1	L	COIL-PWR Inductor, SMD, 3mm, 10μH, 20%, 2A, 446mΩ DCR, WW, ROHS	Würth	74438335100
1	CIN1	Multilayer Cap, SMD, 0805, 4.7μF, 10%, 50V	Samsung	CL21A475KBQNNNE
1	CIN2	CAP ALUM POLY 56UF 20% 63V SMD	Panasonic	63SXV56M
1	R2	Thick Film Chip Resistor, SMD, 0603, 1M, 1%, 1/10W	Generic	Various
1	D1	1A 60V Low Vf Schottky Barrier Rectifier, SOD323F	Panjit	MBR1060HEWS_R1_00001
1	U1	5V, 300mA DC-DC Buck Regulator with low quiescent current, SOT23-5	Renesas	RAA2114054GP3#JA0
1	COUT1	Multilayer Cap, SMD, 0805, 22μF, 20%, 16V	Generic	Various
0	COUT2	Multilayer Cap, SMD, 0805, 22μF, 20%, 16V	DNP	DNP
4	J1, J2, J3, J4	Brass Test Point Turret, 0.150 Pad, 0.100 Thole, PCB Depth <0.078 in	Keystone	1502-1
1	GND	Miniature Black Test Point, 0.100 Pad, 0.040 Thole	Keystone	5001
2	VSW, EN	Miniature White Test Point, 0.100 Pad, 0.040 Thole	Keystone	5002

2.4 Board Layout

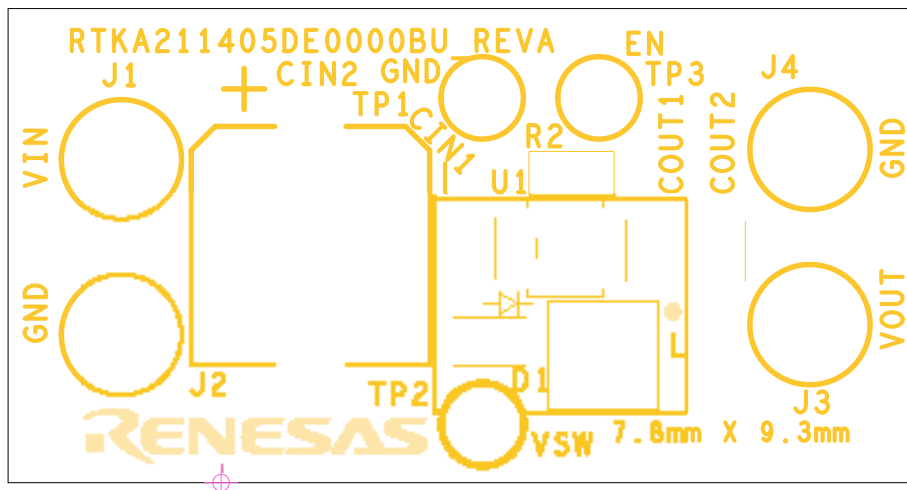

Figure 6. Silkscreen Top

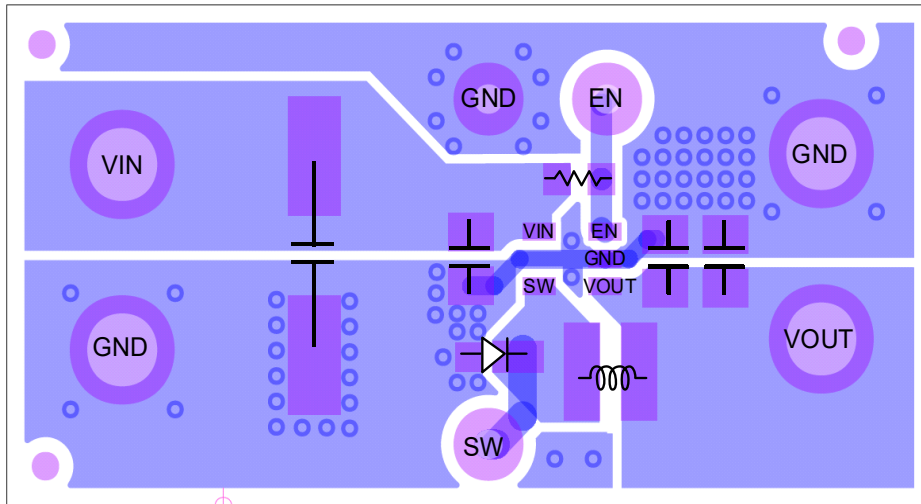

Figure 7. Top Layer

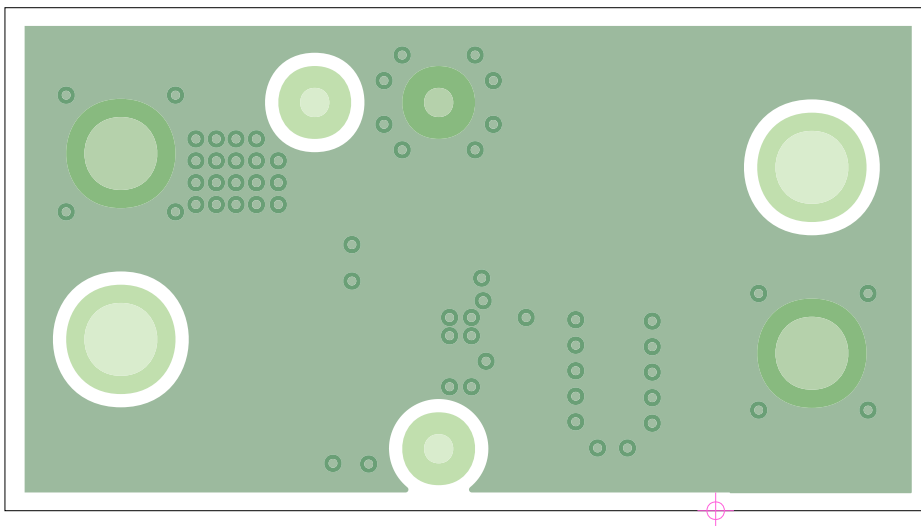

Figure 8. Bottom Layer

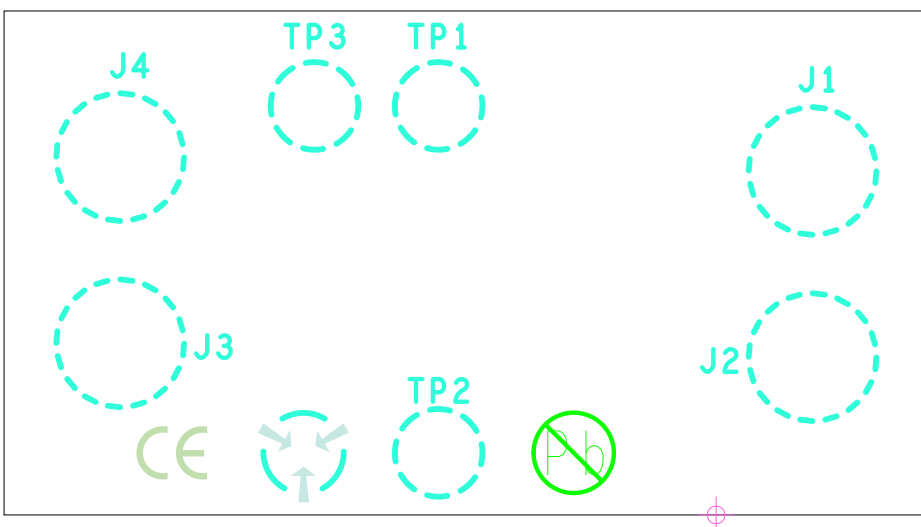

Figure 9. Silkscreen Bottom

3. Typical Performance Graphs

$V_{IN} = 24V$, $V_{OUT} = 3.3V$, $I_{OUT} = 300mA$, $L = 10\mu H$, $C_{OUT} = 22\mu F$, $R_{en} = 1M\Omega$, $T_A = +25^\circ C$, internal compensation, internal soft-start unless otherwise stated.

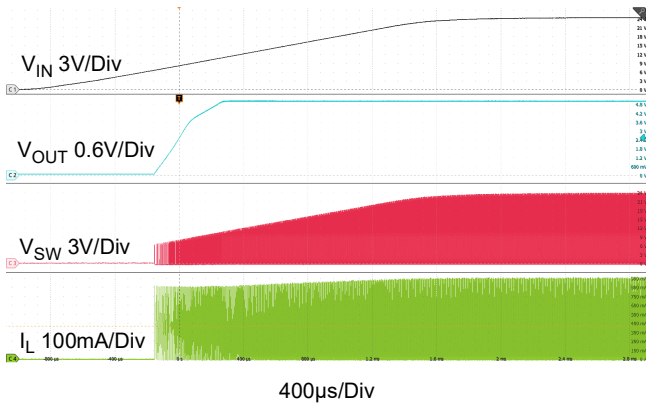

Figure 10. Startup through VIN

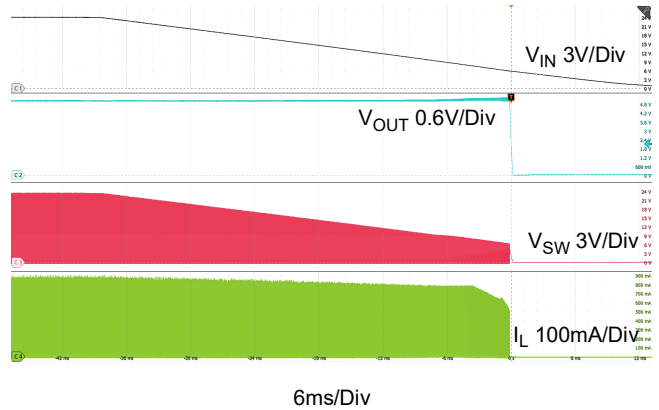

Figure 11. Shutdown through VIN

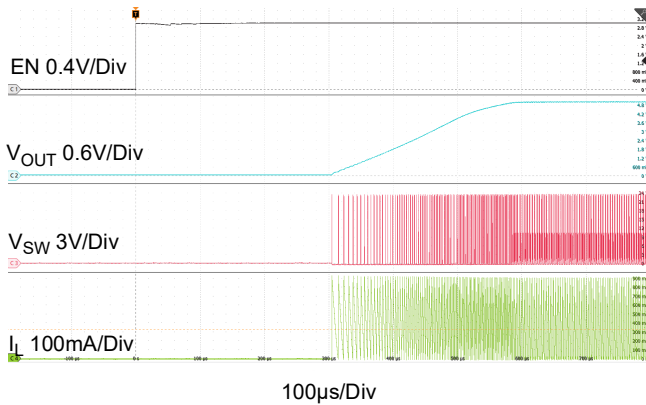

Figure 12. Startup through EN

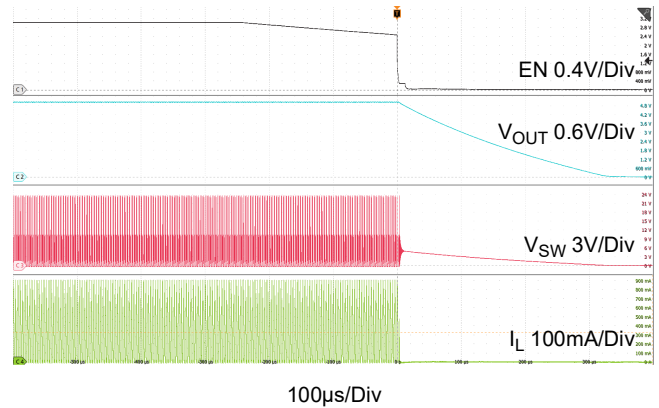

Figure 13. Shutdown through EN

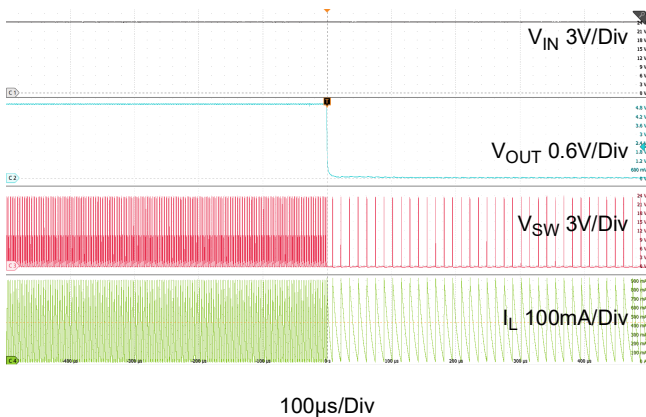

Figure 14. Short-Circuit

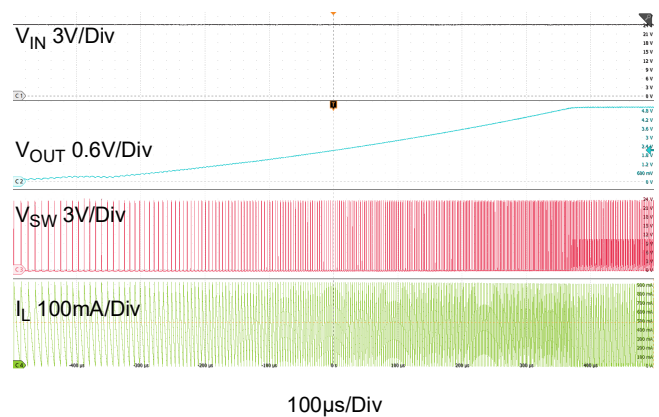

Figure 15. Recovery from Short-Circuit

$V_{IN} = 24V$, $V_{OUT} = 3.3V$, $I_{OUT} = 300mA$, $L = 10\mu H$, $C_{OUT} = 22\mu F$, $R_{en} = 1M\Omega$, $T_A = +25^\circ C$, internal compensation, internal soft-start unless otherwise stated. (Cont.)

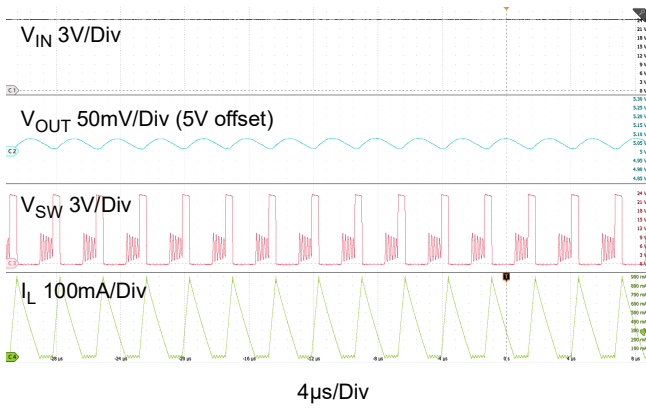

Figure 16. Typical Operation (Full Load)

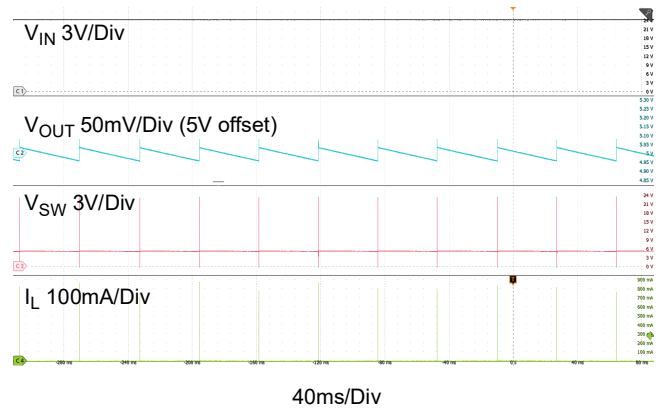

Figure 17. Typical Operation (No Load)

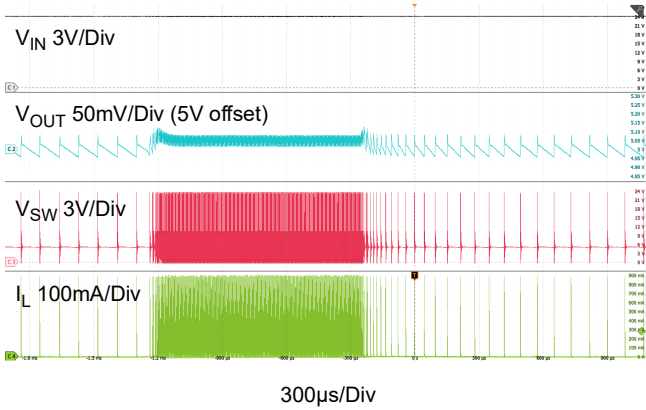

Figure 18. Load Transient (10mA to 300mA)

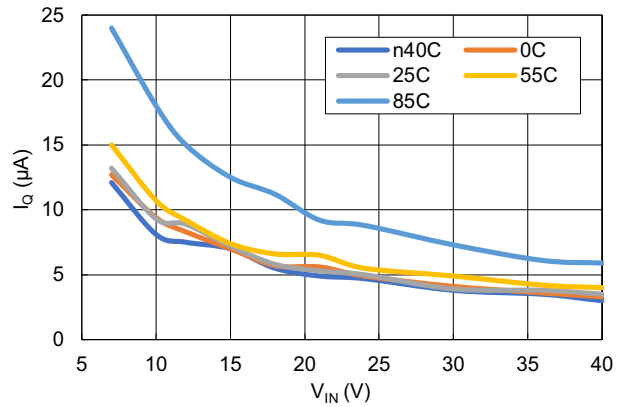

Figure 19. I_Q vs V_{IN} (In Regulation: No Load)

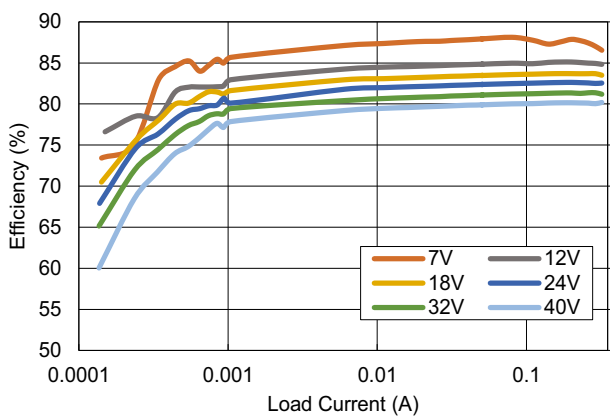

Figure 20. Efficiency

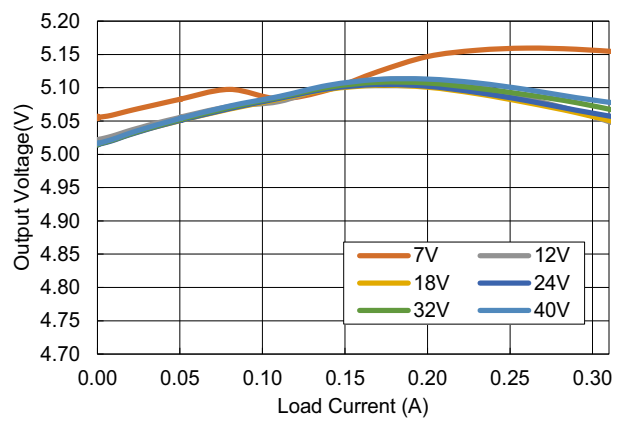

Figure 21. Load Regulation

4. Ordering Information

Part Number	Description
RTKA211405DE0000BU	RAA211405 TSOT23-5 evaluation board

5. Revision History

Revision	Date	Description
1.01	Dec 1, 2023	Updated Equation 1. Updated Figure 8 and 9.
1.00	May 8, 2023	Initial release

IMPORTANT NOTICE AND DISCLAIMER

RENESAS ELECTRONICS CORPORATION AND ITS SUBSIDIARIES (“RENESAS”) PROVIDES TECHNICAL SPECIFICATIONS AND RELIABILITY DATA (INCLUDING DATASHEETS), DESIGN RESOURCES (INCLUDING REFERENCE DESIGNS), APPLICATION OR OTHER DESIGN ADVICE, WEB TOOLS, SAFETY INFORMATION, AND OTHER RESOURCES “AS IS” AND WITH ALL FAULTS, AND DISCLAIMS ALL WARRANTIES, EXPRESS OR IMPLIED, INCLUDING, WITHOUT LIMITATION, ANY IMPLIED WARRANTIES OF MERCHANTABILITY, FITNESS FOR A PARTICULAR PURPOSE, OR NON-INFRINGEMENT OF THIRD PARTY INTELLECTUAL PROPERTY RIGHTS.

These resources are intended for developers skilled in the art designing with Renesas products. You are solely responsible for (1) selecting the appropriate products for your application, (2) designing, validating, and testing your application, and (3) ensuring your application meets applicable standards, and any other safety, security, or other requirements. These resources are subject to change without notice. Renesas grants you permission to use these resources only for development of an application that uses Renesas products. Other reproduction or use of these resources is strictly prohibited. No license is granted to any other Renesas intellectual property or to any third party intellectual property. Renesas disclaims responsibility for, and you will fully indemnify Renesas and its representatives against, any claims, damages, costs, losses, or liabilities arising out of your use of these resources. Renesas' products are provided only subject to Renesas' Terms and Conditions of Sale or other applicable terms agreed to in writing. No use of any Renesas resources expands or otherwise alters any applicable warranties or warranty disclaimers for these products.

(Disclaimer Rev.1.0 Mar 2020)

Corporate Headquarters

TOYOSU FORESIA, 3-2-24 Toyosu,
Koto-ku, Tokyo 135-0061, Japan
www.renesas.com

Contact Information

For further information on a product, technology, the most up-to-date version of a document, or your nearest sales office, please visit:
www.renesas.com/contact/

Trademarks

Renesas and the Renesas logo are trademarks of Renesas Electronics Corporation. All trademarks and registered trademarks are the property of their respective owners.

X-ON Electronics

Largest Supplier of Electrical and Electronic Components

Click to view similar products for [Power Management IC Development Tools](#) category:

Click to view products by [Renesas](#) manufacturer:

Other Similar products are found below :

[EVB-EP5348UI](#) [BQ25010EVM](#) [ISL80019AEVAL1Z](#) [ISLUSBI2CKIT1Z](#) [ISL8002AEVAL1Z](#) [ISL91108IIA-EVZ](#) [MAX8556EVKIT](#)
[MAX15005AEVKIT+](#) [ISL28022EVKIT1Z](#) [STEVAL-ISA008V1](#) [DRI0043](#) [KITPF8100FRDMEVM](#) [EVB-EN6337QA](#)
[SAMPLEBOXILD8150TOBO1](#) [MAX18066EVKIT#](#) [AP62300WU-EVM](#) [KITA2GTC387MOTORCTRTOBO1](#) [AEK-MOT-TK200G1](#)
[EVLONE65W](#) [STEVAL-ILH006V1](#) [STEVAL-IPE008V2](#) [STEVAL-IPP001V2](#) [STEVAL-ISA013V1](#) [STEVAL-ISA067V1](#) [STEVAL-](#)
[ISQ002V1](#) [TPS2306EVM-001](#) [TPS2330EVM-185](#) [TPS40001EVM-001](#) [SECO-HVDCDC1362-15W-GEVB](#) [BTS7030-2EPA](#)
[LT8638SJV#WPBF](#) [LTC3308AIV#WTRPBF](#) [TLT807B0EPV](#) [BTS71033-6ESA](#) [EV13N91A](#) [EASYPIC V8 OVER USB-C](#) [EV55W64A](#)
[CLICKER 4 FOR STM32F4](#) [EASYMX PRO V7A FOR STM32](#) [CLICKER 4 FOR PIC18F](#) [Si8285_86v2-KIT](#) [PAC52700EVK1](#) [NCP-](#)
[NCV51752D2PAK3LGEVB](#) [ISL81807EVAL1Z](#) [AP33772S-EVB](#) [EVALM7HVIGBTFCINV4TOBO1](#) [903-0300-000](#) [902-0173-000](#) [903-](#)
[0301-000](#) [ROA1286023/1](#)