

To our customers,

Old Company Name in Catalogs and Other Documents

On April 1st, 2010, NEC Electronics Corporation merged with Renesas Technology Corporation, and Renesas Electronics Corporation took over all the business of both companies. Therefore, although the old company name remains in this document, it is a valid Renesas Electronics document. We appreciate your understanding.

Renesas Electronics website: <http://www.renesas.com>

April 1st, 2010
Renesas Electronics Corporation

Issued by: Renesas Electronics Corporation (<http://www.renesas.com>)

Send any inquiries to <http://www.renesas.com/inquiry>.

Not recommended
for new design

Notice

1. All information included in this document is current as of the date this document is issued. Such information, however, is subject to change without any prior notice. Before purchasing or using any Renesas Electronics products listed herein, please confirm the latest product information with a Renesas Electronics sales office. Also, please pay regular and careful attention to additional and different information to be disclosed by Renesas Electronics such as that disclosed through our website.
2. Renesas Electronics does not assume any liability for infringement of patents, copyrights, or other intellectual property rights of third parties by or arising from the use of Renesas Electronics products or technical information described in this document. No license, express, implied or otherwise, is granted hereby under any patents, copyrights or other intellectual property rights of Renesas Electronics or others.
3. You should not alter, modify, copy, or otherwise misappropriate any Renesas Electronics product, whether in whole or in part.
4. Descriptions of circuits, software and other related information in this document are provided only to illustrate the operation of semiconductor products and application examples. You are fully responsible for the incorporation of these circuits, software, and information in the design of your equipment. Renesas Electronics assumes no responsibility for any losses incurred by you or third parties arising from the use of these circuits, software, or information.
5. When exporting the products or technology described in this document, you should comply with the applicable export control laws and regulations and follow the procedures required by such laws and regulations. You should not use Renesas Electronics products or the technology described in this document for any purpose relating to military applications or use by the military, including but not limited to the development of weapons of mass destruction. Renesas Electronics products and technology may not be used for or incorporated into any products or systems whose manufacture, use, or sale is prohibited under any applicable domestic or foreign laws or regulations.
6. Renesas Electronics has used reasonable care in preparing the information included in this document, but Renesas Electronics does not warrant that such information is error free. Renesas Electronics assumes no liability whatsoever for any damages incurred by you resulting from errors in or omissions from the information included herein.
7. Renesas Electronics products are classified according to the following three quality grades: “Standard”, “High Quality”, and “Specific”. The recommended applications for each Renesas Electronics product depends on the product’s quality grade, as indicated below. You must check the quality grade of each Renesas Electronics product before using it in a particular application. You may not use any Renesas Electronics product for any application categorized as “Specific” without the prior written consent of Renesas Electronics. Further, you may not use any Renesas Electronics product for any application for which it is not intended without the prior written consent of Renesas Electronics. Renesas Electronics shall not be in any way liable for any damages or losses incurred by you or third parties arising from the use of any Renesas Electronics product for an application categorized as “Specific” or for which the product is not intended where you have failed to obtain the prior written consent of Renesas Electronics. The quality grade of each Renesas Electronics product is “Standard” unless otherwise expressly specified in a Renesas Electronics data sheets or data books, etc.
 - “Standard”: Computers; office equipment; communications equipment; test and measurement equipment; audio and visual equipment; home electronic appliances; machine tools; personal electronic equipment; and industrial robots.
 - “High Quality”: Transportation equipment (automobiles, trains, ships, etc.); traffic control systems; anti-disaster systems; anti-crime systems; safety equipment; and medical equipment not specifically designed for life support.
 - “Specific”: Aircraft; aerospace equipment; submersible repeaters; nuclear reactor control systems; medical equipment or systems for life support (e.g. artificial life support devices or systems), surgical implantations, or healthcare intervention (e.g. excision, etc.), and any other applications or purposes that pose a direct threat to human life.
8. You should use the Renesas Electronics products described in this document within the range specified by Renesas Electronics, especially with respect to the maximum rating, operating supply voltage range, movement power voltage range, heat radiation characteristics, installation and other product characteristics. Renesas Electronics shall have no liability for malfunctions or damages arising out of the use of Renesas Electronics products beyond such specified ranges.
9. Although Renesas Electronics endeavors to improve the quality and reliability of its products, semiconductor products have specific characteristics such as the occurrence of failure at a certain rate and malfunctions under certain use conditions. Further, Renesas Electronics products are not subject to radiation resistance design. Please be sure to implement safety measures to guard them against the possibility of physical injury, and injury or damage caused by fire in the event of the failure of a Renesas Electronics product, such as safety design for hardware and software including but not limited to redundancy, fire control and malfunction prevention, appropriate treatment for aging degradation or any other appropriate measures. Because the evaluation of microcomputer software alone is very difficult, please evaluate the safety of the final products or system manufactured by you.
10. Please contact a Renesas Electronics sales office for details as to environmental matters such as the environmental compatibility of each Renesas Electronics product. Please use Renesas Electronics products in compliance with all applicable laws and regulations that regulate the inclusion or use of controlled substances, including without limitation, the EU RoHS Directive. Renesas Electronics assumes no liability for damages or losses occurring as a result of your noncompliance with applicable laws and regulations.
11. This document may not be reproduced or duplicated, in any form, in whole or in part, without prior written consent of Renesas Electronics.
12. Please contact a Renesas Electronics sales office if you have any questions regarding the information contained in this document or Renesas Electronics products, or if you have any other inquiries.

(Note 1) “Renesas Electronics” as used in this document means Renesas Electronics Corporation and also includes its majority-owned subsidiaries.

(Note 2) “Renesas Electronics product(s)” means any product developed or manufactured by or for Renesas Electronics.

BIPOLAR ANALOG INTEGRATED CIRCUIT
 μ PC29Mxx Series

THREE TERMINAL LOW DROPOUT VOLTAGE REGULATOR

The μ PC29Mxx series of low dropout voltage three terminal positive regulators is constructed with PNP output transistor. The μ PC29Mxx series feature the ability to source 0.5 A of output current with a low dropout voltage of typically 0.5 V.

The power dissipation of the μ PC29Mxx series can be drastically reduced compared with the conventional three terminal positive voltage regulators that is constructed with NPN output transistor. Also, this series corresponds to the low voltage output (3.0 V, 3.3 V) which is not in the conventional low dropout regulators (μ PC24MxxA series).

FEATURES

- Output current in excess of 0.5 A
- Low dropout voltage
 $V_{DIF} = 0.5 \text{ V TYP. (I}_o = 0.5 \text{ A)}$
- On-chip over-current and thermal protection circuit
- On-chip output transistor safe operating area protection circuit

<R>

PIN CONFIGURATIONS (Marking Side)

μ PC29MxxHF Series: Isolated TO-220 (MP-45G)

μ PC29MxxHB Series: SC-64 (MP-3)

μ PC29MxxT Series: SC-63 (MP-3Z)

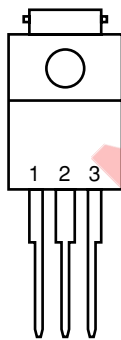

1: INPUT
 2: GND
 3: OUTPUT

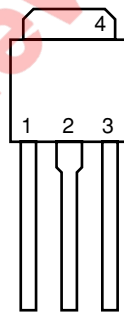

1: INPUT
 2: GND^{Note1}
 3: OUTPUT
 4: GND (Fin)

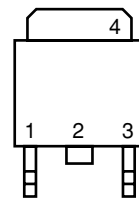

1: INPUT
 2: GND^{Note2}
 3: OUTPUT
 4: GND (Fin)

- Notes 1. No.2 pin and No.4 fin are common GND.
 2. No.2 pin is cut. No.2 pin and No.4 fin are common GND.

The information in this document is subject to change without notice. Before using this document, please confirm that this is the latest version.
 Not all products and/or types are available in every country. Please check with an NEC Electronics sales representative for availability and additional information.

BLOCK DIAGRAM

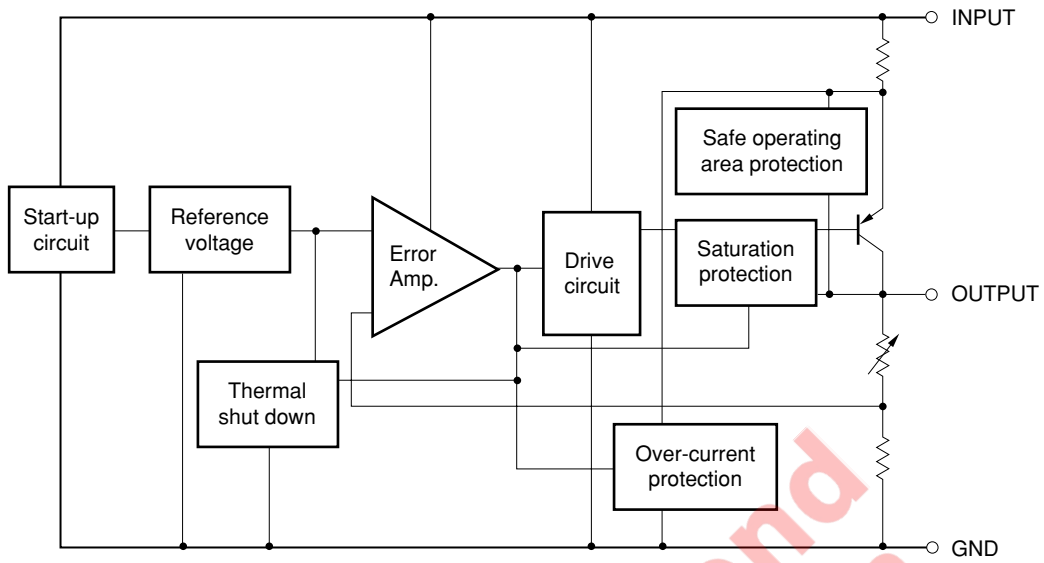

Not recommended for new design

<R>

ORDERING INFORMATION

| Part Number | Package | Output Voltage | Marking |
|-------------|--------------------------|----------------|---------|
| μPC29M03HF | Isolated TO-220 (MP-45G) | 3.0 V | 29M03 |
| μPC29M03HB | SC-64 (MP-3) | 3.0 V | 29M03 |
| μPC29M03T | SC-63 (MP-3Z) | 3.0 V | 29M03 |
| μPC29M33HF | Isolated TO-220 (MP-45G) | 3.3 V | 29M33 |
| μPC29M33HB | SC-64 (MP-3) | 3.3 V | 29M33 |
| μPC29M33T | SC-63 (MP-3Z) | 3.3 V | 29M33 |
| μPC29M05HF | Isolated TO-220 (MP-45G) | 5.0 V | 29M05 |
| μPC29M05HB | SC-64 (MP-3) | 5.0 V | 29M05 |
| μPC29M05T | SC-63 (MP-3Z) | 5.0 V | 29M05 |
| μPC29M06HF | Isolated TO-220 (MP-45G) | 6.0 V | 29M06 |
| μPC29M06HB | SC-64 (MP-3) | 6.0 V | 29M06 |
| μPC29M06T | SC-63 (MP-3Z) | 6.0 V | 29M06 |
| μPC29M07HF | Isolated TO-220 (MP-45G) | 7.0 V | 29M07 |
| μPC29M07HB | SC-64 (MP-3) | 7.0 V | 29M07 |
| μPC29M07T | SC-63 (MP-3Z) | 7.0 V | 29M07 |
| μPC29M08HF | Isolated TO-220 (MP-45G) | 8.0 V | 29M08 |
| μPC29M08HB | SC-64 (MP-3) | 8.0 V | 29M08 |
| μPC29M08T | SC-63 (MP-3Z) | 8.0 V | 29M08 |
| μPC29M09HF | Isolated TO-220 (MP-45G) | 9.0 V | 29M09 |
| μPC29M09HB | SC-64 (MP-3) | 9.0 V | 29M09 |
| μPC29M09T | SC-63 (MP-3Z) | 9.0 V | 29M09 |
| μPC29M10HF | Isolated TO-220 (MP-45G) | 10.0 V | 29M10 |
| μPC29M10HB | SC-64 (MP-3) | 10.0 V | 29M10 |
| μPC29M10T | SC-63 (MP-3Z) | 10.0 V | 29M10 |
| μPC29M12HF | Isolated TO-220 (MP-45G) | 12.0 V | 29M12 |
| μPC29M12HB | SC-64 (MP-3) | 12.0 V | 29M12 |
| μPC29M12T | SC-63 (MP-3Z) | 12.0 V | 29M12 |

Remark Tape-packaged products have the symbol -E1, or -E2 suffixed to the part number. Pb-free products have the symbol -AZ, or -AY suffixed to the part number. Refer to the following table for details.

| Part Number ^{Note1} | Package | Package Type |
|----------------------------------|--------------------------|---|
| μPC29MxxHF | Isolated TO-220 (MP-45G) | • Packed in envelop |
| μPC29MxxHF-AZ ^{Note2} | Isolated TO-220 (MP-45G) | • Packed in envelop |
| μPC29MxxHB | SC-64 (MP-3) | • Packed in envelop |
| μPC29MxxHB-AZ ^{Note2} | SC-64 (MP-3) | • Packed in envelop |
| μPC29MxxHB-AY ^{Note3} | SC-64 (MP-3) | • Packed in envelop |
| μPC29MxxT-E1 | SC-63 (MP-3Z) | • 16 mm wide embossed taping • Pin 1 on draw-out side • 2000 pcs/reel |
| μPC29MxxT-E1-AZ ^{Note2} | SC-63 (MP-3Z) | • 16 mm wide embossed taping • Pin 1 on draw-out side • 2000 pcs/reel |
| μPC29MxxT-E1-AY ^{Note3} | SC-63 (MP-3Z) | • 16 mm wide embossed taping • Pin 1 on draw-out side • 2000 pcs/reel |
| μPC29MxxT-E2 | SC-63 (MP-3Z) | • 16 mm wide embossed taping • Pin 1 at take-up side • 2000 pcs/reel |
| μPC29MxxT-E2-AZ ^{Note2} | SC-63 (MP-3Z) | • 16 mm wide embossed taping • Pin 1 at take-up side • 2000 pcs/reel |
| μPC29MxxT-E2-AY ^{Note3} | SC-63 (MP-3Z) | • 16 mm wide embossed taping • Pin 1 at take-up side • 2000 pcs/reel |

Notes 1. xx stands for symbols that indicate the output voltage.

2. Pb-free (This product does not contain Pb in the external electrode.)

3. Pb-free (This product does not contain Pb in the external electrode, Sn100% plating.)

ABSOLUTE MAXIMUM RATINGS (TA = 25°C, Unless otherwise specified.)

| Parameter | Symbol | Rating | | Unit |
|--|-----------------------|-------------|-----------------------|------|
| | | μPC29MxxHF | μPC29MxxHB, μPC29MxxT | |
| Input Voltage | V _{IN} | 20 | | V |
| Internal Power Dissipation (T _c = 25°C) Note | P _T | 15 | 10 | W |
| Operating Ambient Temperature | T _A | -30 to +85 | | °C |
| Operating Junction Temperature | T _J | -30 to +150 | | °C |
| Storage Temperature | T _{stg} | -55 to +150 | | °C |
| Thermal Resistance (Junction to Case) | R _{th (J-C)} | 7 | 12.5 | °C/W |
| Thermal Resistance (Junction to Ambient) | R _{th (J-A)} | 65 | 125 | °C/W |

Note Internally limited. When the operating junction temperature rises above 150°C, the internal circuit shuts down the output voltage.

Caution Product quality may suffer if the absolute maximum rating is exceeded even momentarily for any parameter. That is, the absolute maximum ratings are rated values at which the product is on the verge of suffering physical damage, and therefore the product must be used under conditions that ensure that the absolute maximum ratings are not exceeded.

TYPICAL CONNECTION

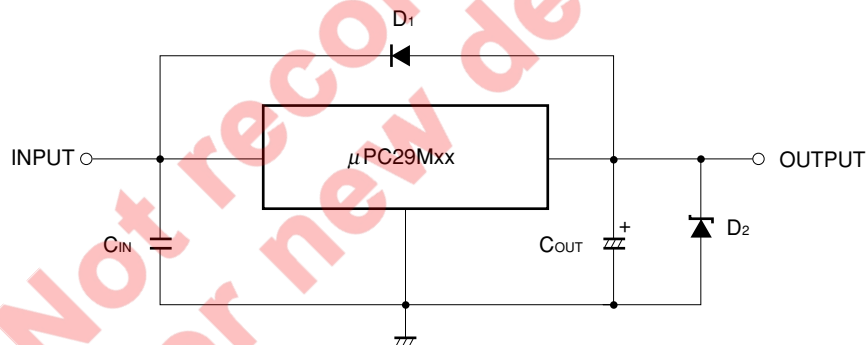

- C_{IN} : 0.1 μF or higher. Be sure to connect C_{IN} to prevent parasitic oscillation. Set this value according to the length of the line between the regulator and the INPUT pin. Use of a film capacitor or other capacitor with first-rate voltage and temperature characteristics is recommended. If using a laminated ceramic capacitor, it is necessary to ensure that C_{IN} is 0.1 μF or higher for the voltage and temperature range to be used.
- C_{OUT} : 47 μF or higher. Be sure to connect C_{OUT} to prevent oscillation and improve excessive load regulation. Place C_{IN} and C_{OUT} as close as possible to the IC pins (within 1 to 2 cm). Also, use an electrolytic capacitor with low impedance characteristics if considering use at sub-zero temperatures.
- D₁ : If the OUTPUT pin has a higher voltage than the INPUT pin, connect a diode.
- D₂ : If the OUTPUT pin has a lower voltage than the GND pin, connect a Schottky barrier diode.

Caution Make sure that no voltage is applied to the OUTPUT pin from external.

RECOMMENDED OPERATING CONDITIONS

| Parameter | Symbol | Type Number | MIN. | TYP. | MAX. | Unit |
|--------------------------------|-----------------|-------------|------|------|------|------|
| Input Voltage | V _{IN} | μPC29M03 | 4 | | 16 | V |
| | | μPC29M33 | 4.3 | | 16 | |
| | | μPC29M05 | 6 | | 16 | |
| | | μPC29M06 | 7 | | 16 | |
| | | μPC29M07 | 8 | | 16 | |
| | | μPC29M08 | 9 | | 18 | |
| | | μPC29M09 | 10 | | 18 | |
| | | μPC29M10 | 11 | | 18 | |
| | | μPC29M12 | 13 | | 18 | |
| Output Current | I _o | all | 0 | | 0.5 | A |
| Operating Ambient Temperature | T _A | all | -30 | | +85 | °C |
| Operating Junction Temperature | T _J | all | -30 | | +125 | °C |

ELECTRICAL CHARACTERISTICS

μPC29M03 (T_J = 25°C, V_{IN} = 5 V, I_o = 350 mA, C_{IN} = 0.22 μF, C_{OUT} = 47 μF, unless otherwise specified.)

| Parameters | Symbol | Conditions | MIN. | TYP. | MAX. | Unit |
|---|-----------------------|--|------|------|------|----------------------|
| Output Voltage | V _o | | 2.88 | 3.0 | 3.12 | V |
| | | 0°C ≤ T _J ≤ 125°C, 4.0 V ≤ V _{IN} ≤ 16 V, 0 A ≤ I _o ≤ 350 mA | 2.85 | | 3.15 | |
| | | 0°C ≤ T _J ≤ 125°C, 0 A ≤ I _o ≤ 0.5 A | | | | |
| Line Regulation | REG _{IN} | 4.0 V ≤ V _{IN} ≤ 16 V | | 7 | 30 | mV |
| Load Regulation | REG _L | 0 A ≤ I _o ≤ 0.5 A | | 8 | 30 | mV |
| Quiescent Current | I _{BIAS} | I _o = 0 A | | 1.8 | 4.0 | mA |
| | | I _o = 0.5 A | | 17 | 30 | |
| Startup Quiescent Current | I _{BIAS (s)} | V _{IN} = 2.95 V, I _o = 0 A | | 7 | 30 | mA |
| | | V _{IN} = 2.95 V, I _o = 0.5 A | | | 80 | |
| Quiescent Current Change | ΔI _{BIAS} | 0°C ≤ T _J ≤ 125°C, 4.0 V ≤ V _{IN} ≤ 16 V | | 3.2 | 20 | mA |
| Output Noise Voltage | V _n | 10 Hz ≤ f ≤ 100 kHz | | 51 | | μV _{r.m.s.} |
| Ripple Rejection | R·R | f = 120 Hz, 4.0 V ≤ V _{IN} ≤ 16 V | 48 | 64 | | dB |
| Dropout Voltage | V _{DIF} | 0°C ≤ T _J ≤ 125°C, I _o = 0.5 A | | 0.5 | 1.0 | V |
| Short Circuit Current | I _{O short} | V _{IN} = 4.5 V | 0.65 | 1.0 | 1.5 | A |
| | | V _{IN} = 16 V | | 0.6 | | |
| Peak Output Current | I _{o peak} | V _{IN} = 4.5 V | 0.7 | 1.0 | 1.5 | A |
| | | V _{IN} = 16 V | 0.6 | 0.9 | 1.5 | |
| Temperature Coefficient of Output Voltage | ΔV _o /ΔT | 0°C ≤ T _J ≤ 125°C, I _o = 5 mA | | -0.3 | | mV/°C |

μPC29M33 (T_J = 25°C, V_{IN} = 5 V, I_O = 350 mA, C_{IN} = 0.22 μF, C_{OUT} = 47 μF, unless otherwise specified.)

| Parameters | Symbol | Conditions | MIN. | TYP. | MAX. | Unit |
|---|-----------------------|--|------|------|------|----------------------|
| Output Voltage | V _O | | 3.17 | 3.3 | 3.43 | V |
| | | 0°C ≤ T _J ≤ 125°C, 4.3 V ≤ V _{IN} ≤ 16 V, 0 A ≤ I _O ≤ 350 mA | 3.14 | | 3.46 | |
| | | 0°C ≤ T _J ≤ 125°C, 0 A ≤ I _O ≤ 0.5 A | | | | |
| Line Regulation | REG _{IN} | 4.3 V ≤ V _{IN} ≤ 16 V | | 8 | 33 | mV |
| Load Regulation | REG _L | 0 A ≤ I _O ≤ 0.5 A | | 10 | 33 | mV |
| Quiescent Current | I _{BIAS} | I _O = 0 A | | 1.8 | 4.0 | mA |
| | | I _O = 0.5 A | | 15 | 30 | |
| Startup Quiescent Current | I _{BIAS (s)} | V _{IN} = 3.1 V, I _O = 0 A | | 9 | 30 | mA |
| | | V _{IN} = 3.1 V, I _O = 0.5 A | | | 80 | |
| Quiescent Current Change | ΔI _{BIAS} | 0°C ≤ T _J ≤ 125°C, 4.3 V ≤ V _{IN} ≤ 16 V | | 2.9 | 20 | mA |
| Output Noise Voltage | V _n | 10 Hz ≤ f ≤ 100 kHz | | 56 | | μV _{r.m.s.} |
| Ripple Rejection | R·R | f = 120 Hz, 4.3 V ≤ V _{IN} ≤ 16 V | 48 | 64 | | dB |
| Dropout Voltage | V _{DIF} | 0°C ≤ T _J ≤ 125°C, I _O = 0.5 A | | 0.5 | 1.0 | V |
| Short Circuit Current | I _{O short} | V _{IN} = 4.5 V | 0.7 | 1.1 | 1.5 | A |
| | | V _{IN} = 16 V | | 0.6 | | |
| Peak Output Current | I _{O peak} | V _{IN} = 4.5 V | 0.7 | 1.2 | 1.5 | A |
| | | V _{IN} = 16 V | 0.6 | 1.0 | 1.5 | |
| Temperature Coefficient of Output Voltage | ΔV _O /ΔT | 0°C ≤ T _J ≤ 125°C, I _O = 5 mA | | -0.4 | | mV/°C |

Not recommended for new design

μPC29M05 (T_J = 25°C, V_{IN} = 8 V, I_O = 350 mA, C_{IN} = 0.22 μF, C_{OUT} = 47 μF, unless otherwise specified.)

| Parameters | Symbol | Conditions | MIN. | TYP. | MAX. | Unit |
|---|-----------------------|--|------|------|------|----------------------|
| Output Voltage | V _O | | 4.8 | 5.0 | 5.2 | V |
| | | 0°C ≤ T _J ≤ 125°C, 6 V ≤ V _{IN} ≤ 16 V, 0 A ≤ I _O ≤ 350 mA | 4.75 | | 5.25 | |
| | | 0°C ≤ T _J ≤ 125°C, 0 A ≤ I _O ≤ 0.5 A | | | | |
| Line Regulation | REG _{IN} | 6 V ≤ V _{IN} ≤ 16 V | | 26 | 50 | mV |
| Load Regulation | REG _L | 0 A ≤ I _O ≤ 0.5 A | | 17 | 50 | mV |
| Quiescent Current | I _{BIAS} | I _O = 0 A | | 1.9 | 4.0 | mA |
| | | I _O = 0.5 A | | 16 | 30 | |
| Startup Quiescent Current | I _{BIAS} (s) | V _{IN} = 4.5 V, I _O = 0 A | | 10 | 30 | mA |
| | | V _{IN} = 4.5 V, I _O = 0.5 A | | | 80 | |
| Quiescent Current Change | ΔI _{BIAS} | 0°C ≤ T _J ≤ 125°C, 6 V ≤ V _{IN} ≤ 16 V | | 2.4 | 20 | mA |
| Output Noise Voltage | V _n | 10 Hz ≤ f ≤ 100 kHz | | 87 | | μV _{r.m.s.} |
| Ripple Rejection | R·R | f = 120 Hz, 6 V ≤ V _{IN} ≤ 16 V | 46 | 60 | | dB |
| Dropout Voltage | V _{DIF} | 0°C ≤ T _J ≤ 125°C, I _O = 0.5 A | | 0.5 | 1.0 | V |
| Short Circuit Current | I _{O short} | V _{IN} = 6.5 V | 0.65 | 1.1 | 1.5 | A |
| | | V _{IN} = 16 V | | 0.6 | | |
| Peak Output Current | I _{O peak} | V _{IN} = 6.5 V | 0.7 | 1.2 | 1.5 | A |
| | | V _{IN} = 16 V | 0.6 | 1.1 | 1.5 | |
| Temperature Coefficient of Output Voltage | ΔV _O /ΔT | 0°C ≤ T _J ≤ 125°C, I _O = 5 mA | | 0.7 | | mV/°C |

Not recommended for new design

μPC29M06 (T_J = 25°C, V_{IN} = 9 V, I_O = 350 mA, C_{IN} = 0.22 μF, C_{OUT} = 47 μF, unless otherwise specified.)

| Parameters | Symbol | Conditions | MIN. | TYP. | MAX. | Unit |
|---|-----------------------|--|------|------|------|----------------------|
| Output Voltage | V _O | | 5.76 | 6.0 | 6.24 | V |
| | | 0°C ≤ T _J ≤ 125°C, 7 V ≤ V _{IN} ≤ 16 V, 0 A ≤ I _O ≤ 350 mA | 5.70 | | 6.30 | |
| | | 0°C ≤ T _J ≤ 125°C, 0 A ≤ I _O ≤ 0.5 A | | | | |
| Line Regulation | REG _{IN} | 7 V ≤ V _{IN} ≤ 16 V | | 30 | 60 | mV |
| Load Regulation | REG _L | 0 A ≤ I _O ≤ 0.5 A | | 30 | 60 | mV |
| Quiescent Current | I _{BIAS} | I _O = 0 A | | 2.0 | 4.0 | mA |
| | | I _O = 0.5 A | | 16 | 30 | |
| Startup Quiescent Current | I _{BIAS (s)} | V _{IN} = 5.5 V, I _O = 0 A | | 10 | 30 | mA |
| | | V _{IN} = 5.5 V, I _O = 0.5 A | | | 80 | |
| Quiescent Current Change | ΔI _{BIAS} | 0°C ≤ T _J ≤ 125°C, 7 V ≤ V _{IN} ≤ 16 V | | 2.5 | 20 | mA |
| Output Noise Voltage | V _n | 10 Hz ≤ f ≤ 100 kHz | | 126 | | μV _{r.m.s.} |
| Ripple Rejection | R·R | f = 120 Hz, 7 V ≤ V _{IN} ≤ 16 V | 42 | 58 | | dB |
| Dropout Voltage | V _{DIF} | 0°C ≤ T _J ≤ 125°C, I _O = 0.5 A | | 0.5 | 1.0 | V |
| Short Circuit Current | I _{O short} | V _{IN} = 7.5 V | 0.7 | 1.1 | 1.5 | A |
| | | V _{IN} = 16 V | | 0.6 | | |
| Peak Output Current | I _{O peak} | V _{IN} = 7.5 V | 0.7 | 1.1 | 1.5 | A |
| | | V _{IN} = 16 V | 0.6 | 1.1 | 1.5 | |
| Temperature Coefficient of Output Voltage | ΔV _O /ΔT | 0°C ≤ T _J ≤ 125°C, I _O = 5 mA | | 0.44 | | mV/°C |

Not recommended for new design

μPC29M07 (T_J = 25°C, V_{IN} = 10 V, I_O = 350 mA, C_{IN} = 0.22 μF, C_{OUT} = 47 μF, unless otherwise specified.)

| Parameters | Symbol | Conditions | MIN. | TYP. | MAX. | Unit |
|---|-----------------------|--|------|------|------|----------------------|
| Output Voltage | V _O | | 6.72 | 7.0 | 7.28 | V |
| | | 0°C ≤ T _J ≤ 125°C, 8 V ≤ V _{IN} ≤ 16 V, 0 A ≤ I _O ≤ 350 mA | 6.65 | | 7.35 | |
| | | 0°C ≤ T _J ≤ 125°C, 0 A ≤ I _O ≤ 0.5 A | | | | |
| Line Regulation | REG _{IN} | 8 V ≤ V _{IN} ≤ 16 V | | 35 | 70 | mV |
| Load Regulation | REG _L | 0 A ≤ I _O ≤ 0.5 A | | 35 | 70 | mV |
| Quiescent Current | I _{BIAS} | I _O = 0 A | | 2.0 | 4.0 | mA |
| | | I _O = 0.5 A | | 16 | 30 | |
| Startup Quiescent Current | I _{BIAS} (s) | V _{IN} = 6.5 V, I _O = 0 A | | 10 | 30 | mA |
| | | V _{IN} = 6.5 V, I _O = 0.5 A | | | 80 | |
| Quiescent Current Change | ΔI _{BIAS} | 0°C ≤ T _J ≤ 125°C, 8 V ≤ V _{IN} ≤ 16 V | | 2.6 | 20 | mA |
| Output Noise Voltage | V _n | 10 Hz ≤ f ≤ 100 kHz | | 147 | | μV _{r.m.s.} |
| Ripple Rejection | R·R | f = 120 Hz, 8 V ≤ V _{IN} ≤ 16 V | 40 | 56 | | dB |
| Dropout Voltage | V _{DIF} | 0°C ≤ T _J ≤ 125°C, I _O = 0.5 A | | 0.5 | 1.0 | V |
| Short Circuit Current | I _{O short} | V _{IN} = 8.5 V | 0.7 | 1.1 | 1.5 | A |
| | | V _{IN} = 16 V | | 0.6 | | |
| Peak Output Current | I _{O peak} | V _{IN} = 8.5 V | 0.7 | 1.2 | 1.5 | A |
| | | V _{IN} = 16 V | 0.6 | 1.1 | 1.5 | |
| Temperature Coefficient of Output Voltage | ΔV _O /ΔT | 0°C ≤ T _J ≤ 125°C, I _O = 5 mA | | 0.7 | | mV/°C |

Not recommended for new design

μPC29M08 (T_J = 25°C, V_{IN} = 11 V, I_O = 350 mA, C_{IN} = 0.22 μF, C_{OUT} = 47 μF, unless otherwise specified.)

| Parameters | Symbol | Conditions | MIN. | TYP. | MAX. | Unit |
|---|-----------------------|--|------|------|------|----------------------|
| Output Voltage | V _O | | 7.68 | 8.0 | 8.32 | V |
| | | 0°C ≤ T _J ≤ 125°C, 9 V ≤ V _{IN} ≤ 18 V, 0 A ≤ I _O ≤ 350 mA | 7.6 | | 8.4 | |
| | | 0°C ≤ T _J ≤ 125°C, 0 A ≤ I _O ≤ 0.5 A | | | | |
| Line Regulation | REG _{IN} | 9 V ≤ V _{IN} ≤ 18 V | | 40 | 80 | mV |
| Load Regulation | REG _L | 0 A ≤ I _O ≤ 0.5 A | | 40 | 80 | mV |
| Quiescent Current | I _{BIAS} | I _O = 0 A | | 2.0 | 4.0 | mA |
| | | I _O = 0.5 A | | 15 | 30 | |
| Startup Quiescent Current | I _{BIAS (s)} | V _{IN} = 7.5 V, I _O = 0 A | | 10 | 30 | mA |
| | | V _{IN} = 7.5 V, I _O = 0.5 A | | | 80 | |
| Quiescent Current Change | ΔI _{BIAS} | 0°C ≤ T _J ≤ 125°C, 9 V ≤ V _{IN} ≤ 18 V | | 3.0 | 20 | mA |
| Output Noise Voltage | V _n | 10 Hz ≤ f ≤ 100 kHz | | 150 | | μV _{r.m.s.} |
| Ripple Rejection | R·R | f = 120 Hz, 9 V ≤ V _{IN} ≤ 18 V | 42 | 58 | | dB |
| Dropout Voltage | V _{DIF} | 0°C ≤ T _J ≤ 125°C, I _O = 0.5 A | | 0.5 | 1.0 | V |
| Short Circuit Current | I _{O short} | V _{IN} = 9.5 V | | 1.0 | | A |
| | | V _{IN} = 18 V | | 0.55 | | |
| Peak Output Current | I _{O peak} | V _{IN} = 9.5 V | 0.7 | 1.2 | 1.5 | A |
| | | V _{IN} = 18 V | 0.6 | 1.1 | 1.5 | |
| Temperature Coefficient of Output Voltage | ΔV _O /ΔT | 0°C ≤ T _J ≤ 125°C, I _O = 5 mA | | 0.7 | | mV/°C |

Not recommended for new design

μPC29M09 (T_J = 25°C, V_{IN} = 12 V, I_O = 350 mA, C_{IN} = 0.22 μF, C_{OUT} = 47 μF, unless otherwise specified.)

| Parameters | Symbol | Conditions | MIN. | TYP. | MAX. | Unit |
|---|-----------------------|---|------|------|------|----------------------|
| Output Voltage | V _O | | 8.64 | 9.0 | 9.36 | V |
| | | 0°C ≤ T _J ≤ 125°C, 10 V ≤ V _{IN} ≤ 18 V, 0 A ≤ I _O ≤ 350 mA | 8.55 | | 9.45 | |
| | | 0°C ≤ T _J ≤ 125°C, 0 A ≤ I _O ≤ 0.5 A | | | | |
| Line Regulation | REG _{IN} | 10 V ≤ V _{IN} ≤ 18 V | | 45 | 90 | mV |
| Load Regulation | REG _L | 0 A ≤ I _O ≤ 0.5 A | | 45 | 90 | mV |
| Quiescent Current | I _{BIAS} | I _O = 0 A | | 2.0 | 4.0 | mA |
| | | I _O = 0.5 A | | 15 | 30 | |
| Startup Quiescent Current | I _{BIAS (s)} | V _{IN} = 8.5 V, I _O = 0 A | | 10 | 30 | mA |
| | | V _{IN} = 8.5 V, I _O = 0.5 A | | | 80 | |
| Quiescent Current Change | ΔI _{BIAS} | 0°C ≤ T _J ≤ 125°C, 10 V ≤ V _{IN} ≤ 18 V | | | 20 | mA |
| Output Noise Voltage | V _n | 10 Hz ≤ f ≤ 100 kHz | | 170 | | μV _{r.m.s.} |
| Ripple Rejection | R·R | f = 120 Hz, 10 V ≤ V _{IN} ≤ 18 V | 41 | 57 | | dB |
| Dropout Voltage | V _{DIF} | 0°C ≤ T _J ≤ 125°C, I _O = 0.5 A | | 0.5 | 1.0 | V |
| Short Circuit Current | I _{O short} | V _{IN} = 10.5 V | | 1.0 | | A |
| | | V _{IN} = 18 V | | 0.55 | | |
| Peak Output Current | I _{O peak} | V _{IN} = 10.5 V | 0.7 | 1.2 | 1.5 | A |
| | | V _{IN} = 18 V | 0.6 | 1.1 | 1.5 | |
| Temperature Coefficient of Output Voltage | ΔV _O /ΔT | 0°C ≤ T _J ≤ 125°C, I _O = 5 mA | | 0.8 | | mV/°C |

Not recommended for new design

μPC29M10 (T_J = 25°C, V_{IN} = 13 V, I_O = 350 mA, C_{IN} = 0.22 μF, C_{OUT} = 47 μF, unless otherwise specified.)

| Parameters | Symbol | Conditions | MIN. | TYP. | MAX. | Unit |
|---|-----------------------|---|------|------|------|----------------------|
| Output Voltage | V _O | | 9.6 | 10.0 | 10.4 | V |
| | | 0°C ≤ T _J ≤ 125°C, 11 V ≤ V _{IN} ≤ 18 V, 0 A ≤ I _O ≤ 350 mA | 9.5 | | 10.5 | |
| | | 0°C ≤ T _J ≤ 125°C, 0 A ≤ I _O ≤ 0.5 A | | | | |
| Line Regulation | REG _{IN} | 11 V ≤ V _{IN} ≤ 18 V | | 34 | 100 | mV |
| Load Regulation | REG _L | 0 A ≤ I _O ≤ 0.5 A | | 10 | 100 | mV |
| Quiescent Current | I _{BIAS} | I _O = 0 A | | 2.1 | 4.0 | mA |
| | | I _O = 0.5 A | | 16 | 30 | |
| Startup Quiescent Current | I _{BIAS (s)} | V _{IN} = 9.5 V, I _O = 0 A | | 10 | 30 | mA |
| | | V _{IN} = 9.5 V, I _O = 0.5 A | | | 80 | |
| Quiescent Current Change | ΔI _{BIAS} | 0°C ≤ T _J ≤ 125°C, 11 V ≤ V _{IN} ≤ 18 V | | 1.9 | 20 | mA |
| Output Noise Voltage | V _n | 10 Hz ≤ f ≤ 100 kHz | | 180 | | μV _{r.m.s.} |
| Ripple Rejection | R·R | f = 120 Hz, 11 V ≤ V _{IN} ≤ 18 V | 40 | 53 | | dB |
| Dropout Voltage | V _{DIF} | 0°C ≤ T _J ≤ 125°C, I _O = 0.5 A | | 0.5 | 1.0 | V |
| Short Circuit Current | I _{O short} | V _{IN} = 11.5 V | | 0.9 | | A |
| | | V _{IN} = 18 V | | 0.5 | | |
| Peak Output Current | I _{O peak} | V _{IN} = 11.5 V | 0.7 | 1.2 | 1.5 | A |
| | | V _{IN} = 18 V | 0.6 | 1.2 | 1.5 | |
| Temperature Coefficient of Output Voltage | ΔV _O /ΔT | 0°C ≤ T _J ≤ 125°C, I _O = 5 mA | | 0.9 | | mV/°C |

Not recommended for new design

μPC29M12 (T_J = 25°C, V_{IN} = 15 V, I_O = 350 mA, C_{IN} = 0.22 μF, C_{OUT} = 47 μF, unless otherwise specified.)

| Parameters | Symbol | Conditions | MIN. | TYP. | MAX. | Unit |
|---|-----------------------|---|-------|------|-------|----------------------|
| Output Voltage | V _O | | 11.52 | 12 | 12.48 | V |
| | | 0°C ≤ T _J ≤ 125°C, 13 V ≤ V _{IN} ≤ 18 V, 0 A ≤ I _O ≤ 350 mA | 11.4 | | 12.6 | |
| | | 0°C ≤ T _J ≤ 125°C, 0 A ≤ I _O ≤ 0.5 A | | | | |
| Line Regulation | REG _{IN} | 13 V ≤ V _{IN} ≤ 18 V | | 25 | 120 | mV |
| Load Regulation | REG _L | 0 A ≤ I _O ≤ 0.5 A | | 13 | 120 | mV |
| Quiescent Current | I _{BIAS} | I _O = 0 A | | 2.1 | 4.0 | mA |
| | | I _O = 0.5 A | | 14 | 30 | |
| Startup Quiescent Current | I _{BIAS} (s) | V _{IN} = 11.5 V, I _O = 0 A | | 10 | 30 | mA |
| | | V _{IN} = 11.5 V, I _O = 0.5 A | | | 80 | |
| Quiescent Current Change | ΔI _{BIAS} | 0°C ≤ T _J ≤ 125°C, 13 V ≤ V _{IN} ≤ 18 V | | 1.7 | 20 | mA |
| Output Noise Voltage | V _n | 10 Hz ≤ f ≤ 100 kHz | | 210 | | μV _{r.m.s.} |
| Ripple Rejection | R·R | f = 120 Hz, 13 V ≤ V _{IN} ≤ 18 V | 40 | 53 | | dB |
| Dropout Voltage | V _{DIF} | 0°C ≤ T _J ≤ 125°C, I _O = 0.5 A | | 0.5 | 1.0 | V |
| Short Circuit Current | I _{O short} | V _{IN} = 14 V | | 0.7 | | A |
| | | V _{IN} = 18 V | | 0.5 | | |
| Peak Output Current | I _{O peak} | V _{IN} = 14 V | 0.7 | 1.2 | 1.5 | A |
| | | V _{IN} = 18 V | 0.6 | 1.1 | 1.5 | |
| Temperature Coefficient of Output Voltage | ΔV _O /ΔT | 0°C ≤ T _J ≤ 125°C, I _O = 5 mA | | 1.2 | | mV/°C |

Not recommended for new design

TYPICAL CHARACTERISTICS

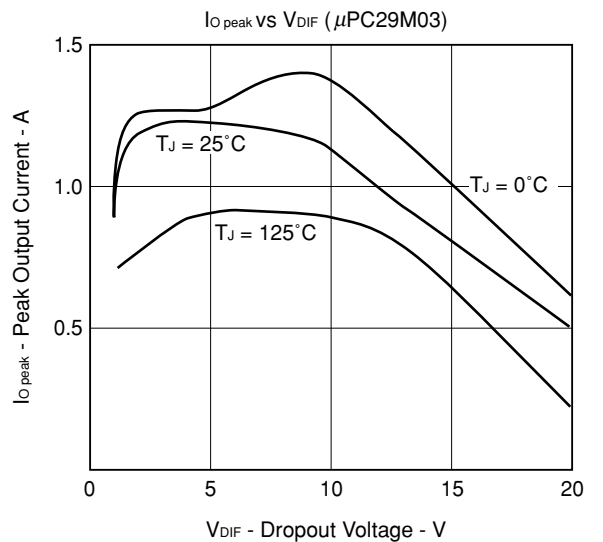
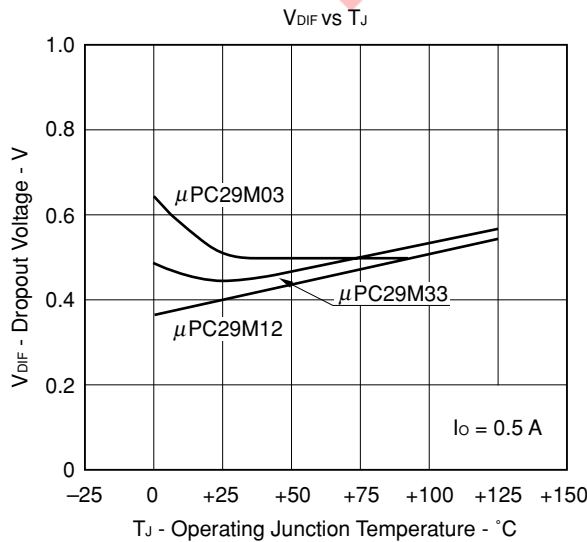
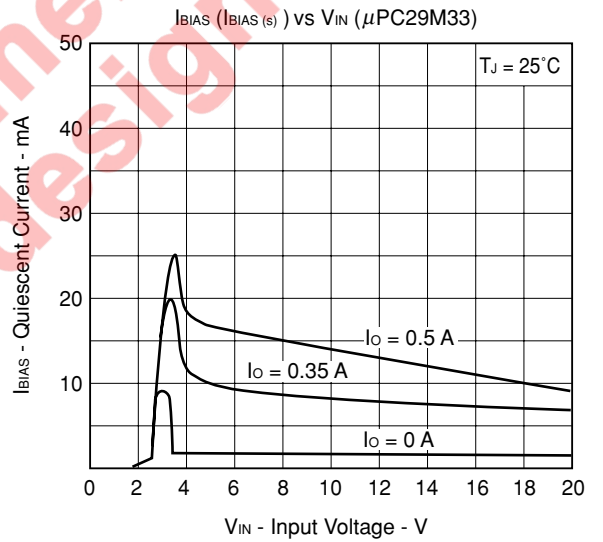
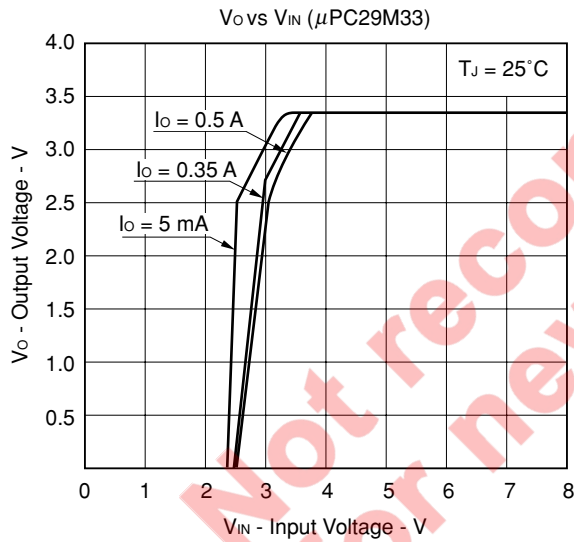
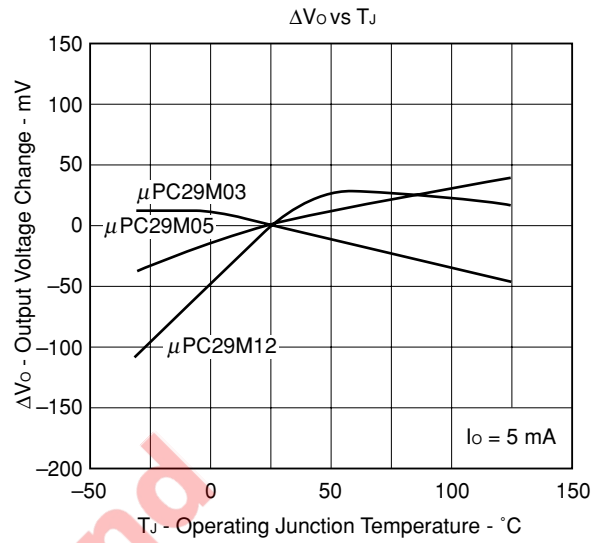
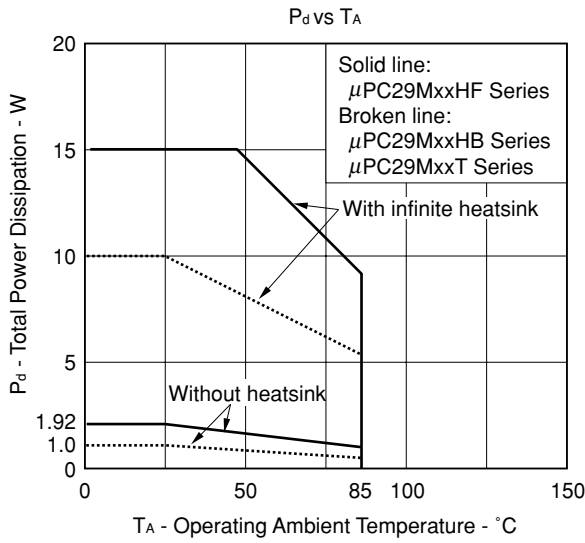

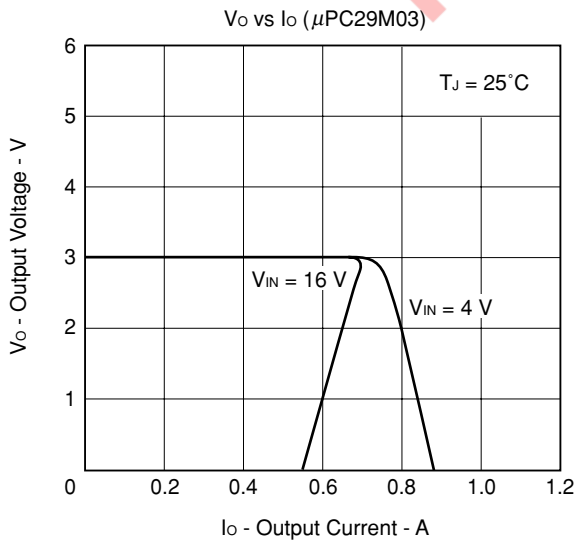
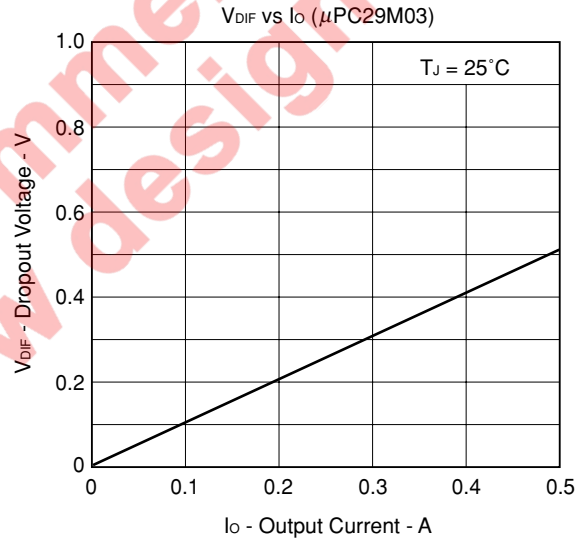
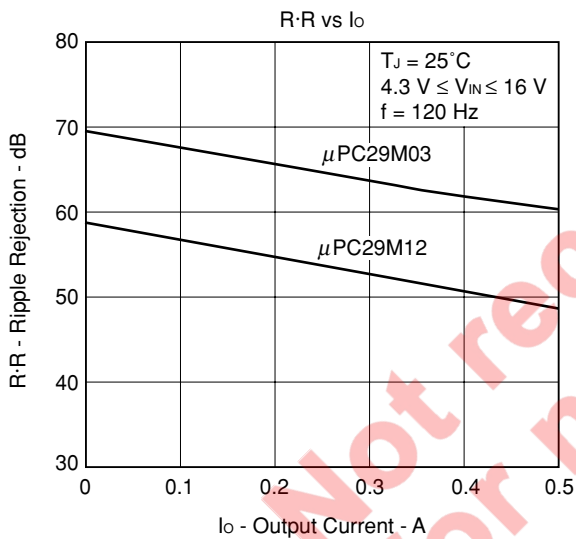
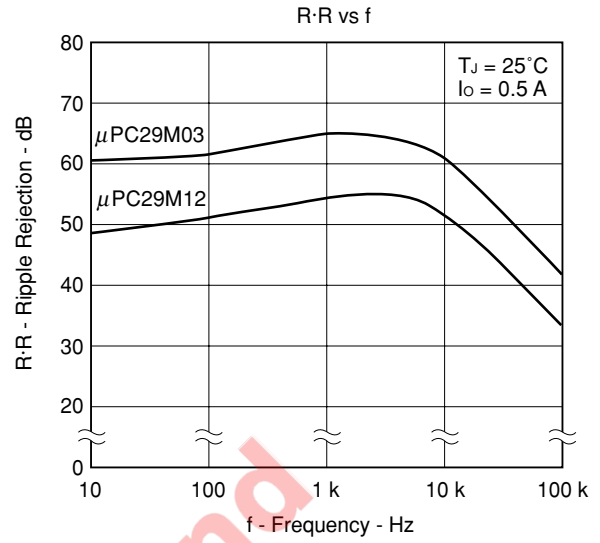
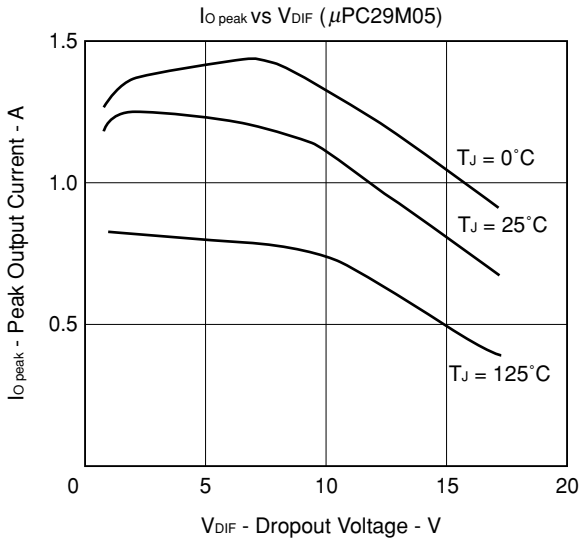

PACKAGE DRAWINGS

μPC29MxxHF Series

3PIN PLASTIC SIP (MP-45G)

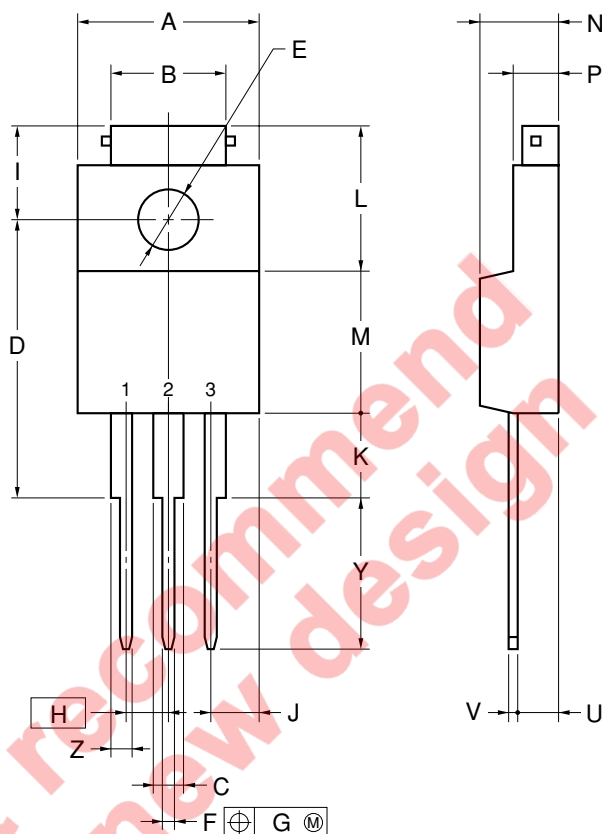

NOTE
 Each lead centerline is located within 0.25 mm of its true position (T.P.) at maximum material condition.

| ITEM | MILLIMETERS |
|------|-------------|
| A | 10.0±0.2 |
| B | 7.0±0.2 |
| C | 1.50±0.2 |
| D | 17.0±0.3 |
| E | φ3.3±0.2 |
| F | 0.75±0.10 |
| G | 0.25 |
| H | 2.54 (T.P.) |
| I | 5.0±0.3 |
| J | 2.46±0.2 |
| K | 5.0±0.2 |
| L | 8.5±0.2 |
| M | 8.5±0.2 |
| N | 4.5±0.2 |
| P | 2.8±0.2 |
| U | 2.4±0.5 |
| V | 0.65±0.10 |
| Y | 8.9±0.7 |
| Z | 1.30±0.2 |

P3HF-254B-4

μPC29MxxHB Series

SC-64 (MP-3) (Unit: mm)

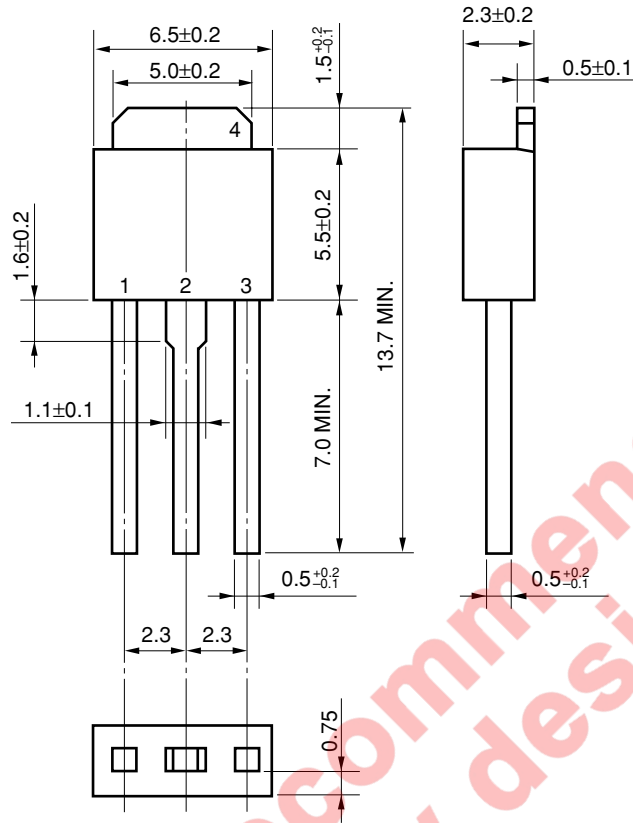

μPC29MxxT Series

<R> SC-63 (MP-3Z) (Unit: mm)

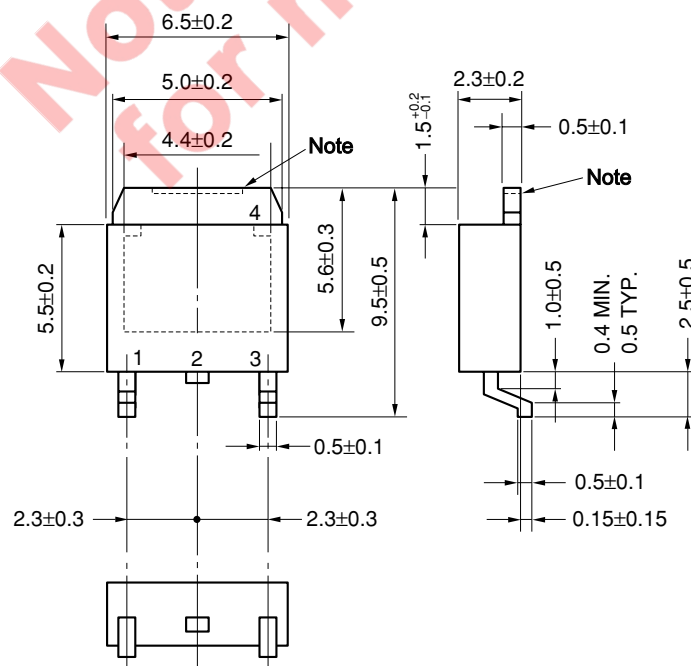

Note The depth of notch at the top of the fin is from 0 to 0.2 mm.

<R> **RECOMMENDED SOLDERING CONDITIONS**

When soldering this product, it is highly recommended to observe the conditions as shown below. If other soldering processes are used, or if the soldering is performed under different condition, please make sure to consult with our sales offices.

For more details, refer to the **Semiconductor Device Mount Manual**
 (<http://www.necel.com/pkg/en/mount/index.html>)

Surface mount devices

μPC29MxxT Series: SC-63 (MP-3Z)

| Process | Conditions | Symbol |
|------------------------|--|-----------|
| Infrared ray reflow | Peak temperature: 235°C or below (Package surface temperature), Reflow time: 30 seconds or less (at 210°C or higher), Maximum number of reflow processes: 3 times or less. | IR35-00-3 |
| VPS | Peak temperature: 215°C or below (Package surface temperature), Reflow time: 40 seconds or less (at 200°C or higher), Maximum number of reflow processes: 3 times or less. | VP15-00-3 |
| Partial heating method | Pin temperature: 350°C or below, Heat time: 3 seconds or less (Per each side of the device). | P350 |

Caution Apply only one kind of soldering condition to a device, except for “partial heating method”, or the device will be damaged by heat stress.

Remark Flux: Rosin-based flux with low chlorine content (chlorine 0.2 Wt% or below) is recommended.

μPC29MxxT-AZ Series ^{Note1}, μPC29MxxT-AY Series ^{Note2}: SC-63 (MP-3Z)

| Process | Conditions | Symbol |
|------------------------|--|-----------|
| Infrared ray reflow | Peak temperature: 260°C or below (Package surface temperature), Reflow time: 60 seconds or less (at 220°C or higher), Maximum number of reflow processes: 3 times or less. | IR60-00-3 |
| Partial heating method | Pin temperature: 350°C or below, Heat time: 3 seconds or less (Per each side of the device). | P350 |

- Notes**
1. Pb-free (This product does not contain Pb in the external electrode.)
 2. Pb-free (This product does not contain Pb in the external electrode, Sn100% plating.)

Caution Apply only one kind of soldering condition to a device, except for “partial heating method”, or the device will be damaged by heat stress.

Remark Flux: Rosin-based flux with low chlorine content (chlorine 0.2 Wt% or below) is recommended.

Through-hole devices

μPC29MxxHF Series, μPC29MxxHF-AZ Series ^{Note1}: Isolated TO-220 (MP-45G)

μPC29MxxHB Series, μPC29MxxHB-AZ Series ^{Note1}, μPC29MxxHB-AY Series ^{Note2}: SC-64 (MP-3)

| Process | Conditions | Symbol |
|-----------------------------------|--|-----------|
| Wave soldering (only to leads) | Solder temperature: 260°C or below, Flow time: 10 seconds or less. | WS60-00-1 |
| Partial heating method | Pin temperature: 350°C or below, Heat time: 3 seconds or less (Per each pin). | P350 |

Notes 1. Pb-free (This product does not contain Pb in the external electrode.)

2. Pb-free (This product does not contain Pb in the external electrode, Sn100% plating.)

Caution For through-hole device, the wave soldering process must be applied only to leads, and make sure that the package body does not get jet soldered.

CAUTION ON USE

When using the μPC29Mxx series at the input voltage which is lower than in the recommended operating condition, the high quiescent current flows through devices because the transistor of the output paragraph is saturated (Refer to “IBIAS (IBIAS(s)) vs VIN curves in TYPICAL CHARACTERISTICS”). The μPC29Mxx series have saturation protection circuits, but they sometimes need about 80 mA current. Therefore the power supply on the input needs the enough current capacity to pass this quiescent current when the devices startup.

<R> **REFERENCE DOCUMENTS**

| | |
|--|---|
| USER'S MANUAL USAGE OF THREE TERMINAL REGULATORS | Document No.G12702E |
| REVIEW OF QUALITY AND RELIABILITY HANDBOOK | Document No.C12769E |
| INFORMATION VOLTAGE REGULATOR OF SMD | Document No.G11872E |
| SEMICONDUCTOR DEVICE MOUNT MANUAL | http://www.necel.com/pkg/en/mount/index.html |

- **The information in this document is current as of September, 2007. The information is subject to change without notice. For actual design-in, refer to the latest publications of NEC Electronics data sheets or data books, etc., for the most up-to-date specifications of NEC Electronics products. Not all products and/or types are available in every country. Please check with an NEC Electronics sales representative for availability and additional information.**
- No part of this document may be copied or reproduced in any form or by any means without the prior written consent of NEC Electronics. NEC Electronics assumes no responsibility for any errors that may appear in this document.
- NEC Electronics does not assume any liability for infringement of patents, copyrights or other intellectual property rights of third parties by or arising from the use of NEC Electronics products listed in this document or any other liability arising from the use of such products. No license, express, implied or otherwise, is granted under any patents, copyrights or other intellectual property rights of NEC Electronics or others.
- Descriptions of circuits, software and other related information in this document are provided for illustrative purposes in semiconductor product operation and application examples. The incorporation of these circuits, software and information in the design of a customer's equipment shall be done under the full responsibility of the customer. NEC Electronics assumes no responsibility for any losses incurred by customers or third parties arising from the use of these circuits, software and information.
- While NEC Electronics endeavors to enhance the quality, reliability and safety of NEC Electronics products, customers agree and acknowledge that the possibility of defects thereof cannot be eliminated entirely. To minimize risks of damage to property or injury (including death) to persons arising from defects in NEC Electronics products, customers must incorporate sufficient safety measures in their design, such as redundancy, fire-containment and anti-failure features.
- NEC Electronics products are classified into the following three quality grades: "Standard", "Special" and "Specific".

The "Specific" quality grade applies only to NEC Electronics products developed based on a customer-designated "quality assurance program" for a specific application. The recommended applications of an NEC Electronics product depend on its quality grade, as indicated below. Customers must check the quality grade of each NEC Electronics product before using it in a particular application.

"Standard": Computers, office equipment, communications equipment, test and measurement equipment, audio and visual equipment, home electronic appliances, machine tools, personal electronic equipment and industrial robots.

"Special": Transportation equipment (automobiles, trains, ships, etc.), traffic control systems, anti-disaster systems, anti-crime systems, safety equipment and medical equipment (not specifically designed for life support).

"Specific": Aircraft, aerospace equipment, submersible repeaters, nuclear reactor control systems, life support systems and medical equipment for life support, etc.

The quality grade of NEC Electronics products is "Standard" unless otherwise expressly specified in NEC Electronics data sheets or data books, etc. If customers wish to use NEC Electronics products in applications not intended by NEC Electronics, they must contact an NEC Electronics sales representative in advance to determine NEC Electronics' willingness to support a given application.

(Note)

- (1) "NEC Electronics" as used in this statement means NEC Electronics Corporation and also includes its majority-owned subsidiaries.
- (2) "NEC Electronics products" means any product developed or manufactured by or for NEC Electronics (as defined above).

X-ON Electronics

Largest Supplier of Electrical and Electronic Components

Click to view similar products for [LDO Voltage Regulators](#) category:

Click to view products by [Renesas](#) manufacturer:

Other Similar products are found below :

[M38D29FFHP#U1](#) [702103A](#) [717726C](#) [742457H](#) [MP20051DN-LF-Z](#) [R5F111PGGFB#30](#) [AP7363-SP-13](#) [NCP103AMX285TCG](#)
[NCV8664CST33T3G](#) [NCV8752AMX28TCG](#) [L9454](#) [AP7362-HA-7](#) [LX13043CLD](#) [TCR3DF185,LM\(CT](#) [TCR3DF24,LM\(CT](#)
[TCR3DF285,LM\(CT](#) [TCR3DF31,LM\(CT](#) [TCR3DF45,LM\(CT](#) [TLF4949EJ](#) [L9708](#) [L970813TR](#) [030014BB](#) [059985X](#) [EAN61387601](#)
[EAN61573601](#) [NCP121AMX173TCG](#) [NCP4687DH15T1G](#) [NCV8703MX30TCG](#) [701326R](#) [702087BB](#) [755078E](#) [TCR2EN28,LF\(S](#)
[LM1117DT-1.8/NO](#) [LT1086CM#TRPBF](#) [AZ1085S2-1.5TRE1](#) [MAX15101EWL+T](#) [NCV8170AXV250T2G](#) [SCD337BTG](#)
[TCR3DF27,LM\(CT](#) [TCR3DF19,LM\(CT](#) [TCR3DF125,LM\(CT](#) [TCR2EN18,LF\(S](#) [MAX15103EWL+T](#) [TS2937CZ-5.0 C0](#) [MAX8878EUK30-](#)
[T](#) [MAX663CPA](#) [NCV4269CPD50R2G](#) [NCV8716MT30TBG](#) [AZ1117IH-1.2TRG1](#) [MP2013GQ-P](#)