

To our customers,

---

## Old Company Name in Catalogs and Other Documents

---

On April 1<sup>st</sup>, 2010, NEC Electronics Corporation merged with Renesas Technology Corporation, and Renesas Electronics Corporation took over all the business of both companies. Therefore, although the old company name remains in this document, it is a valid Renesas Electronics document. We appreciate your understanding.

Renesas Electronics website: <http://www.renesas.com>

April 1<sup>st</sup>, 2010  
Renesas Electronics Corporation

Issued by: Renesas Electronics Corporation (<http://www.renesas.com>)

Send any inquiries to <http://www.renesas.com/inquiry>.

## Notice

1. All information included in this document is current as of the date this document is issued. Such information, however, is subject to change without any prior notice. Before purchasing or using any Renesas Electronics products listed herein, please confirm the latest product information with a Renesas Electronics sales office. Also, please pay regular and careful attention to additional and different information to be disclosed by Renesas Electronics such as that disclosed through our website.
2. Renesas Electronics does not assume any liability for infringement of patents, copyrights, or other intellectual property rights of third parties by or arising from the use of Renesas Electronics products or technical information described in this document. No license, express, implied or otherwise, is granted hereby under any patents, copyrights or other intellectual property rights of Renesas Electronics or others.
3. You should not alter, modify, copy, or otherwise misappropriate any Renesas Electronics product, whether in whole or in part.
4. Descriptions of circuits, software and other related information in this document are provided only to illustrate the operation of semiconductor products and application examples. You are fully responsible for the incorporation of these circuits, software, and information in the design of your equipment. Renesas Electronics assumes no responsibility for any losses incurred by you or third parties arising from the use of these circuits, software, or information.
5. When exporting the products or technology described in this document, you should comply with the applicable export control laws and regulations and follow the procedures required by such laws and regulations. You should not use Renesas Electronics products or the technology described in this document for any purpose relating to military applications or use by the military, including but not limited to the development of weapons of mass destruction. Renesas Electronics products and technology may not be used for or incorporated into any products or systems whose manufacture, use, or sale is prohibited under any applicable domestic or foreign laws or regulations.
6. Renesas Electronics has used reasonable care in preparing the information included in this document, but Renesas Electronics does not warrant that such information is error free. Renesas Electronics assumes no liability whatsoever for any damages incurred by you resulting from errors in or omissions from the information included herein.
7. Renesas Electronics products are classified according to the following three quality grades: “Standard”, “High Quality”, and “Specific”. The recommended applications for each Renesas Electronics product depends on the product’s quality grade, as indicated below. You must check the quality grade of each Renesas Electronics product before using it in a particular application. You may not use any Renesas Electronics product for any application categorized as “Specific” without the prior written consent of Renesas Electronics. Further, you may not use any Renesas Electronics product for any application for which it is not intended without the prior written consent of Renesas Electronics. Renesas Electronics shall not be in any way liable for any damages or losses incurred by you or third parties arising from the use of any Renesas Electronics product for an application categorized as “Specific” or for which the product is not intended where you have failed to obtain the prior written consent of Renesas Electronics. The quality grade of each Renesas Electronics product is “Standard” unless otherwise expressly specified in a Renesas Electronics data sheets or data books, etc.
  - “Standard”: Computers; office equipment; communications equipment; test and measurement equipment; audio and visual equipment; home electronic appliances; machine tools; personal electronic equipment; and industrial robots.
  - “High Quality”: Transportation equipment (automobiles, trains, ships, etc.); traffic control systems; anti-disaster systems; anti-crime systems; safety equipment; and medical equipment not specifically designed for life support.
  - “Specific”: Aircraft; aerospace equipment; submersible repeaters; nuclear reactor control systems; medical equipment or systems for life support (e.g. artificial life support devices or systems), surgical implantations, or healthcare intervention (e.g. excision, etc.), and any other applications or purposes that pose a direct threat to human life.
8. You should use the Renesas Electronics products described in this document within the range specified by Renesas Electronics, especially with respect to the maximum rating, operating supply voltage range, movement power voltage range, heat radiation characteristics, installation and other product characteristics. Renesas Electronics shall have no liability for malfunctions or damages arising out of the use of Renesas Electronics products beyond such specified ranges.
9. Although Renesas Electronics endeavors to improve the quality and reliability of its products, semiconductor products have specific characteristics such as the occurrence of failure at a certain rate and malfunctions under certain use conditions. Further, Renesas Electronics products are not subject to radiation resistance design. Please be sure to implement safety measures to guard them against the possibility of physical injury, and injury or damage caused by fire in the event of the failure of a Renesas Electronics product, such as safety design for hardware and software including but not limited to redundancy, fire control and malfunction prevention, appropriate treatment for aging degradation or any other appropriate measures. Because the evaluation of microcomputer software alone is very difficult, please evaluate the safety of the final products or system manufactured by you.
10. Please contact a Renesas Electronics sales office for details as to environmental matters such as the environmental compatibility of each Renesas Electronics product. Please use Renesas Electronics products in compliance with all applicable laws and regulations that regulate the inclusion or use of controlled substances, including without limitation, the EU RoHS Directive. Renesas Electronics assumes no liability for damages or losses occurring as a result of your noncompliance with applicable laws and regulations.
11. This document may not be reproduced or duplicated, in any form, in whole or in part, without prior written consent of Renesas Electronics.
12. Please contact a Renesas Electronics sales office if you have any questions regarding the information contained in this document or Renesas Electronics products, or if you have any other inquiries.

(Note 1) “Renesas Electronics” as used in this document means Renesas Electronics Corporation and also includes its majority-owned subsidiaries.

(Note 2) “Renesas Electronics product(s)” means any product developed or manufactured by or for Renesas Electronics.

**LOW-POWER, HIGH-STABILITY, LOW-OFFSET VOLTAGE  
J-FET INPUT DUAL OPERATIONAL AMPLIFIER**

**DESCRIPTION**

The μPC835 is the higher version of μPC832 and 4062, the J-FET input operational amplifiers, in stability and accuracy. The μPC835 is a J-FET input dual operational amplifier which realizes both low power consumption and high stability, by adopting a high speed PNP transistor of  $f_T = 300$  MHz on its output stage.

In addition, despite its J-FET input, the μPC835 realizes low offset voltage characteristics that eclipses conventional general operational amplifiers, by using a resistance trimming system, the proven method for our high accuracy operational amplifier and high accuracy reference voltage.

The μPC835 is ideal for use in measurement instruments and control instruments, which especially requires the stability during capacitive load connections.

**FEATURES**

- Input offset voltage  $\pm 3$  mV MAX.
- Slew rate  $5.5$  V/ $\mu$ s TYP.
- Unity gain frequency  $2.8$  MHz TYP.
- Low power  $I_{CC} \leq 2.2$  mA MAX.  
(Reduces circuit currents while maintaining relatively high slew rate and bandwidth)
- High stability is secured to capacitive loads  
( $4000$  pF,  $A_V = +1$ )
- Internal frequency compensation
- Small package

The whole size of the package is downsized by 30 to 40% compared with a standard SOP contour, by using a TSSOP ( $3 \times 3$  mm<sup>2</sup> body) package

**ORDERING INFORMATION**

Part Number	Package	Packing Type
μPC835MN-KAA-E1-AT <sup>Note</sup>	8-pin plastic TSSOP (3 x 3)	<ul style="list-style-type: none"> <li>• 12 mm wide embossed taping</li> <li>• Pin 1 at draw-out side</li> <li>• 4000 p/reel</li> </ul>
μPC835MN-KAA-E2-AT <sup>Note</sup>	8-pin plastic TSSOP (3 x 3)	<ul style="list-style-type: none"> <li>• 12 mm wide embossed taping</li> <li>• Pin 1 at reel side</li> <li>• 4000 p/reel</li> </ul>

**Note** Pb-free (This product does not contain Pb in the external electrode and other parts.)

The information in this document is subject to change without notice. Before using this document, please confirm that this is the latest version.  
Not all products and/or types are available in every country. Please check with an NEC Electronics sales representative for availability and additional information.

**EQUIVALENT CIRCUIT (1/2 Circuit)**

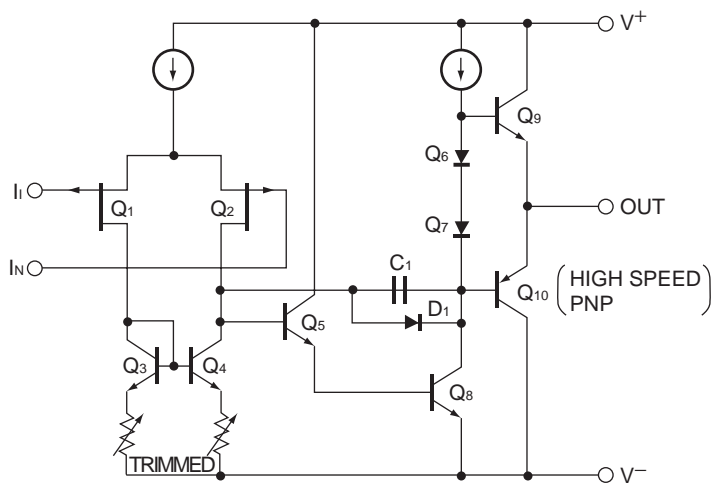

**PIN CONFIGURATION (Top View)**

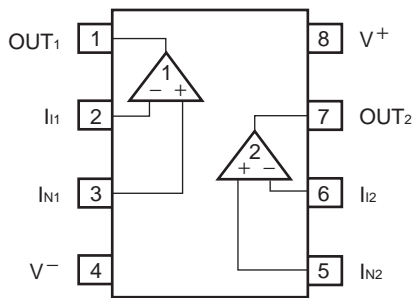

**ABSOLUTE MAXIMUM RATINGS (T<sub>A</sub> = 25°C, unless otherwise specified)**

Parameter	Symbol	Ratings	Unit
Voltage between V <sup>+</sup> and V <sup>-</sup> <sup>Note1</sup>	V <sup>+</sup> - V <sup>-</sup>	-0.3 to +36	V
Differential Input Voltage	V <sub>ID</sub>	±30	V
Input Voltage <sup>Note2</sup>	V <sub>I</sub>	V <sup>-</sup> -0.3 to V <sup>+</sup> +0.3	V
Output applied Voltage <sup>Note3</sup>	V <sub>O</sub>	V <sup>-</sup> -0.3 to V <sup>+</sup> +0.3	V
Total Power Dissipation	P <sub>T</sub>	350 <sup>Note4</sup>	mW
Output Short Circuit Duration <sup>Note5</sup>		Indefinite	s
Operating Ambient Temperature	T <sub>A</sub>	-40 to +85	°C
Storage Temperature	T <sub>stg</sub>	-55 to +125	°C

- Notes**
- Note that reverse connections of the power supply may damage ICs.
  - The input voltage should be allowed to input without damage or destruction. Even during the transition period of supply voltage, power on/off etc., this specification should be kept. The normal operation will establish when the both inputs are within the Common Mode Input Voltage Range of electrical characteristics.
  - This specification is the voltage which should be allowed to supply to the output terminal from external without damage or destructive. Even during the transition period of supply voltage, power on/off etc., this specification should be kept. The output voltage of normal operation will be the Output Voltage Swing of electrical characteristics.
  - This is the value when T<sub>A</sub> ≤ 59°C during loading a glass epoxy substrate (size: 100 mm x 100 mm, thickness: 1 mm, filling wiring of 15% of the substrate only on the one side of copper foil). When T<sub>A</sub> > 59°C, conduct a derating in -5.4 mW/°C. The heat resistance between a junction and ambient air under the same condition is R<sub>th(J-A)</sub> = 187°C/W.
  - Pay careful attention to the total power dissipation not to exceed the absolute maximum ratings, Note 4.

**Caution** Product quality may suffer if the absolute maximum rating is exceeded even momentarily for any parameter. That is, the absolute maximum ratings are rated values at which the product is on the verge of suffering physical damage, and therefore the product must be used under conditions that ensure that the absolute maximum ratings are not exceeded.

**RECOMMENDED OPERATING CONDITIONS**

Parameter	Symbol	MIN.	TYP.	MAX.	Unit
Supply Voltage (Split)	V <sup>±</sup>	±5		±16	V
Output Current	I <sub>o</sub>			±6	mA
Capacitive Load (A <sub>v</sub> = +1)	C <sub>L</sub>			4000 <sup>Note</sup>	pF

**Note** This is the value during a feedback resistance (R<sub>f</sub> = 0 Ω). Since it is prone to oscillate when the value of R<sub>f</sub> is large, a capacitor of about 100 pF should be connected in parallel with R<sub>f</sub>.

**ELECTRICAL CHARACTERISTICS (T<sub>A</sub> = 25°C, V<sup>±</sup> = ±15 V, unless otherwise specified)**

Parameter	Symbol	Conditions	MIN.	TYP.	MAX.	Unit
Input Offset Voltage	V <sub>IO</sub>	R <sub>S</sub> ≤ 50 Ω		±1.5	±3	mV
Input Offset Current	I <sub>IO</sub>			±25	±100	pA
Input Bias Current <sup>Note1</sup>	I <sub>B</sub>			50	200	pA
Large Signal Voltage Gain	A <sub>V</sub>	R <sub>L</sub> ≥ 2 kΩ, V <sub>O</sub> = ±10 V	25000	200000		dB
Circuit Current <sup>Note2</sup>	I <sub>CC</sub>	I <sub>O</sub> = 0 A		1.4	2.2	mA
Common Mode Rejection Ratio	CMR		70	80		dB
Source Variation Rejection Ratio	SVR		70	85		dB
Output Voltage Swing	V <sub>Om</sub>	R <sub>L</sub> ≥ 10 kΩ	±12	+14.0 -13.3		V <sub>P-P</sub>
		R <sub>L</sub> ≥ 2 kΩ	±10	+13.5 -12.8		V <sub>P-P</sub>
Common Mode Input Voltage Range	V <sub>ICM</sub>		+11.7 -11.0	+15 -12		V
Slew Rate	SR	A <sub>V</sub> = +1		5.5		V/μs
Unity Gain Frequency	f <sub>unity</sub>			2.8		MHz
Input Equivalent Noise Voltage Density	e <sub>n</sub>	R <sub>S</sub> = 100 Ω, f = 1 kHz		25		nV/√Hz
Channel Separation				120		dB
Temperature Coefficient of Input Offset Voltage	ΔV <sub>IO</sub> /ΔT	T <sub>A</sub> = -20 to +70°C		±7		μV/°C

**Notes 1.** Input bias currents flow into IC, because each currents are base current to Pch J-FET on input stage.

When T<sub>J</sub> = 25°C or more, this figure exponentially grows along with a rise of temperature.

**2.** This current flows irrespective of the existence of use.

**Caution** Special attention is required for insulation between pins on a board, since the μPC835 has a high-input impedance characteristic.

**TYPICAL PERFORMANCE CHARACTERISTICS ( $T_A = 25^\circ\text{C}$ , unless otherwise specified)  
(Reference value)**

$P_T$  vs.  $T_A$  (ABSOLUTE MAXIMUM RATING)

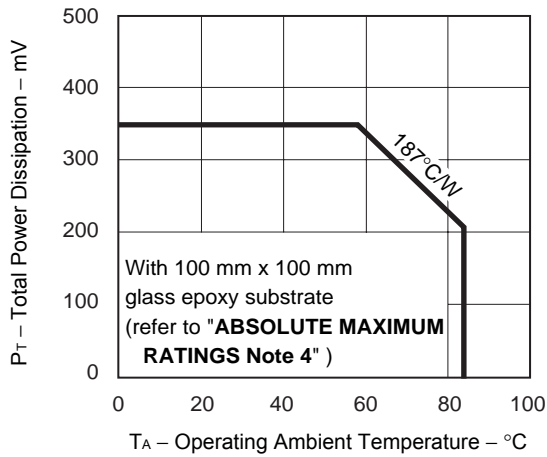

$A_v, \phi$  vs.  $f$

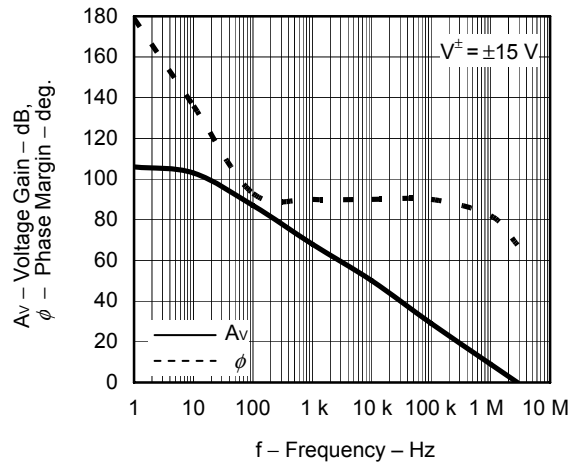

$V_{IO}$  vs.  $T_A$

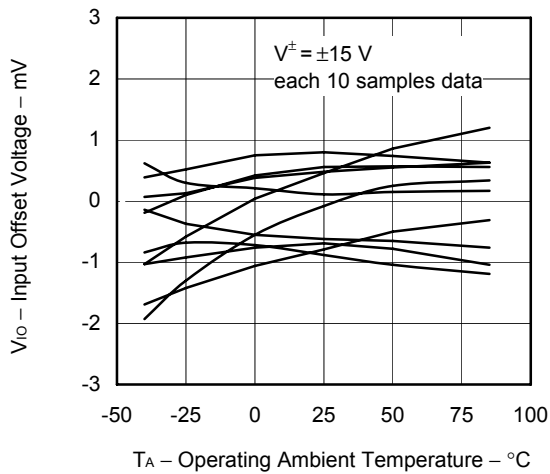

$V_{Om}$  vs.  $f$

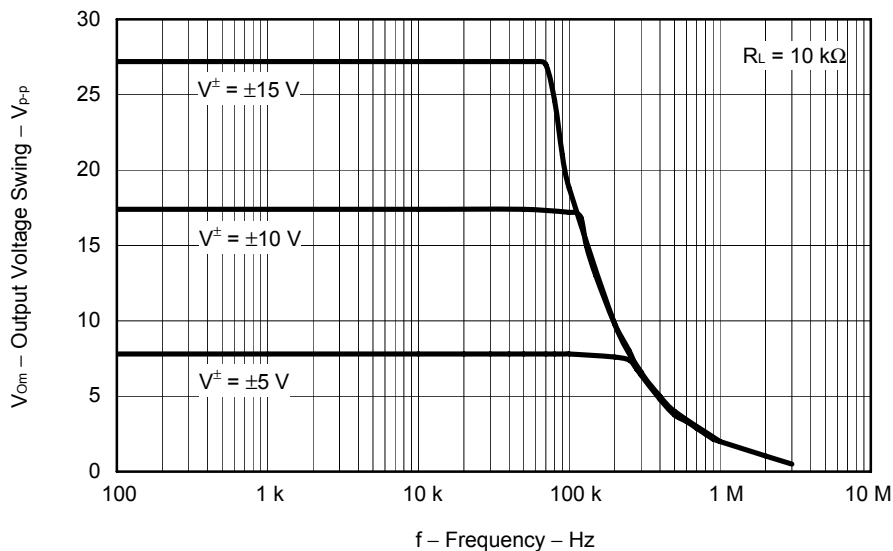

$I_B$  vs.  $T_A$

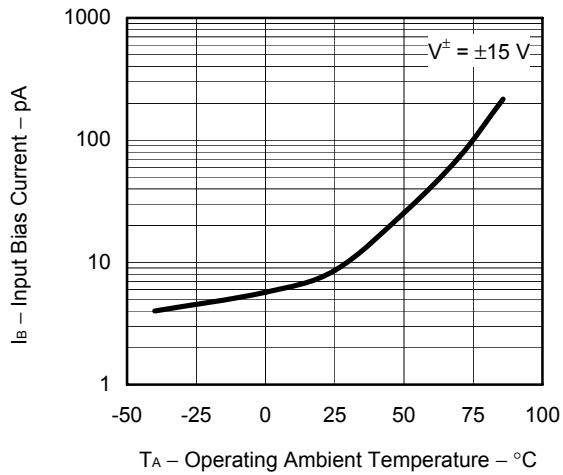

$V_{om}$  vs.  $V^\pm$

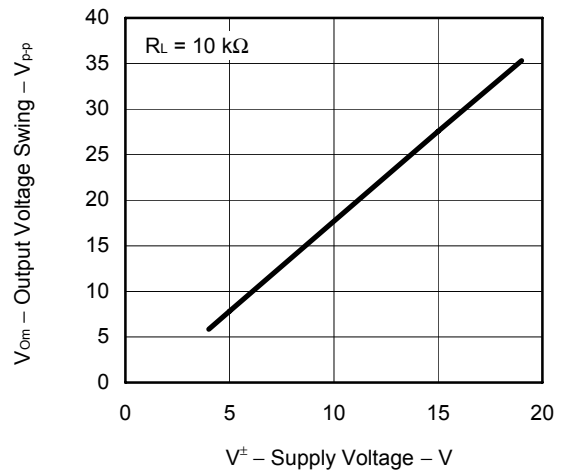

$V_{o^+}$  vs.  $I_{o(SOURCE)}$

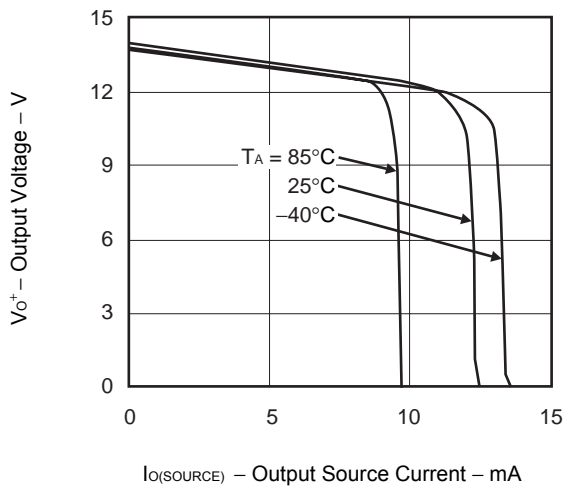

$V_{o^-}$  vs.  $I_{o(SINK)}$

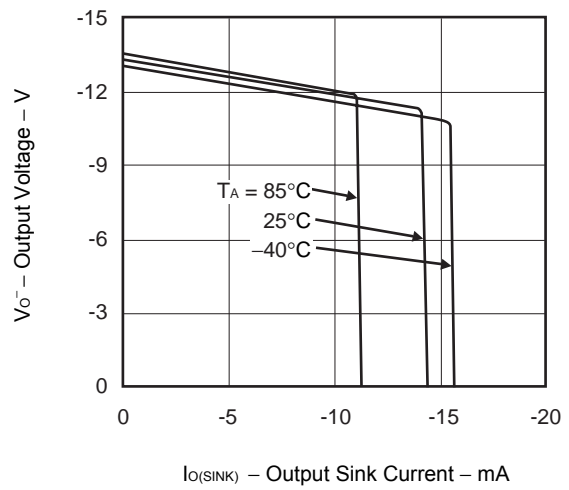

$I_{cc}$  vs.  $T_A$

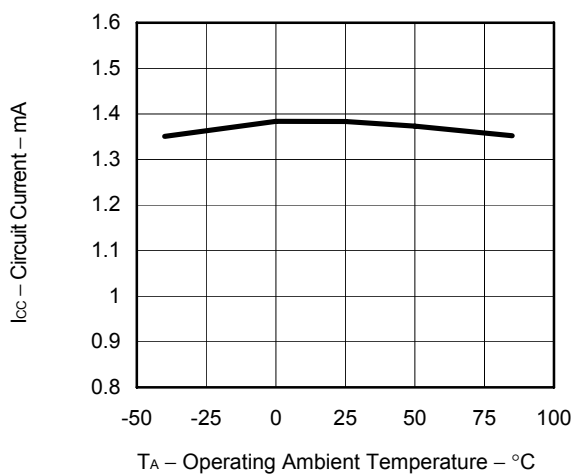

$e_n$  vs.  $f$

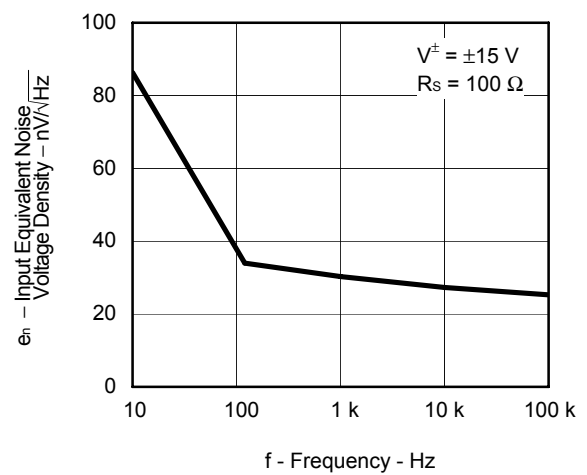



PULSE RESPONSE I  
( $V^{\pm} = \pm 15$  V,  $A_v = +1$ ,  $R_L = 2$  k $\Omega$ ,  $C_L = 100$  pF)

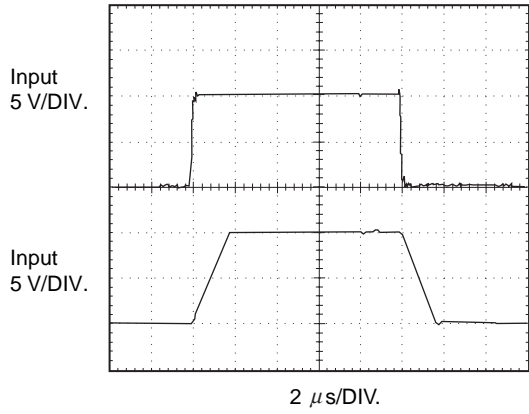

PULSE RESPONSE II  
( $V^{\pm} = \pm 15$  V,  $A_v = +1$ ,  $R_L = 2$  k $\Omega$ ,  $C_L = 4000$  pF)

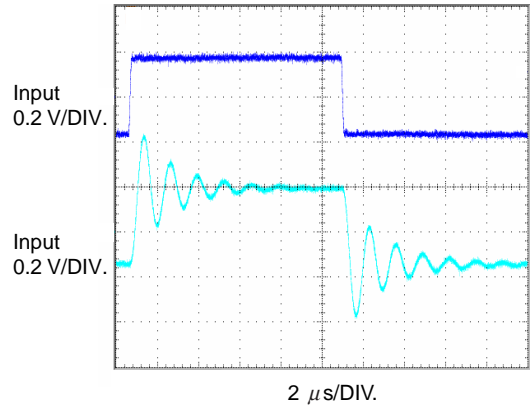

**PRECAUTIONS FOR USE**

**O The process of unused circuits**

If there is an unused circuit, the following connection is recommended.

**Process example of unused circuits**

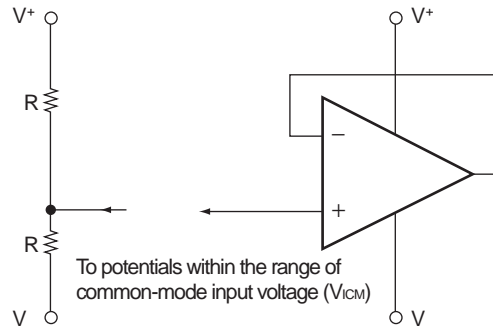

**O Power supply to be used (single/dual)**

Operational amplifiers operate when a given voltage is applied to between V+ and V-. Therefore, they can operate with a single power supply (V- = GND). However, since input/output around the GND is impossible with the single power supply, it is required to pay attention to the common-mode input voltage range and the maximum output voltage when using them.

**O Ratings of input/output pin voltage**

When the voltage of input/output pin exceeds the absolute maximum rating, it may cause degradation of characteristics or damages, by a conduction of a parasitic diode within an IC. In addition, when the input pin may be lower than V-, or the output pin may exceed the supply voltage, it is recommended to make a clamp circuit by a diode whose forward voltage is low (e.g.: Schottky diode) for protection.

**O Range of common-mode input voltage**

When the supply voltage does not meet the condition of electrical characteristics, the range of common-mode input voltage is as follows.

$V_{ICM}$  (TYP.):  $V^- + 3$  to  $V^+$  (V) ( $T_A = 25^\circ\text{C}$ )

During designing, consider variations in characteristics and temperature characteristics for use with allowance.

**O The maximum output voltage**

The range of the TYP. value of the maximum output voltage when the supply voltage does not meet the condition of electrical characteristics is as follows:

$V_{Om^+}$  (TYP.):  $V^+ - 1$  (V) ( $T_A = 25^\circ\text{C}$ ,  $R_L \geq 10\text{ k}\Omega$ ),  $V_{Om^-}$  (TYP.):  $V^- + 1.7$  (V) ( $T_A = 25^\circ\text{C}$ ,  $R_L \geq 10\text{ k}\Omega$ )

During designing, consider variations in characteristics and temperature characteristics for use with allowance.

In addition, note that the output voltage range ( $V_{Om^+} - V_{Om^-}$ ) becomes narrow when an the output current increases.

**O Handling of ICs**

When stress is added to ICs due to warpage or bending of a board, the characteristic fluctuates due to piezoelectric effect. Therefore, pay attention to warpage or bending of a board.

PACKAGE DRAWING (Unit : mm)

8-PIN PLASTIC TSSOP (3x3)

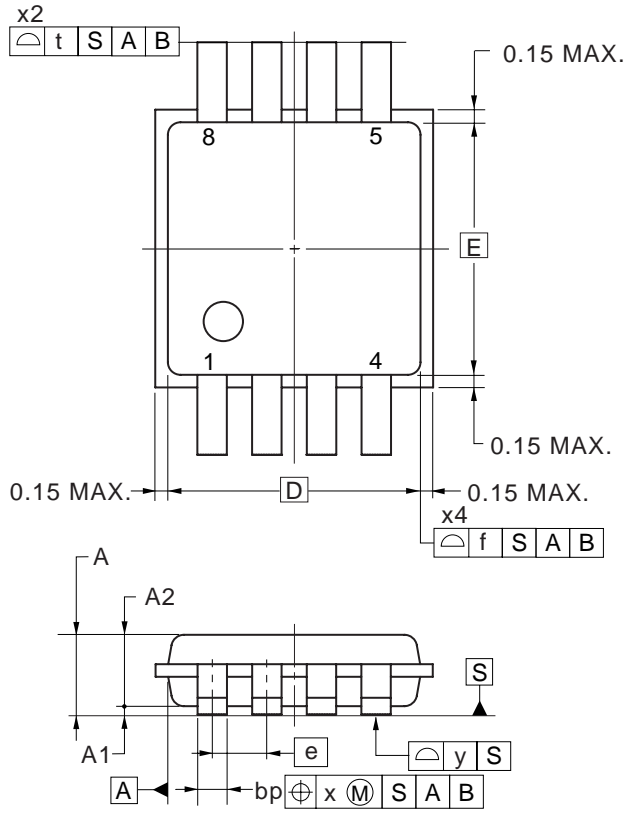

detail of lead end

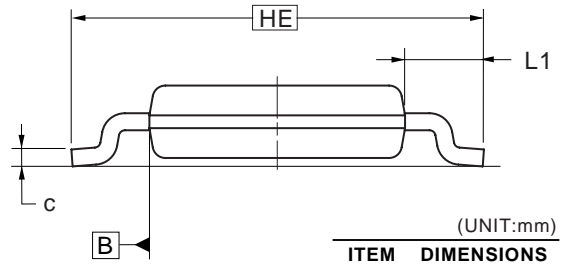
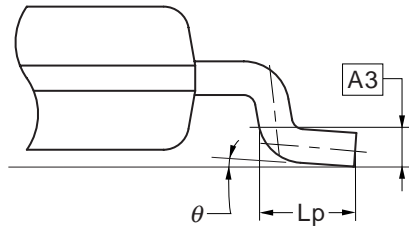

(UNIT:mm)

ITEM	DIMENSIONS
$D$	3.00
$E$	3.00
$f$	0.20
$HE$	4.90
$t$	0.20
$e$	0.65
$bp$	0.25 to 0.38
$A1$	$0.10 \pm 0.05$
$A$	1.10 MAX.
$A2$	$0.85 \pm 0.10$
$A3$	0.25
$L1$	0.95
$c$	0.13 to 0.23
$Lp$	$0.55 \pm 0.15$
$x$	0.10
$y$	0.10
$\theta$	$3^{\circ} +5^{\circ}$ $-3^{\circ}$

P8MN-65-KAA

© NEC Electronics Corporation 2006

**RECOMMENDED SOLDERING CONDITIONS**

The μPC835 should be soldered and mounted under the following recommended conditions.

For soldering methods and conditions other than those recommended below, contact an NEC Electronics sales representative.

For technical information, see the following website.

**Semiconductor Device Mount Manual (<http://www.necel.com/pkg/en/mount/index.html>)**

**Type of Surface Mount Device**

μPC835MN-KAA-E1-AT <sup>Note1</sup>: 8-pin plastic TSSOP (3 x 3)

μPC835MN-KAA-E2-AT <sup>Note1</sup>: 8-pin plastic TSSOP (3 x 3)

Process	Conditions	Symbol
Infrared reflow	Maximum temperature (package's surface temperature): 260°C or below, Time at maximum temperature: 10 seconds or less, Time at temperature higher than 220°C: 60 seconds or less, Preheating time at 160°C to 180°C: 60 to 120 seconds, Times: Three times, Exposure limit: 7 days <sup>Note2</sup> (after that, prebake at 125°C for 10 hours), Flux: Rosin flux with low chlorine (0.2 Wt% or below) recommended.	IR60-107-3
Wave Soldering	Maximum temperature: 260°C (molten solder temperature), Flow soldering time: 10 seconds or less, Preheating conditions: 120°C or below (package surface temperature) No time limit, Times: Once, Exposure limit: 7 days <sup>Note2</sup> (after that, prebake at 125°C for 10 hours).	WS60-107-1
Partial Heating Method	Pin temperature: 350°C or below, Heat time: 3 seconds or less (Per each side of the device), Flux: Rosin flux with low chlorine (0.2 Wt% or below) recommended.	P350

**Notes 1.** Pb-free (This product does not contain Pb in external electrode and other parts.)

**2.** After opening the dry pack, store it a 25°C or less and 65% RH or less for the allowable storage period.

**Caution** Apply only one kind of soldering condition to a device, except for "partial heating method", or the device will be damaged by heat stress.

- **The information in this document is current as of March, 2007. The information is subject to change without notice. For actual design-in, refer to the latest publications of NEC Electronics data sheets or data books, etc., for the most up-to-date specifications of NEC Electronics products. Not all products and/or types are available in every country. Please check with an NEC Electronics sales representative for availability and additional information.**
- No part of this document may be copied or reproduced in any form or by any means without the prior written consent of NEC Electronics. NEC Electronics assumes no responsibility for any errors that may appear in this document.
- NEC Electronics does not assume any liability for infringement of patents, copyrights or other intellectual property rights of third parties by or arising from the use of NEC Electronics products listed in this document or any other liability arising from the use of such products. No license, express, implied or otherwise, is granted under any patents, copyrights or other intellectual property rights of NEC Electronics or others.
- Descriptions of circuits, software and other related information in this document are provided for illustrative purposes in semiconductor product operation and application examples. The incorporation of these circuits, software and information in the design of a customer's equipment shall be done under the full responsibility of the customer. NEC Electronics assumes no responsibility for any losses incurred by customers or third parties arising from the use of these circuits, software and information.
- While NEC Electronics endeavors to enhance the quality, reliability and safety of NEC Electronics products, customers agree and acknowledge that the possibility of defects thereof cannot be eliminated entirely. To minimize risks of damage to property or injury (including death) to persons arising from defects in NEC Electronics products, customers must incorporate sufficient safety measures in their design, such as redundancy, fire-containment and anti-failure features.
- NEC Electronics products are classified into the following three quality grades: "Standard", "Special" and "Specific".

The "Specific" quality grade applies only to NEC Electronics products developed based on a customer-designated "quality assurance program" for a specific application. The recommended applications of an NEC Electronics product depend on its quality grade, as indicated below. Customers must check the quality grade of each NEC Electronics product before using it in a particular application.

"Standard": Computers, office equipment, communications equipment, test and measurement equipment, audio and visual equipment, home electronic appliances, machine tools, personal electronic equipment and industrial robots.

"Special": Transportation equipment (automobiles, trains, ships, etc.), traffic control systems, anti-disaster systems, anti-crime systems, safety equipment and medical equipment (not specifically designed for life support).

"Specific": Aircraft, aerospace equipment, submersible repeaters, nuclear reactor control systems, life support systems and medical equipment for life support, etc.

The quality grade of NEC Electronics products is "Standard" unless otherwise expressly specified in NEC Electronics data sheets or data books, etc. If customers wish to use NEC Electronics products in applications not intended by NEC Electronics, they must contact an NEC Electronics sales representative in advance to determine NEC Electronics' willingness to support a given application.

(Note)

- (1) "NEC Electronics" as used in this statement means NEC Electronics Corporation and also includes its majority-owned subsidiaries.
- (2) "NEC Electronics products" means any product developed or manufactured by or for NEC Electronics (as defined above).

## X-ON Electronics

Largest Supplier of Electrical and Electronic Components

*Click to view similar products for [Operational Amplifiers - Op Amps](#) category:*

*Click to view products by [Renesas](#) manufacturer:*

Other Similar products are found below :

[NCV33072ADR2G](#) [LM258AYDT](#) [LM358SNG](#) [430227FB](#) [LT1678IS8](#) [042225DB](#) [058184EB](#) [UPC822G2-A](#) [NCV33202DMR2G](#) [NTE925](#)  
[AZV358MTR-G1](#) [AP4310AUMTR-AG1](#) [HA1630D02MMEL-E](#) [HA1630S01LPEL-E](#) [SCY33178DR2G](#) [NJU77806F3-TE1](#)  
[NCV5652MUTWG](#) [NCV20034DR2G](#) [LM324EDR2G](#) [LM2902EDR2G](#) [NTE7155](#) [NTE778S](#) [NTE871](#) [NTE924](#) [NTE937](#) [MCP6V17T-](#)  
[E/MNY](#) [MCP6V19-E/ST](#) [MXD8011HF](#) [MCP6V17T-E/MS](#) [SCY6358ADR2G](#) [ADA4523-1BCPZ](#) [LTC2065HUD#PBF](#) [ADA4523-1BCPZ-](#)  
[RL7](#) [2SD965T-R](#) [RS6332PXK](#) [BDM8551](#) [BDM321](#) [MD1324](#) [COS8052SR](#) [COS8552SR](#) [COS8554SR](#) [COS2177SR](#) [COS2353SR](#)  
[COS724TR](#) [LM2902M/TR](#) [ASOPD4580S-R](#) [RS321BKXF](#) [ADA4097-1HUIZ-RL7](#) [NCS20282FCTTAG](#) [NCV4333DTBR2G](#)