

Bestsellers for Construction and Industry

Quality Tools

ex stock KNIPEX



2023/24

RENNSTEIG – Company

Rennsteig Werkzeuge GmbH is a traditional German company based in southern Thuringia.

Since 1991, RENNSTEIG has been an independent subsidiary of the prestigious KNIPEX-Werk C. Gustav Putsch KG in Wuppertal.

A wide variety of high-quality tools are manufactured at two facilities in Steinbach-Hallenberg.

The company currently employs a team of around 380 people. It has a very high level of vertical integration and processes over 2000 tonnes of mostly high-alloy tool steels every year.

Modern industrial production processes enable consistent product quality at the highest level.



RENNSTEIG – Tool solutions

Some RENNSTEIG products are ideal for professionals to use in conjunction with KNIPEX products.

This catalogue offers KNIPEX customers the opportunity to check out this product range for themselves. These are a selection of best-selling RENNSTEIG products that can be easily ordered using the KNIPEX supplier number and warehouse.

In the likelihood of using a wider product assortment, it is also possible to access the full RENNSTEIG range.

Orders can then also be placed directly with Rennsteig Werkzeuge GmbH:

www.rennsteig.com

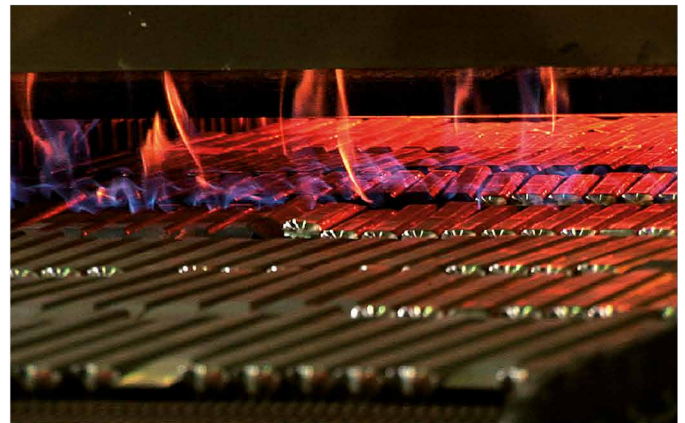



Contents

Striking tools	6
<hr/>	
Chisels	18
<hr/>	
Shank chisels	28
<hr/>	
Wrecking Bar	32
<hr/>	
Disassembly tools	34
<hr/>	
Punching tools	36
<hr/>	
Scrapers	38
<hr/>	
Index Article Number	39
<hr/>	

Gross price list,
plus VAT at the rate ruling at time of supply.
Price per piece. The price list is valid until 31.03.2024.

It is not permissible to copy the catalogue or parts of it in any way without our approval.
Subject to model modifications and technical changes. Illustrations, dimensions and weights are just approximate.
No liability is assumed for misprints or errors.

Striking tools

Precise centre-punching with adjustable striking force



Art. No. 9R 430 231 / 430 230 / 430 229



2-components-handguard



Adjustable striking force



Replaceable, hardened pin

Automatic Centre Punch

- For preparing and precisely marking a drill point to prevent the drill tip from drifting
- Triggered automatically by a special spring mechanism
- Versatile tool even in confined spaces, since no hammering is required
- Available in 3 different sizes, with a striking force that is adjustable from 20 to 250 N
- Version with 2-component grips or knurled gripping surface
- Made of special tool steel, galvanised surface
- Supplied with euro slot hanger for presentation on self-service displays



YouTube



Art. No. 9R 430 230



Art. No. 9R 430 130

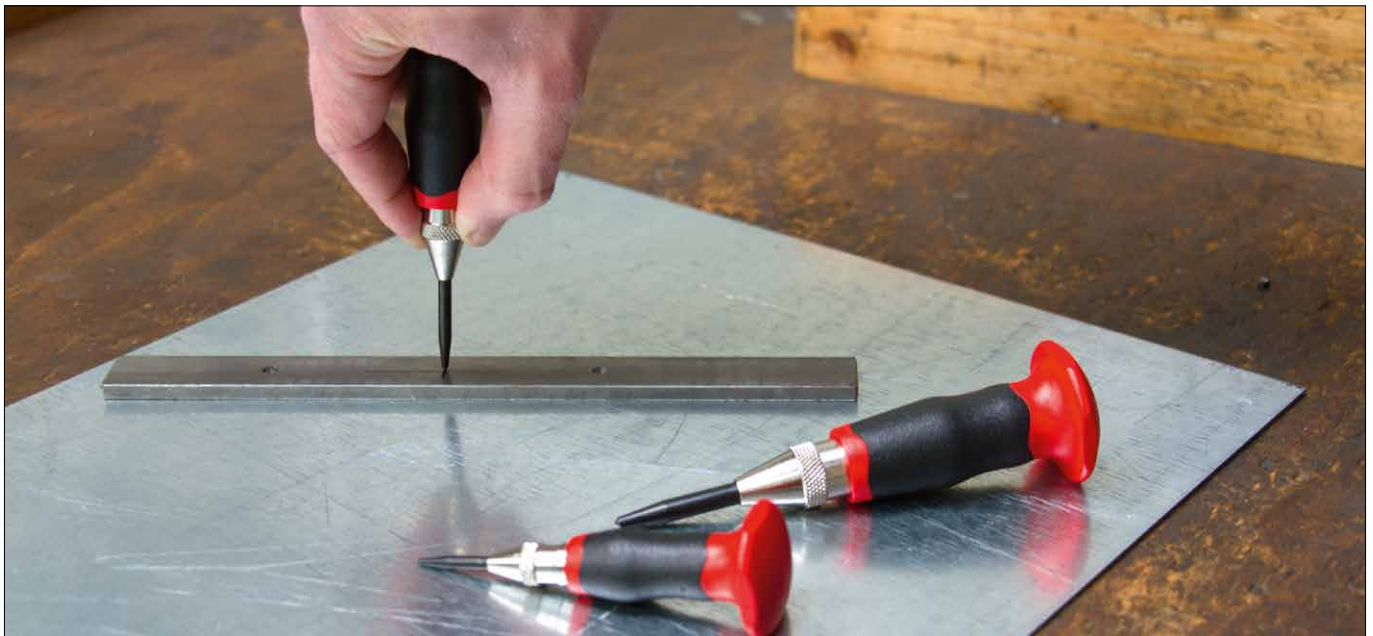

The punch's striking force increases with its size. We therefore recommend to select the size according to the given application for dot marking on steel, NF metals and plastics until robust marking of tool and structural steel.

Art. No.	EAN 4049002	Handguard	Shank Ø mm	Tip Ø mm	Adjustable striking force N min	Adjustable striking force N max	↔ mm	⚖ g	📦	Price €
Automatic Centre Punches										
9R 430 129	024122		11	3.5	20	50	95	45	1	22,35
9R 430 229	096914	•	11	3.5	20	50	95	65	1	22,35
9R 430 130	002380		14	4	60	130	125	78	1	25,40
9R 430 230	096921	•	14	4	60	130	125	97	1	25,40
9R 430 131	024146		17	6	180	250	130	127	1	28,15
9R 430 231	096938	•	17	6	180	250	130	155	1	28,15
Spare tips										
9R 439 129	024139			3.5			35	4	1	3,90
9R 439 130	013034			4			46	5	1	5,40
9R 439 131	024153			6			54	12	1	6,55

Striking tools

Set of adjustable centering punches

- For precise transfer of bore holes to other workpieces
- Working principle ensures precise, offset-free and absolutely centred punching on workpieces
- Uniform alignment of the slotted centring sleeve on the sample workpiece or in a drilling template via a knurled screw
- Specially hardened and tempered, continuous centre punch pins - can be reground repeatedly
- Replacement pins available for worn punch tips
- Made of special tool steel
- Complete set of centring punches in 3 sizes
- For bore hole diameters from 6 - 16 mm
- Packed in practical moulded foam



Art. No. 9R 430 143



1. Insert centering punch of appropriate size into bore hole, turn the knurled screw

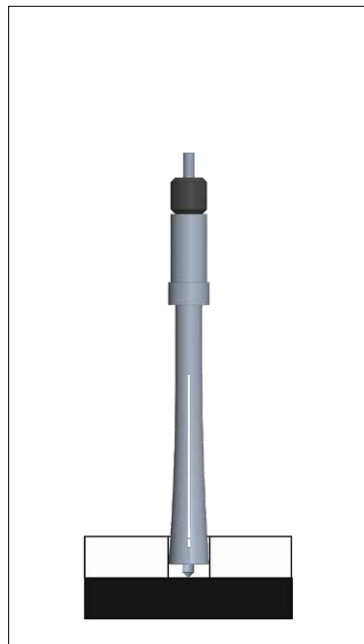

2. Expand the centre punch until the centring sleeve fits the bore hole

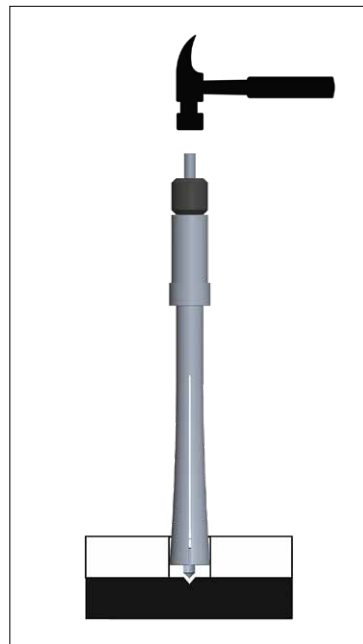

3: Hit the centering punch with a hammer - indentation for drill guide is set exactly centered

Art. No.	EAN	Finish	Color	↔ mm	⚖ g	📦	Price €
9R 430 143	023880	Adjustable Centering Punches, 3 piece set, in clear plastic case			151	1	157,25

Info

Transferring bore holes to other workpieces with precision is a complicated step. Centring punches with a simple working principle provide the best way of carrying out this task professionally.



Centre Punch

- For precise marking of a drill point and for guiding the drill tip to prevent it from drifting
- Made of high-alloy tool steel
- Hardened throughout for maximum conveyance of striking force
- Special safety impact head prevents mushrooming and material splitting
- Tip ground and polished
- Requirements of current standards (e.g. DIN) are met or exceeded
- All tools are GS-approved
- Golden dip-coated

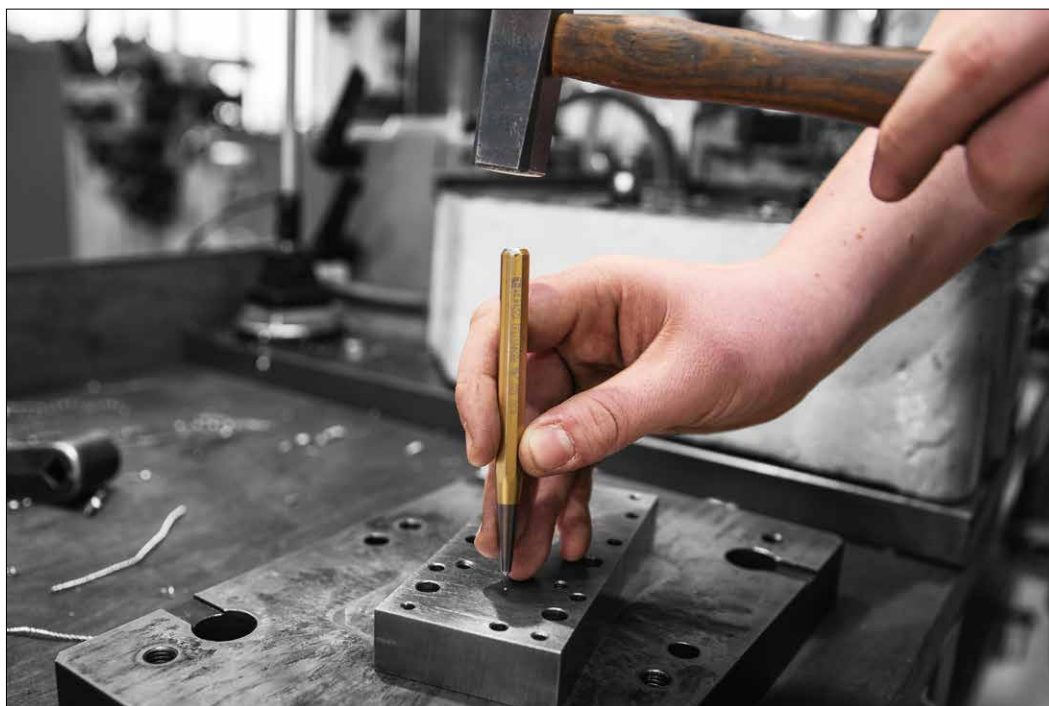

Art. No. 9R 431 120 0



Art. No.	EAN 4049002	Handguard	Tip Ø mm	 mm	Color	↔ mm	 g		Price €
Centre Punch									
9R 430 100 0	002366		3	8	gold	100	35	10	1,95
9R 430 120 0	002373		4	10	gold	120	65	10	2,20
9R 431 120 0	002397		5	10	gold	120	66	10	2,20
9R 432 120 0	002403		5	12	gold	120	94	10	2,50
9R 433 150 0	002410		5	12	gold	150	118	10	3,45
9R 434 150 0	013072		6	14	gold	150	161	10	4,45
Centre Punches with Euro Holder									
9R 430 100 0 SB	012365		3	8	gold	100	45	10	2,45
9R 430 120 0 SB	012372		4	10	gold	120	75	10	2,70

Striking tools

Safe disassembly with top precision



Art. No. 9R 425 530 6 RC



All edges of the pin punch are rounded



High-polished finish



Quality under the surface: Tempered safety striking head

High-quality surface of RENNSTEIG pin punches

- Ground and polished surface finish
- Much less surface roughness than competitors (see roughness profiles)
- Advantages of this surface treatment:
 - Parallel pin punch is less prone to corrosion
 - Less likely to pinch during use
 - Higher bending resilience (longer service life and higher elasticity)
 - Any surface nicks from forging are ground out, thus practically eliminating fracture points
 - Rounded edges
 - Splitting and burring at the tip are prevented
 - Reduced risk of injury to the user
 - No damage to the workpiece

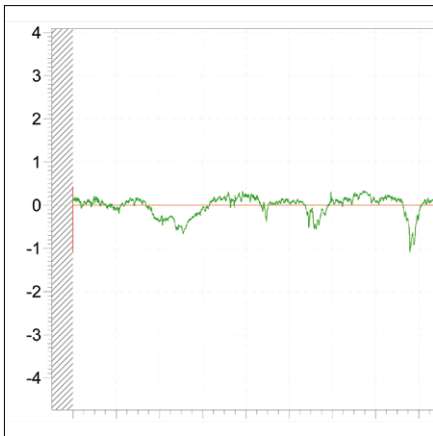

RENNSTEIG parallel pin punch
Ra: 0.15 μm , Rz: 0.92 μm



RENNSTEIG quality up close

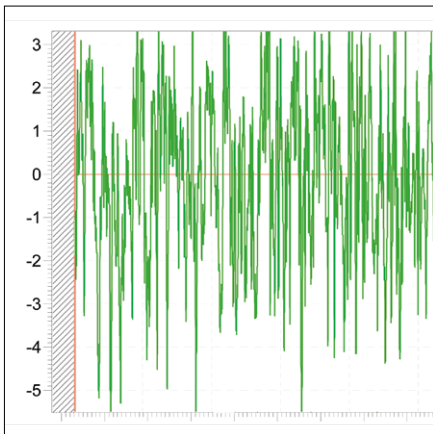

Comparable competitor pin punch
Ra: 1,53 μm , Rz : 11,13 μm

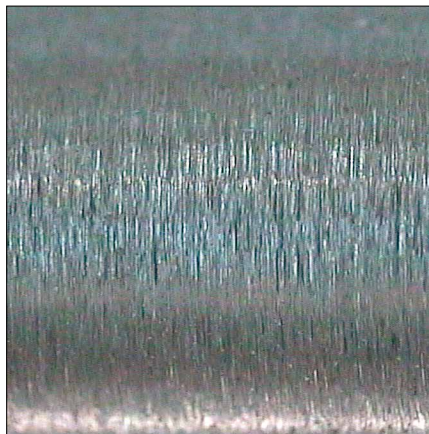

Comparable competitor up close

Info

Ra Mean roughness value, the arithmetic mean of all roughness profile values
Rz Individual roughness depth, the arithmetic mean of individual roughness depth of consecutive measurement samples. The individual roughness depths are the sum of the height of the highest profile peak and deepest profile valley within a measurement sample.



Striking tools

Parallel Pin Punches

- For driving out or removing bolts, rivets, cotter pins or other fasteners from through-holes
- Alternatively for accurately countersinking the above-mentioned fasteners into the workpiece surface
- High-alloy tool steel, hardened throughout for optimum transmission of force
- Special safety impact head prevents mushrooming and material splitting
- Polished using an optimised process - no chrome is needed
- Golden dip-coated
- Rounded edges prevent damage to the workpiece
- Requirements of current standards (e.g. DIN) are met or exceeded
- All tools are GS-approved









Art. No. 9R 450 005 0

Art. No.	EAN 4049002	Handguard	Tip Ø mm	 mm	Color	↔ mm	 g		Price €
9R 450 002 0	002786		2	10	gold	150	62	10	3,50
9R 450 003 0	002809		3	10	gold	150	59	10	3,50
9R 450 004 0	002823		4	10	gold	150	62	10	3,65
9R 450 005 0	002847		5	10	gold	150	65	10	3,65
9R 450 006 0	002854		6	10	gold	150	69	10	3,65
9R 450 008 0	002878		8	12	gold	150	106	10	4,30
9R 450 010 0	002885		10	12	gold	150	119	10	4,30
9R 450 025 0	002793		2.5	10	gold	150	63	10	3,50
9R 451 012 0	021053		12	14	gold	150	164	10	5,50

Sets of Parallel Pin Punches

- Sets without handguard, 6-piece, each with Ø 3 mm/4 mm/5 mm/6 mm/8 mm/10 mm
- Set with handguard, 5-piece, with Ø 2 mm/3 mm/4 mm/5 mm/6 mm
- Parallel pin punch gold dip-coated
- Parallel pin punch set „Exclusive“, multi-coloured, powder-coated
- Parallel pin punch „Exclusive“ made of high-alloy tool steel, hardened and tempered throughout, hardness ≥ 58 HRC
- Polished using an optimised process - no chrome is needed
- Requirements of current standards (e.g. DIN) are met or exceeded

Art. No.	EAN 4049002	Illustration	Finish	Color	↔ mm	 g		Price €
9R 425 152 0	028960		“Standard” pin punch set with handguard, in plastic case, 5-piece	gold		568	1	37,55
9R 425 160 0	002243		“Standard” pin punch set, in metal case, 6-piece	gold		740	1	31,45

Art. No.	EAN 4049002	Illustration	Finish	Color	↔ mm	⚖ g	📦	Price €
9R 425 170 0	002250		"Standard" pin punch set, in plastic stand, 6-piece	gold		520	1	23,95
9R 425 530 6 RC	086762		"Exclusive" pin punch set, in metal case, 6-piece	multicoloured		740	1	47,80

Parallel Pin Punches with guide sleeve

- Made of high-alloy tool steel
- Guide sleeve zinc-chromated and knurled
- Hardened punch pin
- Parallel pin punches Ø 0.9 to 3.9 mm with loose guide sleeve
- Parallel pin punch Ø 5.9 mm with fixed sleeve



Art. No. 9R 457 100 5



Sliding sleeve

Art. No.	EAN 4049002	Finish	Color	↔ mm	⚖ g	📦	Price €
9R 457 100 5	022784	Set of Parallel Pin Punches with guide sleeve, in metal case, 8-piece			375	1	55,65

Striking tools

Parallel Pin Punches XXL

- For driving out or removing bolts, rivets, cotter pins or other fasteners from through-holes
- Alternatively for accurately countersinking the above-mentioned fasteners into the workpiece surface
- High-alloy tool steel, hardened throughout for optimum transmission of force
- Special safety impact head prevents mushrooming and material splitting
- Includes working tips Ø 8 mm/10 mm/12 mm/14 mm/16 mm (length 225 - 290 mm)
- Golden dip-coated
- with ergonomic 2C handguard
- Requirements of current standards (e.g. DIN) are met or exceeded
- All metal parts are GS-approved



Art. No. 9R 425 154 0



Art. No.	EAN 4049002	Contents	↔ mm	⚖ g	📦	Price €
9R 425 154 0	091544	451 308 0 Parallel Pin Punches XXL 451 310 0 Parallel Pin Punches XXL 451 312 0 Parallel Pin Punches XXL 451 314 0 Parallel Pin Punches XXL 451 316 0 Parallel Pin Punches XXL		2,520	1	107,05



Taper Punches

- Made of high-alloy tool steel
- Hardened throughout for maximum conveyance of striking force
- Special safety impact head prevents mushrooming and material splitting
- Polished surface finish
- Rounded edges
- Golden dip-coated
- Requirements of current standards (e.g. DIN) are met or exceeded
- All tools are GS-approved

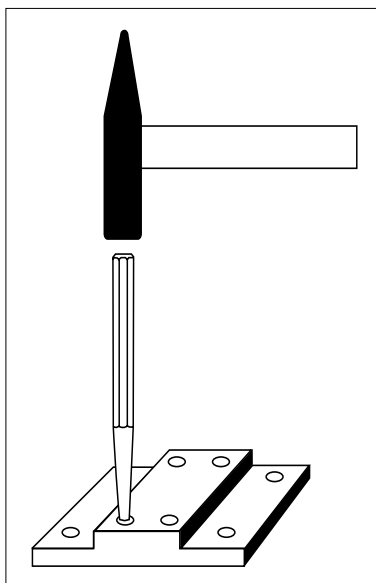

Art. No. 9R 440 003 0



Art. No.	EAN 4049002	Handguard	Tip Ø mm	 mm	↔ mm	 g		Price €
Type B per DIN 6458								
9R 440 002 0	002434		2	10	120	62	10	2,30
9R 440 003 0	002441		3	10	120	64	10	2,30
9R 440 004 0	002458		4	10	120	66	10	2,30
9R 440 005 0	002465		5	10	120	68	10	2,30

Striking tools

Sets of Taper Punches

- Taper punch sets equipped with \varnothing 1 mm/2 mm/3 mm/4 mm/5 mm and centre punch \varnothing 4 mm
- Requirements of current standards (e.g. DIN) are met or exceeded
- All tools are GS-approved



Art. No.	EAN 4049002	Illustration	Finish	Color	↔ mm	⚖ g	📦	Price €
9R 424 120 0	002205		Taper Punch Set, in plastic stand	gold		459	1	14,95
9R 424 130 0	002212		Taper Punch Set, in metal case	gold		657	1	21,90

Impact Nail Set

- Knocks impact nails for conduit fixing clips or bands directly into concrete (without pre-drilling)
- Made of high-alloy tool steel
- Hardened throughout for maximum conveyance of striking force
- Special safety impact head prevents mushrooming and material splitting
- Versions with and without fixation of the nails
- With tool 9R 455 170 5, the nails are held by a special spring
- Tool 9R 445 136 5 has an integrated slot for removing splinters or passing through fastening loops



Art. No. 9R 455 170 5



Art. No. 9R 445 135 5



Art. No. 9R 445 136 5

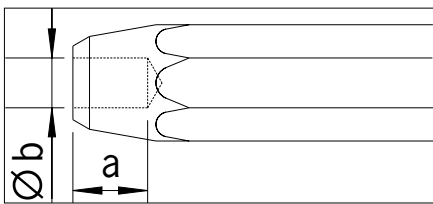

Art. No.	EAN 4049002	Handguard	Hole depth a mm	Hole dia. Ø b mm	mm	↔ mm	⚖ g	📦	Price €
9R 445 135 5	029004		9	6	14	135	165	10	5,45
9R 445 136 5	029011		12	6	14	135	156	10	7,15
9R 455 170 5	025303	•	13	4.3	18	170	400	5	19,95

Chisels

The right chisel for any application



Conical edge prevents binding, painted blade, ground edge



Quality painted finish with laser marking



Quality under the surface: Tempered safety striking head

Mason's Chisels, octagonal

- Mainly used in the construction industry
- Profile material: Octagonal shank
- Made of high-alloy tool steel
- Hardened throughout for maximum conveyance of the striking force, allows repeated regrinding of the working tip
- Special safety impact head prevents mushrooming and material splitting
- Golden dip-coated
- Requirements of current standards (e.g. DIN) are met or exceeded
- All tools are GS-approved







Art. No. 9R 351 300 1



Art. No. 9R 350 300 1



Art. No.	EAN 4049002	Handguard	Finish	 mm	 mm	 mm	 g		Price €
9R 350 200 1	001352		painted	23	16	200	302	10	6,65
9R 350 250 1	001376		painted	23	16	250	392	10	8,00
9R 350 300 19	024092		painted	26	16	300	460	5	9,95
9R 351 300 19	026850	•	painted	26	16	300	607	10	14,85
9R 351 300 1	001437	•	painted	26	18	300	720	10	14,85
9R 350 350 1	001451		painted	26	18	350	696	5	11,35
9R 351 350 1	001475	•	painted	26	18	350	827	10	16,05
9R 350 400 19	022425		painted	28	18	400	814	5	13,20





Chisels

Mason's Chisels, flat oval

- Mainly used in the construction industry
- Profile material: flat oval
- Made of high-alloy tool steel
- Hardened throughout for maximum conveyance of the striking force, allows repeated regrinding of the working tip
- Special safety impact head prevents mushrooming and material splitting
- Golden dip-coated
- Requirements of current standards (e.g. DIN) are met or exceeded
- All tools are GS-approved



Art. No. 9R 340 300 1

Art. No.	EAN 4049002	Handguard	Finish	 mm	 mm	 mm	 g		Price €
9R 340 200 1	001185		painted	26	20 x 12	200	302	10	6,70
9R 340 250 1	001208		painted	26	20 x 12	250	380	10	8,10
9R 340 300 1	001222		painted	29	23 x 13	300	580	5	10,35
9R 340 350 1	001260		painted	29	23 x 13	350	700	5	11,75

Jointing Chisel





- Mainly used in the construction industry
- Made of high-alloy tool steel
- Hardened throughout for maximum conveyance of the striking force, allows repeated regrinding of the working tip
- Special safety impact head prevents mushrooming and material splitting
- Golden dip-coated
- Requirements of current standards (e.g. DIN) are met or exceeded
- All tools are GS-approved



Art. No. 9R 386 050 1



Art. No. 9R 385 060 1

Art. No.	EAN 4049002	Handguard	Finish	 mm	 mm	 mm	 g		Price €
9R 385 050 1	001932		painted	50	23 x 13	250	472	5	13,75
9R 385 060 1	001956		painted	60	26 x 13	250	545	5	13,95
9R 385 070 1	001970		painted	70	26 x 13	250	577	5	14,90
9R 386 080 1	026737	•	painted	80	26 x 13	250	734	10	21,30

Pointed Chisels

- Mainly used in the construction industry
- Made of high-alloy tool steel
- Hardened throughout for maximum conveyance of the striking force, allows repeated regrinding of the working tip
- Special safety impact head prevents mushrooming and material splitting
- Golden dip-coated
- Requirements of current standards (e.g. DIN) are met or exceeded
- All tools are GS-approved







Art. No. 9R 331 300 1



Art. No. 9R 330 300 1



Art. No.	EAN 4049002	Handguard	Finish	 mm	 mm	 mm	 g		Price €
9R 330 200 1	001017		painted		16	200	280	10	6,70
9R 330 250 1	001024		painted		16	250	362	10	7,60
9R 330 300 19	024108		painted		16	300	440	5	9,15
9R 331 300 19	027253	•	painted		16	300	698	10	13,60
9R 330 300 1	001062		painted		18	300	560	5	9,15
9R 331 300 1	001086	•	painted		18	300	698	10	13,95
9R 330 350 1	001109		painted		18	350	660	5	10,70
9R 330 400 19	024528		painted		18	400	780	5	11,25
9R 330 400 1	001147		painted		20	400	960	5	11,25

Chisels





Electrician's Slotting Chisels

- Mainly used in the construction industry
- Made of high-alloy tool steel
- Hardened throughout for maximum conveyance of the striking force, allows repeated regrinding of the working tip
- Special safety impact head prevents mushrooming and material splitting
- With two cutting edges for longitudinal slitting in masonry without interruption
- Golden dip-coated
- Requirements of current standards (e.g. DIN) are met or exceeded
- All tools are GS-approved



Art. No. 9R 366 250 1







Art. No.	EAN 4049002	Handguard	Finish	 mm	 mm	 mm	 g		Price €
9R 366 250 1	001710		painted	33	23 x 13	250	448	10	17,90

Electrician's Chisel

- Mainly used in the construction industry
- Made of high-alloy tool steel
- Hardened throughout for maximum conveyance of the striking force, allows repeated regrinding of the working tip
- Special safety impact head prevents mushrooming and material splitting
- Extra-slim design for working with precision
- Golden dip-coated
- Requirements of current standards (e.g. DIN) are met or exceeded
- All tools are GS-approved



Art. No. 9R 361 252 1





Art. No.	EAN 4049002	Handguard	Finish	 mm	 mm	 mm	 g		Price €
9R 360 202 1	001536		painted	10	8	200	79	10	3,90
9R 360 252 1	001550		painted	10	8	250	99	10	4,10
9R 361 252 1	001611		painted	12	10	250	154	10	4,95
9R 362 252 1	001673		painted	14	12	250	222	10	5,30

Electrician's Pointed Chisels

- Mainly used in the construction industry
- Made of high-alloy tool steel
- Hardened throughout for maximum conveyance of the striking force, allows repeated regrinding of the working tip
- Special safety impact head prevents mushrooming and material splitting
- Extra-slim design for working with pin-point precision
- Golden dip-coated
- Requirements of current standards (e.g. DIN) are met or exceeded
- All tools are GS-approved



Art. No. 9R 361 255 1





Art. No.	EAN 4049002	Handguard	Finish	 mm	 mm	 mm	 g		Price €
9R 361 255 1	008566		painted		10	250	146	10	4,95
9R 361 305 1	008641		painted		10	300	230	10	5,55

Floor chisels

- Mainly used in the construction industry
- Made of high-alloy tool steel
- Hardened throughout for maximum conveyance of the striking force, allows repeated regrinding of the working tip
- Special safety impact head prevents mushrooming and material splitting
- Short, powerful tool
- Golden dip-coated
- Requirements of current standards (e.g. DIN) are met or exceeded
- All tools are GS-approved



Art. No. 9R 370 100 1

Art. No.	EAN 4049002	Handguard	Finish	 mm	 mm	 mm	 g		Price €
9R 370 125 1	001772		painted	12	10	125	74	10	4,25





Chisels

Slitting Chisel, straight

- For stone and metal cutting
- Made of high-alloy tool steel
- Hardened throughout for maximum conveyance of the striking force, allows repeated regrinding of the working tip
- Special safety impact head prevents mushrooming and material splitting
- Extra-flat design
- Golden dip-coated
- Requirements of current standards (e.g. DIN) are met or exceeded
- All tools are GS-approved



Art. No. 9R 380 240 1

Art. No.	EAN 4049002	Handguard	Finish	 mm	 mm	 mm	 g		Price €
Slitting Chisel, straight									
9R 380 240 1	001833		painted	28	26 x 7	240	298	10	8,40
Slitting chisels, straight, with Euro Holder									
9R 380 240 1 SB	011832		painted	28	26 x 7	240	309	10	9,00





Slitting Chisel, offset

- For stone and metal cutting
- Made of high-alloy tool steel
- Hardened throughout for maximum conveyance of the striking force, allows repeated regrinding of the working tip
- Special safety impact head prevents mushrooming and material splitting
- Golden dip-coated
- Slitting chisel with offset tip
- Sharpened on both sides for flush working
- Requirements of current standards (e.g. DIN) are met or exceeded
- All tools are GS-approved



Art. No. 9R 380 241 1



Art. No.	EAN 4049002	Handguard	Finish	 mm	 mm	 mm	 g		Price €
9R 380 241 1	015632		painted	27	26 x 7	240	295	5	17,90

Flat Cold Chisel

- Predominantly used in metalworking
- Made of high-alloy tool steel
- Hardened throughout for maximum conveyance of the striking force, allows repeated regrinding of the working tip
- Special safety impact head prevents mushrooming and material splitting
- Golden dip-coated
- Requirements of current standards (e.g. DIN) are met or exceeded
- All tools are GS-approved







YouTube



Art. No. 9R 310 300 1



Art. No.	EAN 4049002	Handguard	Finish	 mm	 mm	 mm	 g		Price €
Flat Cold Chisels, flach oval									
9R 310 150 1	000638		painted	18	17x11	150	180	10	5,30
9R 310 175 1	000652		painted	21	20x12	175	260	10	6,45
9R 310 200 1	000676		painted	24	23x13	200	380	10	7,40
9R 310 250 1	000690		painted	25	23x13	250	480	10	9,20
9R 310 300 1	000737		painted	26	23x13	300	580	5	11,40
9R 310 400 1	000812		painted	27	23x13	400	800	5	15,15
Flat Cold Chisels, flat oval, with Euro Holder									
9R 310 150 1 SB	010637		painted	18	17x11	150	184	10	5,90
9R 310 175 1 SB	010651		painted	21	20x12	175	274	10	7,00
9R 310 200 1 SB	010675		painted	24	23x13	200	392	10	7,95
9R 310 250 1 SB	010699		painted	25	23x13	250	497	10	9,70
9R 310 300 1 SB	010736		painted	26	23x13	300	599	5	11,90

Chisels





Crosscut Chisel

- Predominantly used in metalworking
- Made of high-alloy tool steel
- Hardened throughout for maximum conveyance of the striking force, allows repeated regrinding of the working tip
- Special safety impact head prevents mushrooming and material splitting
- Golden dip-coated
- Requirements of current standards (e.g. DIN) are met or exceeded
- All tools are GS-approved

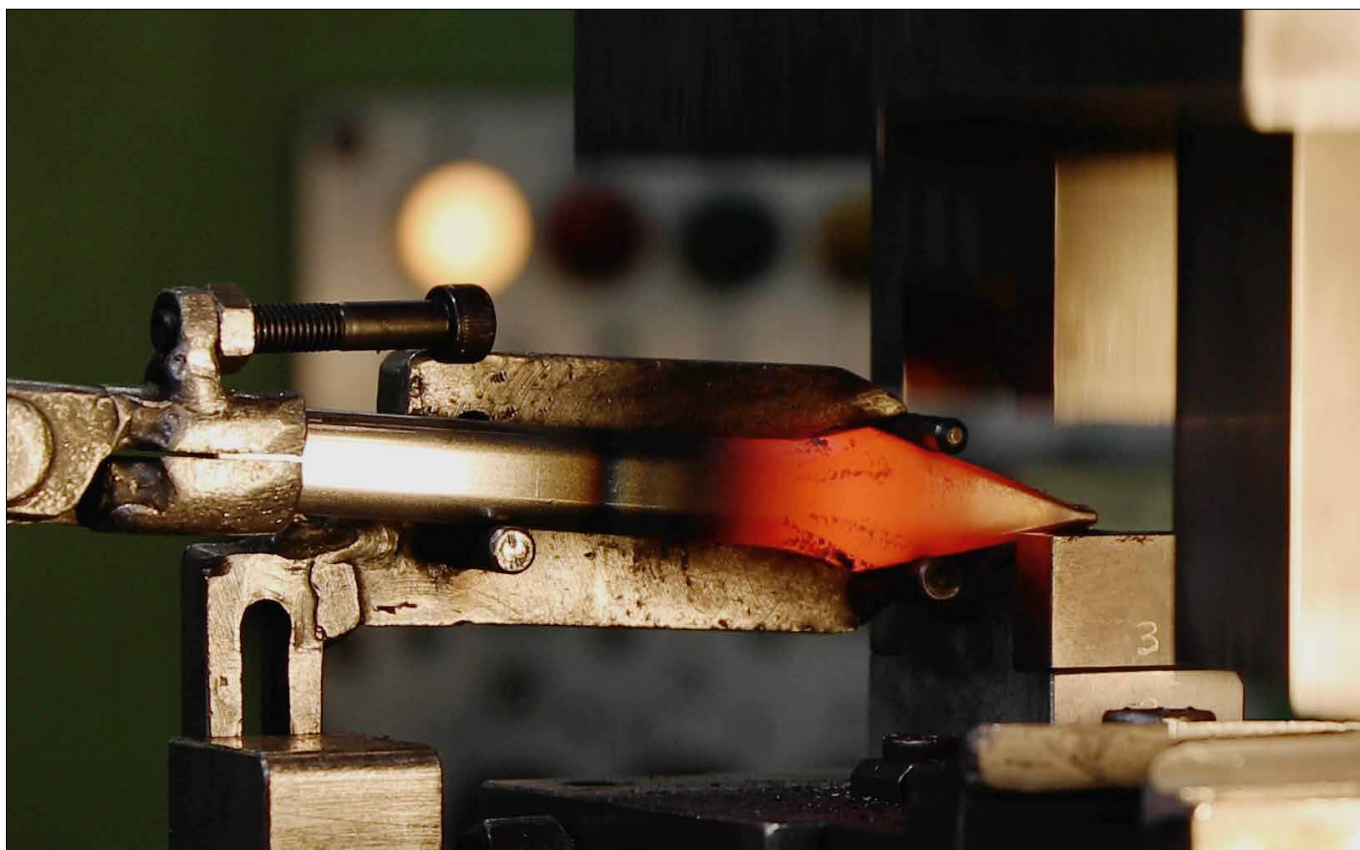



Art. No. 9R 320 300 1



Art. No.	EAN 4049002	Handguard	Finish	 mm	 mm	 mm	 g		Price €
9R 320 150 1	000874		painted	6	17x11	150	146	10	6,50
9R 320 200 1	000911		painted	8	20x12	200	260	10	7,90
9R 320 250 1	000935		painted	9	23x13	250	440	10	10,20

Tool sets

- Metalworking Tools
- Available in plastic stand, plastic case or metal case
- Version: polished tool head

Art. No.	EAN 4049002	Illustration	Contents	↔ mm	⚖ g	📦	Price €
9R 421 000 0	002175		312 125 0 Flat Cold Chisel 312 150 0 Flat Cold Chisel 322 125 0 Crosscut Chisel 430 120 0 Centre Punch 440 003 0 Taper Punches 440 004 0 Taper Punches		496	1	23,90
9R 421 002 0	002199		312 125 0 Flat Cold Chisel 312 150 0 Flat Cold Chisel 322 125 0 Crosscut Chisel 430 120 0 Centre Punch 440 003 0 Taper Punches 440 004 0 Taper Punches		702	1	31,10
9R 421 102 0	034473		312 126 0 Flat Cold Chisel 322 126 0 X Crosscut Chisel 430 122 0 Centre Punch 440 103 0 Taper Punches 440 104 0 Taper Punches		586	1	36,85

Shank chisels

Work powerfully using the
SDS plus system



Ground tip



Fully tempered and laser engraved



SDS plus chuck fit

Shank chisel applications

- Shank chisels for construction and demolition work, cleaning work and general chisel work in the construction industry
- Correct selection of chisel type and length enables optimum transfer of energy with minimum effort on the part of the user
- RENNSTEIG shank chisels meet the highest quality standards
- Use of high-quality materials and the latest manufacturing and heat treatment technologies
- Regrounding possible without any problems



Flat Cold Chisel

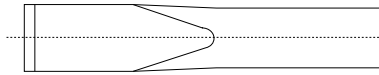

- For general chiselling and demolition work on masonry, concrete and loose rocks
- Small removal jobs
- precise breaking action

Pointed Chisels

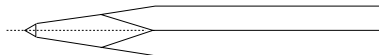

- For chiselling and demolition jobs on concrete and hard materials
- precise breaking action

Spade chisel

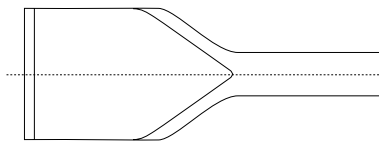

- For removing plaster from walls and floors
- Removal of heavy rust layers
- Wide range of applications

Floor chisels

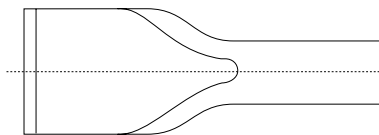

- For striking off plaster and tiles
 - Easy and convenient to use thanks to the angled shape of the chisel blade
-

Shank chisels

Chisels for electric hammers SDS plus

- For general chiselling and demolition work on masonry, concrete and loose rocks
- Made of high-alloy tool steel
- Hardened throughout for maximum conveyance of striking force
- Ground cutting edge
- Can be reground
- Requirements of current standards (e.g. DIN) are met or exceeded



Art. No. 9R 212 25000



Art. No. 9R 212 25001









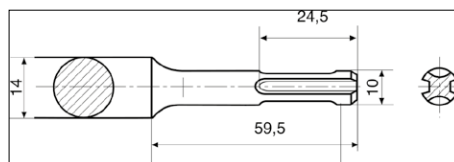

Art. No. 9R 212 25009

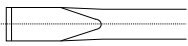

Art. No. 9R 212 25014

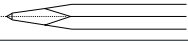

Art. No.	EAN 4049002	Tip	Type	Ø mm	 mm	↔ mm	 g		Price €
Shank chisels									
9R 212 25000	003349		Flat Cold Chisel	14 mm	20	250	248	10	8,60
9R 212 25001	003356		Pointed Chisels	14 mm		250	237	10	8,60
9R 212 25009	016523		Floor chisels	16 mm	40	250	346	10	16,15
9R 212 25014	003370		Spade chisel	16 mm	40	250	345	10	14,15
Shank chisels with Euro Holder									
9R 212 25000 SB	016530		Flat Cold Chisel	14 mm	20	250	259	5	9,15
9R 212 25001 SB	016547		Pointed Chisels	14 mm		250	247	5	9,15
9R 212 25014 SB	016561		Spade chisel	16 mm	40	250	355	5	14,65

Chisel Sets for Electric Hammers with SDS plus chuck

- Various chisel types combined in a set (3-piece) in a handy plastic box
- Standard chisel 250 mm long
- Chisel also available in short version (140 mm long) for optimised transmission of force with minimised weight (PCS = Power Chisel Short)



Art. No. 9R 212 00090



Art. No. 9R 212 00096



Art. No.	EAN 4049002	Contents	↔ mm	⚖ g	📦	Price €
9R 212 00090	013041	212 25000 Flat Cold Chisel 212 25001 Pointed Chisels 212 25014 Spade chisel		853	1	32,20
9R 212 00096	093159	212 14000 PCS-Flat cold chisel 212 14001 PCS-Pointed chisel 212 14020 PCS-Wide chisel		360	1	29,20

Wrecking Bar

Made tough for the tough jobs



Crowbar for leverage and pulling nails

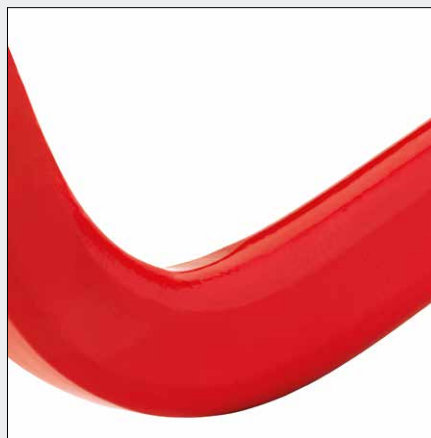

Flat oval cross section - up to 50% higher bending resistance vs hexagon cross section of same weight



Chisel end for levering and removing panels

Wrecking Bar

- Special tool steel, forged, flat oval or hexagonal cross-section
- ULTIMAX version exceptionally robust for the tough jobs
- Unbreakable thanks to a special manufacturing process
- Tips hardened and tempered
- Long-life powder coating (red) for better visibility on the construction site



Art. No. 9R 271 600 2







Art. No. 9R 275 600 2



Art. No. 9R 276 600 2



Art. No.	EAN 4049002	 mm	 mm	 g		Price €
Wrecking bars, hexagonal						
9R 271 400 2	007064		18	400	1,030	14,75
9R 271 500 2	003042		18	500	1,180	16,10
9R 271 600 2	003059		18	600	1,500	17,45
9R 271 700 2	023347		18	700	1,700	20,30
9R 271 800 2	003066		18	800	1,930	21,90
9R 271 1000 2	003073		20	1,000	2,860	30,90
ULTIMAX wrecking bars						
9R 275 600 2	024344	26 x 16		600	1,880	22,45
9R 275 800 2	024351	26 x 16		800	2,450	27,85
9R 275 1000 2	012082	26 x 16		1,000	3,060	34,60
Wrecking bars flat-oval						
9R 276 400 2	086694	20 x 12		400	800	14,75
9R 276 500 2	086700	20 x 12		500	980	15,90
9R 276 600 2	086717	23 x 13		600	1,400	16,80
9R 276 800 2	086724	23 x 13		800	1,900	20,60
9R 276 1000 2	086687	23 x 13		1,000	2,500	28,25

Disassembly tools

Double-edged screw extractor

- For damage-free removal of broken screws and bolts – Preserve high-value products
- Double edge - slip-proof two-edge penetration in threaded fastener
- For right and left-hand threads
- Center punch function
- Hexagonal head
- Of tempered CrV steel
- Black-oxide finish, polished cutting surface
- Service life will depend on fastener material





YouTube



Art. No. 9R 471 001 3



Art. No. 9R 471 002 3

Art. No.	EAN 4049002	Size	 mm	Drill Ø mm (min)	Drill Ø mm (max)	Screws min	Screws max	a/f inch	Drill min	Drill max	Screws min	Screws max	↔ mm	 g		Price €
9R 471 001 3	020872	1	6.35	3.2	4.8	M5	M6	1/4	1/8	3/16	3/16	1/4	59	9	1	6,05
9R 471 002 3	020889	2	9.5	4.8	7.1	M8	M10	3/8	3/16	1/4	5/16	3/8	66	20	1	6,05



Double-edged screw extractor sets

- Assortment of screw extractors for screws M5 to M20 (5-piece)
- Available in plastic pouch or metal case



Art. No. 9R 471 901 3

Art. No. 9R 471 900 3

Art. No.	EAN 4049002	Contents	↔ mm	 g		Price €
9R 471 900 3	019159	471 001 3 Double-edged screw extractor 471 002 3 Double-edged screw extractor 471 003 3 Double-edged screw extractor 471 004 3 Double-edged screw extractor 471 005 3 Double-edged screw extractor		242	1	40,30
9R 471 901 3	022791	471 001 3 Double-edged screw extractor 471 002 3 Double-edged screw extractor 471 003 3 Double-edged screw extractor 471 004 3 Double-edged screw extractor 471 005 3 Double-edged screw extractor		442	1	57,70

Spiral screw extractor

- For damage-free removal of broken screws and bolts – Preserve high-value products
- For right-hand thread only
- Of tempered CrV steel
- Black-oxide finish
- Service life will depend on fastener material



Art. No. 9R 470 001 3



Art. No. 9R 470 002 3

Art. No.	EAN 4049002	Size	Tip Ø mm	Shank Ø mm	Drill Ø mm (min)	Drill Ø mm (max)	Screws min	Screws max	↔ mm	⚖ g	📦	Price €
9R 470 001 3	000454	1	1.75	3.6	2	3.5	M3	M6	50	3	10	1,70
9R 470 002 3	000461	2	2.2	5	3	4.5	M6	M8	57	7	10	1,70

Screw extractor sets “Spiral”

- Various assortments of screw extractors in a plastic tube
- 5-piece for screws M3 to M18
- 6-piece for screws M3 to M24
- 8-piece for screws M3 to M45



Art. No. 9R 470 900 3



Art. No. 9R 470 901 3



Art. No. 9R 470 902 3

Art. No.	EAN 4049002	Contents	↔ mm	⚖ g	📦	Price €
9R 470 900 3	000539	470 001 3 Spiral screw extractor 470 002 3 Spiral screw extractor 470 003 3 Spiral screw extractor 470 004 3 Spiral screw extractor 470 005 3 Spiral screw extractor		110	1	12,20
9R 470 901 3	000546	470 001 3 Spiral screw extractor 470 002 3 Spiral screw extractor 470 003 3 Spiral screw extractor 470 004 3 Spiral screw extractor 470 005 3 Spiral screw extractor 470 006 3 Spiral screw extractor		217	1	16,70
9R 470 902 3	000553	470 001 3 Spiral screw extractor 470 002 3 Spiral screw extractor 470 003 3 Spiral screw extractor 470 004 3 Spiral screw extractor 470 005 3 Spiral screw extractor 470 006 3 Spiral screw extractor 470 007 3 Spiral screw extractor 470 008 3 Spiral screw extractor		707	1	40,30

Punching tools

Wad Punches

- For stamping out or producing gaskets and seal rings from materials such as rubber, leather, felt, plastic, cork, fabric or similar components
- Multi-layer wooden boards or polyamide boards should be used as a base impact support for stamping
- Made of special tool steel, forged
- Tool shape according to DIN 7200 A
- Conical, ground cutting head, slightly conical on the inside to remove stamped-out material
- Cutting edge sharpened, hardened and tempered
- Black dip-coated



Art. No. 9R 140 002 0



Art. No. 9R 140 020 0

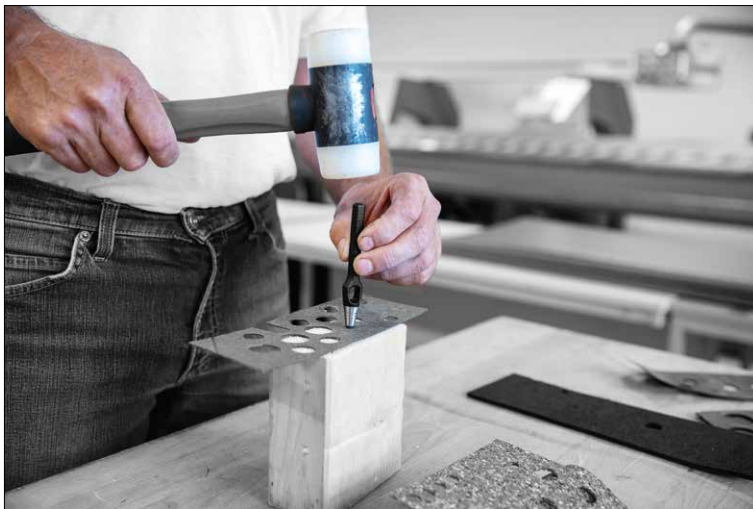

Art. No.	EAN 4049002	Hole dia. mm	Hole dia. Inch	↔ mm	⚖ g	📦	Price €
9R 140 002 0	140020	2	1/16	100	42	10	4,95
9R 140 003 0	140037	3	1/8	100	43	10	4,95
9R 140 004 0	140044	4	5/32	100	44	10	4,95
9R 140 005 0	140051	5	3/16	105	56	10	5,30
9R 140 006 0	140068	6	1/4	105	57	10	5,30
9R 140 007 0	140075	7	9/32	105	57	10	5,30
9R 140 008 0	140082	8	5/16	115	81	10	5,50
9R 140 009 0	140099	9	11/32	115	81	10	5,50
9R 140 010 0	140105	10	3/8	115	80	10	5,50
9R 140 011 0	140112	11	7/16	125	114	10	6,45
9R 140 012 0	140129	12	15/32	125	114	10	6,45
9R 140 013 0	140136	13	1/2	125	113	10	6,45
9R 140 014 0	140143	14	9/16	135	157	10	8,20
9R 140 015 0	140150	15		135	167	10	8,20
9R 140 016 0	140167	16	5/8	135	157	10	8,20
9R 140 018 0	140181	18	11/16	140	195	6	9,05
9R 140 019 0	140198	19	3/4	140	196	6	9,40
9R 140 020 0	140204	20	25/32	140	192	6	10,40

Set of Wad Punches

- Hole diameter 3–19 mm (in increments of 2 mm)
- Hole diameter. 2–30 mm (in increments of 2 mm)
- Black roll-up pouch made of durable polyester fabric



Art. No. 9R 140 902 0

Art. No. 9R 140 900 0

Art. No.	EAN 4049002	Contents	↔ mm	⚖ g	📦	Price €
9R 140 900 0	111778	140 003 0 Wad Punches 140 005 0 Wad Punches 140 007 0 Wad Punches 140 009 0 Wad Punches 140 011 0 Wad Punches 140 013 0 Wad Punches 140 015 0 Wad Punches 140 017 0 Wad Punches 140 019 0 Wad Punches		1,031	1	72,30
9R 140 902 0	111792	140 002 0 Wad Punches 140 004 0 Wad Punches 140 006 0 Wad Punches 140 008 0 Wad Punches 140 010 0 Wad Punches 140 012 0 Wad Punches 140 014 0 Wad Punches 140 016 0 Wad Punches 140 018 0 Wad Punches 140 020 0 Wad Punches 140 022 0 Wad Punches 140 024 0 Wad Punches 140 026 0 Wad Punches 140 028 0 Wad Punches 140 030 0 Wad Punches		3,059	1	176,10





Scrapers

Flat scrapers

- Flat scrapers, type A, similar to DIN 8350
- Slightly rounded, sharp working edge for working on metal surfaces
- Made of high-alloy tool steel
- Hardened throughout for optimum transmission of force
- Blue dip-coated
- Ergonomic real wood handle



Art. No. 9R 460 150 0

Art. No.	EAN 4049002	Blade length mm	 mm	 mm	 g		Price €
9R 460 200 0	002908	200	20x5	320	207	10	9,85





Triangular hollow-ground scrapers

- Triangular hollow-ground scrapers, type C, similar to DIN 8350
- For working on three-dimensional contours or for deburring work
- Ideal for hard-to-reach areas
- Made of high-alloy tool steel
- Hardened throughout for optimum transmission of force
- Blue dip-coated
- Working tip sharpened
- Ergonomic real wood handle



Art. No. 9R 462 200 0



Art. No.	EAN 4049002	Blade length mm	 mm		 g		Price €
9R 462 150 0	002977	150	14	260	120	10	8,10

Index Article Number

9R 140 002 0	36	9R 385 050 1	20
9R 140 003 0	36	9R 385 060 1	20
9R 140 004 0	36	9R 385 070 1	20
9R 140 005 0	36	9R 386 080 1	20
9R 140 006 0	36	9R 421 000 0	27
9R 140 007 0	36	9R 421 002 0	27
9R 140 008 0	36	9R 421 102 0	27
9R 140 009 0	36	9R 424 120 0	16
9R 140 010 0	36	9R 424 130 0	16
9R 140 011 0	36	9R 425 152 0	12
9R 140 012 0	36	9R 425 154 0	14
9R 140 013 0	36	9R 425 160 0	12
9R 140 014 0	36	9R 425 170 0	13
9R 140 015 0	36	9R 425 530 6 RC	13
9R 140 016 0	36	9R 430 100 0	9
9R 140 018 0	36	9R 430 100 0 SB	9
9R 140 019 0	36	9R 430 120 0	9
9R 140 020 0	36	9R 430 120 0 SB	9
9R 140 900 0	37	9R 430 129	7
9R 140 902 0	37	9R 430 130	7
9R 212 00090	31	9R 430 131	7
9R 212 00096	31	9R 430 143	8
9R 212 25000	30	9R 430 229	7
9R 212 25000 SB	30	9R 430 230	7
9R 212 25001	30	9R 430 231	7
9R 212 25001 SB	30	9R 431 120 0	9
9R 212 25009	30	9R 432 120 0	9
9R 212 25014	30	9R 433 150 0	9
9R 212 25014 SB	30	9R 434 150 0	9
9R 271 1000 2	33	9R 439 129	7
9R 271 400 2	33	9R 439 130	7
9R 271 500 2	33	9R 439 131	7
9R 271 600 2	33	9R 440 002 0	15
9R 271 700 2	33	9R 440 003 0	15
9R 271 800 2	33	9R 440 004 0	15
9R 275 1000 2	33	9R 440 005 0	15
9R 275 600 2	33	9R 445 135 5	17
9R 275 800 2	33	9R 445 136 5	17
9R 276 1000 2	33	9R 450 002 0	12
9R 276 400 2	33	9R 450 003 0	12
9R 276 500 2	33	9R 450 004 0	12
9R 276 600 2	33	9R 450 005 0	12
9R 276 800 2	33	9R 450 006 0	12
9R 310 150 1	25	9R 450 008 0	12
9R 310 150 1 SB	25	9R 450 010 0	12
9R 310 175 1	25	9R 450 025 0	12
9R 310 175 1 SB	25	9R 451 012 0	12
9R 310 200 1	25	9R 455 170 5	17
9R 310 200 1 SB	25	9R 457 100 5	13
9R 310 250 1	25	9R 460 200 0	38
9R 310 250 1 SB	25	9R 462 150 0	38
9R 310 300 1	25	9R 470 001 3	35
9R 310 300 1 SB	25	9R 470 002 3	35
9R 310 400 1	25	9R 470 900 3	35
9R 320 150 1	26	9R 470 901 3	35
9R 320 200 1	26	9R 470 902 3	35
9R 320 250 1	26	9R 471 001 3	34
9R 330 200 1	21	9R 471 002 3	34
9R 330 250 1	21	9R 471 900 3	34
9R 330 300 1	21	9R 471 901 3	34
9R 330 300 19	21		
9R 330 350 1	21		
9R 330 400 1	21		
9R 330 400 19	21		
9R 331 300 1	21		
9R 331 300 19	21		
9R 340 200 1	20		
9R 340 250 1	20		
9R 340 300 1	20		
9R 340 350 1	20		
9R 350 200 1	19		
9R 350 250 1	19		
9R 350 300 19	19		
9R 350 350 1	19		
9R 350 400 19	19		
9R 351 300 1	19		
9R 351 300 19	19		
9R 351 350 1	19		
9R 360 202 1	22		
9R 360 252 1	22		
9R 361 252 1	22		
9R 361 255 1	23		
9R 361 305 1	23		
9R 362 252 1	22		
9R 366 250 1	22		
9R 370 125 1	23		
9R 380 240 1	24		
9R 380 240 1 SB	24		
9R 380 241 1	24		



Manufacturer

Rennsteig Werkzeuge GmbH

An der Koppel 1
98587 Steinbach-Hallenberg
Germany

Telefon: +49 (0) 36847 / 4 41-0
Fax: +49 (0) 36847 / 4 41-14

info@rennsteig.com
www.rennsteig.com



Supplier

Your distributor

KNIPEX-Werk

C. Gustav Putsch KG
Oberkamper Strasse 13
42349 Wuppertal

Telefon: +49 (0) 202 – 47 94 0
Fax: +49 (0) 202 – 47 50 58 (national)
+49 (0) 202 – 47 74 94 (international)

info@knipex.de
www.knipex.de

X-ON Electronics

Largest Supplier of Electrical and Electronic Components

Click to view similar products for [Crimpers / Crimping Tools](#) category:

Click to view products by [Rennsteig](#) manufacturer:

Other Similar products are found below :

[010-0096](#) [CT150-2-D02](#) [CT150-6-RH07](#) [622-6441LF](#) [63484-3701](#) [63800-8355](#) [63819-1875](#) [63819-2875](#) [63819-4475](#) [63827-5375](#) [662903-2](#)
[690602-6](#) [7-23471-1](#) [734611-1](#) [762637-1](#) [811242-5](#) [91362-1](#) [1-21002-3](#) [1-21002-7](#) [12118040](#) [12085270](#) [12387119-6](#) [1-22548-4](#) [125442-1](#)
[DCE.91.073.BVC](#) [DCE.91.090.3MVM](#) [DCE.91.130.5MVU](#) [DCE.91.162.BVCM](#) [DCE.91.202.BVCM](#) [1310G2](#) [1333249-1](#) [1-354003-0](#)
[1338301-1](#) [DF62/RE-MD](#) [AP105-DF11-2428S\(64\)](#) [1456088-1](#) [1-45804-6](#) [15397700](#) [AX100749](#) [1-59619-7](#) [1596970-1](#) [1-59619-8](#) [1901238-](#)
[2](#) [2119581-1](#) [K761](#) [KTH-1079](#) [KTH-2022](#) [KTH-2260](#) [904139-1](#) [307130-2](#)