

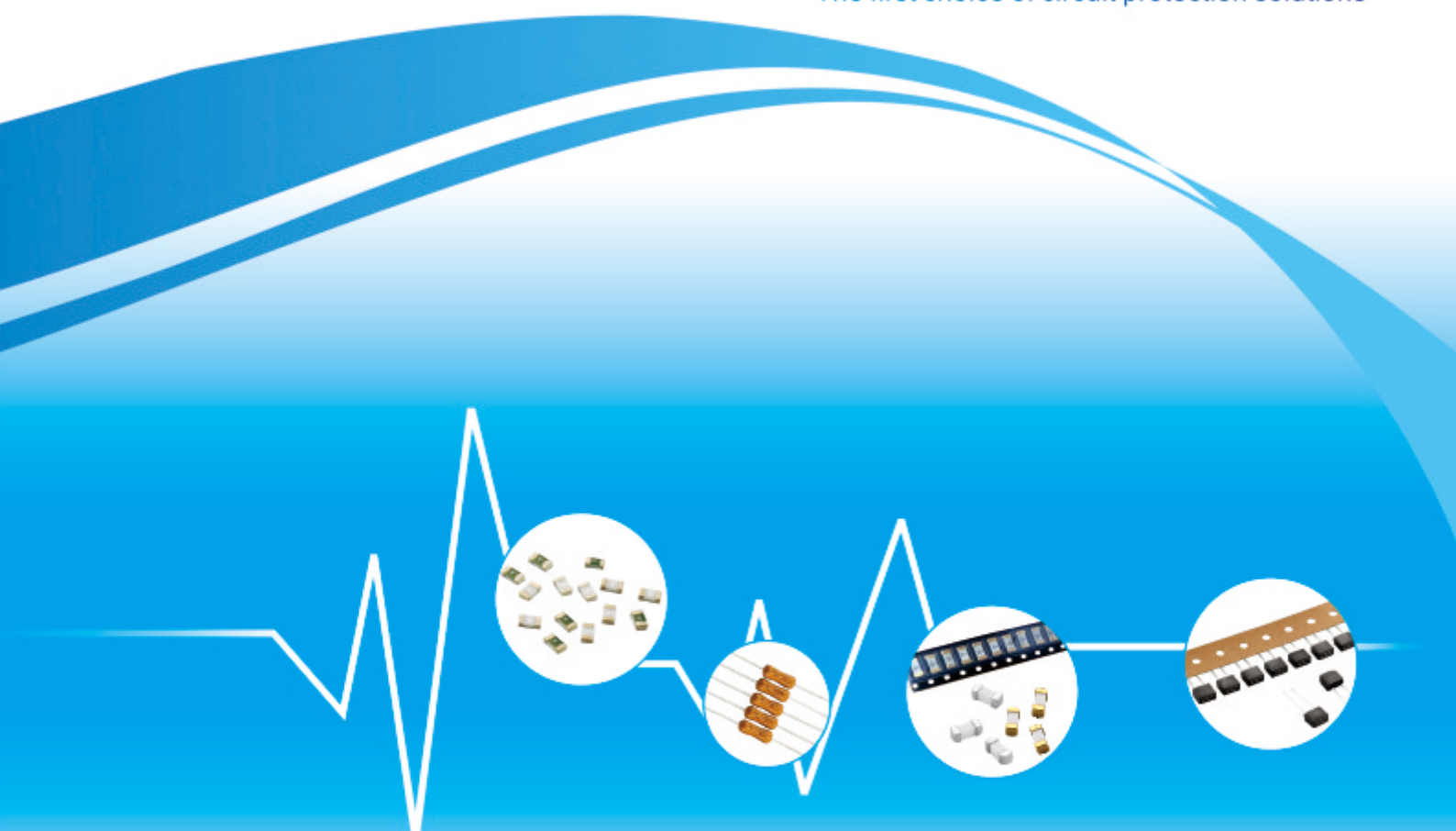

Fuses

The first choice of circuit protection solutions



您的電路保護專家
Your Circuit Protection Expert





公司簡介

東莞市瑞邁電子科技有限公司(REOMAX瑞邁)于1999年成立，我們專注于生產各種電流保險絲，溫度保險絲及其它電路保護元器件。產品廣泛應用于消費電子、移動設備、家用電器、照明電器、電源供應器及適配器、通訊設備、太陽能電場裝置以及工業電力控制設備等領域。

我司目前擁有現代化的生產廠房2500多平方米，擁有各種先進的自動化加工組裝和檢測設備，每月產能近5000萬祇，作為全國熔斷器標準化技術委員會小型熔斷器成員單位之一，參與起草并制訂小型熔斷器的國家標準及行業標準。擁有獨立自主的科研及技術開發創新能力。公司已通過了ISO9001國際質量體系認證，并獲得了UL/cUL/VDE/CCC/CQC/PSE/KC/TUV等各國安規認證，符合最新的RoHS環保指令和REACH法規要求。經過十餘年的發展，公司煅煉出一批經驗豐富技術熟練的研發、生產、品質管理團隊，產品質量穩定性始終處于行業領先地位。

公司以"客戶至上、精誠合作、開拓創新、持續提升"作為企業的核心文化，傾力打造滿足用戶需求的優質精品，以成為"業界優秀電路保護生產商"為經營目標。





About REOMAX

Reomax Electronics Co., Ltd was founded in 1999, focus on manufacturing fuses for over-current, over-temperature and other circuit protection components. Reomax products are widely used in various kinds of electronic devices, such as consumer electronics, mobile terminal, household appliances, lighting appliances, power supplies and adapters. We have acquired ISO9001 quality management system, our products acquired agency approvals of UL/cUL/VDE/CCC/CQC/PSE/KC/TUV, and RoHS &REACH compliance.

After served our valuable clients in China market over 10 years, Reomax fuses are becoming one of the leading fuses suppliers, and in order to create more value and save more cost for our global clients, we start to provide the shortest fuses product supply chain mode and we are now available in worldwide.

Reomax believes in "customer first, sincere cooperation, continuous improvement and innovation", take continuing efforts in manufacture high quality products to meet the demands of users, and our goal is to become the "excellent circuit protection manufacturer".

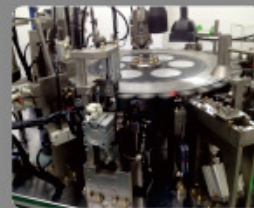
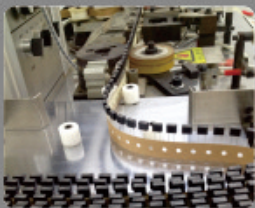

Fuse Selection Steps / 選用保險絲的基本步驟

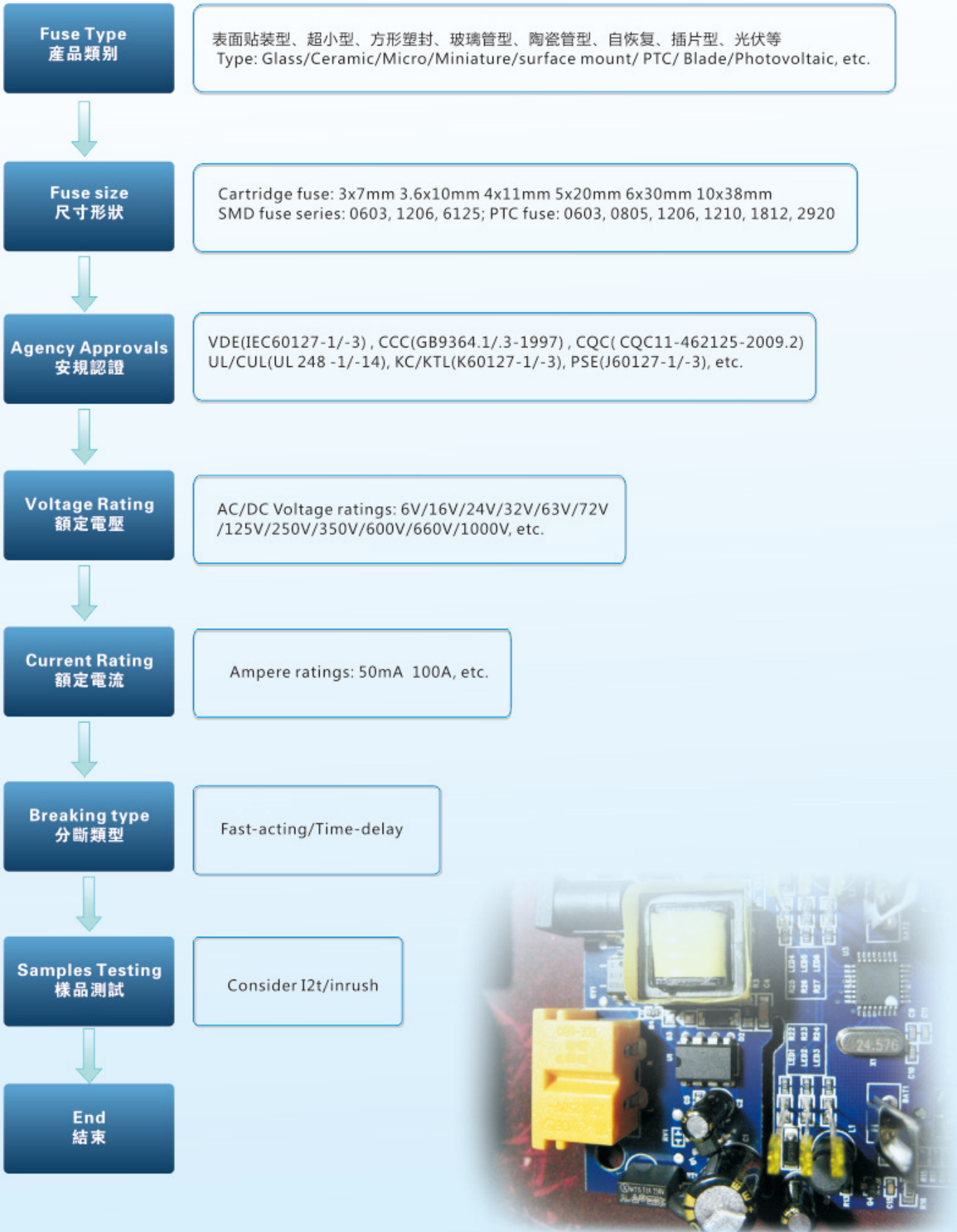



資質證書 Certificates



客户至上、精誠合作、開拓創新、持續提升
"customer first, sincere cooperation, continuous improvement and innovation"



目錄/Content

	公司简介 About REOMAX
	资质证书 Certificates
01	06. 000 Series 0603 Fast-Acting SMD Fuses
02	06. 100 Series 0603 Slow-Blow SMD Fuses
03	12. 000 Series 1206 Fast-Acting SMD Fuses
04	12. 100 Series 1206 Slow-Blow SMD Fuses
05	6125 series, Surface Mount fuse Fast-Acting 125V/250V/300V
06	6125 series, Surface Mount fuse Slow-Blow 125V/250V/300V
07	R1032 series, Fast-Acting(Time-Lag) 32V-400V
08	R1245F series, Fast-Acting(Time-Lag) 32V-250V
09	8x4x5mm MFC Series Fast-Acting Radial Lead Micro Fuse
10	8x4x5mm MTC Series Time-Lag Radial Lead Micro Fuse
11	8x4x7mm MFS Serues Fast-Acting Radial Lead Micro Fuse 250V
12	8x4x7mm MTS Serues Time-Lag Radial Lead Micro Fuse 250V
13	8x4x7mm NFS Series Fast-Acting Radial Lead Micro Fuse 300V
14	8x4x7mm NTS Series Time-Lag Radial Lead Micro Fuse 300V
15	FMS Series 8*4mm Fast-Acting Radial Lead Micro Fuse 350V
16	TMS Series 8*4mm Time-Lag Radial Lead Micro Fuse 350V
17	12x6x9mm 96F Series Fast-Acting Radial Lead Micro Fuse
18	12x6x9mm 96T Series Time-Lag Radial Lead Micro Fuse
19	SFB Series 3 * 7mm Fast-Acting Subminiature Fuses
20	STB Series 3 * 7mm Time-Lag Subminiature Fuses
21	RFP Series 4 * 11mm Fast-Acting Subminiature Fuses
22	RTP Series 4 * 11mm Time-Lag Subminiature Fuses
23	SFP Series 3.6*10mm Fast-Acting Glass Tube Fuse
24	STP Series 3.6*10mm Time-Lag Glass Tube Fuse
25	FBP Series 3.6*10mm Fast-Acting Glass Tube Fuse
26	TBP Series 3.6*10mm Time-Lag Glass Tube Fuse
27	SFC Series 5*20mm Fast-Acting Glass Tube Fuse
28	STC Series 5*20mm Time-Lag Glass Tube Fuse
29	FBC Series 5*20mm Fast-Acting Glass Tube Fuse
30	TBC Series 5*20mm Time-Lag Glass Tube Fuse
31	MFC Series 6*32mm Fast-Acting Glass Tube Fuse
32	MTC Series 6*32mm Time-Lag Glass Tube Fuse
33	PFU/HFP Series 3.6*10mm Fast-Acting Ceramic Tube Fuse
34	PTU/HTP Series 3.6*10mm Time-Lag Ceramic Tube Fuse
35	BFC Series 5*20mm Fast-Acting Ceramic Tube Fuse
36	BTC Series 5*20mm Time-Lag Ceramic Tube Fuse
37	BMF Series 6.35*32mm Fast-Acting Ceramic Tube Fuse
38	BMT Series 6.35*32mm Time-Lag Ceramic Tube Fuse
39	5.250/5.300/5.500/5.700 Series Fast-Acting(Time-Lag) Ceramic Tube Fuse
40	6.250/6.300/6.500/6.600/6.750/6.000 Series Fast-Acting(Time-Lag) Ceramic Tube Fuse
41	Fast acting fuse 快速熔断器
42	光伏熔断器及底座 Photovoltaic fuse&holders 放电管SMD 4532/1812
43	绕线.金属膜.氧化膜.碳膜.电阻器系列 FIXED RESISTOR
44	AFB系列耐冲击型超小型快断保险丝 AFB Series Impact resistance type Fast-Acting Micro Fuse
45	PTC fuse 自恢复保险丝 SMD type 贴片系列
46	PTC fuse 自恢复保险丝 电力型铝壳绕线电阻器 large capacity metal-clad wire wound resisor
47	热熔断体.温度保险丝 Temperature fuse
48	9700热保护器 9700 thermal protector
49	Fast acting fsue 快速熔断器底座及配件
50-51	线路板/面板安装保险丝座 PCB/Panel mounting fse holders
52	汽车保险丝及底座 Automobile frses&holders

0603 Fast Acting SMD Fuses 06.000 Series



Description

06.000 Series fast-acting chip fuses help provide overcurrent protection for systems using DC power sources up to 63VDC.

Help provide higher hold current in the smaller footprint, improve product reliability and quality, enhance high-temperature performance in a wide range of circuit designs.

Electrical Characteristics

Rated Current	1.0In	2.0In
250mA~8A	4 hour minimum	60 sec maximum

Features

- Lead-Free and RoHS compliant
- High inrush current withstanding capability
- Compatible with reflow and wave solder
- Excellent environmental integrity
- One time positive disconnect
- Suitable for rated current of 250mA-8A
- Operating temperature range -55°C to +125°C (consider de-rating)

Applications

- USB charger
- Laptops
- Digital cameras
- Cell phones
- Printers
- DVD players
- Portable electronics
- Game systems
- LCD monitors
- Scanners

Specification

Part No.	Rated Voltage		Rated Current (A)	Breaking Capacity (A)	Typical Cold Resistance (mOhms) ²	Typical Voltage Drop (mV)	Typical Pre-Arching I ² t (A ² Sec) ²	Alpha Mark
	DC							
06.000.0.25	63V	-	0.250	50A	3250	893	0.00042	D
06.000.0.375			0.375	50A	1310	587	0.00093	E
06.000.0.5			0.500	50A	1070	582	0.0020	F
06.000.0.75			0.750	50A	470	427	0.0092	G
06.000.1			1	50A	300	295	0.011	B
06.000.1.5			1.5	50A	150	220	0.045	H
06.000.2			2	50A	72	160	0.115	K
06.000.2.5	32V	-	2.5	50A	52	145	0.14	L
06.000.3			3	50A	35	130	0.21	O
06.000.3.5			3.5	50A	23.8	130	0.55	R
06.000.4			4	50A	21	120	0.52	S
06.000.5			5	50A	14	110	1.20	T
06.000.6			6	50A	8	110	1.70	V
06.000.7			7	50A	5.6	80	2.30	X
06.000.8			8	50A	3.5	75	3.00	Z

- DC Interrupting Rating (Measured at rated voltage, time constant of less than 50 microseconds, battery source)
- DC Cold Resistance are measured at <10% of rated current in ambient temperature of 25degrees
- Typical Pre-arching I²t are measured at 10In Current
- For fuse below 1A, the color of glass coating is Blue; for 1A and above, it's Green.

Dimension (Unit: mm/inch)

Packaging

5,000 pcs per reel

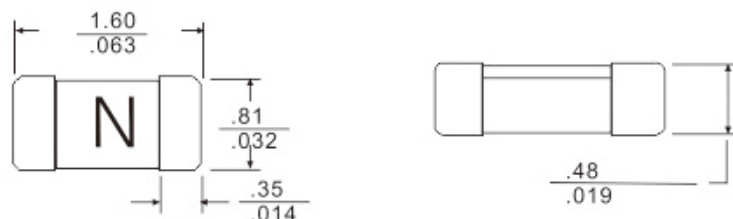

0603 Slow Blow SMD Fuses
06.100 Series



Description

06.100 Series slow-blow chip fuses help provide overcurrent protection for systems using DC power sources up to 32VDC. Help provide higher hold current in the smaller footprint, improve product reliability and quality, enhance high-temperature performance in a wide range of circuit designs.

Electrical Characteristics

Rated Current	1.0In	2.0In	2.5In
1A~8A	4 hour minimum	1~60 sec	5 sec maximum

Features

- Lead-Free and RoHS compliant
- High inrush current withstanding capability
- Compatible with reflow and wave solder
- Excellent environmental integrity
- One time positive disconnect
- Suitable for rated current of 1A-8A
- Operating temperature range -55°C to +125°C (consider de-rating)

Applications

- USB charger
- Laptops
- Digital cameras
- Cell phones
- Printers
- DVD players
- Portable electronics
- Game systems
- LCD monitors
- Scanners

Specification

Part No .	Rated Voltage	Rated Current (A)	Breaking Capacity (A)	Typical Cold Resistance (mOhms) ²	Typical Voltage Drop (mV)	Typical Pre-Arcing I ² t (A ² Sec) ³	Alpha Mark
	DC						
06.100.1	63V	1	50A	300	345	0.011	B
06.100.1.5		1.5	50A	150	270	0.045	H
06.100.2		2	50A	72	160	0.115	K
06.100.2.5		2.5	50A	52	145	0.14	L
06.100.3		3	50A	35	130	0.21	O
06.100.3.5		3.5	50A	23.8	130	0.55	R
06.100.4		4	50A	21	120	0.52	S
06.100.5		5	50A	14	110	1.70	T
06.100.6	-	6	50A	8	110	2.30	V
06.100.7		7	50A	6.2	90	3.0	X
06.100.8		8	50A	4.1	80	4.5	Z

- DC Interrupting Rating (Measured at rated voltage, time constant of less than 50 microseconds, battery source)
- DC Cold Resistance are measured at <10% of rated current in ambient temperature of 25degrees
- Typical Pre-arcing I²t are measured at 10In Current

Dimension (Unit: mm/inch)

Packaging
 5,000 pcs per reel

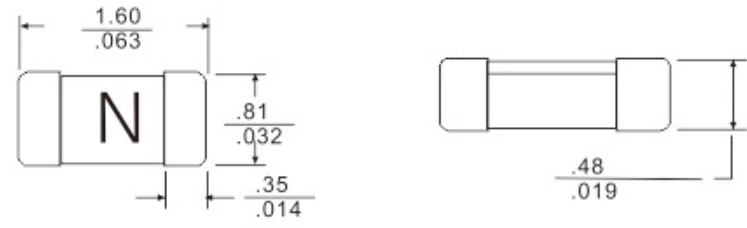

1206 Fast Acting SMD Fuses 12. 000 Series

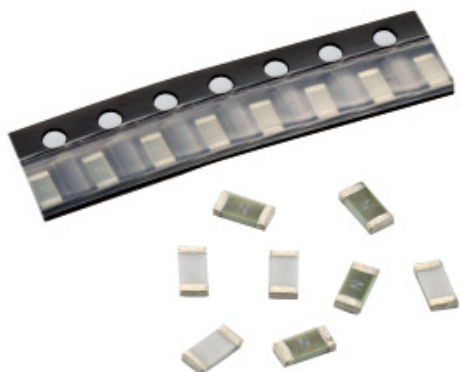

Description

12.000 Series fast-acting chip fuses help provide overcurrent protection for systems using DC power sources up to 72VDC.

Help provide higher hold current in the smaller footprint, improve product reliability and quality, enhance high-temperature performance in a wide range of circuit designs.

Electrical Characteristics

Rated Current	1.0In	2.5In	3.5In
250mA~5A	4 hour min.	5 sec max.	-
6A~30A		-	5 sec max.

Features

- Lead-Free and RoHS compliant
- High inrush current withstanding capability
- Compatible with reflow and wave solder
- Excellent environmental integrity
- One time positive disconnect
- Suitable for rated current of 250mA-30A
- Operating temperature range -55°C to +125°C (consider de-rating)

Applications

- USB charger
- Laptops
- Digital cameras
- Cell phones
- Printers
- DVD players
- Portable electronics
- Game systems
- LCD monitors
- Scanners

Specification

Part No.	Rated Voltage	Rated Current (A)	Breaking Capacity (A)			Typical Cold Resistance (mOhms) ²	Typical Voltage Drop (mV)	Typical Pre-Arcing I ² t (A ² Sec) ³	Alpha Mark
			72V	32V	24V				
12.000.0.25	63V	250mA	50A	50A	150A	3608	1407	0.0004	-2.5
12.000.0.375		375mA				1882	718	0.0008	E
12.000.0.5		500mA				1028	650	0.0022	0.5
12.000.0.75		750mA				601	616	0.0057	-7.5
12.000.1		1A				490	510	0.10	H
12.000.1.25		1.25A				165	184	0.021	▲
12.000.1.5		1.5A				240	367	0.15	K
12.000.2		2A				144	316	0.41	N
12.000.2.5		2.5A				83	240	0.65	O
12.000.3		3A				53	187	1.39	P
12.000.3.5	32V	3.5A	50A	150A	40	180	1.68	R	
12.000.4		4A			35	173	1.73	S	
12.000.4.5		4.5A			27	164	2.62	X	
12.000.5		5A			22	141	2.89	T	
12.000.6.5		6.5A			16	140	3.4	6.5	
12.000.7		7A			12	140	5.68	7	
12.000.10		10A			4.4	59	2.16	10	
12.000.12		12A			3.8	67	7.11	12	
12.000.15		15A			2.9	66	23.89	15	
12.000.20		20A			1.6	60	47.17	20	
12.000.25	25A	1.4	57	32	25				
12.000.30	30A	1	68	43	30				

- DC Interrupting Rating (Measured at rated voltage, time constant of less than 50 microseconds, battery source)
- DC Cold Resistance are measured at <10% of rated current in ambient temperature of 25°C

Dimension (Unit: mm)

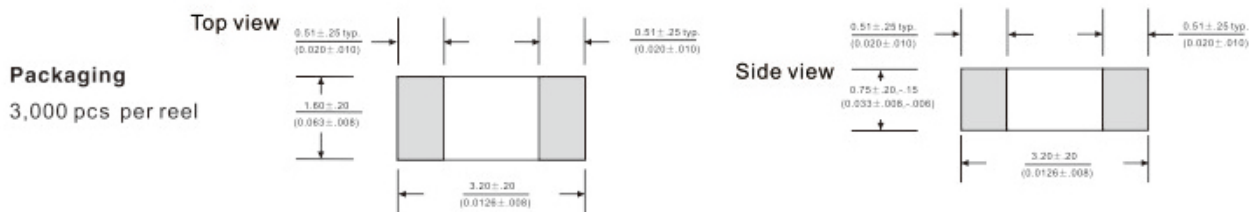

1206 Slow Blow SMD Fuses 12. 100 Series

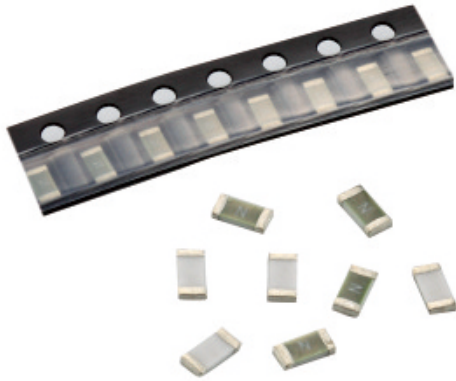

Description

12.100 Series slow-blow chip fuses help provide overcurrent protection for systems using DC power sources up to 72VDC.

Help provide higher hold current in the smaller footprint, improve product reliability and quality, enhance high-temperature performance in a wide range of circuit designs.

Electrical Characteristics

Rated Current	1.0In	2.5In	3.0In	10.0In
1A~10A	4 hour min.	5 sec max .	0.1 sec -3sec	0.2 sec -20sec

Features

- Lead-Free and RoHS compliant
- High inrush current withstanding capability
- Compatible with reflow and wave solder
- Excellent environmental integrity
- One time positive disconnect
- Suitable for rated current of 1A-7A
- Operating temperature range -55°C to +125°C (consider de-rating)

Applications

- USB charger
- Laptops
- Digital cameras
- Cell phones
- Printers
- DVD players
- Portable electronics
- Game systems
- LCD monitors
- Scanners

Specification

Part No .	Rated Voltage		Rated Current (A)	Breaking Capacity (A)	Typical Cold Resistance (mOhms) ²	Typical Voltage Drop (mV)	Typical Pre-Arcing I ² t (A ² Sec) ³	Alpha Mark
	DC							
12.100.1	63V 72V 125V	32V 24V	1	50A	480	510	0.11	H
12.100.1.5			1.5	50A	230	367	0.17	K
12.100.2			2	50A	140	316	0.43	N
12.100.2.5			2.5	50A	80	240	0.68	O
12.100.3			3	50A	50	187	1.41	P
12.100.3.5			3.5	50A	38	180	1.72	R
12.100.4			4	50A	34	173	1.78	S
12.100.4.5			4.5	50A	25	164	2.65	X
12.100.5			5	50A	21.5	145	2.91	T
12.100.7			7	50A	12.3	140	5.72	7
12.100.8	-	-	8	300A	10	123	6.8	M
12.100.10	-	-	10	300A	7	110	10.6	U

- DC Interrupting Rating (Measured at rated voltage, time constant of less than 50 microseconds, battery source)
- DC Cold Resistance are measured at <10% of rated current in ambient temperature of 25degrees
- Typical Pre-arching I²t are measured at 10In Current

Dimension (Unit: mm/inch)

Packaging

3,000 pcs per reel

Top view

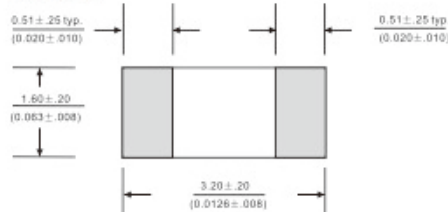

Side view

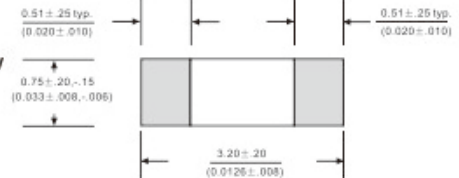

2410/6125 Series, Surface Mount fuse Fast-Acting 125V/250V/300V

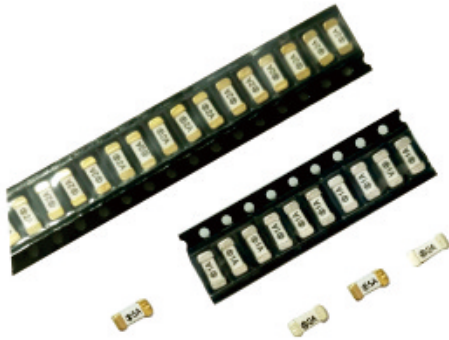

Description

6125 Series fast-acting square Surface Mount fuses are ceramic tube/ end cap constructions, RoHS compliant, Halogen Free and lead-free, with U.S. (UL/CSA) safety agency approvals. Provide board level primary and secondary circuit protection in a wide variety of applications, end caps are available in copper or silver plated.

Electrical Characteristics(UL/CSA,248-14) File No.E340427

Ampere Rating	% of current Rating	Blowing Time
0.05A-15A	100%	>4hours
0.05A-15A	200%	<120sec

Features

- Lead-Free and RoHS compliant
- Inrush withstand capability
- Wide range of current rating (125V/250V/300V)
- Wide range of current rating (50mA-15A)
- Excellent environmental integrity
- Operating temperature range -55°C to +125°C (consider de-rating)

Applications

- LED driver
- Notebook/Laptops
- PC computer
- Office electronic equipment
- Digital camera
- LCD/LED monitor/TV/backlight inverter
- Networking device
- Telecom device
- Industrial equipment
- Power supply

Catalog Number	Ampere Rating(A)	Voltage Rating(V)	Interrupting Rating
SEF0062	0.062	250V SEF(0.05-7A)	50A@250V/300V 200A@125V
SEF0080	0.080		
SEF0100	0.100		
SEF0125	0.125		
SEF0200	0.200		
SEF0250	0.250		
SEF0300	0.300	300V SSF(0.05-7A)	
SEF0375	0.375		
SEF0400	0.400		
SEF0500	0.500		
SEF0600	0.600	125V SFE(0.05-15A)	
SEF0630	0.630		
SEF0700	0.700		
SEF0750	0.750		
SEF0800	0.800		
SEF1100	1		

Catalog Number	Ampere Rating(A)	Voltage Rating(V)	Interrupting Rating
SEF1125	1.25	250V SEF(0.05-7A)	50A@250V/300V 200A@125V
SEF1150	1.5		
SEF1160	1.6		
SEF1200	2		
SEF1250	2.5		
SEF1300	3		
SEF1315	3.15	300V SSF(0.05-7A)	
SEF1350	3.5		
SEF1400	4		
SEF1500	5		
SEF1600	6	125V SFE(0.05-15A)	
SEF1630	6.3		
SEF1700	7		
SEF1750	7.5		
SEF1800	8		
SEF2100	10		
SEF2120	12		
SEF2150	15		

Dimension (Unit: mm)

Materials

Body: ceramic
 End caps: Copper or Silver plated brass
 Fuse element: Alloy wire

Packaging

1,000 pcs per reel

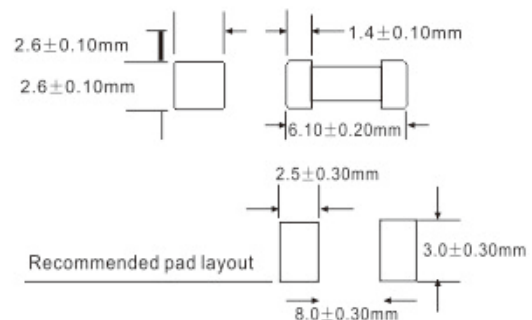

2410/6125 Series, Surface Mount fuse
Slow Blow 125V/250V/300V

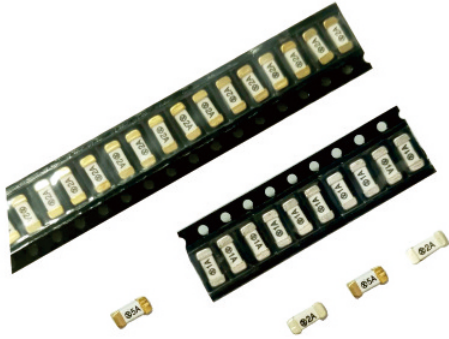

Description

6125 Series slow-blow square Surface Mount fuses are ceramic tube/ end cap constructions, RoHS compliant, Halogen Free and lead-free, with U.S. (UL/CSA) safety agency approvals. Provide board level primary and secondary circuit protection in a wide variety of applications, end caps are available in copper or silver plated.

Electrical Characteristics(UL/CSA,248-14) File No.E340427

Ampere Rating	% of current Rating	Blowing Time
0.05A-15A	100%	>4hours
0.05A-15A	200%	<120sec

Features

- Lead-Free and RoHS compliant
- Inrush withstand capability
- Wide range of current rating (125V/250V/300V)
- Wide range of current rating (50mA-15A)
- Excellent environmental integrity
- Operating temperature range -55°C to +125°C (consider de-rating)

Applications

- LED driver
- Notebook/Laptops
- PC computer
- Office electronic equipment
- Digital camera
- LCD/LED monitor/TV/backlight inverter
- Networking device
- Telecom device
- Industrial equipment
- Power supply

Catalog Number	Ampere Rating(A)	Voltage Rating(V)	Interrupting Rating
SET0062	0.062	250V SET(0.05-7A)	50A@250V/300V 200A@125V
SET0080	0.080		
SET0100	0.100		
SET0125	0.125		
SET0200	0.200		
SET0250	0.250		
SET0300	0.300	300V SST(0.05-7A)	
SET0375	0.375		
SET0400	0.400		
SET0500	0.500	125V STE(0.05-15A)	
SET0600	0.600		
SET0630	0.630		
SET0700	0.700		
SET0750	0.750		
SET0800	0.800		
SET1100	1		

Catalog Number	Ampere Rating(A)	Voltage Rating(V)	Interrupting Rating
SET1125	1.25	250V SEF(0.05-7A)	50A@250V/300V 200A@125V
SET1150	1.5		
SET1160	1.6		
SET1200	2		
SET1250	2.5		
SET1300	3		
SET1315	3.15	300V SSF(0.05-7A)	
SET1350	3.5		
SET1400	4		
SET1500	5	125V SFE(0.05-15A)	
SET1600	6		
SET1630	6.3		
SET1700	7		
SET1750	7.5		
SET1800	8		
SET2100	10		
SET2120	12		
SET2150	15		

Dimension (Unit: mm)

Materials

Body: ceramic
 End caps: Copper or Silver plated brass
 Fuse element: Alloy wire

Packaging

1,000 pcs per reel

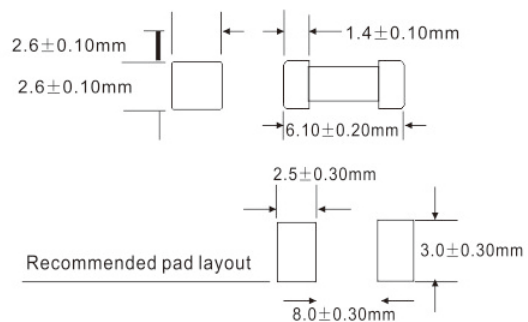

R1032 series, Surface Mount fuse Fast-Acting
32V/63V/ 72V/100V/125V/250V/350V/400V

R1032 series, Surface Mount fuse Time-Lag
32V/63V/ 72V/100V/125V/250V/350V/400V



Description

R1032 Series fast-acting square Surface Mount fuses are ceramic tube/ end cap constructions, RoHS compliant, Halogen Free and lead-free, with U.S. (UL/CSA) safety agency approvals. Provide board level primary and secondary circuit protection in a wide variety of applications, end caps are available in copper or silver plated.

Electrical Characteristics(UL/CSA,248-14) File No.E340427

Ampere Rating	% of current Rating	Blowing Time
0.05A-15A /20A-40A	100%	>4hours
0.05A-15A /20A-40A	200%	< 60 sec

Features

- Lead-Free and RoHS compliant
- Inrush withstand capability
- Wide range of current rating
- Wide range of current rating
- Excellent environmental integrity
- Operating temperature range -55°C to +125°C (consider de-rating)

Applications

- LED driver
- Notebook/Laptops
- PC computer
- Office electronic equipment
- Digital camera
- LCD/LED monitor/TV/backlight inverter
- Networking device
- Telecom device
- Industrial equipment
- Power supply

Catalog Number	Ampere Rating(A)	Voltage Rating(V)	Interrupting Rating
R1032.***	0.050	32V	1000A@32V
	0.062		
	0.080		
	0.100		
	0.125		
	0.200		
	0.250		
	0.300		
	0.375		
	0.400		
R1032F.***	0.500	100V	150A@63V/72/100V/125V
R1032T.***	0.600	125V	50A@350V/400V
	0.630		
	0.700		
	0.750		
	0.800		
	1		
	1.25		
	1.5		
	2		

Catalog Number	Ampere Rating(A)	Voltage Rating(V)	Interrupting Rating
R1032.***	2.5	32V	1000A@32V
	3		
	3.15		
	3.5		
	4		
	5		
	6		
	6.3		
	7		
	7.5		
R1032F.***	8	100V	150A@63V/72/100V/125V
R1032T.***	10	125V	50A@350V/400V
	12		
	15		
	20		
	25		
	30		
	40 *		

Dimension (Unit: mm)

Materials

- Body: ceramic
- End caps: Copper or Silver plated brass
- Fuse element: Alloy wire

Packaging

2,000 pcs per reel

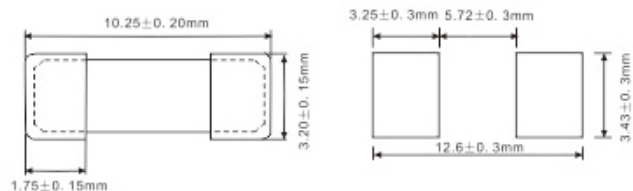

**R1245F series, Surface Mount fuse Fast-Acting
32V/63V/72V/125V/250V**

**R1245T series, Surface Mount fuse Time-Lag
32V/63V/72V/125V/250V**



Description

R1245 Series fast-acting square Surface Mount fuses are ceramic tube/ end cap constructions, RoHS compliant, Halogen Free and lead-free, with U.S. (UL/CSA) safety agency approvals. Provide board level primary and secondary circuit protection in a wide variety of applications, end caps are available in copper or silver plated.

Electrical Characteristics(UL/CSA,248-14) File No.E340427

Ampere Rating	% of current Rating	Blowing Time
15A-100A	100%	>4hours
15A-100A	200%	< 60 sec

Features

- Lead-Free and RoHS compliant
- Inrush withstand capability
- Wide range of current rating
- Wide range of current rating
- Excellent environmental integrity
- Operating temperature range -55°C to +125°C (consider de-rating)

Applications

- LED driver
- Notebook/Laptops
- PC computer
- Office electronic equipment
- Digital camera
- LCD/LED monitor/TV/backlight inverter
- Networking device
- Telecom device
- Industrial equipment
- Power supply

Catalog Number	Ampere Rating(A)	Voltage Rating(V)	Interrupting Rating
R1245F.15	15	32V 63V 72V 125V 250V	200A@250V 500A@125V 1000A@32V /63V/72V
R1245F.20	20		
R1245F.25	25		
R1245F.30	30		
R1245F.40	40 *		
R1245F.50	50 *		
R1245F.60	60 *		
R1245F.80	80 *		
R1245F.100	100 *		

Catalog Number	Ampere Rating(A)	Voltage Rating(V)	Interrupting Rating
R1245T.15	15	32V 63V 72V 125V 250V	200A@250V 500A@125V 1000A@32V /63V/72V
R1245T.20	20		
R1245T.25	25		
R1245T.30	30		
R1245T.40	40 *		
R1245T.50	50 *		
R1245T.60	60 *		
R1245T.80	80 *		
R1245T.100	100 *		

Dimension (Unit: mm)

Materials

Body: ceramic
End caps: Copper or Silver plated brass
Fuse element: Alloy wire

Packaging

1500 pcs per reel

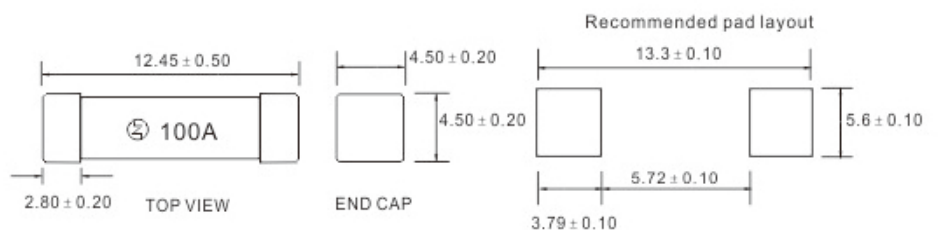

8x4x5mm MFC Series Fast-Acting Radial Lead Micro Fuse



Agency Approvals 安規認證

Agency	Ampere Range	Agency File Number
	50mA~10A	E340427(JDYX2)
	50mA~10A	E340427(JDYX8)
	50mA~10A	Pending
	50mA~10A	Pending
	50mA~10A	Pending
	50mA~10A	Pending

Electrical Characteristics 電氣特性

% of Ampere Rating(In)	Blowing Time
150%* In	(60 min Minimum)
210%* In	(30 min Max)
275%* In	(10 ms~3 s)
400%* In	(3ms~300ms)
1000%* In	(20 ms Max)

Materials 材質

Part Name	Material
Cap&Base	Black/Brown Thermoplastic, UL 94 V-0
Lead wire	Copper, Tin-plated

Packaging 包裝

Packing type	Description
Bulk	1,000PCS per bag
Tape	1,000PCS per box

Catalog Number	Ampere Rating	Voltage Rating	Max Voltage Drop (mv)	I ² T Melting Integral (A ² .S)
MFC0050A	50mA	250/300V	4200	0.0009
MFC0100A	100mA	250/300V	3500	0.002
MFC0125A	125mA	250/300V	2000	0.008
MFC0160A	160mA	250/300V	2000	0.012
MFC0200A	200mA	250/300V	1700	0.04
MFC0250A	250mA	250/300V	1400	0.06
MFC0315A	315mA	250/300V	1300	0.10
MFC0400A	400mA	250/300V	1200	0.20
MFC0500A	500mA	250/300V	1100	0.35
MFC0630A	630mA	250/300V	650	0.50
MFC0800A	800mA	250/300V	240	1.3
MFC1100A	1A	250/300V	200	1.6
MFC1125A	1.25A	250/300V	200	2.4
MFC1160A	1.6A	250/300V	190	4.6
MFC1200A	2A	250/300V	170	7.9
MFC1250A	2.5A	250/300V	170	12
MFC1315A	3.15A	250/300V	150	22
MFC1400A	4A	250/300V	130	29
MFC1500A	5A	250/300V	130	78
MFC1630A	6.3A	250/300V	130	97
MFC1800A	8A	250/300V	100	290
MFC2100A	10A	250/300V	100	430

Dimensions 尺寸

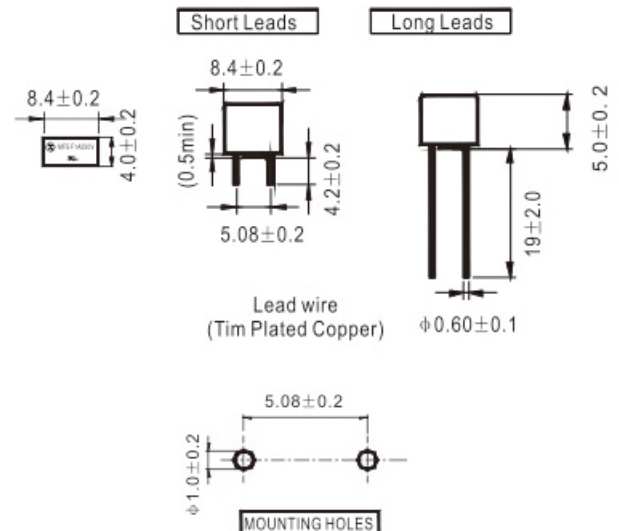

8x4x5mm MTC Series Time-Lag Radial Lead Micro Fuse



Catalog Number	Ampere Rating	Voltage Rating	Max Voltage Drop (mv)	I ² T Melting Integral(A ² .S)
MTC0050A	50mA	250/300V	555	0.02
MTC0100A	100mA	250/300V	355	0.11
MTC0125A	125mA	250/300V	323	0.12
MTC0160A	160mA	250/300V	296	0.17
MTC0200A	200mA	250/300V	272	0.21
MTC0250A	250mA	250/300V	251	0.41
MTC0315A	315mA	250/300V	237	0.63
MTC0400A	400mA	250/300V	211	1.22
MTC0500A	500mA	250/300V	202	2.34
MTC0630A	630mA	250/300V	191	2.88
MTC0800A	800mA	250/300V	172	3.92
MTC1100A	1A	250/300V	200	5.77
MTC1125A	1.25A	250/300V	200	8.34
MTC1160A	1.6A	250/300V	190	13.60
MTC1200A	2A	250/300V	170	25.90
MTC1250A	2.5A	250/300V	170	42
MTC1315A	3.15A	250/300V	150	58
MTC1400A	4A	250/300V	130	92
MTC1500A	5A	250/300V	130	140
MTC1630A	6.3A	250/300V	130	330
MTC1800A	8A	250/300V	100	470
MTC2100A	10A	250/300V	100	620

Agency Approvals 安規認證

Agency	Ampere Range	Agency File Number
UL	50mA~10A	E340427(JDYX2)
C UL US	50mA~10A	E340427(JDYX8)
VDE	50mA~10A	Pending
CQC	50mA~10A	Pending
PS E JET	50mA~10A	Pending
K	50mA~10A	Pending

Electrical Characteristics 電氣特性

% of Ampere Rating(In)	Blowing Time
150%* In	(60 min Minimum)
210%* In	(2 min Max)
275%* In	(400 ms~10 s)
400%* In	(150 ms~3 s)
1000%* In	(20 ms~150 ms)

Materials 材質

Part Name	Material
Cap&Base	Black/Brown Thermoplastic, UL 94 V-0
Lead wire	Copper, Tin-plated

Packaging 包裝

Packing type	Description
Bulk	1,000PCS per bag
Tape	1,000PCS per box

Dimensions 尺寸

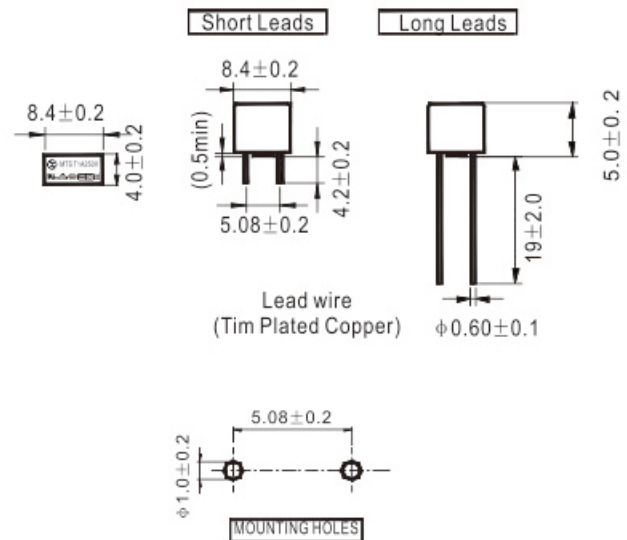

8x4x7mm MFS Series Fast-Acting Radial Lead Micro Fuse

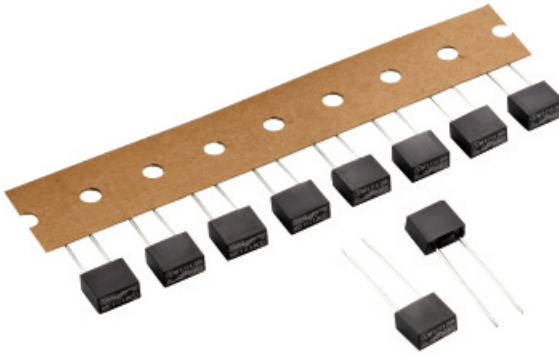

Agency Approvals 安規認證

Agency	Ampere Range	Agency File Number
	50mA ~ 6.3A	E340427(JDYX2)
	50mA ~ 6.3A	E340427(JDYX8)
	50mA ~ 6.3A	Pending
	50mA ~ 6.3A	Pending
	50mA ~ 6.3A	Pending
	50mA ~ 6.3A	Pending

Electrical Characteristics 電氣特性

% of Ampere Rating(In)	Blowing Time
150%* In	(60 min Minimum)
210%* In	(30 min Max)
275%* In	(10 ms~3 s)
400%* In	(3ms~300ms)
1000%* In	(20 ms Max)

Materials 材質

Part Name	Material
Cap&Base	Black/Brown Thermoplastic, UL 94 V-0
Lead wire	Copper, Tin-plated

Packaging 包裝

Packing type	Description
Bulk	1,000PCS per bag
Tape	1,000PCS per box

Catalog Number	Ampere Rating	Voltage Rating	Max Voltage Drop (mv)	I ² T Melting Integral(A ² .S)
MFS0050A	50mA	250V	4200	0.0009
MFS0100A	100mA	250V	3500	0.002
MFS0125A	125mA	250V	2000	0.008
MFS0160A	160mA	250V	2000	0.012
MFS0200A	200mA	250V	1700	0.04
MFS0250A	250mA	250V	1400	0.06
MFS0315A	315mA	250V	1300	0.10
MFS0400A	400mA	250V	1200	0.20
MFS0500A	500mA	250V	1100	0.35
MFS0630A	630mA	250V	650	0.50
MFS0800A	800mA	250V	240	1.3
MFS1100A	1A	250V	200	1.6
MFS1125A	1.25A	250V	200	2.4
MFS1160A	1.6A	250V	190	4.6
MFS1200A	2A	250V	170	7.9
MFS1250A	2.5A	250V	170	12
MFS1315A	3.15A	250V	150	22
MFS1400A	4A	250V	130	29
MFS1500A	5A	250V	130	78
MFS1630A	6.3A	250V	130	97
MFS1800A	8A	250V	100	290
MFS2100A	10A	250V	100	430

Dimensions 尺寸

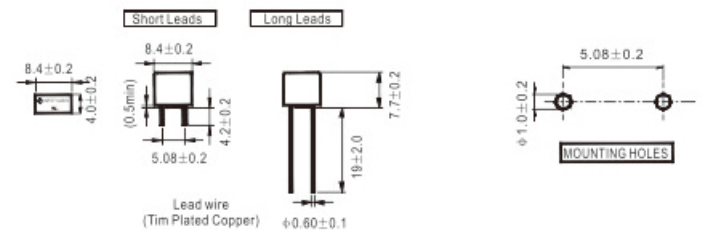
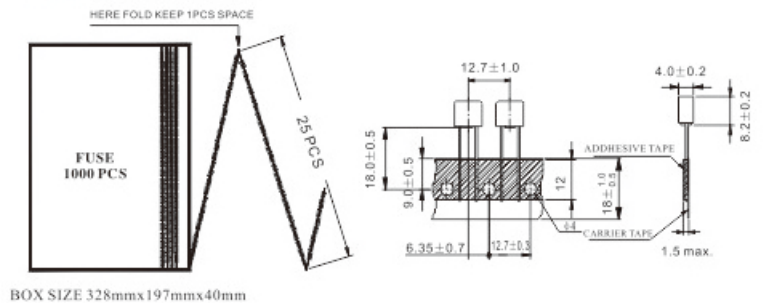

8x4x7mm MTS Series Time-Lag Radial Lead Micro Fuse

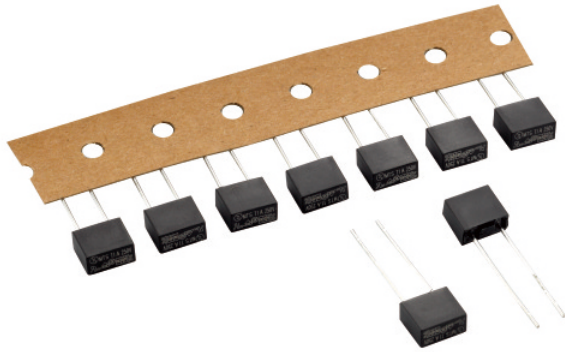

Agency Approvals 安規認證

Agency	Ampere Range	Agency File Number
	50mA ~ 6.3A	E340427(JDYX2)
	50mA ~ 6.3A	E340427(JDYX8)
	50mA ~ 6.3A	40039420
	50mA~6.3A 8A~10A	2019010207239568
	50mA~6.3A	PSE16021073
	50mA~6.3A 200mA 250mA 315mA	SU05052-16004/5/6 SU05052-19004

Electrical Characteristics 電氣特性

% of Ampere Rating(In)	Blowing Time
150%* In	(60 min Minimum)
210%* In	(2 min Max)
275%* In	(400 ms~10 s)
400%* In	(150 ms~3 s)
1000%* In	(20 ms~150 ms)

Materials 材質

Part Name	Material
Cap&Base	Black/Brown Thermoplastic, UL 94 V-0
Lead wire	Copper, Tin-plated

Packaging 包裝

Packing type	Description
Bulk	1,000PCS per bag
Tape	1,000PCS per box

Catalog Number	Ampere Rating	Voltage Rating	Max Voltage Drop (mv)	I ² T Melting Integral(A ² .S)
MTS0050A	50mA	250V	555	0.02
MTS0100A	100mA	250V	355	0.11
MTS0125A	125mA	250V	323	0.12
MTS0160A	160mA	250V	296	0.17
MTS0200A	200mA	250V	272	0.21
MTS0250A	250mA	250V	251	0.41
MTS0315A	315mA	250V	237	0.63
MTS0400A	400mA	250V	211	1.22
MTS0500A	500mA	250V	202	2.34
MTS0630A	630mA	250V	191	2.88
MTS0800A	800mA	250V	172	3.92
MTS1100A	1A	250V	200	5.77
MTS1125A	1.25A	250V	200	8.34
MTS1160A	1.6A	250V	190	13.60
MTS1200A	2A	250V	170	25.90
MTS1250A	2.5A	250V	170	42
MTS1315A	3.15A	250V	150	58
MTS1400A	4A	250V	130	92
MTS1500A	5A	250V	130	140
MTS1630A	6.3A	250V	130	330
MTS1800A	8A	250V	100	470
MTS2100A	10A	250V	100	620

Dimensions 尺寸

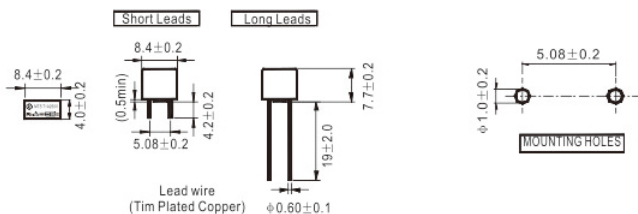
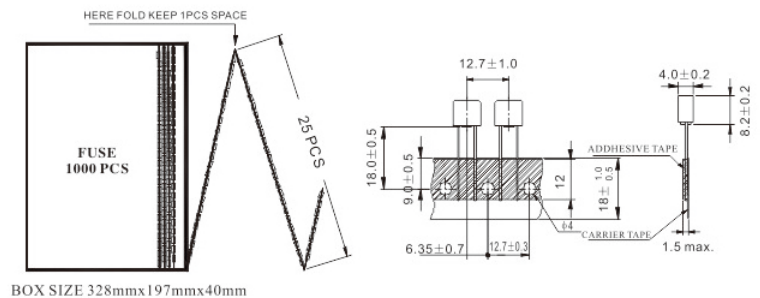

8x4x7mm NFS Series Fast-Acting Radial Lead Micro Fuse

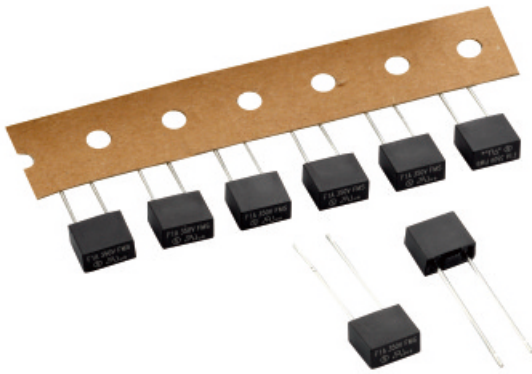

Agency Approvals 安規認證

Agency	Ampere Range	Agency File Number
	50mA ~ 6.3A	E340427(JDYX2)
	50mA ~ 6.3A	E340427(JDYX8)
	50mA ~ 6.3A	Pending
	50mA ~ 6.3A	Pending
	50mA ~ 6.3A	Pending
	50mA ~ 6.3A	Pending

Electrical Characteristics 電氣特性

% of Ampere Rating(In)	Blowing Time
150%* In	(60 min Minimum)
210%* In	(30 min Max)
275%* In	(10 ms~3 s)
400%* In	(3ms~300ms)
1000%* In	(20 ms Max)

Materials 材質

Part Name	Material
Cap&Base	Black/Brown Thermoplastic, UL 94 V-0
Lead wire	Copper, Tin-plated

Packaging 包裝

Packing type	Description
Bulk	1,000PCS per bag
Tape	1,000PCS per box

Catalog Number	Ampere Rating	Voltage Rating	Max Voltage Drop (mv)	I ² T Melting Integral(A ² .S)
NFS0050A	50mA	300V	3600	0.0008
NFS0100A	100mA	300V	3500	0.002
NFS0125A	125mA	300V	2000	0.008
NFS0160A	160mA	300V	2000	0.012
NFS0200A	200mA	300V	1700	0.04
NFS0250A	250mA	300V	1400	0.06
NFS0315A	315mA	300V	1300	0.10
NFS0400A	400mA	300V	1200	0.20
NFS0500A	500mA	300V	1100	0.35
NFS0630A	630mA	300V	650	0.50
NFS0800A	800mA	300V	240	1.3
NFS1100A	1A	300V	200	1.6
NFS1125A	1.25A	300V	200	2.4
NFS1160A	1.6A	300V	190	4.6
NFS1200A	2A	300V	170	7.9
NFS1250A	2.5A	300V	170	12
NFS1315A	3.15A	300V	150	22
NFS1400A	4A	300V	130	29
NFS1500A	5A	300V	130	78
NFS1630A	6.3A	300V	130	97
NFS1800A	8A	300V	100	290
NFS2100A	10A	300V	100	430

Dimensions 尺寸

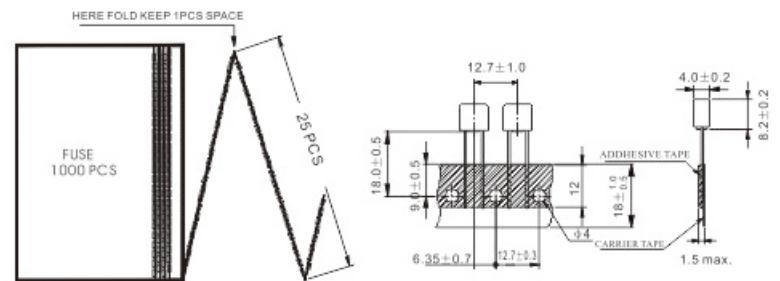

BOX SIZE 328mmx197mmx40mm

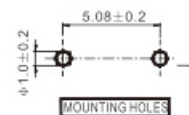
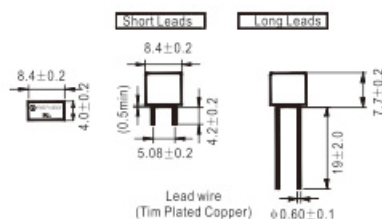

8x4x7mm NTS Series Time-Lag Radial Lead Micro Fuse

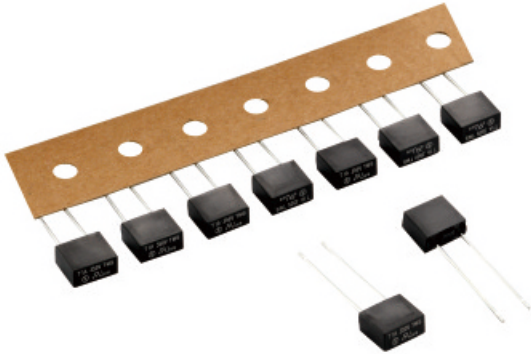

Agency Approvals 安規認證

Agency	Ampere Range	Agency File Number
	50mA ~ 6.3A	E340427(JDYX2)
	50mA ~ 6.3A	E340427(JDYX8)
	50mA ~ 6.3A	Pending
	50mA ~ 6.3A	Pending
	50mA ~ 6.3A	Pending
	50mA ~ 6.3A	Pending

Electrical Characteristics 電氣特性

% of Ampere Rating(In)	Blowing Time
150%* In	(60 min Minimum)
210%* In	(2 min Max)
275%* In	(400 ms~10 s)
400%* In	(150 ms~3 s)
1000%* In	(20 ms~150 ms)

Materials 材質

Part Name	Material
Cap&Base	Black/Brown Thermoplastic, UL 94 V-0
Lead wire	Copper, Tin-plated

Packaging 包裝

Packing type	Description
Bulk	1,000PCS per bag
Tape	1,000PCS per box

Catalog Number	Ampere Rating	Voltage Rating	Max Voltage Drop (mv)	I ² T Melting Integral(A ² .S)
NTS0050A	50mA	300V	655	0.04
NTS0100A	100mA	300V	410	0.31
NTS0125A	125mA	300V	323	0.42
NTS0160A	160mA	300V	296	0.57
NTS0200A	200mA	300V	272	0.71
NTS0250A	250mA	300V	251	0.91
NTS0315A	315mA	300V	237	0.63
NTS0400A	400mA	300V	211	1.22
NTS0500A	500mA	300V	202	2.34
NTS0630A	630mA	300V	191	2.88
NTS0800A	800mA	300V	172	3.92
NTS1100A	1A	300V	200	8.77
NTS1125A	1.25A	300V	200	10.22
NTS1160A	1.6A	300V	190	14.88
NTS1200A	2A	300V	170	29.90
NTS1250A	2.5A	300V	170	47
NTS1315A	3.15A	300V	150	62
NTS1400A	4A	300V	130	104
NTS1500A	5A	300V	130	195
NTS1630A	6.3A	300V	130	378
NTS1800A	8A	300V	100	521
NTS2100A	10A	300V	100	640

Dimensions 尺寸

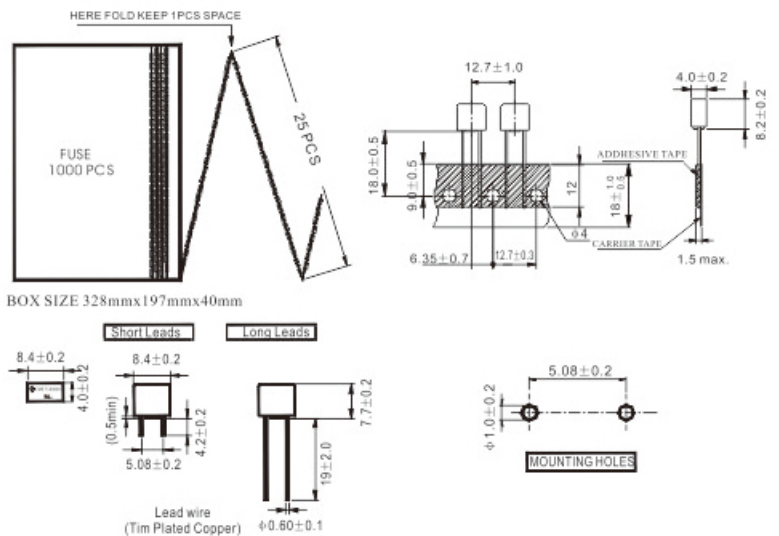

8x4x7mm FMS Series Fast-Acting Radial Lead Micro Fuse

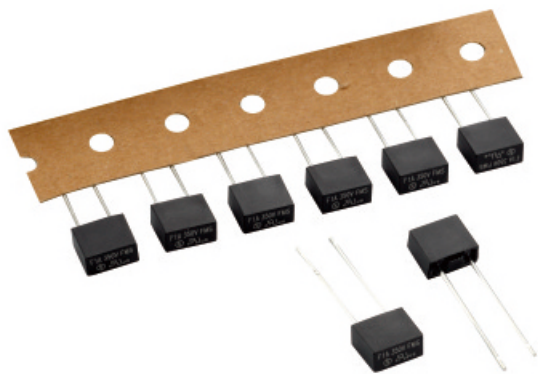

Agency Approvals 安規認證

Agency	Ampere Range	Agency File Number
	50mA ~ 6.3A	E340427(JDYX2)
C RU US	50mA ~ 6.3A	E340427(JDYX8)
	50mA ~ 6.3A	Pending
	50mA ~ 6.3A	Pending
	50mA ~ 6.3A	Pending
	50mA ~ 6.3A	Pending

Electrical Characteristics 電氣特性

% of Ampere Rating(In)	Blowing Time
150%* In	(60 min Minimum)
210%* In	(30 min Max)
275%* In	(10 ms~3 s)
400%* In	(3ms~300ms)
1000%* In	(20 ms Max)

Materials 材質

Part Name	Material
Cap&Base	Black/Brown Thermoplastic, UL 94 V-0
Lead wire	Copper, Tin-plated

Packaging 包裝

Packing type	Description
Bulk	1,000PCS per bag
Tape	1,000PCS per box

Catalog Number	Ampere Rating	Voltage Rating	Max Voltage Drop (mv)	I ² T Melting Integral(A ² .S)
FMS0050A	50mA	350V	3600	0.0008
FMS0100A	100mA	350V	3500	0.002
FMS0125A	125mA	350V	2000	0.008
FMS0160A	160mA	350V	2000	0.012
FMS0200A	200mA	350V	1700	0.04
FMS0250A	250mA	350V	1400	0.06
FMS0315A	315mA	350V	1300	0.10
FMS0400A	400mA	350V	1200	0.20
FMS0500A	500mA	350V	1100	0.35
FMS0630A	630mA	350V	650	0.50
FMS0800A	800mA	350V	240	1.3
FMS1100A	1A	350V	200	1.6
FMS1125A	1.25A	350V	200	2.4
FMS1160A	1.6A	350V	190	4.6
FMS1200A	2A	350V	170	7.9
FMS1250A	2.5A	350V	170	12
FMS1315A	3.15A	350V	150	22
FMS1400A	4A	350V	130	29
FMS1500A	5A	350V	130	78
FMS1630A	6.3A	350V	130	97
FMS1800A	8A	350V	100	290
FMS2100A	10A	350V	100	430

Dimensions 尺寸

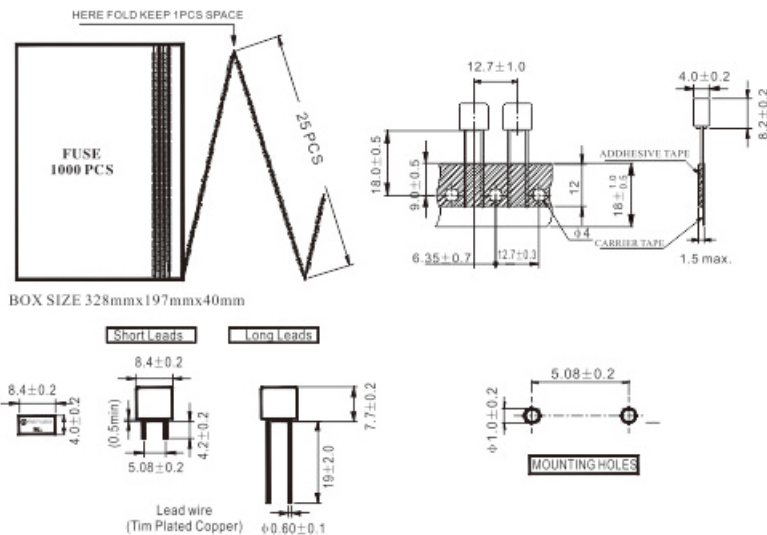

8x4x7mm TMS Series Time-Lag Radial Lead Micro Fuse

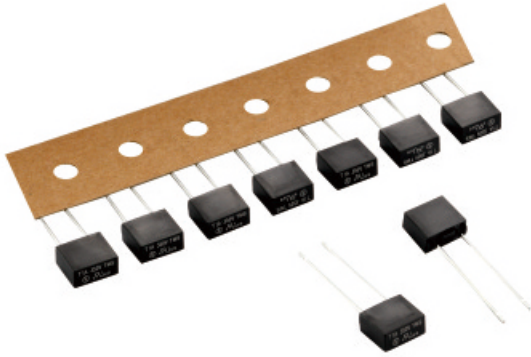

Agency Approvals 安規認證

Agency	Ampere Range	Agency File Number
	50mA ~ 6.3A	E340427(JDYX2)
	50mA ~ 6.3A	E340427(JDYX8)
	50mA ~ 6.3A	Pending
	50mA ~ 6.3A	Pending
	50mA ~ 6.3A	Pending
	50mA ~ 6.3A	Pending

Electrical Characteristics 電氣特性

% of Ampere Rating(In)	Blowing Time
150%* In	(60 min Minimum)
210%* In	(2 min Max)
275%* In	(400 ms~10 s)
400%* In	(150 ms~3 s)
1000%* In	(20 ms~150 ms)

Materials 材質

Part Name	Material
Cap&Base	Black/Brown Thermoplastic, UL 94 V-0
Lead wire	Copper, Tin-plated

Packaging 包裝

Packing type	Description
Bulk	1,000PCS per bag
Tape	1,000PCS per box

Catalog Number	Ampere Rating	Voltage Rating	Max Voltage Drop (mv)	I ² T Melting Integral(A ² .S)
TMS0050A	50mA	350V	655	0.04
TMS0100A	100mA	350V	410	0.31
TMS0125A	125mA	350V	323	0.42
TMS0160A	160mA	350V	296	0.57
TMS0200A	200mA	350V	272	0.71
TMS0250A	250mA	350V	251	0.91
TMS0315A	315mA	350V	237	0.63
TMS0400A	400mA	350V	211	1.22
TMS0500A	500mA	350V	202	2.34
TMS0630A	630mA	350V	191	2.88
TMS0800A	800mA	350V	172	3.92
TMS1100A	1A	350V	200	8.77
TMS1125A	1.25A	350V	200	10.22
TMS1160A	1.6A	350V	190	14.88
TMS1200A	2A	350V	170	29.90
TMS1250A	2.5A	350V	170	47
TMS1315A	3.15A	350V	150	62
TMS1400A	4A	350V	130	104
TMS1500A	5A	350V	130	195
TMS1630A	6.3A	350V	130	378
TMS1800A	8A	350V	100	521
TMS2100A	10A	350V	100	640

Dimensions 尺寸

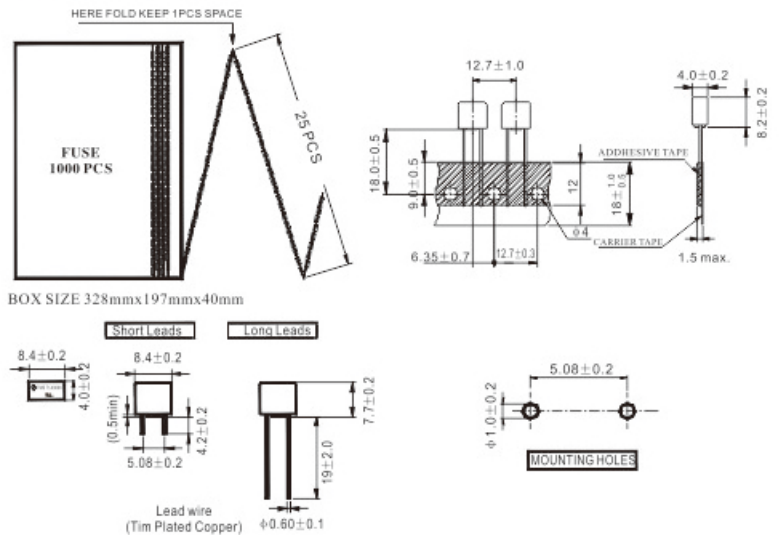

12x6x9mm 96F Series Fast-Acting Radial Lead Micro Fuse

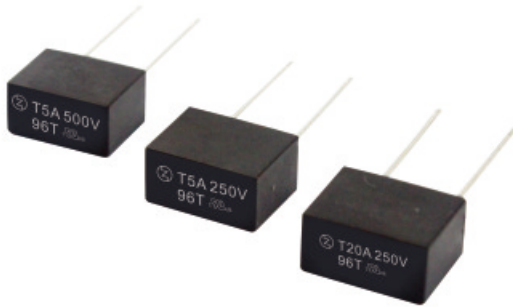

Agency Approvals 安規認證

Agency	Ampere Range	Agency File Number
	50mA~20A	E340427(JDYX2)
	50mA~20A	E340427(JDYX8)
	50mA ~ 6.3A	Pending
	50mA ~ 6.3A	Pending
	50mA ~ 6.3A	Pending
	50mA ~ 6.3A	Pending

Electrical Characteristics 電氣特性

% of Ampere Rating(In)	Blowing Time
150%* In	(60 min Minimum)
210%* In	(30 min Max)
275%* In	(10 ms~3 s)
400%* In	(3ms~300ms)
1000%* In	(20 ms Max)

Materials 材質

Part Name	Material
Cap&Base	Black/Brown Thermoplastic, UL 94 V-0
Lead wire	Copper, Tin-plated

Packaging 包裝

Packing type	Description
Bulk	1,000PCS per bag
Tape	1,000PCS per box

Catalog Number	Ampere Rating	Voltage Rating	Interrupting Rating
96F0050A	50mA	125V	100A@500V
96F0100A	100mA		
96F0125A	125mA		
96F0160A	160mA		
96F0200A	200mA		
96F0250A	250mA		
96F0315A	315mA		
96F0400A	400mA		
96F0500A	500mA		
96F0630A	630mA		
96F0800A	800mA	250V	100A@500V
96F1100A	1A		
96F1125A	1.25A		
96F1160A	1.6A	300V	400A@125V/250V
96F1200A	2A		
96F1250A	2.5A	350V	100A@300V/350V
96F1315A	3.15A		
96F1400A	4A		
96F1500A	5A		
96F1630A	6.3A		
96F1800A	8A		
96F2100A	10A		
96F2120A	12A		
96F2150A	15A		
96F2160A	16A		
96F2200A	20A		

Dimensions 尺寸

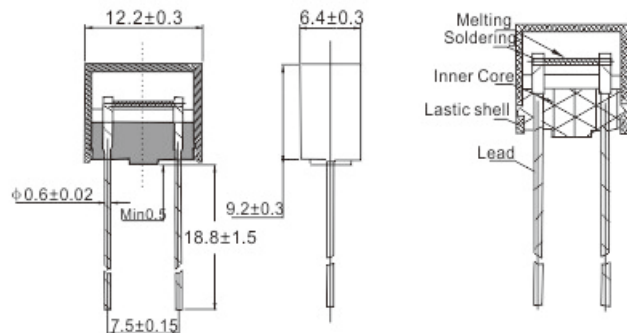

the size chart of product

The structure of product

12x6x9mm 96T Series Time-Lag Radial Lead Micro Fuse

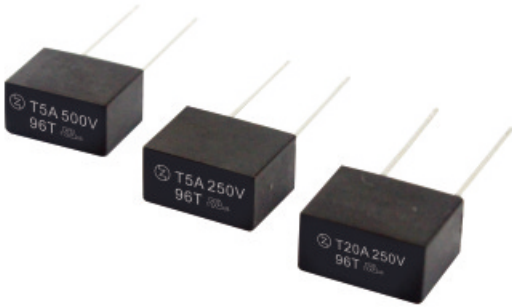

Catalog Number	Ampere Rating	Voltage Rating	Interrupting Rating
96T0050A	50mA	125V	100A@500V
96T0100A	100mA		
96T0125A	125mA		
96T0160A	160mA		
96T0200A	200mA		
96T0250A	250mA		
96T0315A	315mA		
96T0400A	400mA		
96T0500A	500mA		
96T0630A	630mA		
96T0800A	800mA	250V	400A@125V/250V
96T1100A	1A		
96T1125A	1.25A	300V	100A@300V/350V
96T1160A	1.6A		
96T1200A	2A	350V	
96T1250A	2.5A		
96T1315A	3.15A	500V	
96T1400A	4A		
96T1500A	5A		
96T1630A	6.3A		
96T1800A	8A		
96T2100A	10A		
96T2120A	12A		
96T2150A	15A		
96T2160A	16A		
96T2200A	20A		

• Agency Approvals 安規認證

Agency	Ampere Range	Agency File Number
	50mA~20A	E340427(JDYX2)
	50mA~20A	E340427(JDYX8)
	50mA ~ 6.3A	Pending
	50mA ~ 6.3A	Pending
	50mA ~ 6.3A	Pending
	50mA ~ 6.3A	Pending

• Electrical Characteristics 電氣特性

% of Ampere Rating(In)	Blowing Time
150%* In	(60 min Minimum)
210%* In	(2 min Max)
275%* In	(400 ms~10 s)
400%* In	(150 ms~3 s)
1000%* In	(20 ms~150 ms)

• Materials 材質

Part Name	Material
Cap&Base	Black/Brown Thermoplastic, UL 94 V-0
Lead wire	Copper, Tin-plated

• Packaging 包裝

Packing type	Description
Bulk	1,000PCS per bag
Tape	1,000PCS per box

• Dimensions 尺寸

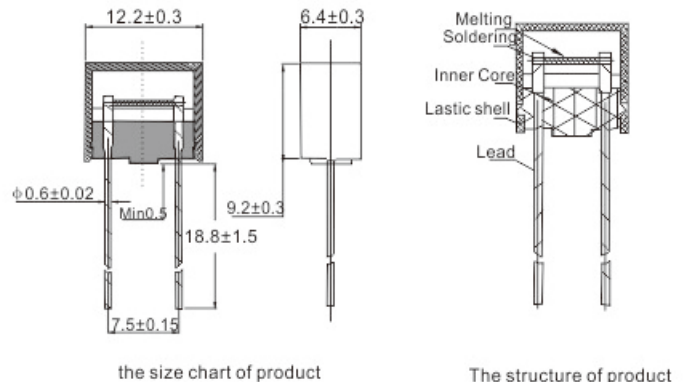

SFB Series 3 x 7mm Fast-Acting Subminiature Fuses



Agency Approvals 安規認證

Agency	Ampere Range	Agency File Number
	100mA ~ 6.3A	E340427(JDYX2)
	100mA ~ 6.3A	E340427(JDYX8)
	100mA ~ 6.3A	Pending
	100mA ~ 6.3A	Pending

Electrical Characteristics 電氣特性

% of Ampere Rating(In)	Blowing Time
100% * In	(4 hours Min)
200% * In	(60 sec Max)

Materials 材質

Part Name	Material
Body Encapsulated	Epoxy Coated
Lead wire	Tin Plated Copper
Cap	Nickel Plated Brass
Fuse element	Alloy wire
Body	Non-Transparent Ceramic Tube

Packaging 包裝

Packing type	Description
Bulk	1,000PCS per bag
Tape	3,000PCS per box

Catalog Number	Ampere Rating	Voltage Rating	Breaking Capacity
SFB0100A/B	100mA	250V/125V	50A@125V/250VAC
SFB0125A/B	125mA	250V/125V	50A@125V/250VAC
SFB0160A/B	160mA	250V/125V	50A@125V/250VAC
SFB0200A/B	200mA	250V/125V	50A@125V/250VAC
SFB0250A/B	250mA	250V/125V	50A@125V/250VAC
SFB0300A/B	300mA	250V/125V	50A@125V/250VAC
SFB0315A/B	315mA	250V/125V	50A@125V/250VAC
SFB0350A/B	350mA	250V/125V	50A@125V/250VAC
SFB0400A/B	400mA	250V/125V	50A@125V/250VAC
SFB0500A/B	500mA	250V/125V	50A@125V/250VAC
SFB0630A/B	630mA	250V/125V	50A@125V/250VAC
SFB0750A/B	750mA	250V/125V	50A@125V/250VAC
SFB0800A/B	800mA	250V/125V	50A@125V/250VAC
SFB1100A/B	1A	250V/125V	50A@125V/250VAC
SFB1125A/B	1.25A	250V/125V	50A@125V/250VAC
SFB1150A/B	1.5A	250V/125V	50A@125V/250VAC
SFB1160A/B	1.6A	250V/125V	50A@125V/250VAC
SFB1200A/B	2A	250V/125V	50A@125V/250VAC
SFB1250A/B	2.5A	250V/125V	50A@125V/250VAC
SFB1300A/B	3A	250V/125V	50A@125V/250VAC
SFB1315A/B	3.15A	250V/125V	50A@125V/250VAC
SFB1350A/B	3.5A	250V/125V	50A@125V/250VAC
SFB1400A/B	4A	250V/125V	50A@125V/250VAC
SFB1500A/B	5A	250V/125V	50A@125V/250VAC
SFB1630A/B	6.3A	250V/125V	50A@125V/250VAC

Dimensions 尺寸

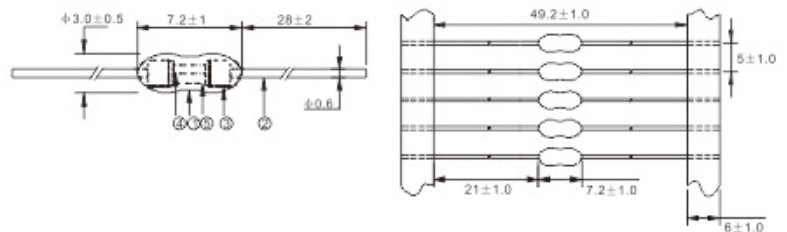

STB Series 3 x 7mm Time-Lag Subminiature Fuses



Agency Approvals 安規認證

Agency	Ampere Range	Agency File Number
	100mA ~ 6.3A	E340427(JDYX2)
	100mA ~ 6.3A	E340427(JDYX8)
	100mA ~ 6.3A	Pending
	100mA ~ 6.3A	Pending

Electrical Characteristics 電氣特性

% of Ampere Rating (In)	Blowing Time
100% * In	(4 hours Min)
200% * In	(60 sec Max)

Materials 材質

Part Name	Material
Body Encapsulated	Epoxy Coated
Lead wire	Tin Plated Copper
Cap	Nickel Plated Brass
Fuse element	Alloy wire
Body	Non-Transparent Ceramic Tube

Packaging 包裝

Packing type	Description
Bulk	1,000PCS per bag
Tape	3,000PCS per box

Catalog Number	Ampere Rating	Voltage Rating	Breaking Capacity
STB0100A/B	100mA	250V/125V	50A@125V/250VAC
STB0125A/B	125mA	250V/125V	50A@125V/250VAC
STB0160A/B	160mA	250V/125V	50A@125V/250VAC
STB0200A/B	200mA	250V/125V	50A@125V/250VAC
STB0250A/B	250mA	250V/125V	50A@125V/250VAC
STB0300A/B	300mA	250V/125V	50A@125V/250VAC
STB0315A/B	315mA	250V/125V	50A@125V/250VAC
STB0350A/B	350mA	250V/125V	50A@125V/250VAC
STB0400A/B	400mA	250V/125V	50A@125V/250VAC
STB0500A/B	500mA	250V/125V	50A@125V/250VAC
STB0630A/B	630mA	250V/125V	50A@125V/250VAC
STB0750A/B	750mA	250V/125V	50A@125V/250VAC
STB0800A/B	800mA	250V/125V	50A@125V/250VAC
STB1100A/B	1A	250V/125V	50A@125V/250VAC
STB1125A/B	1.25A	250V/125V	50A@125V/250VAC
STB1150A/B	1.5A	250V/125V	50A@125V/250VAC
STB1160A/B	1.6A	250V/125V	50A@125V/250VAC
STB1200A/B	2A	250V/125V	50A@125V/250VAC
STB1250A/B	2.5A	250V/125V	50A@125V/250VAC
STB1300A/B	3A	250V/125V	50A@125V/250VAC
STB1315A/B	3.15A	250V/125V	50A@125V/250VAC
STB1350A/B	3.5A	250V/125V	50A@125V/250VAC
STB1400A/B	4A	250V/125V	50A@125V/250VAC
STB1500A/B	5A	250V/125V	50A@125V/250VAC
STB1630A/B	6.3A	250V/125V	50A@125V/250VAC

Dimensions 尺寸

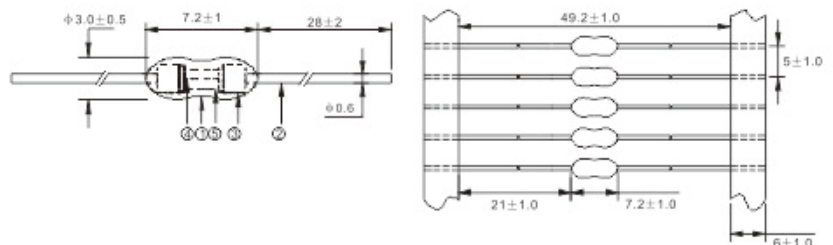

RFP Series 4 x 11mm Fast-Acting Subminiature Fuses



• Agency Approvals 安規認證

Agency	Ampere Range	Agency File Number
	100mA ~ 10A	E340427(JDYX2)
	100mA ~ 10A	E340427(JDYX8)

• Electrical Characteristics 電氣特性

% of Ampere Rating(In)	Blowing Time
100% * In	(4 hours Min)
200% * In	(60 sec Max)

• Materials 材質

Part Name	Material
Body Encapsulated	Epoxy Coated
Lead wire	Tin Plated Copper
Cap	Nickel Plated Brass
Fuse element	Alloy wire
Body	Non-Transparent Ceramic Tube

• Packaging 包裝

Packing type	Description
Bulk	1,000PCS per bag
Tape	2,000PCS per box

Catalog Number	Ampere Rating	Voltage Rating	Breaking Capacity
RFP0100	100mA	350V	50A@350VAC
RFP0125	125mA	350V	50A@350VAC
RFP0160	160mA	350V	50A@350VAC
RFP0200	200mA	350V	50A@350VAC
RFP0250	250mA	350V	50A@350VAC
RFP0300	300mA	350V	50A@350VAC
RFP0315	315mA	350V	50A@350VAC
RFP0350	350mA	350V	50A@350VAC
RFP0375	375mA	350V	50A@350VAC
RFP0400	400mA	350V	50A@350VAC
RFP0500	500mA	350V	50A@350VAC
RFP0600	600mA	350V	50A@350VAC
RFP0630	630mA	350V	50A@350VAC
RFP0700	700mA	350V	50A@350VAC
RFP0750	750mA	350V	50A@350VAC
RFP0800	800mA	350V	50A@350VAC
RFP1100	1A	350V	50A@350VAC
RFP1125	1.25A	350V	50A@350VAC
RFP1150	1.5A	350V	50A@350VAC
RFP1160	1.6A	350V	50A@350VAC
RFP1200	2A	350V	50A@350VAC
RFP1250	2.5A	350V	50A@350VAC
RFP1300	3A	350V	50A@350VAC
RFP1315	3.15A	350V	50A@350VAC
RFP1350	3.5A	350V	50A@350VAC
RFP1400	4A	350V	50A@350VAC
RFP1500	5A	350V	50A@350VAC
RFP1600	6A	350V	50A@350VAC
RFP1630	6.3A	350V	50A@350VAC
RFP1700	7A	350V	50A@350VAC
RFP1800	8A	350V	50A@350VAC
RFP1900	9A	350V	50A@350VAC
RFP2100	10A	350V	50A@350VAC
RFP2120	12A	350V	50A@350VAC
RFP2150	15A	350V	50A@350VAC

• Dimensions 尺寸

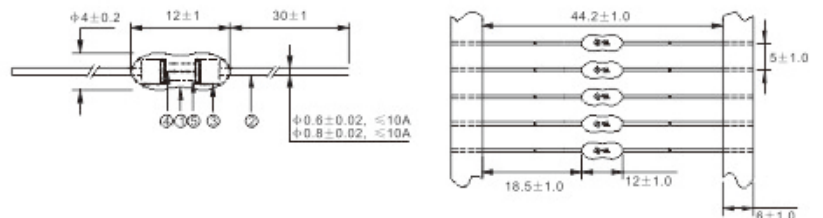

RTP Series 4 x 11mm Time-Lag Subminiature Fuses



• Agency Approvals 安規認證

Agency	Ampere Range	Agency File Number
	100mA ~ 10A	E340427(JDYX2)
	100mA ~ 10A	E340427(JDYX8)

• Electrical Characteristics 電氣特性

% of Ampere Rating(In)	Blowing Time
100% * In	(4 hours Min)
200% * In	(60 sec Max)

• Materials 材質

Part Name	Material
Body Encapsulated	Epoxy Coated
Lead wire	Tin Plated Copper
Cap	Nickel Plated Brass
Fuse element	Alloy wire
Body	Non-Transparent Ceramic Tube

• Packaging 包裝

Packing type	Description
Bulk	1,000PCS per bag
Tape	2,000PCS per box

Catalog Number	Ampere Rating	Voltage Rating	Breaking Capacity
RTP0100	100mA	350V	50A@350VAC
RTP0125	125mA	350V	50A@350VAC
RTP0160	160mA	350V	50A@350VAC
RTP0200	200mA	350V	50A@350VAC
RTP0250	250mA	350V	50A@350VAC
RTP0300	300mA	350V	50A@350VAC
RTP0315	315mA	350V	50A@350VAC
RTP0350	350mA	350V	50A@350VAC
RTP0375	375mA	350V	50A@350VAC
RTP0400	400mA	350V	50A@350VAC
RTP0500	500mA	350V	50A@350VAC
RTP0600	600mA	350V	50A@350VAC
RTP0630	630mA	350V	50A@350VAC
RTP0700	700mA	350V	50A@350VAC
RTP0750	750mA	350V	50A@350VAC
RTP0800	800mA	350V	50A@350VAC
RTP1100	1A	350V	50A@350VAC
RTP1125	1.25A	350V	50A@350VAC
RTP1150	1.5A	350V	50A@350VAC
RTP1160	1.6A	350V	50A@350VAC
RTP1200	2A	350V	50A@350VAC
RTP1250	2.5A	350V	50A@350VAC
RTP1300	3A	350V	50A@350VAC
RTP1315	3.15A	350V	50A@350VAC
RTP1350	3.5A	350V	50A@350VAC
RTP1400	4A	350V	50A@350VAC
RTP1500	5A	350V	50A@350VAC
RTP1600	6A	350V	50A@350VAC
RTP1630	6.3A	350V	50A@350VAC
RTP1700	7A	350V	50A@350VAC
RTP1800	8A	350V	50A@350VAC
RTP1900	9A	350V	50A@350VAC
RTP2100	10A	350V	50A@350VAC
RTP2120	12A	350V	50A@350VAC
RTP2150	15A	350V	50A@350VAC

• Dimensions 尺寸

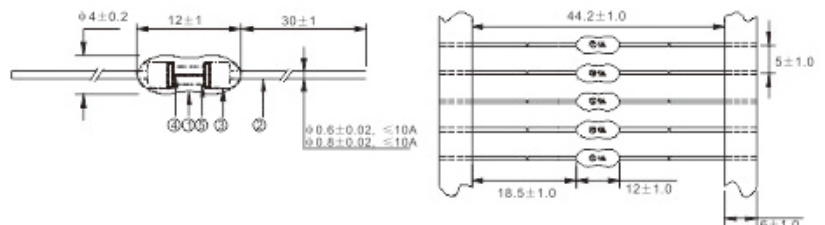

SFP Series 3.6*10mm Fast-Acting Glass Tube Fuse



Agency Approvals 安規認證

Agency	Ampere Range	Agency File Number
	250mA ~ 5A	E340427(JDYX)
	250mA ~ 5A	E340427(JDYX7)
	250mA ~ 5A	Pending
	250mA ~ 5A	Pending

Electrical Characteristics 電氣特性

% of Ampere Rating(In)	Blowing Time
100%* In	(4 hours Min)
200%* In	(60 sec Max)

Materials 材質

Part Name	Material
Cap	Nickel Plated Brass
Body	Glass Tube
Fuse element	Alloy
Lead wire	Tin Plated Copper

Packaging 包裝

Packing type	Description
Bulk	500PCS per bag
Tape	1,000PCS per box

Catalog Number	Ampere Rating	Voltage Rating	Breaking Capacity	i ² T Melting Integral(A ² .S)
SFP0100A/B	100mA	250V/125V	50A@125V/250VAC	0.0015
SFP0125A/B	125mA	250V/125V	50A@125V/250VAC	0.0025
SFP0160A/B	160mA	250V/125V	50A@125V/250VAC	0.0042
SFP0200A/B	200mA	250V/125V	50A@125V/250VAC	0.0065
SFP0250A/B	250mA	250V/125V	50A@125V/250VAC	0.010
SFP0300A/B	300mA	250V/125V	50A@125V/250VAC	0.018
SFP0315A/B	315mA	250V/125V	50A@125V/250VAC	0.020
SFP0350A/B	350mA	250V/125V	50A@125V/250VAC	0.025
SFP0400A/B	400mA	250V/125V	50A@125V/250VAC	0.035
SFP0500A/B	500mA	250V/125V	50A@125V/250VAC	0.060
SFP0630A/B	630mA	250V/125V	50A@125V/250VAC	0.150
SFP0750A/B	750mA	250V/125V	50A@125V/250VAC	0.350
SFP0800A/B	800mA	250V/125V	50A@125V/250VAC	0.5
SFP1100A/B	1A	250V/125V	50A@125V/250VAC	0.6
SFP1125A/B	1.25A	250V/125V	50A@125V/250VAC	1.2
SFP1150A/B	1.5A	250V/125V	50A@125V/250VAC	1.6
SFP1160A/B	1.6A	250V/125V	50A@125V/250VAC	1.8
SFP1200A/B	2A	250V/125V	50A@125V/250VAC	2.4
SFP1250A/B	2.5A	250V/125V	50A@125V/250VAC	3.2
SFP1300A/B	3A	250V/125V	50A@125V/250VAC	6.0
SFP1315A/B	3.15A	250V/125V	50A@125V/250VAC	7.0
SFP1350A/B	3.5A	250V/125V	50A@125V/250VAC	7.5
SFP1400A/B	4A	250V/125V	50A@125V/250VAC	8.0
SFP1500A/B	5A	250V/125V	50A@125V/250VAC	15
SFP1600A/B	6A	250V/125V	50A@125V/250VAC	24
SFP1630A/B	6.3A	250V/125V	50A@125V/250VAC	28
SFP1700A/B	7A	250V/125V	50A@125V/250VAC	36
SFP1800A/B	8A	250V/125V	50A@125V/250VAC	40
SFP2100A/B	10A	250V/125V	50A@125V/250VAC	68

Dimensions 尺寸

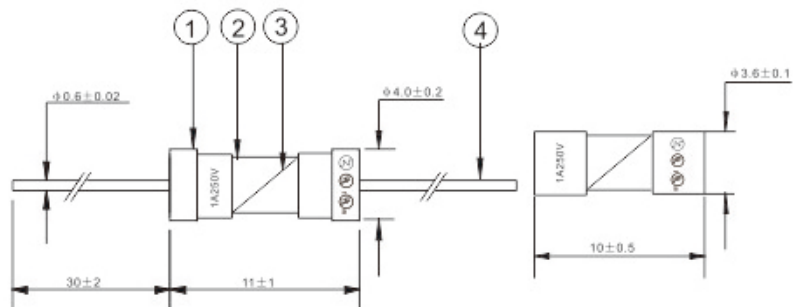

STP Series 3.6*10mm Time-Lag Glass Tube Fuse



Catalog Number	Ampere Rating	Voltage Rating	Breaking Capacity	I ² T Melting Integral(A ² .S)
STP0100A/B	100mA	250V/125V	50A@125V/250VAC	0.0042
STP0125A/B	125mA	250V/125V	50A@125V/250VAC	0.010
STP0160A/B	160mA	250V/125V	50A@125V/250VAC	0.025
STP0200A/B	200mA	250V/125V	50A@125V/250VAC	0.035
STP0250A/B	250mA	250V/125V	50A@125V/250VAC	0.056
STP0300A/B	300mA	250V/125V	50A@125V/250VAC	0.10
STP0315A/B	315mA	250V/125V	50A@125V/250VAC	0.12
STP0350A/B	350mA	250V/125V	50A@125V/250VAC	0.15
STP0400A/B	400mA	250V/125V	50A@125V/250VAC	0.25
STP0500A/B	500mA	250V/125V	50A@125V/250VAC	0.35
STP0630A/B	630mA	250V/125V	50A@125V/250VAC	0.55
STP0750A/B	750mA	250V/125V	50A@125V/250VAC	0.70
STP0800A/B	800mA	250V/125V	50A@125V/250VAC	1.1
STP1100A/B	1A	250V/125V	50A@125V/250VAC	2
STP1125A/B	1.25A	250V/125V	50A@125V/250VAC	3.8
STP1150A/B	1.5A	250V/125V	50A@125V/250VAC	4.2
STP1160A/B	1.6A	250V/125V	50A@125V/250VAC	6.2
STP1200A/B	2A	250V/125V	50A@125V/250VAC	13
STP1250A/B	2.5A	250V/125V	50A@125V/250VAC	18
STP1300A/B	3A	250V/125V	50A@125V/250VAC	28
STP1315A/B	3.15A	250V/125V	50A@125V/250VAC	32
STP1350A/B	3.5A	250V/125V	50A@125V/250VAC	39
STP1400A/B	4A	250V/125V	50A@125V/250VAC	43
STP1500A/B	5A	250V/125V	50A@125V/250VAC	58
STP1600A/B	6A	250V/125V	50A@125V/250VAC	70
STP1630A/B	6.3A	250V/125V	50A@125V/250VAC	81
STP1700A/B	7A	250V/125V	50A@125V/250VAC	102
STP1800A/B	8A	250V/125V	50A@125V/250VAC	131
STP2100A/B	10A	250V/125V	50A@125V/250VAC	158

Agency Approvals 安規認證

Agency	Ampere Range	Agency File Number
UL	250mA ~ 5A	E340427(JDYX)
cUL US	250mA ~ 5A	E340427(JDYX7)
JET	250mA ~ 5A	Pending
KE	250mA ~ 5A	Pending

Electrical Characteristics 電氣特性

% of Ampere Rating(In)	Blowing Time
100%* In	(4 hours Min)
200%* In	(60 sec Max)

Materials 材質

Part Name	Material
Cap	Nickel Plated Brass
Body	Glass Tube
Fuse element	Alloy
Lead wire	Tin Plated Copper

Packaging 包裝

Packing type	Description
Bulk	500PCS per bag
Tape	1,000PCS per box

Dimensions 尺寸

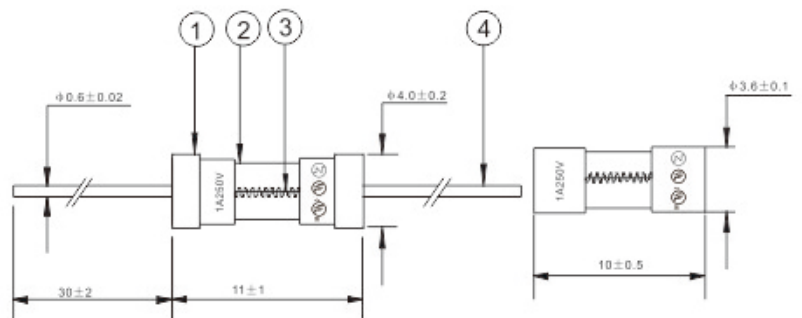

FBP Series 3.6*10mm Fast-Acting Glass Tube Fuse

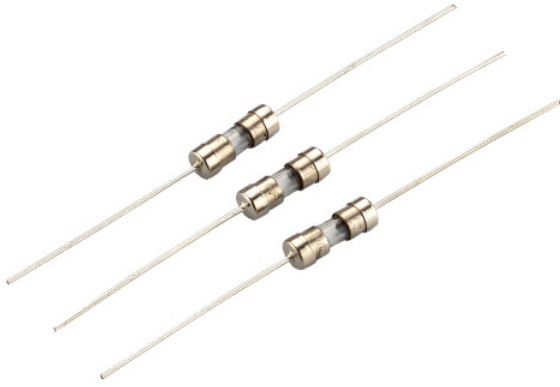

Agency Approvals 安規認證

Agency	Ampere Range	Agency File Number
	250mA ~ 5A	E340427(JDYX)
	250mA ~ 5A	E340427(JDYX7)
	250mA ~ 5A	2019010207239566
	1A, 2A, 3.15A	40034581
	250mA ~ 5 A	Pending

Electrical Characteristics 電氣特性

% of Ampere Rating(In)	Blowing Time
210%* In	(30 min Max)
275%* In	(10 ms~3 s)
400%* In	(3 ms~300 ms)
1000%* In	(20 ms Max)

Materials 材質

Part Name	Material
Cap	Nickel Plated Brass
Body	Glass Tube
Fuse element	Alloy
Lead wire	Tin Plated Copper

Packaging 包裝

Packing type	Description
Bulk	500PCS per bag
Tape	1,000PCS per box

Catalog Number	Ampere Rating	Voltage Rating	Max Voltage Drop (mv)	I ² T Melting Integral(A ² .S)
FBP0050A/B	50mA	250V/125V	850	0.0003
FBP0063A/B	63mA	250V/125V	750	0.0007
FBP0080A/B	80mA	250V/125V	650	0.0009
FBP0100A/B	100mA	250V/125V	600	0.0022
FBP0125A/B	125mA	250V/125V	550	0.0064
FBP0160A/B	160mA	250V/125V	500	0.0090
FBP0200A/B	200mA	250V/125V	480	0.015
FBP0250A/B	250mA	250V/125V	440	0.02
FBP0315A/B	315mA	250V/125V	400	0.03
FBP0400A/B	400mA	250V/125V	370	0.05
FBP0500A/B	500mA	250V/125V	350	0.20
FBP0630A/B	630mA	250V/125V	320	0.3
FBP0800A/B	800mA	250V/125V	300	0.7
FBP1100A/B	1A	250V/125V	280	0.8
FBP1125A/B	1.25A	250V/125V	280	2.4
FBP1160A/B	1.6A	250V/125V	250	3.5
FBP1200A/B	2A	250V/125V	240	3.9
FBP1250A/B	2.5A	250V/125V	200	4.7
FBP1315A/B	3.15A	250V/125V	180	10.8
FBP1400A/B	4A	250V/125V	180	13.9
FBP1500A/B	5A	250V/125V	150	25.4
FBP1630A/B	6.3A	250V/125V	137	31
FBP1800A/B	8A	250V/125V	124	49
FBP2100A/B	10A	250V/125V	110	65
FBP2160A/B	16A	250V/125V	88	87
FBP2200A/B	20A	250V/125V	80	124

Dimensions 尺寸

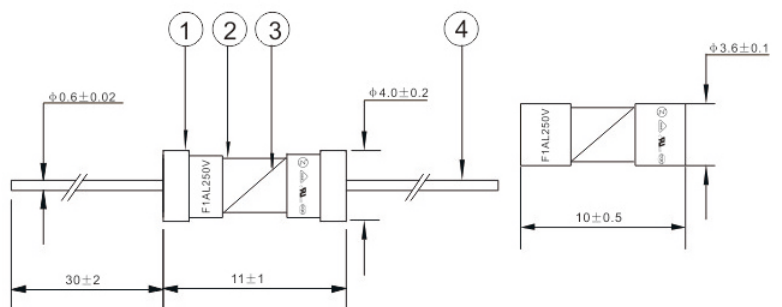

TBP Series 3.6*10mm Time-Lag Glass Tube Fuse



2019010207239568

Agency Approvals 安規認證

Agency	Ampere Range	Agency File Number
	250mA ~ 5A	E340427(JDYX)
	250mA ~ 5A	E340427(JDYX7)
	250mA ~ 5A	2019010207239564
	500mA, 1A, 1.25A, 1.6A, 2A, 2.5A, 3.15A, 5A	40032053

Electrical Characteristics 電氣特性

% of Ampere Rating(In)	Blowing Time
210%*In	(2 min Max)
275%*In	(400 ms~10 s)
400%*In	(150 ms~3 s)
1000%*In	(20 ms~150 ms)

Materials 材質

Part Name	Material
Cap	Nickel Plated Brass
Body	Glass Tube
Fuse element	Alloy
Lead wire	Tin Plated Copper

Packaging 包裝

Packing type	Description
Bulk	500PCS per bag
Tape	1,000PCS per box

Catalog Number	Ampere Rating	Voltage Rating	Max Voltage Drop (mv)	I ² T Melting Integral(A ² .S)
TBP0100A/B	100mA	250V/125V	350	0.003
TBP0125A/B	125mA	250V/125V	300	0.008
TBP0160A/B	160mA	250V/125V	280	0.01
TBP0200A/B	200mA	250V/125V	260	0.04
TBP0250A/B	250mA	250V/125V	240	0.06
TBP0315A/B	315mA	250V/125V	220	0.09
TBP0400A/B	400mA	250V/125V	200	0.2
TBP0500A/B	500mA	250V/125V	190	0.4
TBP0630A/B	630mA	250V/125V	180	1.0
TBP0800A/B	800mA	250V/125V	160	1.9
TBP1100A/B	1A	250V/125V	140	4.2
TBP1125A/B	1.25A	250V/125V	130	8.7
TBP1160A/B	1.6A	250V/125V	120	10.1
TBP1200A/B	2A	250V/125V	100	20.3
TBP1250A/B	2.5A	250V/125V	100	40
TBP1315A/B	3.15A	250V/125V	100	68
TBP1400A/B	4A	250V/125V	100	100
TBP1500A/B	5A	250V/125V	100	133
TBP1630A/B	6.3A	250V/125V	100	172
TBP1800A/B	8A	250V/125V	92	196
TBP2100A/B	10A	250V/125V	90	224
TBP2120A/B	12A	250V/125V	86	270
TBP2160A/B	16A	250V/125V	80	304
TBP2200A/B	20A	250V/125V	78	340

Dimensions 尺寸

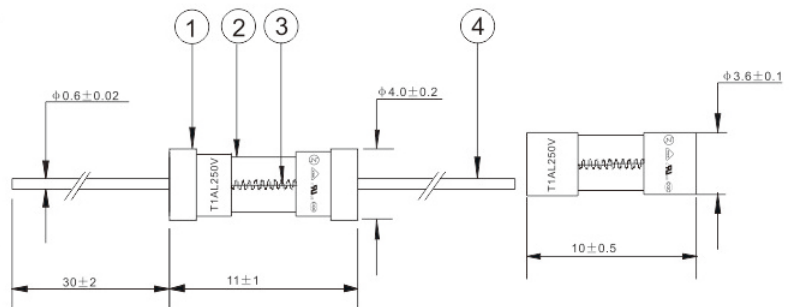

SFC Series 5*20mm Fast-Acting Glass Tube Fuse



Agency Approvals 安規認證

Agency	Ampere Range	Agency File Number
	200mA ~ 10A	E340427(JDYX)
	200mA ~ 10A	E340427(JDYX7)
	200mA ~ 10A	Pending
	200mA ~ 10A	Pending

Electrical Characteristics 電氣特性

% of Ampere Rating(In)	Blowing Time
100%* In	(4 hours Min)
135%* In	(1 hour Max)
200%* In	(5 sec Max)

Materials 材質

Part Name	Material
Cap	Nickel Plated Brass
Body	Glass Tube
Fuse element	Alloy
Lead wire	Tin Plated Copper

Packaging 包裝

Packing type	Description
Bulk	500PCS per bag
Box	5,000PCS per box

Catalog Number	Ampere Rating	Voltage Rating	Breaking Capacity	I ² T Melting Integral(A ² .S)
SFC0100A/B	100mA	250V/125V	10000A@125 V AC (200mA~10A); 35A@250V AC (200mA~1A); 100A@250V AC (1.25A~3.5A); 200A@250V AC (4A~10A).	0.002
SFC0125A/B	125mA	250V/125V		0.003
SFC0160A/B	160mA	250V/125V		0.005
SFC0200A/B	200mA	250V/125V		0.01
SFC0250A/B	250mA	250V/125V		0.02
SFC0300A/B	300mA	250V/125V		0.04
SFC0315A/B	315mA	250V/125V		0.045
SFC0350A/B	350mA	250V/125V		0.055
SFC0400A/B	400mA	250V/125V		0.07
SFC0500A/B	500mA	250V/125V		0.1
SFC0630A/B	630mA	250V/125V		0.2
SFC0750A/B	750mA	250V/125V		0.35
SFC0800A/B	800mA	250V/125V		0.45
SFC1100A/B	1A	250V/125V		0.9
SFC1125A/B	1.25A	250V/125V		1.3
SFC1150A/B	1.5A	250V/125V		1.6
SFC1160A/B	1.6A	250V/125V		2.5
SFC1200A/B	2A	250V/125V		5.8
SFC1250A/B	2.5A	250V/125V		7.6
SFC1300A/B	3A	250V/125V		8.1
SFC1315A/B	3.15A	250V/125V		11
SFC1350A/B	3.5A	250V/125V		19
SFC1400A/B	4A	250V/125V		28
SFC1500A/B	5A	250V/125V		40
SFC1600A/B	6A	250V/125V		50
SFC1630A/B	6.3A	250V/125V		64
SFC1700A/B	7A	250V/125V		107
SFC1800A/B	8A	250V/125V		133
SFC2100A/B	10A	250V/125V		242
SFC2120A/B	12A	250V/125V		268
SFC2150A/B	15A	250V/125V		287
SFC2160A/B	16A	250V/125V		302
SFC2200A/B	20A	250V/125V		347
SFC2250A/B	25A	250V/125V	390	
SFC2300A/B	30A	250V/125V	435	

Dimensions 尺寸

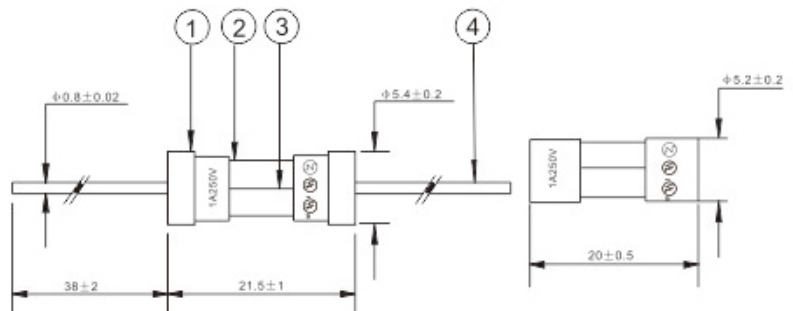

STC Series 5*20mm Time-Lag Glass Tube Fuse



Catalog Number	Ampere Rating	Voltage Rating	Breaking Capacity	I ² T Melting Integral(A ² .S)
STC0100A/B	100mA	250V/125V	10000A@125 V AC (200mA~10A);	0.005
STC0125A/B	125mA	250V/125V		0.01
STC0160A/B	160mA	250V/125V		0.02
STC0200A/B	200mA	250V/125V		0.04
STC0250A/B	250mA	250V/125V		0.06
STC0300A/B	300mA	250V/125V		0.08
STC0315A/B	315mA	250V/125V		0.10
STC0350A/B	350mA	250V/125V		0.13
STC0400A/B	400mA	250V/125V		0.19
STC0500A/B	500mA	250V/125V		0.32
STC0630A/B	630mA	250V/125V	0.54	
STC0750A/B	750mA	250V/125V	35A@250V AC (200mA~1A);	0.93
STC0800A/B	800mA	250V/125V		1.16
STC1100A/B	1A	250V/125V	100A@250V AC (1.25A~3.5A);	2.5
STC1125A/B	1.25A	250V/125V		4.2
STC1150A/B	1.5A	250V/125V		6.2
STC1160A/B	1.6A	250V/125V	200A@250V AC (4A~10A).	11
STC1200A/B	2A	250V/125V		20
STC1250A/B	2.5A	250V/125V		39
STC1300A/B	3A	250V/125V		64
STC1315A/B	3.15A	250V/125V		69
STC1350A/B	3.5A	250V/125V		70
STC1400A/B	4A	250V/125V		83
STC1500A/B	5A	250V/125V		90
STC1600A/B	6A	250V/125V		102
STC1630A/B	6.3A	250V/125V		126
STC1700A/B	7A	250V/125V	129	
STC1800A/B	8A	250V/125V	147	
STC2100A/B	10A	250V/125V	221	
STC2120A/B	12A	250V/125V	240	
STC2150A/B	15A	250V/125V	287	
STC2160A/B	16A	250V/125V	305	
STC2200A/B	20A	250V/125V	336	
STC2250A/B	25A	250V/125V	362	
STC2300A/B	30A	250V/125V	400	

Agency Approvals 安規認證

Agency	Ampere Range	Agency File Number
	200mA ~ 10A	E340427(JDYX)
	200mA ~ 10A	E340427(JDYX7)
	200mA ~ 10A	Pending
	200mA ~ 10A	Pending

Electrical Characteristics 電氣特性

% of Ampere Rating(In)	Blowing Time
100%* In	(4 hours Min)
135%* In	(1 hour Max)
200%* In	(120 sec Max)

Materials 材質

Part Name	Material
Cap	Nickel Plated Brass
Body	Glass Tube
Fuse element	Alloy
Lead wire	Tin Plated Copper

Packaging 包裝

Packing type	Description
Bulk	500PCS per bag
Box	5,000PCS per box

Dimensions 尺寸

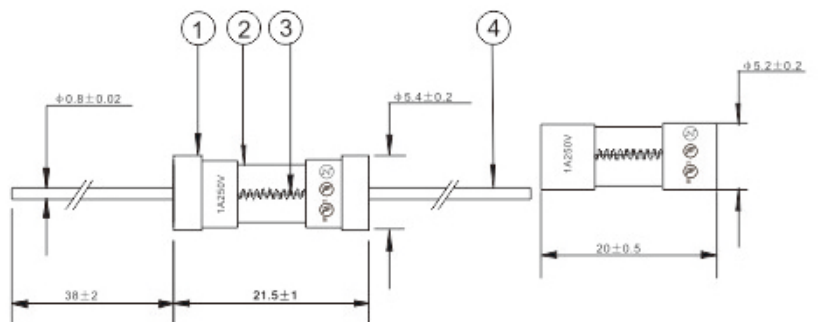

FBC Series 5*20mm Fast-Acting Glass Tube Fuse



Agency Approvals 安規認證

Agency	Ampere Range	Agency File Number
	200mA ~ 10A	E340427(JDYX2)
	200mA ~ 10A	E340427(JDYX8)
	200mA ~ 10A	2016010207899509
	1A, 2A, 3.15A	40037392
	1A, 2A, 3.15A	PSE16021072
	1A, 2A, 3.15A	SU05052-16003/16007

Electrical Characteristics 電氣特性

% of Ampere Rating(In)	Blowing Time (200mA-6.3A)	Blowing Time (8A-10A)
210%* In	(30 min Max)	(30 min Max)
275%* In	(50 ms~2 s)	(50 ms~2 s)
400%* In	(10 ms~300 ms)	(10 ms~400 ms)
1000%* In	(20 ms Max)	(40 ms Max)

Materials 材質

Part Name	Material
Cap	Nickel Plated Brass
Body	Glass Tube
Fuse element	Alloy
Lead wire	Tin Plated Copper

Packaging 包裝

Packing type	Description
Bulk	500PCS per bag
Box	5,000PCS per box

Catalog Number	Ampere Rating	Voltage Rating	Max Voltage Drop (mv)	i ² T Melting Integral(A ² .S)
FBC0100A/B	100mA	250V/125V	3500	0.0005
FBC0125A/B	125mA	250V/125V	2000	0.003
FBC0160A/B	160mA	250V/125V	2000	0.01
FBC0200A/B	200mA	250V/125V	1700	0.04
FBC0250A/B	250mA	250V/125V	1400	0.06
FBC0315A/B	315mA	250V/125V	1300	0.10
FBC0400A/B	400mA	250V/125V	1200	0.20
FBC0500A/B	500mA	250V/125V	1100	0.35
FBC0630A/B	630mA	250V/125V	650	0.50
FBC0800A/B	800mA	250V/125V	240	1.3
FBC1100A/B	1A	250V/125V	200	1.6
FBC1125A/B	1.25A	250V/125V	200	2.4
FBC1160A/B	1.6A	250V/125V	190	4.6
FBC1200A/B	2A	250V/125V	170	7.9
FBC1250A/B	2.5A	250V/125V	170	12
FBC1315A/B	3.15A	250V/125V	150	22
FBC1400A/B	4A	250V/125V	130	29
FBC1500A/B	5A	250V/125V	130	78
FBC1630A/B	6.3A	250V/125V	130	97
FBC1800A/B	8A	250V/125V	100	290
FBC2100A/B	10A	250V/125V	100	430
FBC2125A/B	12.5A	250V/125V	94	510
FBC2160A/B	16A	250V/125V	90	580
FBC2200A/B	20A	250V/125V	88	640
FBC2250A/B	25A	250V/125V	85	720
FBC2300A/B	30A	250V/125V	80	800

Dimensions 尺寸

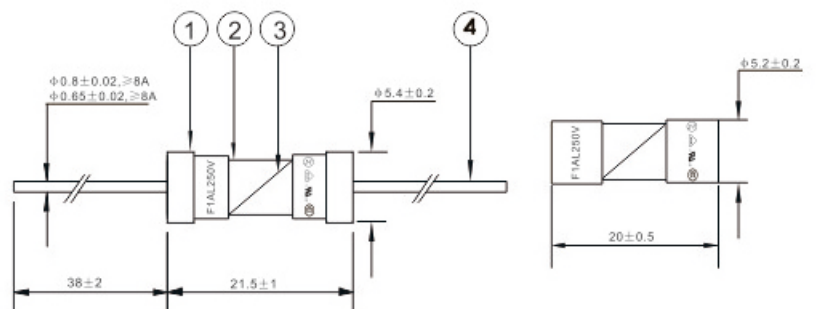

TBC Series 5*20mm Time-Lag Glass Tube Fuse



Agency Approvals 安規認證

Agency	Ampere Range	Agency File Number
	200mA ~ 10A	E340427(JDYX2)
	200mA ~ 10A	E340427(JDYX8)
	200mA ~ 10A	2016010207899506
	1A,2A,3.15A,5A,6.3A	40037363
	1A,2A,3.15A,5A,6.3A	PSE16021071 PSE16021074
	1A,2A,3.15A,5A,6.3A	SU05052-16002/16001

Electrical Characteristics 電氣特性

% of Ampere Rating(In)	Blowing Time (200mA-10A)	Blowing Time (12.5A-16A)
210%* In	(2 min Max)	(5 min Max)
275%* In	(600 ms~10 s)	(600 ms~15 s)
400%* In	(150 ms~3 s)	(150 ms~5 s)
1000%* In	(20 ms~300 ms)	(20 ms~400 ms)

Materials 材質

Part Name	Material
Cap	Nickel Plated Brass
Body	Glass Tube
Fuse element	Alloy
Lead wire	Tin Plated Copper

Packaging 包裝

Packing type	Description
Bulk	500PCS per bag
Box	5,000PCS per box

Catalog Number	Ampere Rating	Voltage Rating	Max Voltage Drop (mv)	I ² T Melting Integral(A ² .S)
TBC0100A/B	100mA	250V/125V	2500	0.004
TBC0125A/B	125mA	250V/125V	2000	0.02
TBC0160A/B	160mA	250V/125V	1900	0.08
TBC0200A/B	200mA	250V/125V	1500	0.1
TBC0250A/B	250mA	250V/125V	1300	0.18
TBC0315A/B	315mA	250V/125V	1100	0.3
TBC0400A/B	400mA	250V/125V	1000	0.65
TBC0500A/B	500mA	250V/125V	900	0.85
TBC0630A/B	630mA	250V/125V	300	1.6
TBC0800A/B	800mA	250V/125V	250	2.3
TBC1100A/B	1A	250V/125V	150	3.5
TBC1125A/B	1.25A	250V/125V	150	4.3
TBC1160A/B	1.6A	250V/125V	150	7.2
TBC1200A/B	2A	250V/125V	150	10
TBC1250A/B	2.5A	250V/125V	120	22
TBC1315A/B	3.15A	250V/125V	100	39
TBC1400A/B	4A	250V/125V	100	54
TBC1500A/B	5A	250V/125V	100	115
TBC1630A/B	6.3A	250V/125V	100	200
TBC1800A/B	8A	250V/125V	100	320
TBC2100A/B	10A	250V/125V	100	510
TBC2125A/B	12.5A	250V/125V	80	800
TBC2160A/B	16A	250V/125V	80	1105
TBC2200A/B	20A	250V/125V	80	1325
TBC2250A/B	25A	250V/125V	78	1700
TBC2300A/B	30A	250V/125V	75	2000

Dimensions

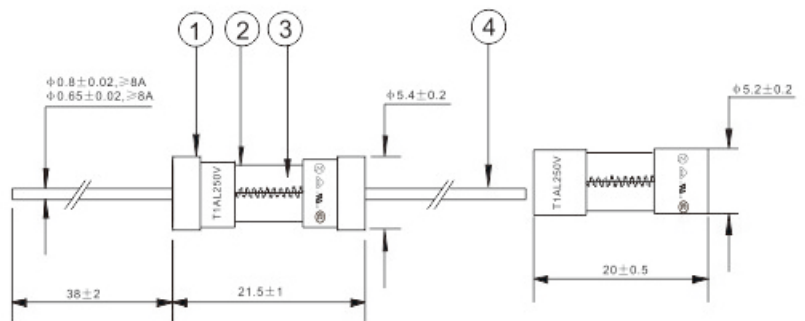

MFC Series 6*32mm Fast-Acting Glass Tube Fuse



Agency Approvals 安規認證

Agency	Ampere Range	Agency File Number
UL	100mA ~ 30A	Pending
C UL US	100mA ~ 30A	E340427(JDYX8)
PS JET	100mA ~ 30A	Pending
KE	100mA ~ 30A	Pending

Electrical Characteristics 電氣特性

% of Ampere Rating(In)	Blowing Time
100%* In	(4 hours Min)
135%* In	(1 hour Max)
200%* In	(5 sec Max)

Materials 材質

Part Name	Material
Cap	Nickel Plated Brass
Body	Glass Tube
Fuse element	Alloy
Lead wire	Tin Plated Copper

Packaging 包裝

Packing type	Description
Bulk	200PCS per bag
Box	4,000PCS per box

Catalog Number	Ampere Rating	Voltage Rating	Breaking Capacity	I ² T Melting Integral(A ² .S)
MFC0100A/B	100mA	250V/125V	0000A@125 V AC (100mA~10A);	0.003
MFC0160A/B	160mA	250V/125V		0.008
MFC0200A/B	200mA	250V/125V		0.02
MFC0250A/B	250mA	250V/125V		0.026
MFC0300A/B	300mA	250V/125V		0.047
MFC0315A/B	315mA	250V/125V		0.055
MFC0350A/B	350mA	250V/125V		0.072
MFC0400A/B	400mA	250V/125V		0.10
MFC0500A/B	500mA	250V/125V		0.16
MFC0630A/B	630mA	250V/125V		0.28
MFC0750A/B	750mA	250V/125V	35A@250V AC (100mA~1A);	0.49
MFC0800A/B	800mA	250V/125V		0.60
MFC1100A/B	1A	250V/125V	100A@250V AC (1.25A~3.5A);	0.8
MFC1125A/B	1.25A	250V/125V		1.6
MFC1150A/B	1.5A	250V/125V	200A@250V AC (4A~10A).	2.5
MFC1160A/B	1.6A	250V/125V		3.2
MFC1200A/B	2A	250V/125V		5.6
MFC1250A/B	2.5A	250V/125V		7.6
MFC1300A/B	3A	250V/125V	14	
MFC1315A/B	3.15A	250V/125V	19	
MFC1350A/B	3.5A	250V/125V	20	
MFC1400A/B	4A	250V/125V	25	
MFC1500A/B	5A	250V/125V	42	
MFC1600A/B	6A	250V/125V	80	
MFC1630A/B	6.3A	250V/125V	96	
MFC1800A/B	8A	250V/125V	200	
MFC2100A/B	10A	250V/125V	320	
MFC2120A/B	12A	250V/125V	470	
MFC2150A/B	15A	250V/125V	650	
MFC2200A/B	20A	250V/125V	870	
MFC2250A/B	25A	250V/125V	1320	
MFC2300A/B	30A	250V/125V	1820	

Dimensions 尺寸

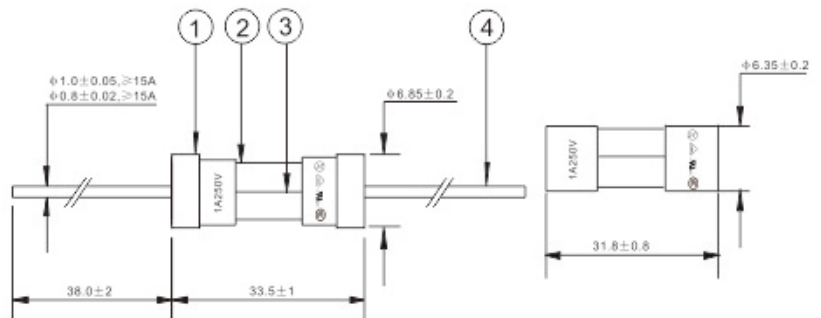

MTC Series 6*32mm Time-Lag Glass Tube Fuse



Agency Approvals 安規認證

Agency	Ampere Range	Agency File Number
	100mA ~ 30A	Pending
	100mA ~ 30A	E340427 (JDYX8)
	100mA ~ 30A	Pending
	100mA ~ 30A	Pending

Electrical Characteristics 電氣特性

% of Ampere Rating(In)	Blowing Time
100%* In	(4 hours Min)
135%* In	(1 hour Max)
200%* In	(120 sec Max)

Materials 材質

Part Name	Material
Cap	Nickel Plated Brass
Body	Glass Tube
Fuse element	Alloy
Lead wire	Tin Plated Copper

Packaging 包裝

Packing type	Description
Bulk	200PCS per bag
Box	4,000PCS per box

Catalog Number	Ampere Rating	Voltage Rating	Breaking Capacity	I ² T Melting Integral(A ² .S)
MTC0100A/B	100mA	250V/125V	10000A@125 V AC (100mA-10A);	0.028
MTC0160A/B	160mA	250V/125V		0.075
MTC0200A/B	200mA	250V/125V		0.12
MTC0250A/B	250mA	250V/125V		0.15
MTC0300A/B	300mA	250V/125V		0.19
MTC0315A/B	315mA	250V/125V		0.22
MTC0350A/B	350mA	250V/125V		0.29
MTC0400A/B	400mA	250V/125V		0.28
MTC0500A/B	500mA	250V/125V		0.52
MTC0630A/B	630mA	250V/125V		0.87
MTC0750A/B	750mA	250V/125V	35A@250V AC (100mA-1A);	1.1
MTC0800A/B	800mA	250V/125V		1.4
MTC1100A/B	1A	250V/125V	100A@250V AC (1.25A-3.5A);	3.5
MTC1125A/B	1.25A	250V/125V		7.6
MTC1150A/B	1.5A	250V/125V		9.1
MTC1160A/B	1.6A	250V/125V		13
MTC1200A/B	2A	250V/125V		20
MTC1250A/B	2.5A	250V/125V		39
MTC1300A/B	3A	250V/125V		61
MTC1315A/B	3.15A	250V/125V		56
MTC1350A/B	3.5A	250V/125V		70
MTC1400A/B	4A	250V/125V		104
MTC1500A/B	5A	250V/125V	148	
MTC1600A/B	6A	250V/125V	173	
MTC1630A/B	6.3A	250V/125V	192	
MTC1800A/B	8A	250V/125V	380	
MTC2100A/B	10A	250V/125V	580	
MTC2120A/B	12A	250V/125V	723	
MTC2150A/B	15A	250V/125V	934	
MTC2200A/B	20A	250V/125V	1280	
MTC2250A/B	25A	250V/125V	1678	
MTC2300A/B	30A	250V/125V	2036	

Dimensions 尺寸

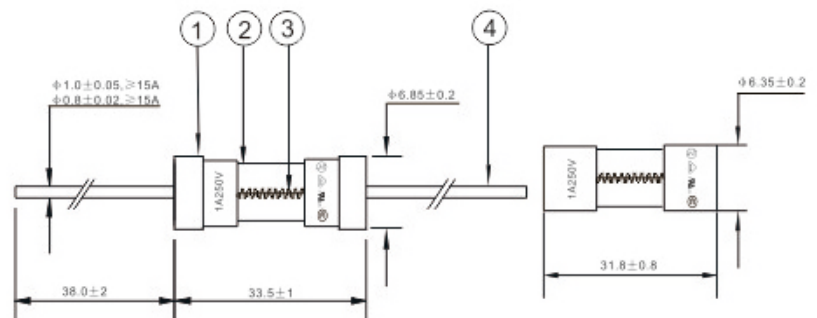

PFU/HFP Series 3.6*10mm Fast-Acting Ceramic Tube Fuse



Agency Approvals 安規認證

Agency	Ampere Range	Agency File Number
	250mA ~10A	E340427(JDYX)
	250mA ~10A	E340427(JDYX7)
	250mA ~ 5A	Pending
	250mA ~ 5A	Pending

Electrical Characteristics 電氣特性

% of Ampere Rating(In)	Blowing Time
100%* In	(4 hours Min)
200%* In	(60sec Max)

Materials 材質

Part Name	Material
Cap	Nickel Plated Brass
Body	Glass Tube
Fuse element	Alloy
Lead wire	Tin Plated Copper

Packaging 包裝

Packing type	Description
Bulk	500PCS per bag
Box	5,000PCS per box

Catalog Number	Ampere Rating	Voltage Rating	Breaking Capacity	I ² T Melting Integral(A ² .S)
PFU0100A/B	100mA	250V/125V	50A@125V/250VAC	0.0015
PFU0125A/B	125mA	250V/125V	50A@125V/250VAC	0.0025
PFU0160A/B	160mA	250V/125V	50A@125V/250VAC	0.0042
PFU0200A/B	200mA	250V/125V	50A@125V/250VAC	0.0065
PFU0250A/B	250mA	250V/125V	50A@125V/250VAC	0.010
PFU0300A/B	300mA	250V/125V	50A@125V/250VAC	0.018
PFU0315A/B	315mA	250V/125V	50A@125V/250VAC	0.020
PFU0350A/B	350mA	250V/125V	50A@125V/250VAC	0.025
PFU0400A/B	400mA	250V/125V	50A@125V/250VAC	0.035
PFU0500A/B	500mA	250V/125V	50A@125V/250VAC	0.060
PFU0630A/B	630mA	250V/125V	50A@125V/250VAC	0.150
PFU0750A/B	750mA	250V/125V	50A@125V/250VAC	0.350
PFU0800A/B	800mA	250V/125V	50A@125V/250VAC	0.5
PFU1100A/B	1A	250V/125V	50A@125V/250VAC	0.6
PFU1125A/B	1.25A	250V/125V	50A@125V/250VAC	1.2
PFU1150A/B	1.5A	250V/125V	50A@125V/250VAC	1.6
PFU1160A/B	1.6A	250V/125V	50A@125V/250VAC	1.8
PFU1200A/B	2A	250V/125V	50A@125V/250VAC	2.4
PFU1250A/B	2.5A	250V/125V	50A@125V/250VAC	3.2
PFU1300A/B	3A	250V/125V	50A@125V/250VAC	6.0
PFU1315A/B	3.15A	250V/125V	50A@125V/250VAC	7.0
PFU1350A/B	3.5A	250V/125V	50A@125V/250VAC	7.5
PFU1400A/B	4A	250V/125V	50A@125V/250VAC	8.0
PFU1500A/B	5A	250V/125V	50A@125V/250VAC	15
PFU1600A/B	6A	250V/125V	50A@125V/250VAC	24
PFU1630A/B	6.3A	250V/125V	50A@125V/250VAC	28
PFU1700A/B	7A	250V/125V	50A@125V/250VAC	36
PFU1800A/B	8A	250V/125V	50A@125V/250VAC	42
PFU2100A/B	10A	250V/125V	50A@125V/250VAC	50

Dimensions 尺寸

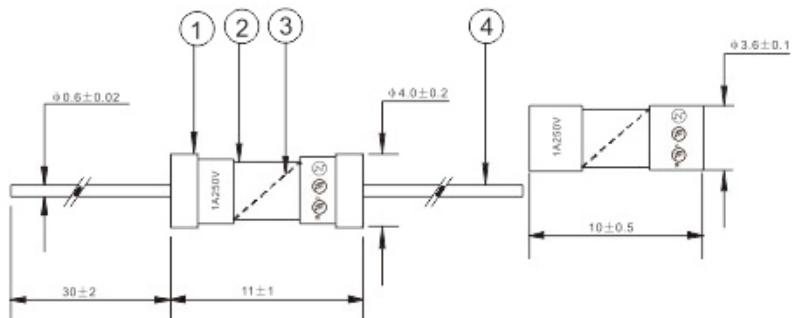

PTU/HTP Series 3.6*10mm Time-Lag Ceramic Tube Fuse



Agency Approvals 安規認證

Agency	Ampere Range	Agency File Number
	250mA ~ 10A	E340427(JDYX)
	250mA ~ 10A	E340427(JDYX7)
	250mA ~ 5A	Pending
	250mA ~ 5A	Pending

Electrical Characteristics 電氣特性

% of Ampere Rating(In)	Blowing Time
100%* In	(4 hours Min)
200%* In	(60 sec Max)

Materials 材質

Part Name	Material
Cap	Nickel Plated Brass
Body	Non-Transparent Ceramic Tube
Fuse element	Alloy
Lead wire	Tin Plated Copper

Packaging 包裝

Packing type	Description
Bulk	500PCS per bag
Box	5,000PCS per box

Catalog Number	Ampere Rating	Voltage Rating	Breaking Capacity	I ² T Melting Integral(A ² .S)
PTU0100A/B	100mA	250V/125V	50A@125V/250VAC	0.0042
PTU0125A/B	125mA	250V/125V	50A@125V/250VAC	0.010
PTU0160A/B	160mA	250V/125V	50A@125V/250VAC	0.025
PTU0200A/B	200mA	250V/125V	50A@125V/250VAC	0.035
PTU0250A/B	250mA	250V/125V	50A@125V/250VAC	0.056
PTU0300A/B	300mA	250V/125V	50A@125V/250VAC	0.10
PTU0315A/B	315mA	250V/125V	50A@125V/250VAC	0.12
PTU0350A/B	350mA	250V/125V	50A@125V/250VAC	0.15
PTU0400A/B	400mA	250V/125V	50A@125V/250VAC	0.25
PTU0500A/B	500mA	250V/125V	50A@125V/250VAC	0.35
PTU0630A/B	630mA	250V/125V	50A@125V/250VAC	0.55
PTU0750A/B	750mA	250V/125V	50A@125V/250VAC	0.70
PTU0800A/B	800mA	250V/125V	50A@125V/250VAC	1.1
PTU1100A/B	1A	250V/125V	50A@125V/250VAC	2
PTU1125A/B	1.25A	250V/125V	50A@125V/250VAC	3.8
PTU1150A/B	1.5A	250V/125V	50A@125V/250VAC	4.2
PTU1160A/B	1.6A	250V/125V	50A@125V/250VAC	6.2
PTU1200A/B	2A	250V/125V	50A@125V/250VAC	13
PTU1250A/B	2.5A	250V/125V	50A@125V/250VAC	18
PTU1300A/B	3A	250V/125V	50A@125V/250VAC	28
PTU1315A/B	3.15A	250V/125V	50A@125V/250VAC	32
PTU1350A/B	3.5A	250V/125V	50A@125V/250VAC	39
PTU1400A/B	4A	250V/125V	50A@125V/250VAC	43
PTU1500A/B	5A	250V/125V	50A@125V/250VAC	58
PTU1600A/B	6A	250V/125V	50A@125V/250VAC	70
PTU1630A/B	6.3A	250V/125V	50A@125V/250VAC	81
PTU1700A/B	7A	250V/125V	50A@125V/250VAC	92
PTU1800A/B	8A	250V/125V	50A@125V/250VAC	106
PTU2100A/B	10A	250V/125V	50A@125V/250VAC	120

Dimensions 尺寸

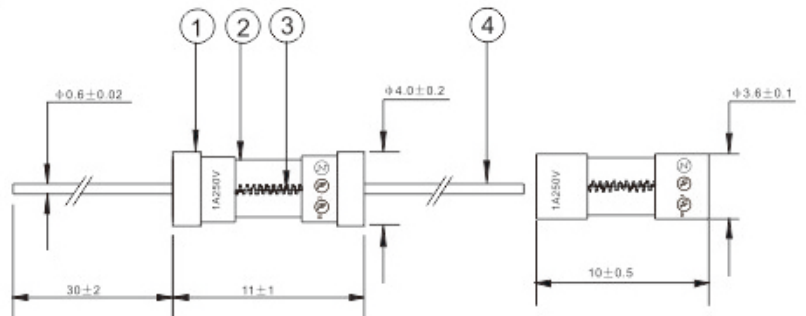

BFC Series 5*20mm Fast-Acting Ceramic Tube Fuse



Agency Approvals 安規認證

Agency	Ampere Range	Agency File Number
	200mA ~ 10A	E340427(JDYX2)
	200mA ~ 10A	E340427(JDYX8)
	200mA ~ 10A	2016010207899509
	200mA ~ 10A	Pending
	200mA ~ 10A	Pending
	200mA ~ 10A	PSE16021072

Electrical Characteristics 電氣特性

UL248-1/14 % of Ampere Rating(In)	Blowing Time
100%* In	(4 hours Min)
135%* In	(1 hour Max)
200%* In	(5 sec Max)

IEC 60127 % of Ampere Rating(In)	Blowing Time
210%* In	(30 min Max)
275%* In	(10 ms~2 s)

Materials 材質

Part Name	Material
Cap	Nickel Plated Brass
Body	Non-Transparent Ceramic Tube
Fuse element	Alloy
Lead wire	Tin Plated Copper

Packaging 包裝

Packing type	Description
Bulk	500PCS per bag
Box	5,000PCS per box

Catalog Number	Ampere Rating	Voltage Rating	Max Voltage Drop (mv)	I ² T Melting Integral(A ² .S)
BFC0100A/B	100mA	250V/125V	3500	0.0005
BFC0125A/B	125mA	250V/125V	2000	0.003
BFC0160A/B	160mA	250V/125V	2000	0.01
BFC0200A/B	200mA	250V/125V	1700	0.04
BFC0250A/B	250mA	250V/125V	1400	0.06
BFC0315A/B	315mA	250V/125V	1300	0.10
BFC0400A/B	400mA	250V/125V	1200	0.20
BFC0500A/B	500mA	250V/125V	1100	0.35
BFC0630A/B	630mA	250V/125V	650	0.50
BFC0800A/B	800mA	250V/125V	240	1.3
BFC1100A/B	1A	250V/125V	200	1.6
BFC1125A/B	1.25A	250V/125V	200	2.4
BFC1160A/B	1.6A	250V/125V	190	4.6
BFC1200A/B	2A	250V/125V	170	7.9
BFC1250A/B	2.5A	250V/125V	170	12
BFC1315A/B	3.15A	250V/125V	150	22
BFC1400A/B	4A	250V/125V	130	29
BFC1500A/B	5A	250V/125V	130	78
BFC1630A/B	6.3A	250V/125V	130	97
BFC1800A/B	8A	250V/125V	100	290
BFC2100A/B	10A	250V/125V	100	430
BFC2125A/B	12.5A	250V/125V	96	560
BFC2160A/B	16A	250V/125V	90	670
BFC2200A/B	20A	250V/125V	82	700
BFC2250A/B	25A	250V/125V	75	850
BFC2300A/B	30A	250V/125V	72	1000

Dimensions 尺寸

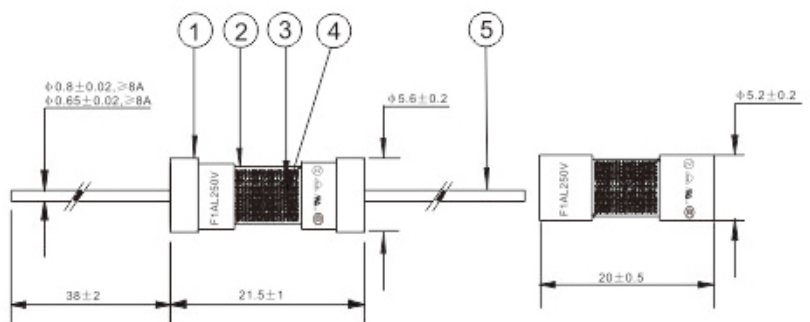

BTC Series 5*20mm Time-Lag Ceramic Tube Fuse



Agency Approvals 安規認證

Agency	Ampere Range	Agency File Number
	200mA ~ 10A	E340427(JDYX2)
	200mA ~ 10A	E340427(JDYX8)
	200mA ~ 10A	2016010207899506
	200mA ~ 10A	Pending
	200mA ~ 10A	Pending
	200mA ~ 10A	PSE16021071

Electrical Characteristics 電氣特性

UL248-1/14 % of Ampere Rating(In)	Blowing Time
100%* In	(4 hours Min)
135%* In	(1 hour Max)
200%* In	(5 sec Max)

IEC 60127 % of Ampere Rating(In)	Blowing Time
210%* In	(30 min Max)
275%* In	(750 ms~80 s)

Materials 材質

Part Name	Material
Cap	Nickel Plated Brass
Body	Non-Transparent Ceramic Tube
Fuse element	Alloy
Lead wire	Tin Plated Copper

Packaging 包裝

Packing type	Description
Bulk	500PCS per bag
Box	5,000PCS per box

Catalog Number	Ampere Rating	Voltage Rating	Max Voltage Drop (mv)	I ² T Melting Integral(A ² .S)
BTC0100A/B	100mA	250V/125V	7000	0.0005
BTC0125A/B	125mA	250V/125V	5000	0.0008
BTC0160A/B	160mA	250V/125V	4300	0.002
BTC0200A/B	200mA	250V/125V	3500	0.009
BTC0250A/B	250mA	250V/125V	2800	0.01
BTC0315A/B	315mA	250V/125V	2500	0.06
BTC0400A/B	400mA	250V/125V	2000	0.1
BTC0500A/B	500mA	250V/125V	1800	0.2
BTC0630A/B	630mA	250V/125V	1500	0.3
BTC0750A/B	750mA	250V/125V	1400	0.3
BTC0800A/B	800mA	250V/125V	1200	0.4
BTC1100A/B	1A	250V/125V	1000	0.6
BTC1125A/B	1.25A	250V/125V	800	0.8
BTC1150A/B	1.5A	250V/125V	600	1.0
BTC1160A/B	1.6A	250V/125V	600	1.2
BTC1200A/B	2A	250V/125V	500	3.4
BTC1250A/B	2.5A	250V/125V	400	7.2
BTC1300A/B	3A	250V/125V	350	8.5
BTC1315A/B	3.15A	250V/125V	350	9.2
BTC1350A/B	3.5A	250V/125V	350	9.2
BTC1400A/B	4A	250V/125V	300	14
BTC1500A/B	5A	250V/125V	250	25
BTC1600A/B	6A	250V/125V	250	25
BTC1630A/B	6.3A	250V/125V	200	64
BTC1700A/B	7A	250V/125V	200	81
BTC1800A/B	8A	250V/125V	200	96
BTC2100A/B	10A	250V/125V	200	106
BTC2120A/B	12A	250V/125V	180	125
BTC2125A/B	12.5A	250V/125V	180	135
BTC2150A/B	15A	250V/125V	160	160
BTC2160A/B	16A	250V/125V	160	170
BTC2200A/B	20A	250V/125V	150	200
BTC2250A/B	25A	250V/125V	120	240
BTC2300A/B	30A	250V/125V	100	300

Dimensions 尺寸

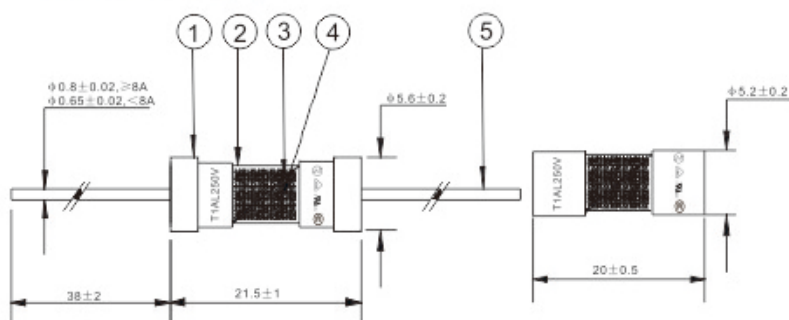

BMF Series 6.35*32mm Fast-Acting Ceramic Tube Fuse



Agency Approvals 安規認證

Agency	Ampere Range	Agency File Number
	100mA ~ 50A	E340427(JDYX2)
	100mA ~ 50A	E340427(JDYX8)

Electrical Characteristics 電氣特性

% of Ampere Rating(In)	Blowing Time
100%* In	(4 hours Min)
135%* In	(1 hour Max)
200%* In	(5 sec Max)

Materials 材質

Part Name	Material
Cap	Nickel Plated Brass
Body	Non-Transparent Ceramic Tube
Fuse element	Alloy
Lead wire	Tin Plated Copper

Packaging 包裝

Packing type	Description
Bulk	200PCS per bag
Box	4,000PCS per box

Catalog Number	Ampere Rating	Voltage Rating	Breaking Capacity
BMF0100A/B	100mA	250V/125V	35A@250V AC (100mA~1A);
BMF0160A/B	160mA	250V/125V	
BMF0200A/B	200mA	250V/125V	
BMF0250A/B	250mA	250V/125V	
BMF0300A/B	300mA	250V/125V	
BMF0315A/B	315mA	250V/125V	
BMF0350A/B	350mA	250V/125V	100A@250V AC (1.25A~3.5A);
BMF0400A/B	400mA	250V/125V	
BMF0500A/B	500mA	250V/125V	
BMF0630A/B	630mA	250V/125V	200A@250V AC (4A~10A).
BMF0750A/B	750mA	250V/125V	
BMF0800A/B	800mA	250V/125V	750A@250V AC (12A~30A).
BMF1100A/B	1A	250V/125V	
BMF1125A/B	1.25A	250V/125V	
BMF1150A/B	1.5A	250V/125V	1000A@250V AC (32A~50A)
BMF1160A/B	1.6A	250V/125V	
BMF1200A/B	2A	250V/125V	
BMF1250A/B	2.5A	250V/125V	
BMF1300A/B	3A	250V/125V	
BMF1315A/B	3.15A	250V/125V	
BMF1350A/B	3.5A	250V/125V	
BMF1400A/B	4A	250V/125V	
BMF1500A/B	5A	250V/125V	
BMF1600A/B	6A	250V/125V	
BMF1630A/B	6.3A	250V/125V	300V
BMF1800A/B	8A	250V/125V	500V
BMF2100A/B	10A	250V/125V	600V
BMF2120A/B	12A	250V/125V	750V
BMF2150A/B	15A	250V/125V	1000V
BMF2200A/B	20A	250V/125V	
BMF2250A/B	25A	250V/125V	
BMF2300A/B	30A	250V/125V	
BMF2400A/B	40A	250V/125V	
BMF2500A/B	50A	250V/125V	

Dimensions 尺寸

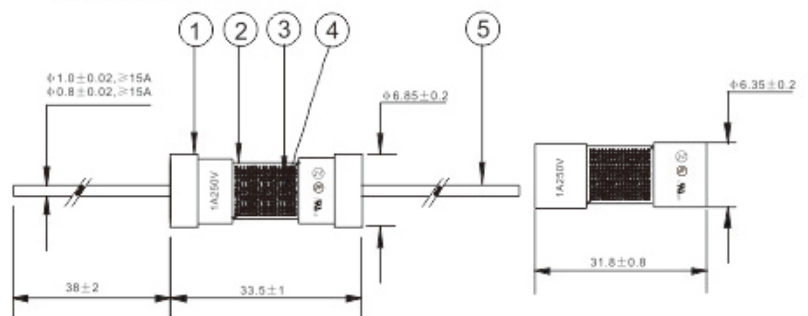

BMT Series 6.35*32mm Time-Lag Ceramic Tube Fuse



Agency Approvals 安規認證

Agency	Ampere Range	Agency File Number
	100mA ~ 50A	E340427(JDYX2)
	100mA ~ 50A	E340427(JDYX8)

Electrical Characteristics 電氣特性

% of Ampere Rating(In)	Blowing Time
100%* In	(4 hours Min)
135%* In	(1 hour Max)
200%* In	(120 sec Max)

Materials 材質

Part Name	Material
Cap	Nickel Plated Brass
Body	Non-Transparent Ceramic Tube
Fuse element	Alloy
Lead wire	Tin Plated Copper

Packaging 包裝

Packing type	Description
Bulk	200PCS per bag
Box	4,000PCS per box

Catalog Number	Ampere Rating	Voltage Rating	Breaking Capacity
BMT0100A/B	100mA	250V/125V	35A@250V AC (100mA~1A);
BMT0160A/B	160mA	250V/125V	
BMT0200A/B	200mA	250V/125V	
BMT0250A/B	250mA	250V/125V	
BMT0300A/B	300mA	250V/125V	
BMT0315A/B	315mA	250V/125V	
BMT0350A/B	350mA	250V/125V	
BMT0400A/B	400mA	250V/125V	
BMT0500A/B	500mA	250V/125V	
BMT0630A/B	630mA	250V/125V	
BMT0750A/B	750mA	250V/125V	100A@250V AC (1.25A~3.5A);
BMT0800A/B	800mA	250V/125V	
BMT1100A/B	1A	250V/125V	
BMT1125A/B	1.25A	250V/125V	200A@250V AC (4A~10A).
BMT1150A/B	1.5A	250V/125V	
BMT1160A/B	1.6A	250V/125V	750A@250V AC (12A~30A).
BMT1200A/B	2A	250V/125V	
BMT1250A/B	2.5A	250V/125V	
BMT1300A/B	3A	250V/125V	
BMT1315A/B	3.15A	250V/125V	
BMT1350A/B	3.5A	250V/125V	
BMT1400A/B	4A	250V/125V	
BMT1500A/B	5A	250V/125V	
BMT1600A/B	6A	250V/125V	
BMT1630A/B	6.3A	250V/125V	
BMT1800A/B	8A	250V/125V	
BMT2100A/B	10A	250V/125V	500V
BMT2120A/B	12A	250V/125V	
BMT2150A/B	15A	250V/125V	600V
BMT2200A/B	20A	250V/125V	
BMT2250A/B	25A	250V/125V	750V
BMT2300A/B	30A	250V/125V	
BMT2400A/B	40A	250V/125V	1000V
BMT2500A/B	50A	250V/125V	

Dimensions

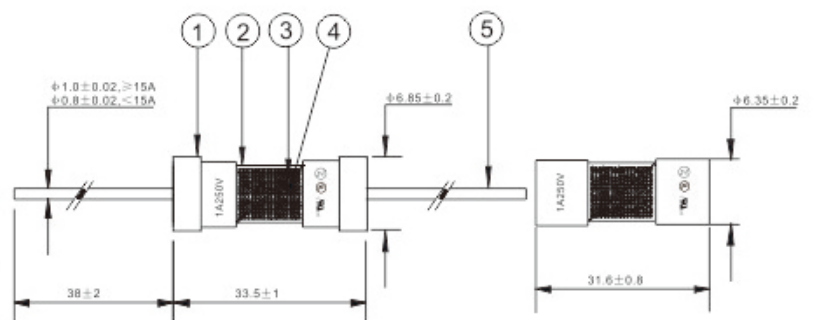

5.250/5.300/5.500/5.700 Series Fast-Acting Ceramic Tube Fuse
5.250/5.300/5.500/5.700 Series Time-Lag Ceramic Tube Fuse



• Agency Approvals 安規認證

Agency	Ampere Range	Agency File Number
	200mA~30A	E340427(JDYX2)
	200mA~30A	E340427(JDYX8)

• Electrical Characteristics 電氣特性

UL248-1/14 % of Ampere Rating(In)	Blowing Time
100%* In	(4 hours Min)
135%* In	(1 hour Max)
200%* In	(5 sec Max)

IEC 60127 % of Ampere Rating(In)	Blowing Time
210%* In	(30 min Max)
275%* In	(10 ms~2 s)

• Materials 材質

Part Name	Material
Cap	Nickel Plated Brass
Body	Non-Transparent Ceramic Tube
Fuse element	Alloy
Lead wire	Tin Plated Copper

• Packaging 包裝

Packing type	Description
Bulk	500PCS per bag
Box	5,000PCS per box

Catalog Number	Ampere Rating	Voltage Rating	Max Voltage Drop (mv)	I ² T Melting Integral(A ² .S)
5.250.***	100mA	250V	3500	0.0005
	125mA		2000	0.003
	160mA		2000	0.01
	200mA		1700	0.04
	250mA		1400	0.06
	315mA		1300	0.10
	400mA		1200	0.20
	500mA		1100	0.35
	630mA		650	0.50
	800mA		240	1.3
5.300.***	1A	300V	200	1.6
	1.25A		200	2.4
5.500.***	1.6A	500V	190	4.6
	2A		170	7.9
5.700.***	2.5A	700V	170	12
	3.15A		150	22
	4A		130	29
	5A		130	78
	6.3A		130	97
	8A		100	290
	10A		100	430
	12.5A		96	560
	16A		90	670
	20A		82	700
25A	75	850		
30A	72	1000		

• Dimensions 尺寸

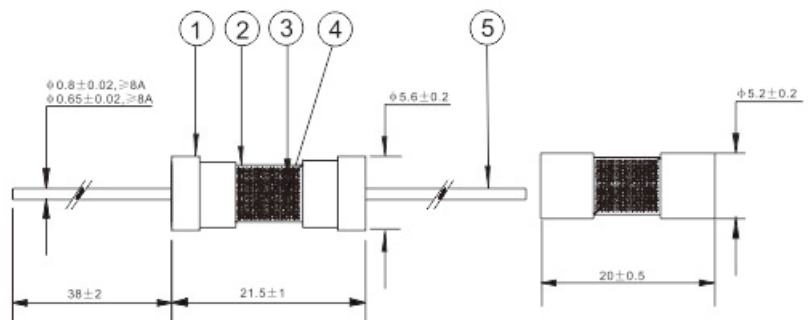

6.250/6.300/6.500/6.600/6.750/6.000 Series Fast-Acting Ceramic Tube Fuse
 6.250/6.300/6.500/6.600/6.750/6.000 Series Time-Lag Ceramic Tube Fuse



Catalog Number	Part No .	Rated Voltage	Rated Current	Breaking Capacity (A)
		AC/DC		DC
6.250.***	.0.2	250V	200mA	10KA
	.25		250mA	
	.0.4		400mA	
	.0.5		500mA	
	.0.6		600mA	
	.1		1A	
	.1.25		1.25A	
	.2		2A	
	.2.5		2.5A	
	.3		3A	
6.300.***	.3.15	300V	3.15A	10KA
	.4		4A	
6.500.***	.5	500V	5A	10KA
	.6		6A	
6.600.***	.8	600V	8A	10KA
	.10		10A	
6.750.***	.12	750V	12A	10KA
	.12.5		12.5A	
	.15		15A	
	.16		16A	
	.20		20A	
	.25		25A	
	.30		30A	
	.40		40A	
	.50		50A	
	6.000.***		.10	
.12.5		12.5A		
.15		15A		
.16		16A		
.20		20A		
.25		25A		
.30		30A		
.40		40A		
.50		50A		

- DC Cold Resistance are measured at <10% of rated current in ambient temperature of 25°C
- Typical Pre-arching I²t are measured at 10In Current
- For current rating other than above, please contact REOMAX

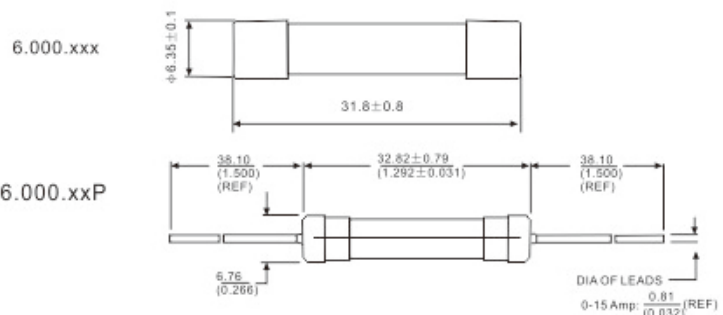

Description

- Fast Acting, high breaking capacity under 1000VDC
- 6.35x32mm physical size
- Special Engineering Material tube, Silver plated copper cap construction
- Designed to UL 248-1
- Lead Free and Halogen free material

Electrical Characteristics

1.0In	4 hour Min.
2.5In	120 sec Max.

Fast acting fuse 快速熔斷器

VOLTAGE RANGE:
AMPERE RANGE:
INTERRUPTING RATING:

EHV7 Series Square Body, aR

690V-1EC 700V-UL
40A-2000A
IR200kA
Both with / without
indicator version available



(Pending)



NHV5 Series North American, High Speed

500V AC/DC
35A-1600A
IR 200kA@500VAC
IR 50kA@500VDC



(Pending)



NHV7 Series North American, High Speed

700V AC/DC
5A-1200A
IR 200kA@700VAC
IR 50kA@700VDC



(Pending)



VOLTAGE RANGE:
AMPERE RANGE:
INTERRUPTING RATING:

BHV7.80 BS88, High Speed

690V AC/500V DC
6A-710A
IR200kA RMS Sym



(Pending)



BHV7.80 BS88, High Speed

690V AC/500V DC
6A-710A
IR200kA RMS Sym



(Pending)



HEV Series 10x38, High Speed for HEV

600V AC/700V DC & 1000V AC/DC
100mA-30A
IR 100kA@600V AC & IR 100kA @ 1000V AC
IR 50kA @ 700V DC & IR 50kA @ 1000V DC



**1000Vdc, 10x38mm, Photovoltaic Fuses
PV1000. Series**

PV Fuse Holder PVRH1U Series



Description

1000Vdc Fuse for Solar Panel Applications
 10x38mm physical size
 Designed to UL 2579
 Capable of interrupting low overcurrents associated with faulted
 Lead Free and Halogen free material

Description

Agency ratings up to 1000Vdc for use with solar PV fuses.
 Rated for use with 75°C or 90°C wire, fine stranded wire, spade terminals
 and comb-bus bars. Use any higher temperature rated wire with
 appropriate derating.
 Designed to UL 4248-18
 Lead Free and Halogen free material

Specifications

Part No .	Rated Voltage	Rated Current	Breaking Capacity
	DC		DC
PV1000.1A	1000V	1A	UL 10kA IEC 33kA Time Constant 1-3ms
PV1000.2A		2A	
PV1000.3A		3A	
PV1000.3.5A		3.5A	
PV1000.4A		4A	
PV1000.5A		5A	
PV1000.6A		6A	
PV1000.8A		8A	
PV1000.10A		10A	
PV1000.12A		12A	
PV1000.15A		15A	

Specifications

Voltage&Current:	600V/1000VDC, 30A
Terminal Rating:	Solid, Stranded, Fine Stranded, Spade Lug, Comb Bus Bar; Single and Dual Wire; 75°C and 90°C Cu wire
SCCR Rating:	UL 10kA/1000Vdc; IEC 33kA/1000Vdc
Fuse:	REOMAX FUSE Pv1000 Series
Wire Range:	#18 to #4 (0.8mm ² to 21.1mm ²)
Torque Ratings:	30 Lb-In (3.4 • m) maximum
Flammability Ratings:	UL 94V0, self-extinguishing
Storage & Operating Temperature Range:	-20°C to +120°C

- DC Cold Resistance are measured at <10% of rated current in ambient temperature of 25°C
- Typical Pre-arching I²t are measured at 10In Current
- Min Interrupting Rating: 1.35 x In
- Fuse Coordination w/: Thin film cells and 4 " , 5 " and 6 " crystalline silicon cells.

SMD 4532/ 1812Ceramic Gas Discharge Tube

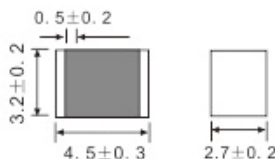
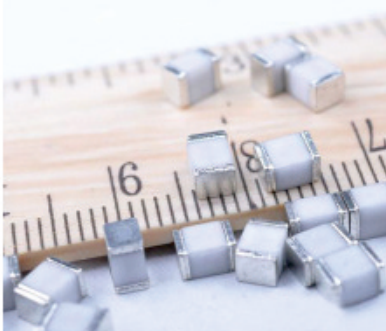

- Resettable overvoltage protection
- ROHS compliant
- Small size:4.5x3.2x2.7mm.
- Wide range of voltages (90V-600V)
- Low capacitance and insertion loss
- Crowbar device with low arc voltage, no polarity
- High accuracy spark-over voltages for high precision designs

Part Number 4532	DC Breakdown Voltage (V @100V/s)	Tolerance of DCBV	Impulse Breakdown Voltage[V @1KV/s)	AC Discharge Current (A @ 50Hz)	Surge Discharge Current (A @ 10/1000 μs)	Surge Discharge Current (KA @ 8/20 μs)	Insulation Resistance (M Ω)	Electrode Capacitance (pF @ 1MHz)
RMV-RM090M-CA3	90	±20%	≤700	2	50	2	≥1000	≤1
RMV-RM150M-CA3	150	±20%	≤700	2	50	2	≥1000	≤1
RMV-RM230M-CA3	230	±20%	≤700	2	50	2	≥1000	≤1
RMV-RM350M-CA3	350	±20%	≤900	2	50	2	≥1000	≤1
RMV-RM470M-CA3	470	±20%	≤1000	2	50	2	≥1000	≤1
RMV-RM600M-CA3	600	±20%	≤1200	2	50	2	≥1000	≤1

绕线.金属膜.氧化膜.碳膜.电阻器系列 FIXED RESISTOR

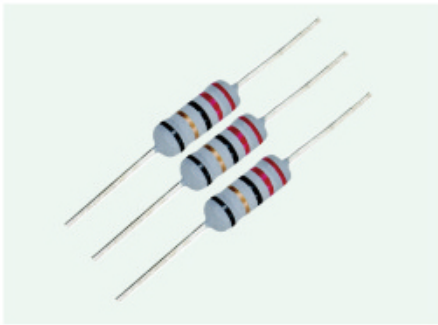

绕线电阻(有感&无感)
RESISTOR(INDUCTIVE TYPE&NON-INDUCTIVE TYPE)
(KNP/NKNP)

Feature

The fabric of wirewound Resistor is to wind the resistance wire on a ceramic core.

- Low noise
- Resistance tolerance: $\pm 2\%$, $\pm 5\%$
- There are 5 color bands on surface.KNP and NKNP are distinguished by 5th color band.

Power Rating		Dimension(mm)					KNP Resistance Range(Ω)	NKNP Resistance Range(Ω)	Dielectric withstanding Voltage
STD type	Mini type	ϕ D	L	H	ϕ d \pm 0.05				
1/2W	1WS	3.5 \pm 0.5	9.0 \pm 0.5	26 \pm 2	0.50	0.05 Ω -30 Ω	0.05 Ω -6 Ω	300V	
1W	2WS	4.5 \pm 0.5	11.5 \pm 1.0	35 \pm 3	0.70	0.05 Ω -40 Ω	0.05 Ω -8 Ω	350V	
2W	3WS	5.0 \pm 0.5	15.5 \pm 1.0	33 \pm 3	0.70	0.05 Ω -50 Ω	0.05 Ω -10 Ω	350V	
3W	5WS	6.0 \pm 0.5	17.5 \pm 1.0	38 \pm 3	0.70	0.05 Ω -250 Ω	0.1 Ω -50 Ω	400V	
5W		8.0 \pm 0.5	24.5 \pm 1.0	35 \pm 3	0.70	0.05 Ω -250 Ω	0.1R-50R	400V	

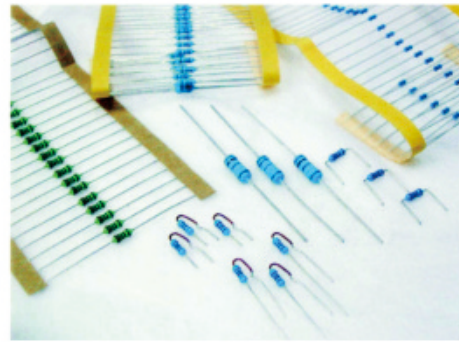

金属皮膜固定电阻器(精密电阻)
FIXED RESISTOR(MF)

Feature

- High quality
- Standard tolerance: $\pm 0.5\%$, $\pm 1\%$, $\pm 2\%$, $\pm 5\%$
- Temperature coefficient: ± 25 PPM ± 50 PPM, ± 100 PPM

Power Rating		Dimension(mm)					Resistance Range(Ω)	Max Working Voltage(RCVV)	Max Overload Voltage	Dielectric withstanding Voltage
		ϕ D	L	H	ϕ d \pm 0.05					
1/6W, 1/8W		1.8 \pm 0.5	3.2 \pm 0.5	28 \pm 2	0.40	1 Ω -10M Ω	150V	300V	300V	
1/4W		2.3 \pm 0.5	6.5 \pm 0.5	28 \pm 2	0.45	1 Ω -10M Ω	250V	500V	350V	
1/2WS		2.3 \pm 0.5	6.5 \pm 0.5	28 \pm 2	0.45	1 Ω -10M Ω	250V	500V	350V	
1/2W		3.2 \pm 0.5	9.0 \pm 0.5	26 \pm 2	0.50	1 Ω -10M Ω	350V	700V	400V	
1WS		3.2 \pm 0.5	9.0 \pm 0.5	26 \pm 2	0.50	1 Ω -10M Ω	350V	700V	400V	
1W		4.5 \pm 1.0	11.5 \pm 1.0	35 \pm 3	0.70	1 Ω -10M Ω	350V	800V	450V	
2WS		4.5 \pm 1.0	11.5 \pm 1.0	35 \pm 3	0.70	1 Ω -10M Ω	350V	800V	450V	
2W		5.0 \pm 1.0	15.5 \pm 1.0	33 \pm 3	0.70	1 Ω -10M Ω	500V	800V	500V	
3WS		5.0 \pm 1.0	15.5 \pm 1.0	33 \pm 3	0.70	1 Ω -10M Ω	500V	1000V	500V	

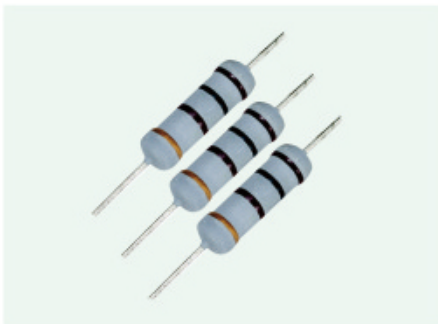

不燃性金属氧化皮膜固定电阻器
FIXED RESISTOR(MOF)

Feature

- Low cost, prompt delivery
- Long term stability
- Wide resistance range:0.1 Ω to 100K Ω
- Resistance tolerance: $\pm 1\%$, $\pm 2\%$, $\pm 5\%$

Power Rating		Dimension(mm)					Resistance Range(Ω)	Max Working Voltage(RCVV)	Max Overload Voltage	Dielectric withstanding Voltage
		ϕ D	L	H	ϕ d \pm 0.05					
1/4W		2.3 \pm 0.5	6.5 \pm 0.5	28 \pm 2	0.45	0.1-100K	250V	400V	250V	
1/2WS		2.3 \pm 0.5	6.5 \pm 0.5	28 \pm 2	0.45	0.1-100K	250V	400V	250V	
1/2W		3.2 \pm 0.5	9.0 \pm 0.5	26 \pm 2	0.50	0.1-100K	250V	400V	350V	
1WS		3.2 \pm 0.5	9.0 \pm 0.5	26 \pm 2	0.50	0.1-100K	350V	600V	350V	
1W		4.5 \pm 1.0	11.5 \pm 1.0	35 \pm 3	0.70	0.1-100K	350V	600V	400V	
2WS		4.5 \pm 1.0	11.5 \pm 1.0	35 \pm 3	0.70	0.1-100K	350V	600V	400V	
2W		5.0 \pm 1.0	15.5 \pm 1.0	33 \pm 3	0.70	0.1-100K	350V	800V	400V	
3WS		5.0 \pm 1.0	15.5 \pm 1.0	33 \pm 3	0.70	0.1-100K	350V	800V	400V	
3W		6.0 \pm 1.0	17.5 \pm 1.0	38 \pm 3	0.70	0.1-100K	500V	800V	400V	
5WS		6.0 \pm 1.0	17.5 \pm 1.0	38 \pm 3	0.70	0.1-100K	500V	800V	400V	
5W		8.0 \pm 1.0	24.5 \pm 1.0	35 \pm 3	0.70	0.1-100K	750V	1000V	400V	

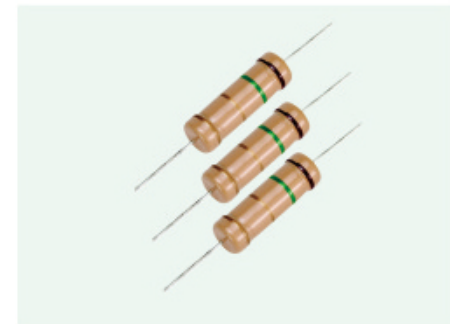

碳素皮膜固定电阻器
FIXED RESISTOR(CF)

Feature

- Low cost, prompt delivery
- Long term stability
- Wide resistance range:0.1 Ω to 10M Ω
- Resistance tolerance: $\pm 2\%$, $\pm 5\%$, $\pm 10\%$

Power Rating		Dimension(mm)					Resistance Range(Ω)	Max Working Voltage(RCVV)	Max Overload Voltage	Dielectric withstanding Voltage
		ϕ D	L	H	ϕ d \pm 0.05					
1/6W, 1/8W		1.8 \pm 0.5	3.2 \pm 0.5	28 \pm 2	0.40	1 Ω -10M Ω	200V	400V	300V	
1/4W		2.3 \pm 0.5	6.5 \pm 0.5	28 \pm 2	0.45	1 Ω -10M Ω	250V	500V	350V	
1/2WS		2.3 \pm 0.5	6.5 \pm 0.5	28 \pm 2	0.45	1 Ω -10M Ω	250V	500V	350V	
1/2W		3.2 \pm 0.5	9.0 \pm 0.5	26 \pm 2	0.50	1 Ω -10M Ω	350V	700V	400V	
1WS		3.2 \pm 0.5	9.0 \pm 0.5	26 \pm 2	0.50	1 Ω -10M Ω	350V	700V	400V	
1W		4.5 \pm 1.0	11.5 \pm 1.0	35 \pm 3	0.70	1 Ω -10M Ω	500V	800V	450V	
2WS		4.5 \pm 1.0	11.5 \pm 1.0	35 \pm 3	0.70	1 Ω -10M Ω	500V	800V	450V	
2W		5.0 \pm 1.0	15.5 \pm 1.0	33 \pm 3	0.70	1 Ω -10M Ω	500V	1000V	450V	
3WS		5.0 \pm 1.0	15.5 \pm 1.0	33 \pm 3	0.70	1 Ω -10M Ω	500V	1000V	450V	
3W		6.0 \pm 1.0	17.5 \pm 1.0	38 \pm 3	0.70	1 Ω -10M Ω	500V	1000V	500V	

AFB系列 耐冲击型 超小型 快断 保险丝 AFB Series Impact resistance type Fast-Acting Micro Fuse

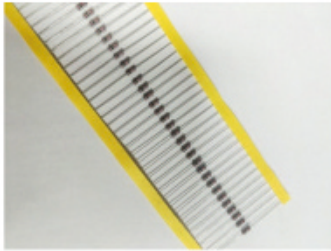

% of Ampere Rating(In)	Blowing Time
150% *In	大于1小时(4 hours Min)
210% *In	小于60秒(60 sec Max)

Catalog No.	Ampere Rating	Voltage Rating	Breaking Capacity
AFB1 100A/B	1A	250V/125V	35A@125V/250VAC
AFB1200A/B	2A	250V/125V	35A@125V/250VAC
AFB1300A/B	3A	250V/125V	35A@125V/250VAC

•Packing 包装

Packing type	Description
Bulk	500PCS per bag
Box	5,000PCS per box

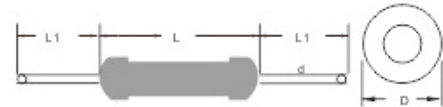

规格	公差	L±0.5	D±0.2	L±1	d±0.2
1A-----3A		6.5	2.3	26	0.45

RXM 贴片保险电阻

结构图 Construction

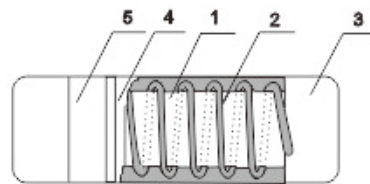

- 1. 瓷芯 Ceramic core
- 2. 电阻丝 Resistive wire
- 3. 镀锡铁帽 Tinned iron cap
- 4. 标志颜色代码 Marking/Color code
- 5. 绝缘涂料 Insulation coating

封装颜色 Coating color: 灰色 Gray

规格命名 Type Designation

例 Example

品种 Product code	尺寸 Dimensions	额定功率 Power Rating	阻值精度 Resistance Tolerance	阻值精度 Resistance Tolerance	包装方式 Package
RXM	0309	1WS	10R	J	T
0207 0309	25:0.25W 50:0.5W 50S:0.5WS 1WS:1WS 25S:25WS	Example R10:0.1Ω 10R:10Ω	G:±2% J:±5%	T:Tapping Reel B:Bulk	

外形尺寸 Dimensions

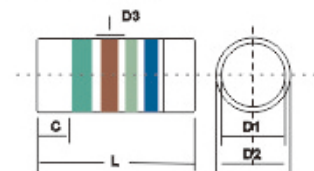

型号 Type	尺寸 Dimension(mm)				
	L	D1	D2Max	D3Max	C/min
RXM0207	5.9±0.2	2.2±0.2	2.4	0.15	0.8
RXM0309	8.5±0.2	3.0±0.3	2.4	0.3	1.5

特性 Features

表面贴装结构
电及强度坚固
耐热性好、温度系数小、噪声低、负荷功率大
长期称定性优良

SMD structure
The electrode strength is firm
Good heat-durability, low temperature coefficient, low noise, high overload power.
Stable long life

PTC fuse 自恢復保險絲

SMD type 貼片系列

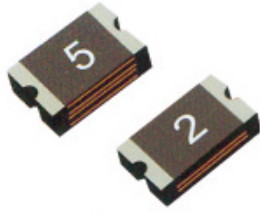

FSMD0603

Operation current:0.01A-1A
V max:6~16Vdc,I max:40A
PC motherboards,Mobile phones

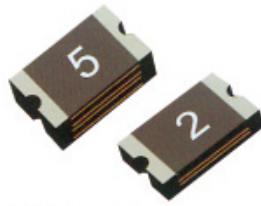

PSMD0805

Operation current:0.05A~1.5A
V max:6~24Vdc,I max:40A
USB,Mobile phones,PC motherboards

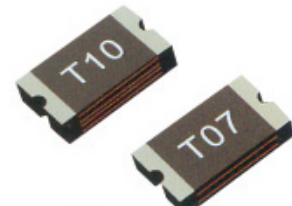

NSMD1206

Operation current:0.05A~3.5A
V max:6~48Vdc,I max:10A~100A
USB Port Protection,Mobile Phones

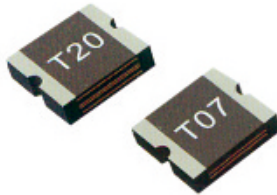

USMD1210

Operation current:0.05A~2.60A
V max:6~30Vdc,I max:10A~40A
USB Port protection,Mobile phones

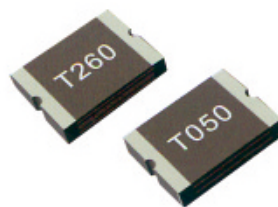

MSMD1812

Operation current:0.10A~4.00A
V max:6~60Vdc,I max:20A~100A
PC motherboards,POS equipment
USB Port protection

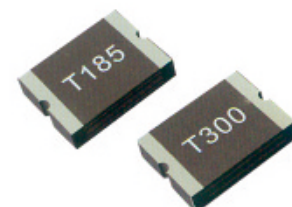

LSMD2920

Operation current:0.30A~7.00A
V max:6~60Vdc,I max:100A~40A
Toys,USB,Power,etc.
Electrical equipment

LOW Ro strap and SMD type (低損耗電池片與貼片系列)

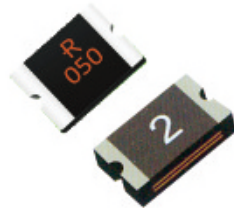

Low Ro FSML0603

Operation current:0.05A~1.00A
V max:6Vdc,I max:50A
Battery pack protection
(On Development)

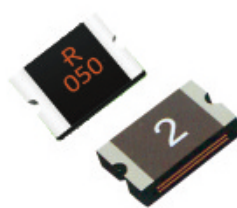

Low Ro PSML0805

Operation current:0.75A~2.00A
V max:6Vdc,I max:50A
Battery pack protection
(On Development)



Low Ro NSML1206

Operation current:0.50A~3.50A
V max:6Vdc,I max:50A
Battery pack protection
(NSML 175,NSML190,NSML200)

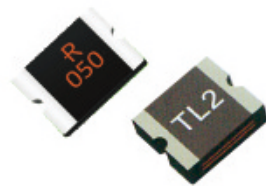

Low Ro USML1210

Operation current:1.75A~4.50A
V max:6Vdc,I max:50A
Battery pack protection(USML190,
USML200,USML260,USML300)

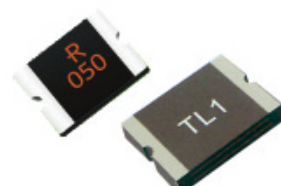

Low Ro USML1812

Operation current:1.40A~4.50A
V max:6Vdc,I max:50A
Battery pack
(USML180,USML190,MSML260)

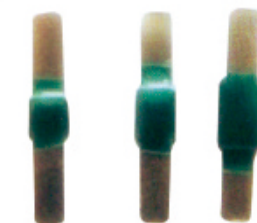

TAL

Operation current:1.10A~4.50A
V max:6Vdc,I max:50A
Rechargeable battery pack protection

PTC fuse自恢復保險絲

LEADED type 插脚系列

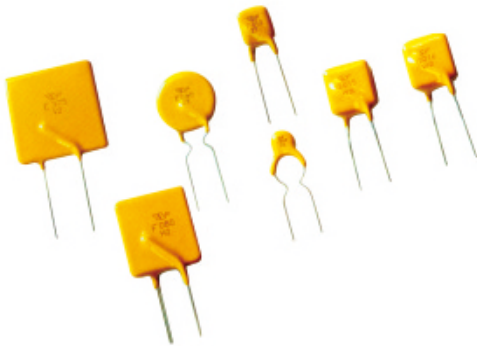

TRF(250Vdc)

Operation Current:0.02A~2.00A
Operation Vmax:60Vdc
Max interrupt Vmax:250Vdc
Telecom field

TRA(16Vdc)

Operation Current:0.05A~14.00A
VMAX:16VDC,IMAX:40A.
Wide Variety of Electronic Equipment

TRC(60/72Vdc)

Operation Current:0.05A~5.00A
VMAX:60/72VDC,IMAX:40A.
Wide Variety of Electronic Equipment

TRG(600Vdc)

Operation Current:0.15A~0.16A
Operation Vmax:60Vdc
Max interrupt Vmax:600Vdc
POS Equipment

TRB(30Vdc)

Operation Current:0.90A~9.00A
VMAX:30VDC,IMAX:40A.
Wide Variety of Electronic Equipment

TRE(90/120Vdc)

Operation Current:0.15A~5.00A
VMAX:90/120VDC,IMAX:10A.
Set-top boxest

TRM(120Vac/240Vac)

Operation Current:0.05A~0.55A
Operation Vmax:240Vac
Max interrupt Vmax:265Vac
Line Voltage Application



STRAP series 普通電池片系列

TLS

Operation current:0.70A~4.20A
Vmax:10~30Vdc,Imax:100A
Rechargeable battery
pack protection

TLV

Operation current:1.75A~7.30A
Vmax:10~30Vdc,Imax:100A
Rechargeable battery pack
protection

TVS

Operation current:1.70A~2.30A
Vmax:10~30Vdc,Imax:100A
Rechargeable battery pack
protection

电力型铝壳绕线电阻器

LARGE CAPACITY METAL-CLAD WIRE WOUND RESISOR

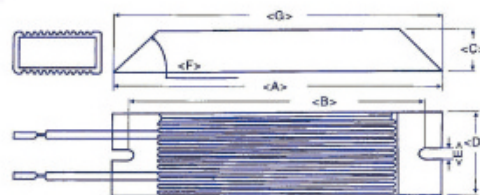

规格型号: SPECIFICATIONS

定格电力(W) Power Rating	尺寸 Dimensions(mm)							形式 Type	电阻值范围 (Ω) Resistance Range
	A±2	B±2	C±1	D±1	E±1	F±1	G±2		
AL-60W	115	100	20	40	5.2	45°	75	A type	0.1~10K
AL-80W	140	125	20	40	5.2	45°	100	A type	0.1~10K
AL-100W	165	150	20	40	5.2	45°	125	A type	0.1~10K
AL-120W	190	175	20	40	5.2	45°	150	A type	0.15~15K
AL-150W	215	200	20	40	5.2	45°	175	A type	0.15~15K
AL-200W	165	150	30	60	5.2	60°	125	A type	0.3~20K
AL-300W	215	200	30	60	5.2	60°	175	A type	0.5~30K
AL-400W	265	250	30	60	5.2	60°	225	A type	0.5~30K
AL-500W	240	225	40	80	5.2	60°	200	A type	0.5~30K
AL-600W	335	320	30	60	5.2	60°	295	A type	1~50K
AL-800W	400	385	40	80	5.2	60°	360	B type	1~50K
AL-1000W	400	385	50	100	30	5.2	380	B type	1~100K

熔断断体.温度保险丝 Temperature fuse

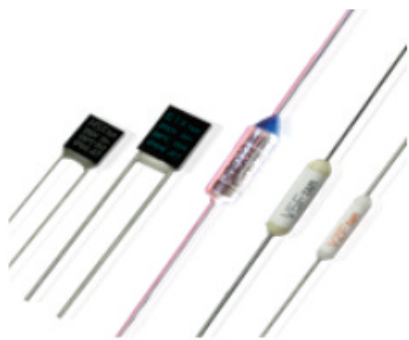

Temperature Characteristics Table

Voltage/ Current :
250V10A,250V15A
250V 1A 2A 3A 5A

温控范围 Operating
Temperature/scope
57-240°C

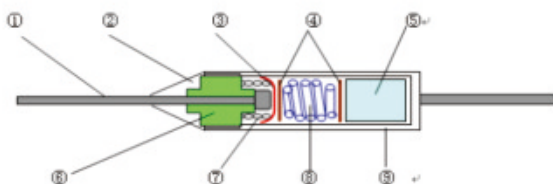

- 1) 引线 (Lead wire)
- 2) 封口树脂 (Epoxy)
- 3) 星状簧片 (Star contact)
- 4) 圆片 (Discs)
- 5) 感温体 (Thermal pellet)
- 6) 陶瓷绝缘子 (Ceramic bushing)
- 7) 弹簧A (Spring A)
- 8) 弹簧B (Spring B)
- 9) 金属外壳 (Metal case)

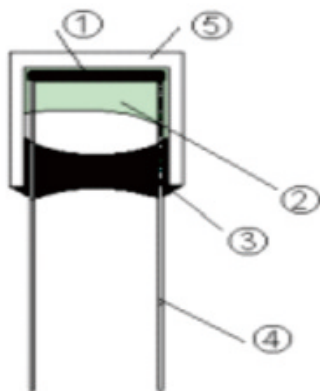

- (1) 易熔合金 Thermal alloy
- (2) 特殊树脂 Special resin compound
- (3) 环氧树脂 Epoxy
- (4) 镀锡铜线 Lead wire
- (5) 塑料外壳 Case

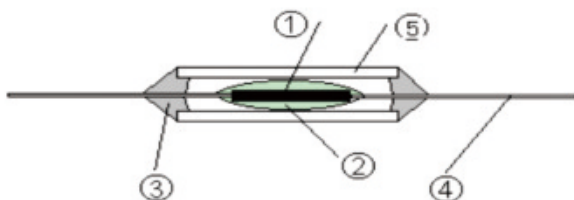

- (1) 易熔合金 Thermal alloy
- (2) 特殊树脂 Special resin compound
- (3) 环氧树脂 Epoxy
- (4) 镀锡铜线 Lead wire
- (5) 塑料外壳 Case

9700热保护器 9700 thermal protector

温度开关.过流 5A--10 A
Temperature switch. Flow 5 A -- 10 A

突跳式温控器 Thermostat

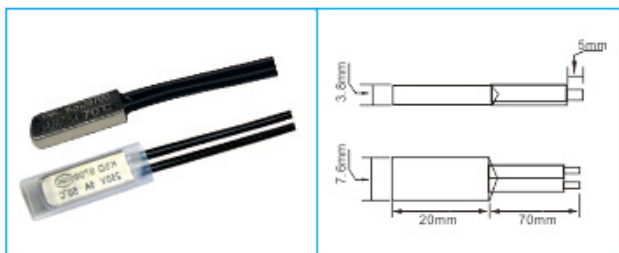

型号: R-CY-9700铁壳
尺寸: 4x7.8x20
使用于: 电机, 家用电器, 电动工具, 过胶机等

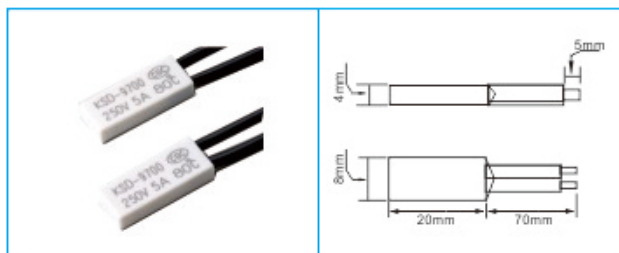

型号: R-CY-9700朔壳
尺寸: 4.0x8.0x20/4.0x7.3x15.5
使用于: 电机, 家用电器, 电动工具, 过胶机等

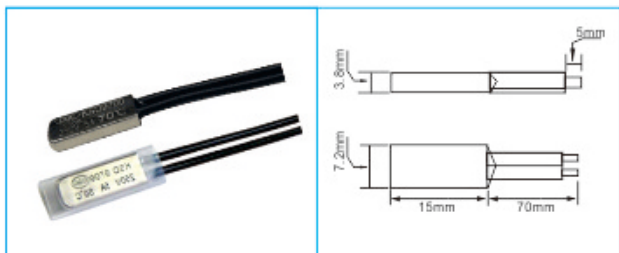

型号: R-CY-9700铁壳
尺寸: 3.8x7.2x15
使用于: 电机, 家用电器, 电动工具, 过胶机等

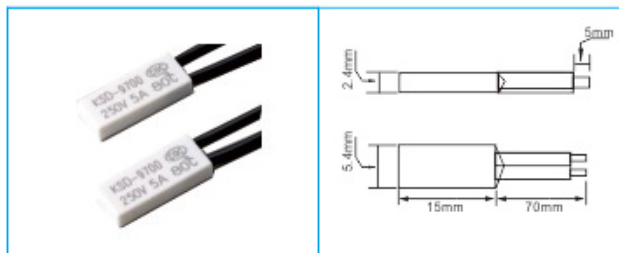

型号: R-CY-9700朔壳
尺寸: 2.4x5.4x15
使用于: 电机, 家用电器, 电动工具, 过胶机等

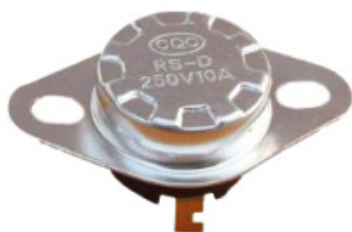

型号: RS-D/KSD-301

耐压值	2500V
过载电流	10A
动作温度	5-250℃
介质材料	电木或陶瓷

产品用途

主要用于马达电机饮水机、电热水瓶、消毒柜、咖啡壶、电熨斗、干衣机、空调器、热水器、电子瓦煲、消毒碗柜和电机吸尘器等电器。

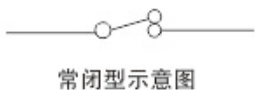

常闭型:
温控开关原始状态触点是闭合的, 当感温超过额定温度时触点断开。

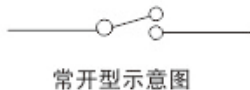

常开型:
温控开关原始状态触点是断开的, 当感温超过额定温度时触点闭合。

Fast acting fuse 快速熔斷器

熔斷器底座及配件

熔斷器座

模塊式

REOMAX[®]提供的多種熔斷器座，能使用戶的設計、生產更加靈活。兩塊相同的底座組合在一起，形成模塊式熔斷器底座。這種拼合式器件可以安裝在面板上，間隔不限，因此，適于安裝各種長度的熔斷器。

螺杆式

RHV系列模塊式熔斷器座設計簡潔，熔斷器端子及纜纜（帶接頭）可以安裝在同一個螺杆上，操作簡便。有關這種熔斷器座的配置，參閱下表

產品代碼	熔斷器最大額定電流	螺杆高度	螺杆直徑及螺紋
RHV-1	200A	1.00 #	5/16 -18
RHV-2	200A	1.75 #	5/16 -18
RHV-3	200A	0.75 #	5/16 -18
RHV-4	100A	1.00 #	1/4 -20
RHV-5	100A	1.75 #	1/4 -20

接頭式

REOMAX[®]還提供一種使用鍍錫接頭（適于導線端接，并有散熱作用）及鍍鋼螺栓（安裝熔斷器）的模塊式熔斷器座。有關接頭式熔斷器座的配置，參閱下表。如需了解詳細資料，請與本公司聯系。

模塊底座類型	最大電壓	熔斷器最大額定電流
BSHV101	600V	100A
BSHV102	600V	400A
BSHV103	600V	400A
BSHV104	600V	600A
RH-0xxx	700V	100A
RH-1xxx	2500V	400A
RH-2xxx	5000V	400A
RH-3xxx	1250V	700A

間距固定式

REOMAX[®]提供了固定式整流器熔斷器座。纜纜及熔斷器的連接與螺柱式熔斷器座相同，用雙頭螺栓安裝即可。如需了解詳細資料，請與本公司聯系。

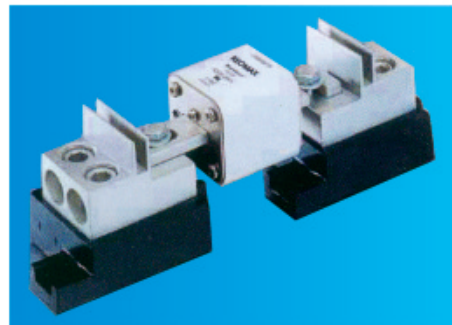
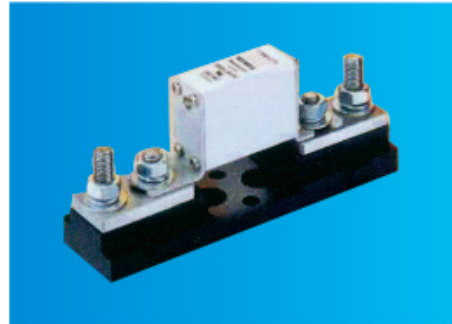
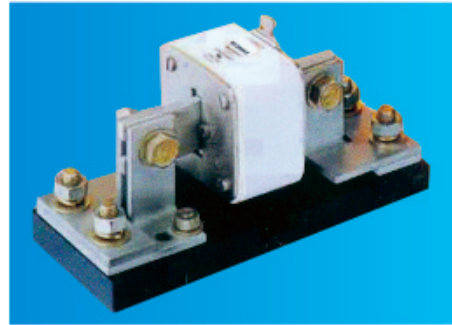

綫路板/面板安裝保險絲座 PCB/Panel mounting fuseholders



R3-12B

1. 10A 250V AC
2. ϕ 5.2x20mm
3. Screw type cap
4. Soldering terminal
5. Phenolic resin

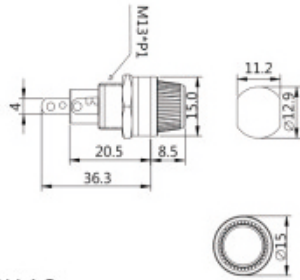

R3-13

Material:
Frame and cap: phenolic (UL flame: 94V-1)
Terminal: nickel plated brass.
Mounted by nut

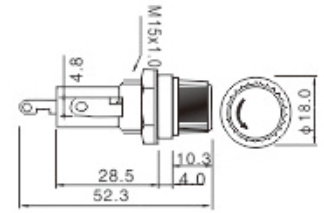

R3-22

Material:
Frame and cap: phenolic (UL flame: 94V-1)
Terminal: nickel plated brass.
Mounted by nut

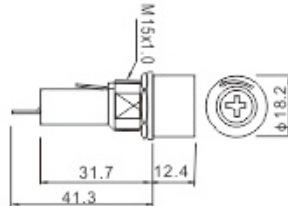

R3-24

Material:
Frame and cap: phenolic (UL flame: 94V-1)
Terminal: nickel plated brass.
PC terminal mounted.

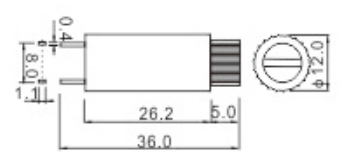

PTF-35

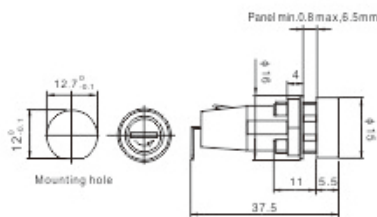

PTF-50

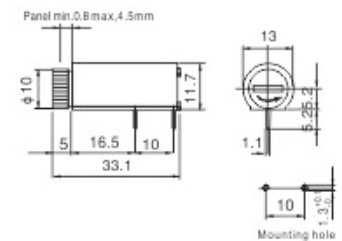

R3-8A

PCB Mount Fuse clips for 10x38mm
Mounting: PC Board 1.5mm pin spacing
Materials: Spring Brass
Rated Voltage: 250V-1000V
Max Current: 30A

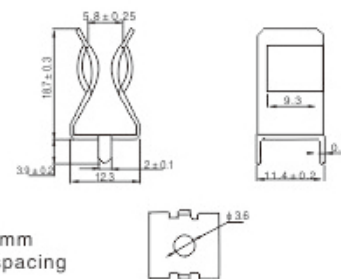

SL506J

PCB Mount Fuse clips for ATO Blade fuse
Specification:
Electrical: Max. 30A 500Vac
Material: Brass or Phosphor Bronze
Finish: Tin-plated or Nickel-plated
Contact Resistance: Max. 50m Ω

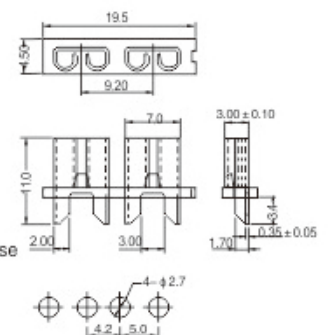

綫路板/面板安裝保險絲座 PCB/Panel mounting fuseholders



R3-5A

- 1. 10A 250V
- 2. $\Phi 5.2 \times 20\text{mm}$
- 3. Soldering terminal

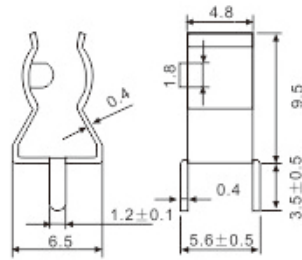

- 4. Brass, Ni-plated
- 5. RoHS, HF



R3-6A

- 1. 15A 250V
- 2. $\Phi 6.35 \times 32\text{mm}$
- 3. Soldering terminal

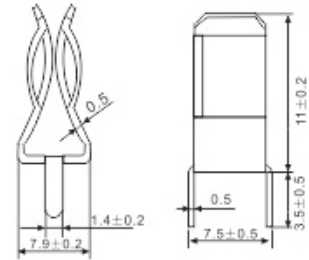

- 4. Brass, Ni-plated
- 5. RoHS, HF



PTF-78

- 1. 6.3A 250V AC
- 2. $\Phi 5.2 \times 20\text{mm}$
- 3. PC Board mount terminal
- 4. PA66
- 5. ul cqc ce vde

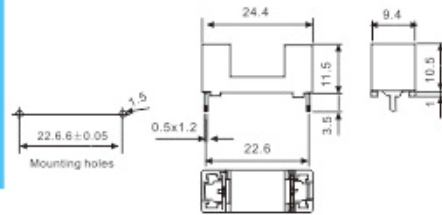

PTF-15

- 1. 10A 250V
- 2. $\Phi 5.2 \times 20\text{mm}$
- 3. PC Board mount terminal
- 4. P.B.T
- 5. ul cqc ce vde

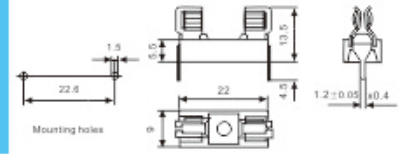

PTF-45

- 1. 10A 125V AC
- 2. 6.3A 250V AC
- 3. Bayonet type cap
- 4. PC Board mount terminal
- 5. P.B.T
- 6. ul cqc ce vde

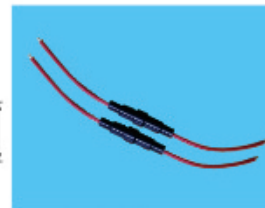
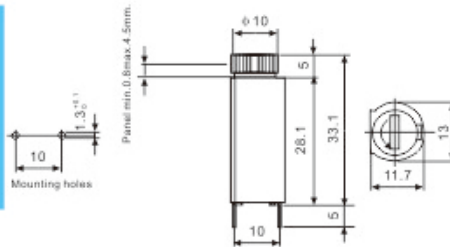

R5-20

- 1. 10A 125V AC
- 2. $\Phi 5.2 \times 20\text{mm}$
- 3. R5-01A/B, PA66 94-V0
- 4. PVC cable, UL1015, AWG22
- 5. ul cqc ce vde

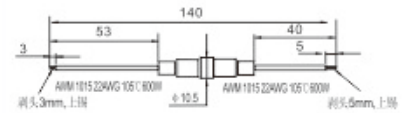

R3-11

- 1. 10A 250V AC
- 2. $\Phi 5.2 \times 20\text{mm}$
- 3. A: Bayonet type cap C: Screw type cap
- 4. Soldering terminal
- 5. Phenolic resin
- 6. ul cqc ce vde

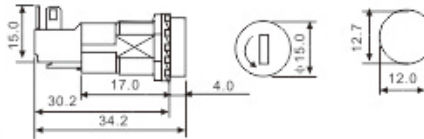

R3-12

- Material:
- Frame and cap: phenolic (UL flame: 94V-1)
- Terminal: nickel plated brass.
- Mounted by nut

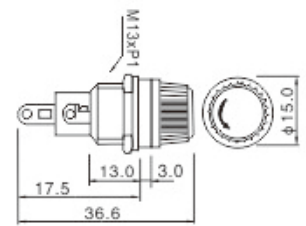

汽車保險絲及座子 Automobile fuses&holders



MINI 32V Blade Fuse
Amps (A): 2, 3, 4, 5, 7.5, 10, 15, 20, 25, 30



ATO 32V Blade Fuse
Amps (A): 1 - 5, 7.5, 10, 15, 20, 25, 30, 35, 40



MAXI 32V Blade Fuse
Amps (A): 2, 3, 4, 5, 7.5, 10, 15, 20, 25, 30



MEGA 32V Bolt-Down Fuse
Amps (A): 40 A - 500A



MIDI 32V Bolt-Down Fuse
Amps (A): 23 A - 200A



Inline Splash Proof Fuse Holder
for ATO Style Blade Fuse



Inline Splash Proof Fuse Holder
for MINI Style Blade Fuse



Inline Splash Proof Fuse Holder
for ATO Style Blade Fuse

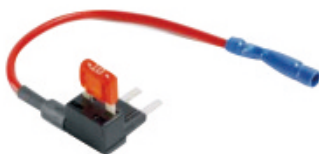

Blade Fuse Holder -Add-A-Circuit
Amps (A): 1A-40A, for MINI/ATO fuse



SL-703C, Max 30A 32V
for ATO Blade Type Fuse



東莞市瑞邁電子科技有限公司

Dongguan Reomax Electronics Co., Ltd.

廣東省東莞市大嶺山鎮大塘村地塘嶺工業園
Ditangling Industrial Park, Dalingshan Town,
Dongguan, Guangdong, China

銷售熱綫: 0769-88030405

Overseas Sales: +86-769-89018181

TEL:0769-85634648 FAX:0769-85635648

[Http://www.reomaxfuse.com](http://www.reomaxfuse.com)

瑞卓電子(香港)有限公司

Reomax Electronics (HK) Limited

香港九龍旺角大道33號凱途大廈15樓

15th floor, bright way tower, NO.33 mong kok road, kowloon, HK.

X-ON Electronics

Largest Supplier of Electrical and Electronic Components

Click to view similar products for [Surface Mount Fuses](#) category:

Click to view products by [Reomax](#) manufacturer:

Other Similar products are found below :

[FHC20402ADTP](#) [NFVC6125S0R50TRF](#) [SFT-125MA](#) [TF16SN2.00TTD](#) [FCC16501ABTP](#) [FCC16102ABTP](#) [FHC16322ADTP](#) [0308.250UR](#)
[0308.375UR](#) [0308.500UR](#) [0308.750UR](#) [0308001.UR](#) [030801.5UR](#) [F0603G0R03FNTR](#) [SKY87604-12](#) [SKY87604-11](#) [SKY87604-13](#)
[R451003.L](#) [R451.500L](#) [R451001.L](#) [3-103-119](#) [3-103-123](#) [SGB401](#) [SGB075](#) [0154002.DRL](#) [0154008.DRL](#) [0154.500DRL](#) [189140.1,25](#)
[189140.0,8](#) [189140.0,4](#) [189140.0,63](#) [189140.0,25](#) [0402FA-R200](#) [0402SFF150F/24-2](#) [0435.250KRHFS](#) [0468003.WR](#) [0494001.NRHF](#)
[0494002.NRHF](#) [0494003.NRHF](#) [049402.5NRHF](#) [049403.5NRHF](#) [0494.250NRHF](#) [0494.375NRHF](#) [0494.500NRHF](#) [CF06V3T1R60](#)
[CF06V3T2R50](#) [06H1300D](#) [JFC0603-1200FS](#) [CP06V3T2R0](#) [06F-0200L1](#)