

GSM Remote Control System

Features

- Two way remote control Via SMS Text
- Easy to install and configure using only SMS text message
- No PC required.
- 2 digital inputs (volt free)
- 2 Relay Changeover contacts rated 240Vac 5A
- Expandable to 16 Inputs 16 Outputs
- Optional external temperature measurements
- User can set inputs and outputs names
- Worldwide quad-band GSM.

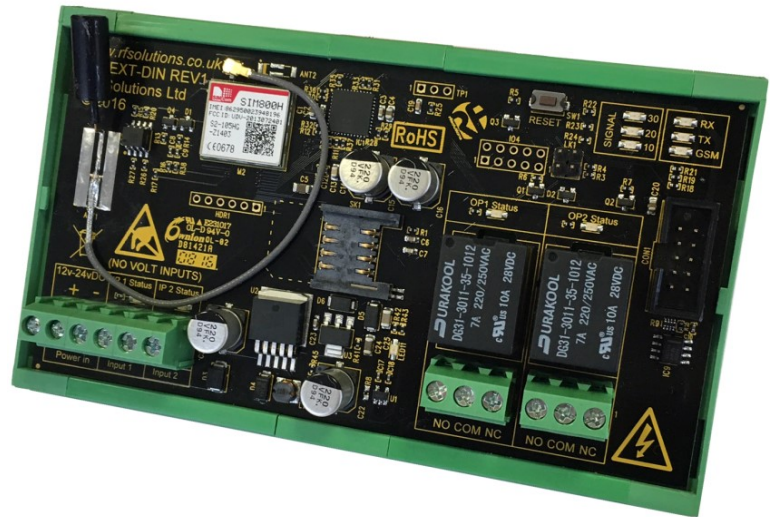

Applications

- Plant Maintenance, warnings / Alarms/ Reset.
- Irrigation Systems.
- Security Systems
- Heating Control
- Alert / Panic caller

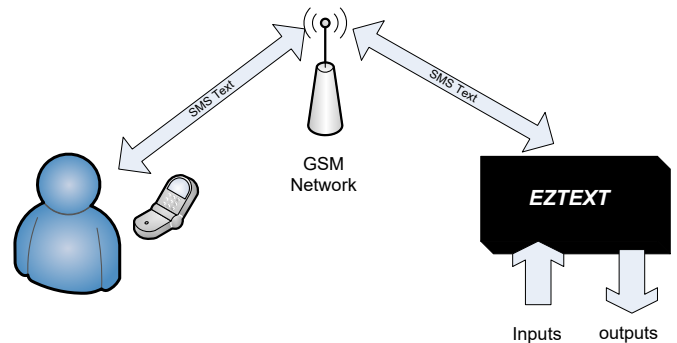

Description

EZTEXT-DIN is a two way Remote Control System which is operated by sending an SMS text message. It will also send an SMS text to upto five numbers on activation of its inputs or temperature triggers. It provides two changeover contact switches and two 'no volt' switch detect inputs which are expandable via plug-in modules.

The user can give names to Inputs/outputs and create Custom messages. Setup is easy with a few simple SMS Text Commands.

Additional Input and Output Modules

The Add-on Modules simply plug into the EZTEXT Connector socket. Once connected the EZTEXT automatically recognizes them and the additional inputs and outputs become available to use in the Text commands just the same as the two onboard Inputs and outputs.

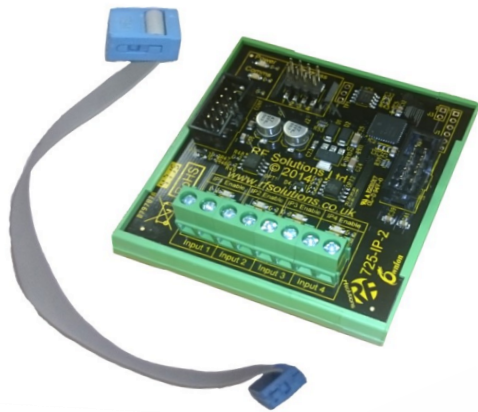

4 x Inputs Module

- 4 x Additional No-Volt Inputs
- Plug 'n' Play using ribbon cable supplied
- Up to 4 additional Input Modules can be Daisy Chained to provide 16 additional Inputs

| Part Number | Description |
|-------------|-----------------------|
| 725-IP | 4 input Add-on Module |

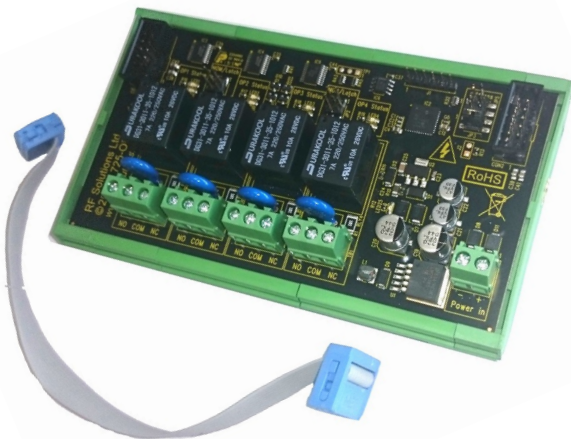

4 x Relay Output Module

- 4 x Relay Changeover Contacts
- Connecting ribbon cable supplied
- Up to four Output Modules can be Daisy Chained to provide an additional 16 Outputs.
- Up to 16 725-OP can be Daisy Chained with VCC linked.
- Provides a simple extension to the number of Inputs

| Part Number | Description |
|-------------|------------------------|
| 725-OP | 4 Output Add-on Module |

Temperature Measurement Probe Cable

Using the cable adaptor CBA-EZTEMP provides a 1metre plug in cable with temperature probe. This enables the EZTEXT temperature monitor temperature and automatically send notification of high and low user selectable trigger level.



| Part Number | Description |
|-------------|------------------------|
| CBA-EZTEMP2 | 4 Output Add-on Module |

Optional External Antenna

Using an external antenna can provide a better signal reception than the internal antenna. Using Cable adaptor CBA-UFLSMA provides a panel mounted SMA connector for external antenna connection.

To connect, carefully unplug the existing antenna UFL and push on the CBA-UFLSMA UFL connector.

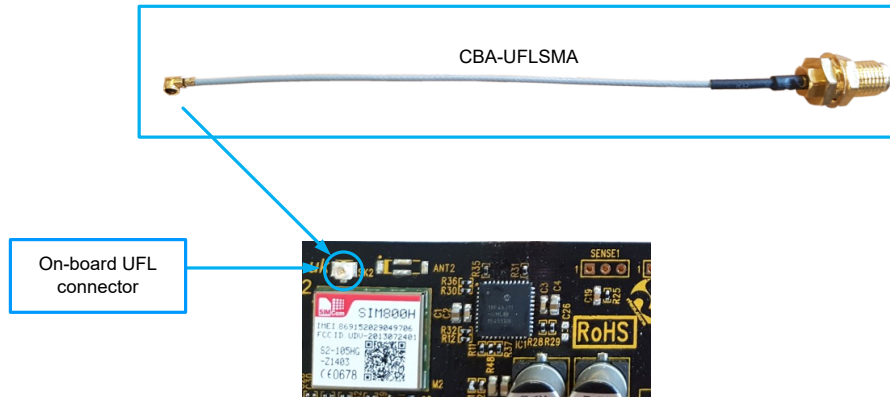

ANT-GSM5WM

A compact PCB Antenna for GSM Cellular applications where high performance is required from a small size. Using the ANT-GSMQB will give optimum range and reliability to your application.

ANT-GSMPUKS-IP67

A compact Antenna for GSM applications where high performance is required from a small size. The antenna includes a Low Noise Amplifier and is housed in a rugged low profile UV resistant case, this antenna is compact and resistant to Vandalism.



Alternative Antenna

We offer an extensive range of GSM antenna in many shapes and sizes please see our Website or contact our Sales Dept with your requirements and we will try to help

Ordering Information

| PART No | Description |
|--------------|-------------------------------------|
| EZTEXT-DIN | DIN Rail SMS control system |
| PSU-12V1A-IP | Power supply IP67 |
| CBA-EZTEMPR2 | Temperature sensor cable |
| CBA-UFLSMA | Cable assembly for external antenna |

Insert SIM Card

Please note:

- Insert NANO SIMCard before applying power (standard 3 Volt SIM only).
- **The message memory of the SIM card should be clear before it is fitted.**
- **Ensure that the SIM card has not been PIN code protected!**
- Beware of Pay-as-you-go SIM which require regular top-up to remain active.
- It is recommended to bar Incoming voice calls to the SIM card to avoid error messages being sent back to the user. This can be achieved by calling the service provider.

The SIM card should be inserted into EZTEXT-DIN before applying power

- RF Solutions recommends O2 and Vodafone SIM card and has carried out extensive testing using the SIM cards we have for these two networks.
- Problems have been identified with Orange SIM cards with this product.
- No guarantee can be given for the operation of this product with any network except those that have been tested by RF Solutions.

Connect Inputs/Outputs and Power Connections

The EZTEXT-DIN unit can be powered from 12 to 24Vdc



LED Indication At Start Up

| Logging onto Network (traffic light sequence) | | | | | | |
|--|--------------------------|--------------------------|--------------------------|--------------------------|--------------------------|--------------------------|
| 30 | | <input type="checkbox"/> | <input type="checkbox"/> | | <input type="checkbox"/> | <input type="checkbox"/> |
| 20 | <input type="checkbox"/> | | <input type="checkbox"/> | <input type="checkbox"/> | | <input type="checkbox"/> |
| 10 | <input type="checkbox"/> | <input type="checkbox"/> | | <input type="checkbox"/> | <input type="checkbox"/> | |

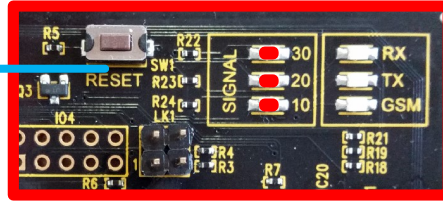

| Error! (All Flash ON / OFF together) | | | | | | |
|---|--|--------------------------|--|--------------------------|--|--------------------------|
| 30 | | <input type="checkbox"/> | | <input type="checkbox"/> | | <input type="checkbox"/> |
| 20 | | <input type="checkbox"/> | | <input type="checkbox"/> | | <input type="checkbox"/> |
| 10 | | <input type="checkbox"/> | | <input type="checkbox"/> | | <input type="checkbox"/> |

Error - No GSM Service

1. Check SimCard
2. Check Antenna Connection

LED Indication After Start Up (Normal Operation)

| Signal Strength | | |
|-----------------|----|------|
| Good | OK | Poor |
| | | |

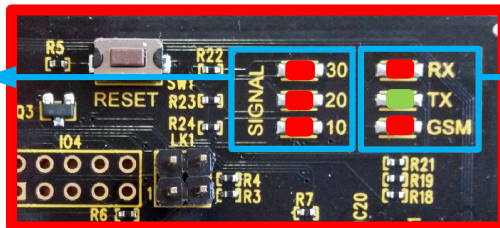

| Activity LED's | |
|----------------|--------------------------------|
| RX | Receiving an SMS |
| TX | Transmitting an SMS |
| GSM | Intermittent flash GSM healthy |

725-IP Additional 4 Inputs Module

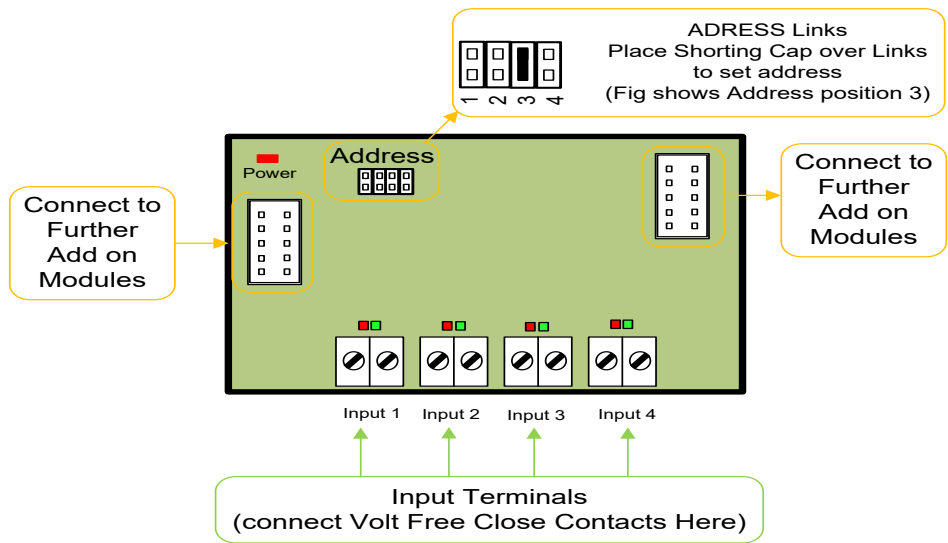

725-OP Additional 4 Outputs Module

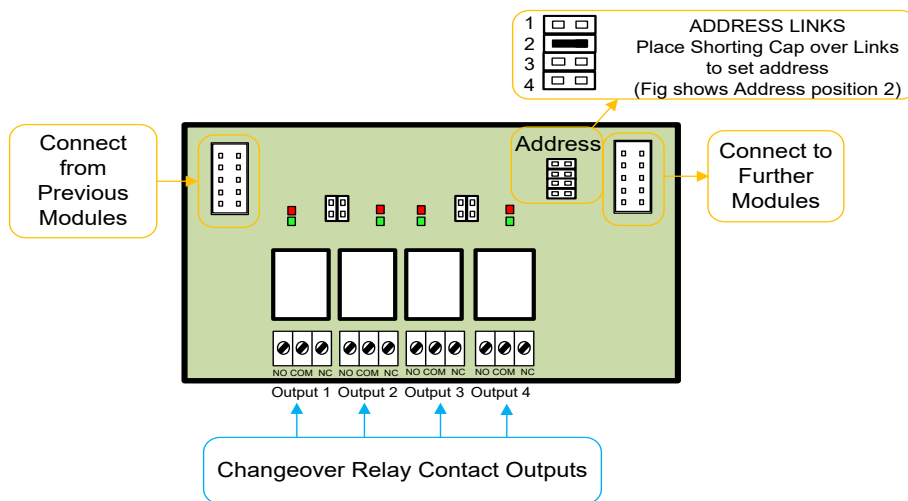

Using Additional Input / Output Modules

Input and Output modules can be added by simply plugging in the supplied Ribbon cables.
On initial Powerup EZTEXT automatically interrogates and configures additional modules. (all LEDES Flash).

After approx. 60seconds the LEDs stop flashing to indicate the module is ready to use

Notes:

1. A Maximum of four, 4-Inputs Modules and four 4-Output modules can be added in any position in the 'Daisy Chan' link (8 modules in total)
2. To avoid operator confusion additional modules have limited functions:
 3. Input modules can only be Switched (Open or closed contact) additional functions such as counting and time delays cannot be used.
 4. Output modules can only be switched ON and OFF (functions such as Time delays and counts cannot be set)
5. Each Input / Output Module requires its ADDRESS Jumper link to be set.
6. Ensure all Input modules have a unique address Link fitted 1-4, and all output modules have a unique address Link fitted 1-4.
7. For example if using one input and one output module they can both be set to address Link 1, but using two output modules the address must be different.
8. Inputs and Outputs are automatically denoted as per the table below

| Address Link | Input Name | Output Name |
|--------------|--------------|--------------|
| 1 | IP3 to IP6 | OP3 to OP6 |
| 2 | IP7 to IP10 | OP7 to OP10 |
| 3 | IP11 to IP14 | OP11 to OP14 |
| 4 | IP15 to IP18 | OP15 to OP18 |

Using EZTEMPR2 Thermocouple

Attach the Thermocouple cable to the Connector marked "SENSE"

This is now ready to use

Notes:

1. Temperatures are measured to 1 Decimal point
2. Temperature Triggers can be set to whole number values only
3. A hysteresis of -2°C is built into the EZTEXT

Example1

SET TEMP MAX is set to $+30^{\circ}\text{C}$

As the actual temperature measured increases, EZTEXT will trigger 'over Temperature' at 30.1°C

As the actual temperature measured decreases EZTEXT will trigger at 27.9°C

Example2

SET TEMP MIN is set to $+10^{\circ}\text{C}$

As the actual temperature measured decreases, EZTEXT will trigger 'under Temperature' at 9.9°C

As the actual temperature measured increases EZTEXT will trigger 'Good' at 12.1°C

Text Message Commands

Error Messages & Factory Reset

There are three error messages;

| | |
|------------------------------|--|
| NO AUTHORISATION | Means that EZTEXT did not accept the password |
| UNRECOGNIZED COMMAND | Password correct but the command is incorrect |
| UNRECOGNIZED VARIABLE | Password and command OK but the variable data is incorrect |

Factory reset

Hold down the RESET button for approx10 seconds until all LEDs flash, then release. This will reset EZTEXT to factory default settings and restart.

User Set-Up Commands

| Title | Command | Description | Example |
|----------------------|-------------------------------------|---|---|
| Password | UPW | <p>UPW#UNITPW User must send UPW command within 5 mins after power applied. Setting the UPW is carried out by sending this text message to the unit.</p> <p>The User Password (4 – 8 Characters) is case sensitive and can consist of any letters or numbers. If for any reason the unit password is lost, remove all power for 1 minute, and then start again.</p> | <p>UPW#1234 (sets password to 1234)</p> <p>Response: UPW OK</p> |
| Unit identity | UID | <p>UNITPW#UID#UNITID This sets the 'identity' of the EZTEXT unit, and will be included in any response text from EZTEXT. The UNITID can be 4 to 10 characters.</p> | <p>1234#UID#Door Alarm</p> <p>Response: Door Alarm UID OK</p> |
| Response | RESPONSE RESPONSE? | <p>UNITPW#RESPONSE#x Setup a Reply Text EZTEXT after receiving a command x=ON or OFF</p> <p>UNITPW#RESPONSE? Requests the status of the current RESPONSE setting</p> <p>NOTE: messages which specifically demand a response such as requests for input status will always be responded to as will the UPW, UID etc. Default setting is for response to be turned off.</p> | <p>1234#RESPONSE#ON Turns on Response messages</p> <p>1234#RESPONSE? Replies with the EZTEXT setting to responses</p> |

INPUT Commands

| Title | Command | Description | Example |
|---|--|---|--|
| Set an input name | <p>IPNAME</p> <p>IPNAME?</p> | <p>When the input changes this is the name that the EZTEXT will transmit in its text message</p> <p>UNITPW#IPNAMEn#<name> This designates a <name> to an EZTEXT input (max15 characters) n=1 - 4 for inputs1 to 4</p> <p>UNITPW#IPNAME? Requests the name given to all inputs</p> | <p>1234#IPNAME1,Gate Sets input 1 to be known as 'Gate'</p> <p>1234#IPNAME? Requests the current name of input1</p> |
| Input number to text | <p>IPNUM</p> <p>IPNUM?n</p> <p>IPNUMDEL</p> | <p>Sets the destination phone number(s) (max 5 per input) when an EZTEXT input is activated.</p> <p>UNITPW#IPNUMn,<num to text> n=1 - 4 for inputs1 to 4</p> <p>UNITPW#IPNUM?n Requests all Stored cell Nos for that input</p> <p>UNITPW#IPNUMDELn n=1 - 4 for inputs1 to 4 Deletes all stored cell Nos for that input number</p> | <p>1234#IPNUM1,00441234567891 Sets tel No to input 1</p> <p>1234#IPNUM?1 Requests all stored telephone numbers for input 1</p> <p>1234#IPNUMDEL2 Deletes ALL stored numbers for input 2</p> |
| Set number of input activations before SMS sent | <p>IPCNT</p> <p>IPCNTVAL?</p> | <p>Sets the number of times an input must be activated before an SMS is sent</p> <p><UNITPW#IPCNTn,x n= input number (1 or 2) x= Counter (0 to 65500)</p> <p>UNITPW#IPCNTVAL? Requests the actual current value of the counter</p> | <p>1234#IPCNT1,10 A text will be sent after input 1 has been activated 10 times</p> <p>1234#IPCNTVAL? Responds with ; INPUT1= 10/4 input1 has been activated 4 times, 6 more activations required before text is sent</p> |
| Delay SMS on input activation | <p>IPDLY</p> <p>IPDLY?</p> | <p>Sets a timer (Max 65500 secs). When the EZTEXT input is activated the timer starts to countdown in seconds. When the counter reaches zero, providing the input is still activated a text message will be sent.</p> <p>UNITPW#IPDLYn,xx n=1 - 4 for inputs1 to 4 'xx' can be a number from 0 to 65500</p> <p>UNITPW#IPDLY? Requests timer values for all inputs</p> | <p>1234#IPDLY1,60 Input 1 has a 60sec delay before text is sent</p> <p>1234#IPDLY? Responds with ; INPUT1= 60/34 (output1 has been active fro 34 out of a total 60sec preset time. 34secs more is required before text sent)</p> |

Output Commands

| Title | Command | Description | Example |
|--------------------|-----------------------|---|---|
| Activate an output | OUT | Turns an output ON or OFF UNITPW#OUTn,x n=Relay number = 1 to 4 x=Relay Status = ON, OFF | 1234#OUT1,ON Turns Output1 ON |
| Set an output name | OPNAME OPNAME? | This designates a name to an EZTEXT output UNITPW#OPNAMEn,name n=Output no name= name can be up to 15 characters. UNITPW#OPNAME? Requests the name of the Outputs | 1234#OPNAME1,AIRCON sets output 1 name to be 'AIRCON' 1234#OPNAME? Requests names of all the outputs |
| Set output on time | OPDLY OPDLY? | Sets output operation time. The output can be set from 1 to 65500 seconds, or If is set to '0', then the output will latch on UNITPW#OPDLYn,t n=Output number t=Delay time (seconds) UNITPW#OPDLY? Requests the current 'on' time setting for an output EZTEXT replies with the preset time delay output and the actual time that the output has been activated for | 1234#OPDLY1,500 Sets output1 to operate for 500 sec's 1234#OPDLY? Responds with ; OUTPUT1= 500/34 (output1 has been active for 34 out of a total 500sec preset time) |

Power Fail Commands

| Title | Command | Description | Example |
|---------------------------------|-------------------------------------|--|---|
| Number to text on power failure | PFNUM PFNUM? PFNUMDEL | This command sets a number to text (max 5 nos) when Power Failed (only if optional battery fitted) UNITPW#PFNUM#<numbertotext> Sets the number to text on power fail UNITPW#PFNUM? Requests the current numbers that are stored UNITPW#PFNUMDEL PFNUMDEL Deletes all stored Power Failed cell Nos | 1234#PFNUM#0044127389 8000 1234 #PFNUM? Response: Returns current settings 1234 #PFNUMDEL Deletes all stored cell Nos against this |
| Text on power re-stored | | UNIT ID#Reboot power had failed Texts will be sent to cell phone numbers stored in IPNUM on reboot after a power failure or reset (when power is reapplied). Note: this feature is enabled or disabled by simply having cell phone numbers in PNUM. | Building2 Reboot power had failed |

Temperature Commands

| Command | Description | Description | Example |
|------------------------------------|---|--|---|
| Request current temperature | TEMP? | UNITPW#TEMP? requests the current temperature. | 1234# TEMP? |
| Set SMS numbers to text on trigger | TEMPNUM TEMPNUM? TEMPNUM-DEL | UNITPW#TEMPNUM#<numbertotext> Sets the cell phone nos (max of 5) linked with the temperature monitoring. TEMPNUM? Requests all linked cell phone nos TEMPNUMDEL Deletes all linked cell phone nos | 1234#TEMPNUM#00441234567891 Sets the number 01234567891 1234#TEMPNUM? Requests all cell phone numbers which will be notified on temp triggers 1234#TEMPNUMDEL Deletes all the telephone numbers associated with Temperature monitoring |
| Set maximum trigger temperature | SETTEMPMAX | UNITPW#SETTEMPMAX#n Sets the maximum temperature trigger level in degrees Celsius. | 1234#SETTEMPMAX#30 Sets the upper trigger level to 30°C |
| Set maximum trigger temperature | SETTEMPMIN | UNITPW#SETTEMPMIN#n Sets the minimum temperature trigger level. | 1234#SETTEMPMIN#20 Sets the lower trigger level to 20°C |

13. System Commands

| Title | Command | Description | Example |
|---------------------------------------|---------------|---|---|
| Report GSM signal strength | SIGQ | UNITPW#SIGQ Reports EZTEXT GSM signal strength as: 'POOR' (consider alternative antenna) 'OK', or 'Good'. | 1234#SIGQ Response : Signal is good |
| Retrieve status of inputs and outputs | STATUS | UNITPW#STATUS requests the current status of all inputs and outputs | 1234#STATUS Response: Returns current settings |

Technical Specifications

Storage Temperature: -10 to +70°C.
Operating Temperature: 0 to +55°C.
EZTEXT Dimensions: 136 x 78 x 42 mm

| Electrical Characteristics* | Min | Typical | Max | Dimension | Notes |
|-----------------------------------|-----|---------|-----|-----------|-------|
| Supply Voltage | 12 | | 24 | V | |
| Supply Current for EZTEXT: | | | | | |
| Idle | 24 | 35 | 45 | mA | 1 |
| Operating | 200 | 250 | 2A | mA | 2 |
| Closed Contact Input Time | 100 | | | mSecs | |
| Temperature Cable | -55 | | 110 | °C | 3 |
| Mains rated Relay Rating (230Vac) | | 5 | 12 | A | 4 |

*Notes

Figures refer to maximum supply current required with all components idle.
 Figures refer to peak supply current required with all components operating.
 In practice internal reservoir capacitance limits the instantaneous peak current to less than 500 mA.
 Temperature accuracy
 +/- 0.5 degrees between -10 to +80-degree Centigrade
 +/- 2.0 degrees between -55 to +110-degree Centigrade

The relay contacts in this unit are for functional switching only and must not be used for isolation purposes.

Important European compliance information

This RF Solutions product meets the essential requirements of the European Radio Equipment Directive 2014/53/EU and has been tested to European Harmonised Standards and CE marked accordingly. A copy of the EU Declaration of Conformity can be located on the RF Solutions Website,

www.rfsolutions.co.uk/certification-i59.

RF Solutions Ltd. Recycling Notice

Meets the following EC Directives:

DO NOT

Discard with normal waste, please recycle.



ROHS Directive 2002/95/EC

Specifies certain limits for hazardous substances.

WEEE Directive 2002/96/EC

Waste electrical & electronic equipment. This product must be disposed of through a licensed WEEE collection point. RF Solutions Ltd., fulfills its WEEE obligations by membership of an approved compliance scheme.

Disclaimer:

Whilst the information in this document is believed to be correct at the time of issue, RF Solutions Ltd does not accept any liability whatsoever for its accuracy, adequacy or completeness. No express or implied warranty or representation is given relating to the information contained in this document. RF Solutions Ltd reserves the right to make changes and improvements to the product(s) described herein without notice. Buyers and other users should determine for themselves the suitability of any such information or products for their own particular requirements or specification(s). RF Solutions Ltd shall not be liable for any loss or damage caused as a result of user's own determination of how to deploy or use RF Solutions Ltd's products. Use of RF Solutions Ltd products or components in life support and/or safety applications is not authorised except with express written approval. No licences are created, implicitly or otherwise, under any of RF Solutions Ltd's intellectual property rights. Liability for loss or damage resulting or caused by reliance on the information contained herein or from the use of the product (including liability resulting from negligence or where RF Solutions Ltd was aware of the possibility of such loss or damage arising) is excluded. This will not operate to limit or restrict QuasarUK Ltd's liability for death or personal injury resulting from its negligence.

X-ON Electronics

Largest Supplier of Electrical and Electronic Components

Click to view similar products for [Mobile Modules](#) category:

Click to view products by [RF Solutions](#) manufacturer:

Other Similar products are found below :

[SIM7100A 4G/LTE KIT](#) [EZTEXT](#) [CB410L](#) [XBC-M5-UT-001](#) [GSM-EXP](#) [MPCIE-3G-R10](#) [M100CDMA485-V](#) [M100CDMAPLUS-V](#)
[SC1905A-00A00](#) [NRF9160-SIAA-B1A-R7](#) [NRF9160-SIBA-B1A-R7](#) [nRF9160-SICA-R7](#) [ONE523MEA](#) [T523MEA](#) [2701344](#)
[EG91NAXGA-128-SGNS](#) [EG91NSGA-512-SGNS](#) [EG91EFB-512-SNND](#) [SARA-R412M-02B](#) [MT100EOCG-G2-SP](#) [MTSMC-G2-V.R1](#)
[MTSMC-G2-IP.R1](#) [MTSMC-G2-V-ED.R1](#) [ASB-EX15-XC18-GLB](#) [ASB-EX15-XX06-GLB](#) [ASB-EX15-XX06-OUS](#) [SKY77643-11](#)
[SKY77768-11](#) [SKY77764-11](#) [SKY77765-11](#) [SARA-R510M8S-00B](#)