

2A, Low Input Voltage, Ultra-Low Dropout LDO Regulator with Enable

General Description

The RT2516 is a high performance positive voltage regulator designed for use in applications requiring ultra-low input voltage and ultra-low dropout voltage at up to 2 amperes. It operates with an input voltage as low as 1.4V, with output voltage programmable as low as 0.5V. The RT2516 features ultra low dropout, ideal for applications where output voltage is very close to input voltage. Additionally, the RT2516 has an enable pin to further reduce power dissipation while shutdown. The RT2516 provides excellent regulation over variations in line, load and temperature. The RT2516 is available in the SOP-8 (Exposed Pad) package. The output voltage can be set by an external divider depending on how the FB pin is configured.

Ordering Information

RT2516 □□

- Package Type
SP : SOP-8 (Exposed Pad-Option 2)
- Lead Plating System
G : Green (Halogen Free and Pb Free)

Note :

Richtek products are :

- ▶ RoHS compliant and compatible with the current requirements of IPC/JEDEC J-STD-020.
- ▶ Suitable for use in SnPb or Pb-free soldering processes.

Features

- Input Voltage as Low as 1.4V
- Ultra-Low Dropout Voltage 400mV @ 2A
- Over Current Protection
- Over Temperature Protection
- 1μA Input Current in Shutdown Mode
- Enable Control
- RoHS Compliant and Halogen Free

Applications

- Telecom/Networking Cards
- Motherboards/Peripheral Cards
- Industrial Applications
- Wireless Infrastructure
- Set Top Box
- Medical Equipment
- Notebook Computers
- Battery Powered Systems

Pin Configurations

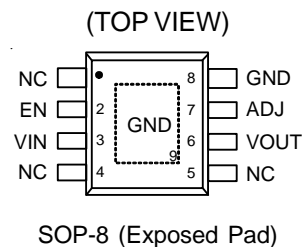

Simplified Application Circuit

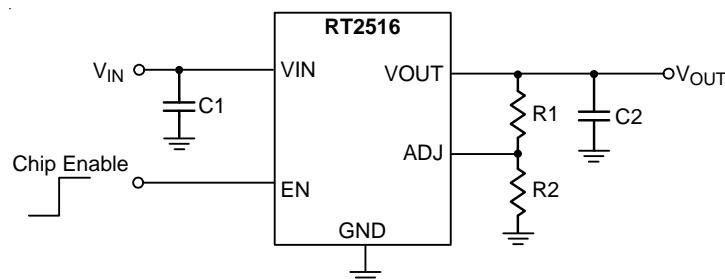

Marking Information

RT2516 GSPYMDNN •

RT2516GSP : Product Number

YMDNN : Date Code

Functional Pin Description

Pin No.	Pin Name	Pin Function
1, 4, 5	NC	No Internal Connection.
2	EN	Chip Enable (Active-High). Pulling this pin below 0.4V to turn the regulator off. The device will be enabled if this pin is left open. Connect to VIN for controlling by VIN.
3	VIN	Power Input. For regulation at full load, the input to this pin must be between (VOUT + 0.5V) and 6V. Minimum input voltage is 1.4V. A large bulk capacitance should be placed closely to this pin to ensure that the input supply does not sag below 1.4V. A minimum of 10µF ceramic capacitor should be placed directly at this pin.
6	VOUT	Output of the Regulator. A minimum of 10µF capacitor should be placed directly at this pin.
7	ADJ	Feedback Voltage Input. If connected to the VOUT pin, the output voltage will be set at 0.5V. If external feedback resistors are used, the output voltage will be determined by the resistor ratio.
8, 9 (Exposed pad)	GND	Ground. The exposed pad must be soldered to a large PCB and connected to GND for maximum power dissipation.

Function Block Diagram

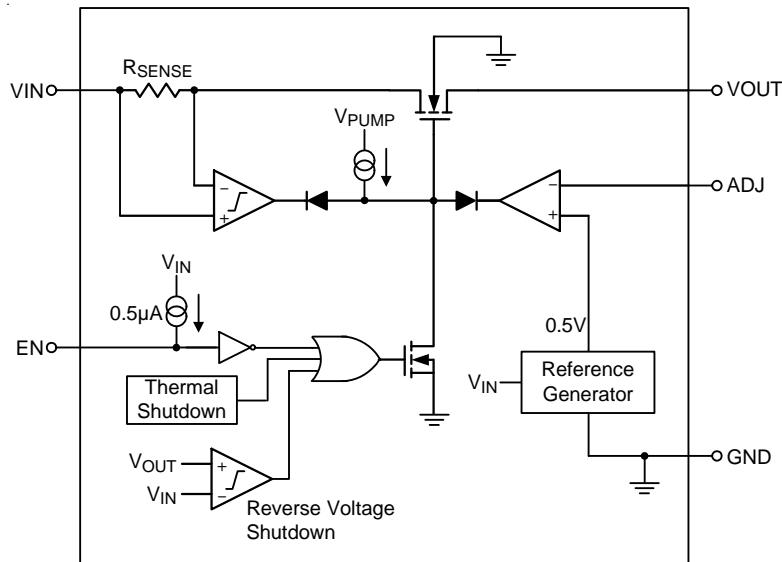

Absolute Maximum Ratings (Note 1)

- Supply Voltage, V_{IN} ----- 0.3V to 7V
- Other Pins ----- 0.3V to 7V
- Power Dissipation, P_D @ $T_A = 25^\circ\text{C}$
 SOP-8 (Exposed Pad) ----- 2.500W
- Package Thermal Resistance (Note 2)
 SOP-8 (Exposed Pad), θ_{JA} ----- 40°C/W
 SOP-8 (Exposed Pad), θ_{JC} ----- 8°C/W
- Lead Temperature (Soldering, 10 sec.) ----- 260°C
- Junction Temperature ----- 150°C
- Storage Temperature Range ----- -65°C to 150°C
- ESD Susceptibility (Note 3)
 HBM (Human Body Model) ----- 2kV
 CDM (Charged Device Model) ----- 1kV

Recommended Operating Conditions (Note 4)

- Supply Voltage, V_{IN} ----- 1.4V to 6V
- Junction Temperature Range ----- -40°C to 125°C
- Ambient Temperature Range ----- -40°C to 105°C

Electrical Characteristics

($V_{IN} = 1.4\text{V}$ to 6V , $I_{OUT} = 10\mu\text{A}$ to 2A , $V_{ADJ} = V_{OUT}$, $-40^\circ\text{C} \leq T_A \leq 105^\circ\text{C}$, unless otherwise specified)

Parameter	Symbol	Test Conditions	Min	Typ	Max	Unit
Quiescent Current	I_Q	$V_{IN} = 3.3\text{V}$, $I_{OUT} = 0\text{A}$	--	0.7	1.5	mA
Shutdown Current	I_{SHDN}	$V_{IN} = 6\text{V}$, $V_{EN} = 0\text{V}$	--	1.5	10	μA
Line Regulation	ΔV_{LINE}	$I_{OUT} = 10\text{mA}$	--	0.2	0.4	%/V
Load Regulation	ΔV_{LOAD}	$I_{OUT} = 10\text{mA}$ to 2A	--	0.5	1.5	%
Dropout Voltage	V_{DROP}	$I_{OUT} = 1\text{A}$, $V_{IN} \geq 1.6\text{V}$	--	120	200	mV
		$I_{OUT} = 1\text{A}$, $1.4\text{V} < V_{IN} < 1.6\text{V}$	--	--	400	
		$I_{OUT} = 1.5\text{A}$, $V_{IN} \geq 1.6\text{V}$	--	180	300	
		$I_{OUT} = 1.5\text{A}$, $1.4\text{V} < V_{IN} < 1.6\text{V}$	--	--	500	
		$I_{OUT} = 2\text{A}$, $V_{IN} \geq 1.6\text{V}$	--	240	400	
		$I_{OUT} = 2\text{A}$, $1.4\text{V} < V_{IN} < 1.6\text{V}$	--	--	600	
Current Limit	I_{LIM}	$V_{IN} = 3.3\text{V}$	2.3	3	4.4	A
Feedback						
ADJ Reference Voltage	V_{REF}	$V_{IN} = 3.3\text{V}$, $V_{ADJ} = V_{OUT}$, $I_{OUT} = 10\text{mA}$, $T_A = 25^\circ\text{C}$	0.495	--	0.505	V
		$V_{IN} = 3.3\text{V}$, $V_{ADJ} = V_{OUT}$, $I_{OUT} = 10\text{mA}$	0.4925	--	0.5075	
ADJ Pin Current	I_{ADJ}	$V_{ADJ} = 0.5\text{V}$	--	20	200	nA

Parameter	Symbol	Test Conditions	Min	Typ	Max	Unit	
Enable							
EN Pin Current	I_{EN}	$V_{EN} = 0V, V_{IN} = 6V$	--	1	10	μA	
EN Threshold Voltage	Logic-High	V_{IH}	$V_{IN} = 3.3V$	1.6	--	--	V
	Logic-Low	V_{IL}	$V_{IN} = 3.3V$	--	--	0.4	
Over Temperature Protection							
OTP Trip Level			--	160	--	$^{\circ}C$	
Hysteresis			--	30	--	$^{\circ}C$	

Note 1. Stresses beyond those listed “Absolute Maximum Ratings” may cause permanent damage to the device. These are stress ratings only, and functional operation of the device at these or any other conditions beyond those indicated in the operational sections of the specifications is not implied. Exposure to absolute maximum rating conditions may affect device reliability.

Note 2. θ_{JA} is measured in the natural convection (air flow = 0 ft/min) at $T_A = 25^{\circ}C$ on a highly thermal conductive four-layer test board of JEDEC 51-7 thermal measurement standard. The test board size is 75.6mm x 114.3mm (3"x4.5") with 1.6mm thickness FR4 refer to JEDEC 51 standard. The test board exist four-layer copper, 2oz. (0.07mm) thickness. The case point of θ_{JC} is on the expose pad for SOP-8 (Exposed Pad) package. The copper area of top copper plane is about 100mm².

Note 3. Devices are ESD sensitive. Handling precaution is recommended.

Note 4. The device is not guaranteed to function outside its operating conditions.

Typical Application Circuit

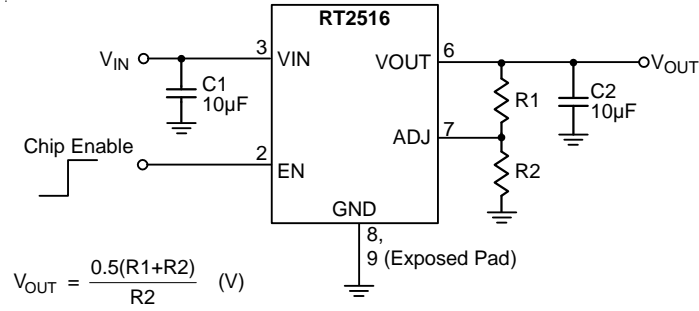

Typical Operating Characteristics

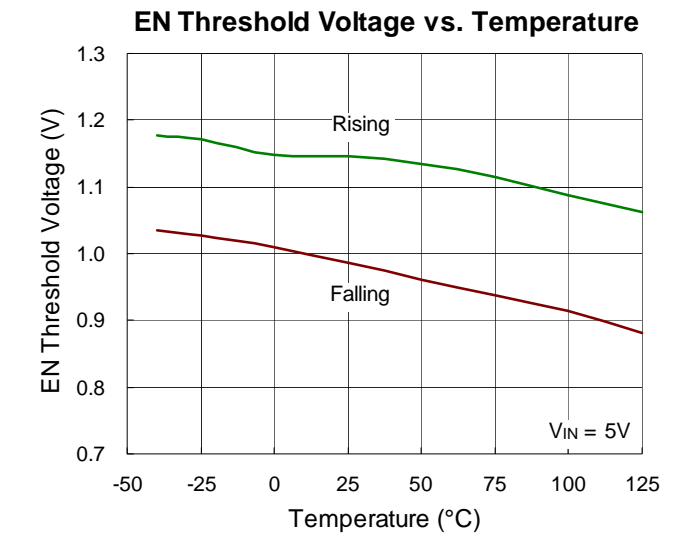
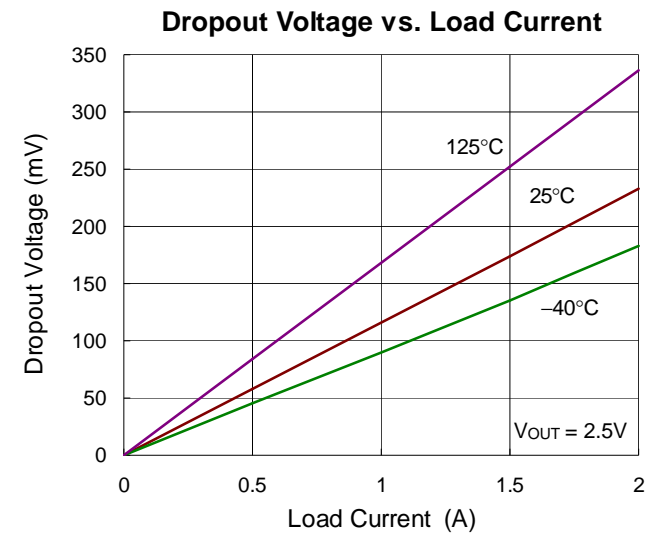
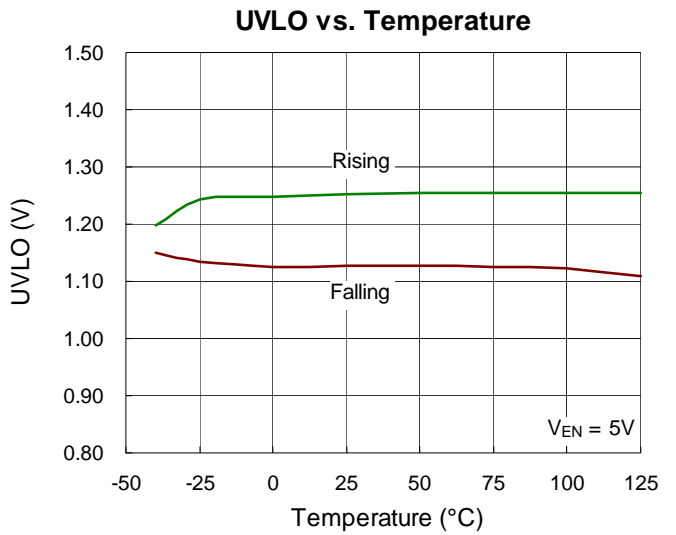
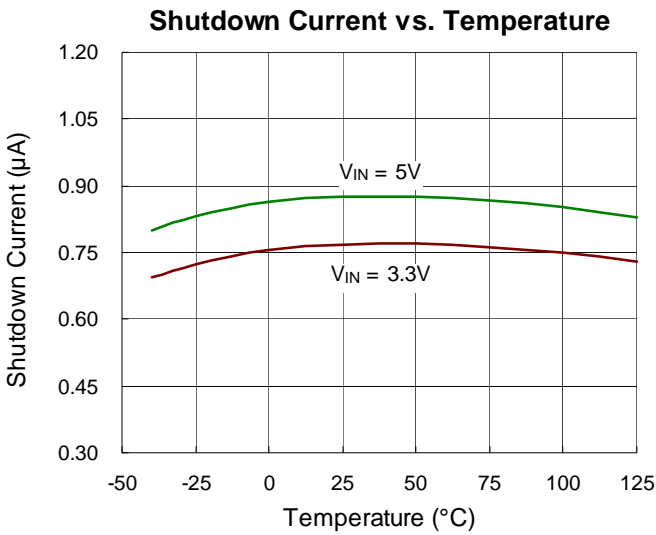
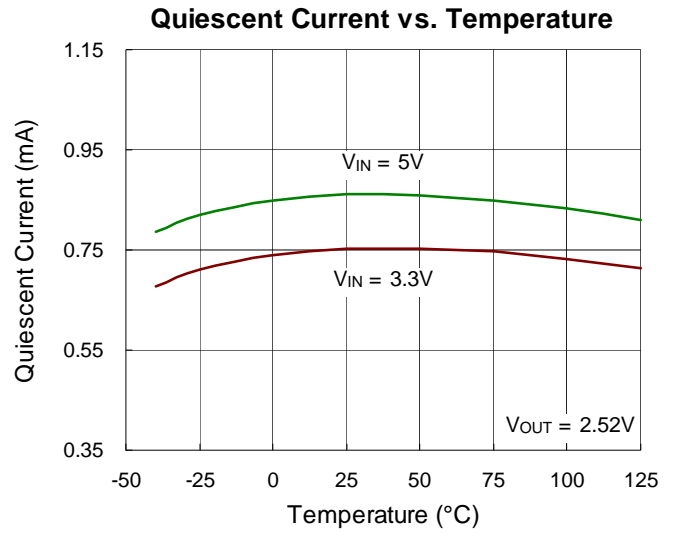
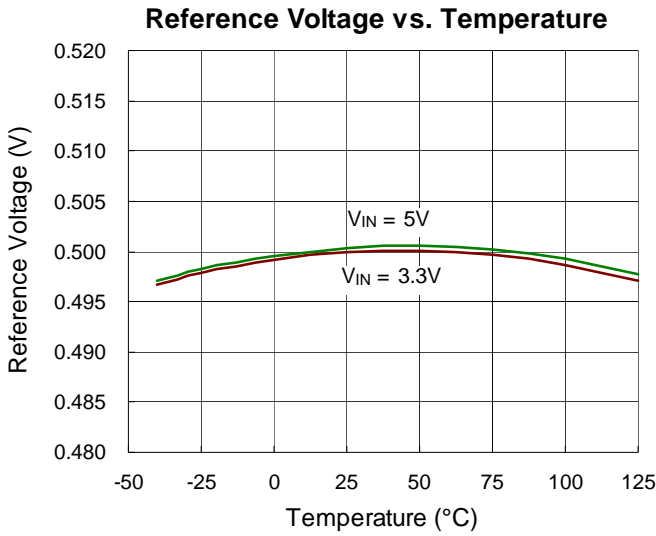

Load Transient Response

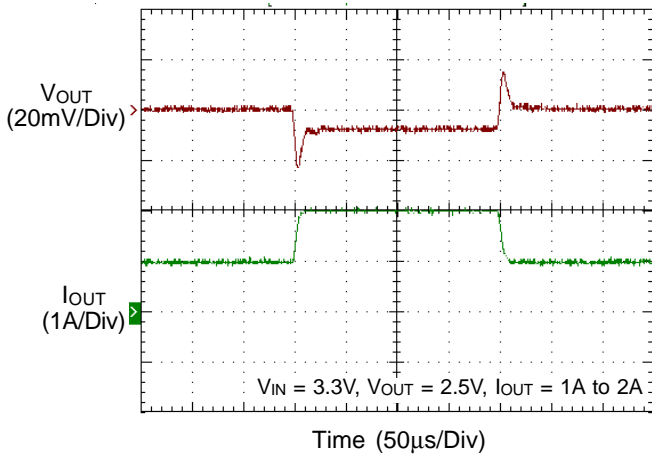

Line Transient Response

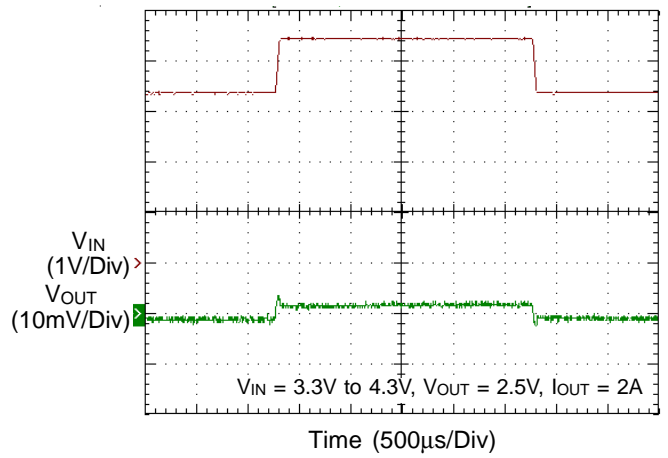

Power On from EN

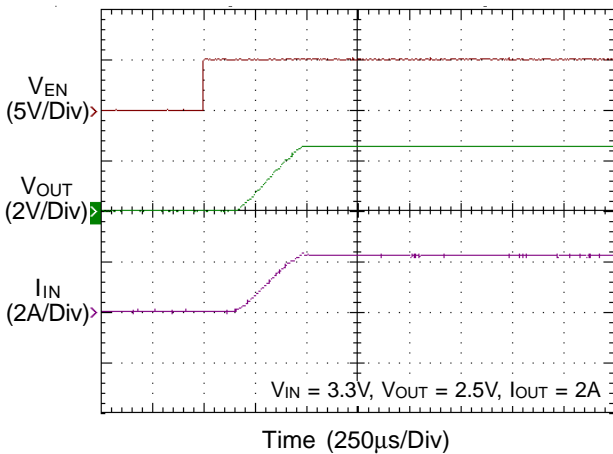

Power Off from EN

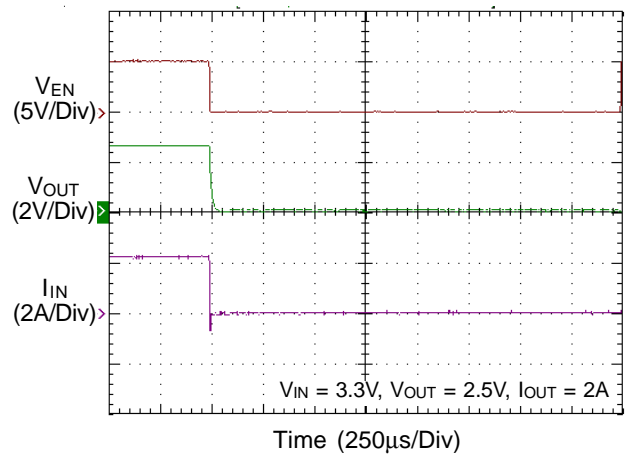

PSRR

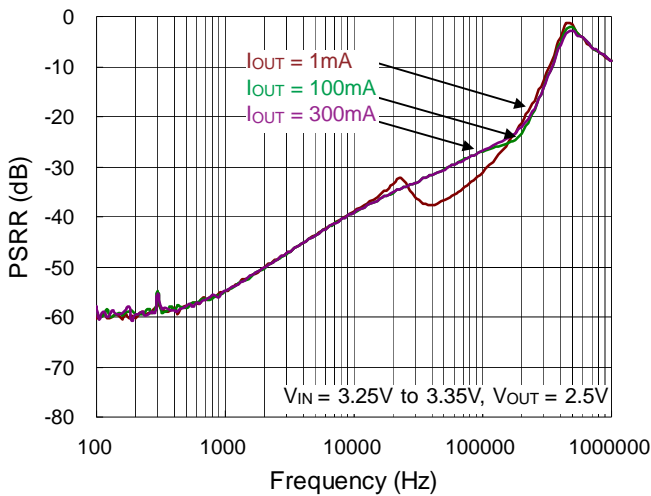

VEN Rising vs. Input Voltage

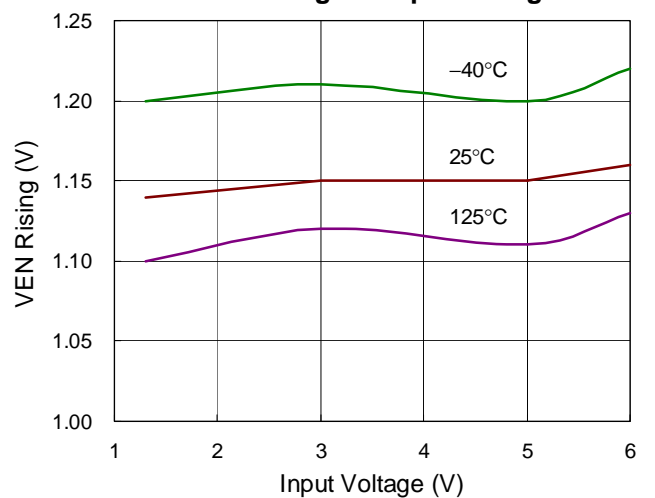

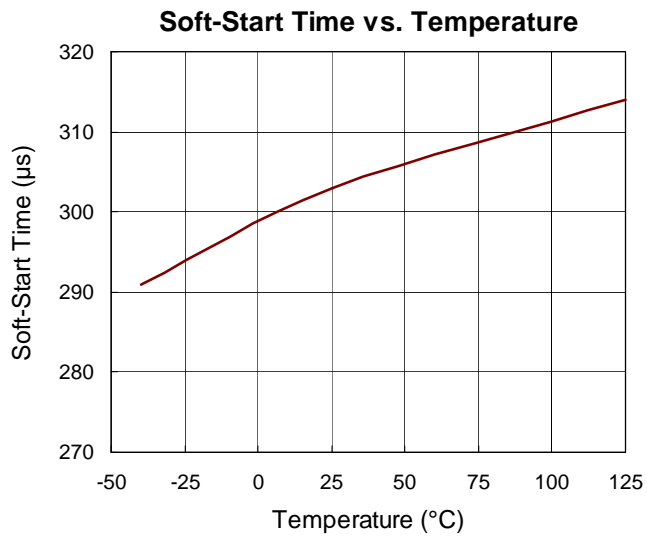

Application Information

The RT2516 is a low voltage, low dropout linear regulator with an external bias supply input capable of supporting an input voltage range from 1.4V to 6V with a fixed output voltage from 1V to 2V in 0.1V increments.

Output Voltage Setting

The RT2516 output voltage is adjustable from 1.4V to 6V via the external resistive voltage divider. The voltage divider resistors can have values of up to 800kΩ because of the very high impedance and low bias current of the sense comparator. The output voltage is set according to the following equation :

$$V_{OUT} = V_{REF} \times \left(1 + \frac{R1}{R2}\right)$$

where V_{REF} is the reference voltage with a typical value of 0.5V.

Chip Enable Operation

The RT2516 goes into sleep mode when the EN pin is in a logic low condition. In this condition, the pass transistor, error amplifier, and band gap are all turned off, reducing the supply current to only 10μA (max.). The EN pin can be directly tied to VIN to keep the part on.

Current Limit

The RT2516 contains an independent current limit circuitry, which monitors and controls the pass transistor's gate voltage, limiting the output current to 3A (typ.).

C_{IN} and C_{OUT} Selection

Like any low dropout regulator, the external capacitors of the RT2516 must be carefully selected for regulator stability and performance. Using a capacitor of at least 10μF is suitable. The input capacitor must be located at a distance of not more than 0.5 inch from the input pin of the IC. Any good quality ceramic capacitor can be used. However, a capacitor with larger value and lower ESR (Equivalent Series Resistance) is recommended since it will provide better PSRR and line transient response.

The RT2516 is designed specifically to work with low ESR ceramic output capacitor for space saving and performance consideration. Using a ceramic capacitor with capacitance of at least 10μF and ESR larger than 1mΩ on the RT2516 output ensures stability. Nevertheless, the RT2516 can still work well with other types of output capacitors due to its wide range of stable ESR. Figure 1 shows the allowable ESR range as a function of load current for various output capacitance. Output capacitors with larger capacitance can reduce noise and improve load transient response, stability, and PSRR. The output capacitor should be located at a distance of not more than 0.5 inch from the output pin of the RT2516.

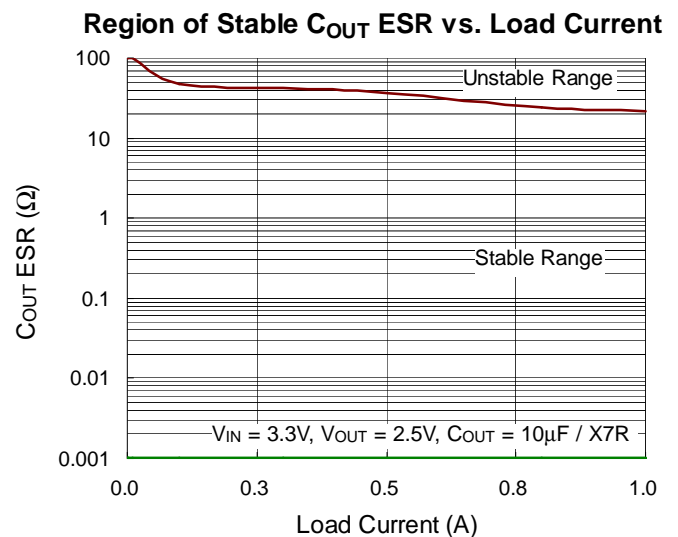

Figure 1

Thermal Considerations

Thermal protection limits power dissipation in RT2516. When the operation junction temperature exceeds 160°C, the OTP circuit starts the thermal shutdown function and turns the pass element off. The pass element turns on again after the junction temperature cools by 30°C.

RT2516 output voltage will be closed to zero when output short circuit occurs as shown in Figure 2. It can reduce the IC temperature and provides maximum safety to end users when output short circuit occurs.

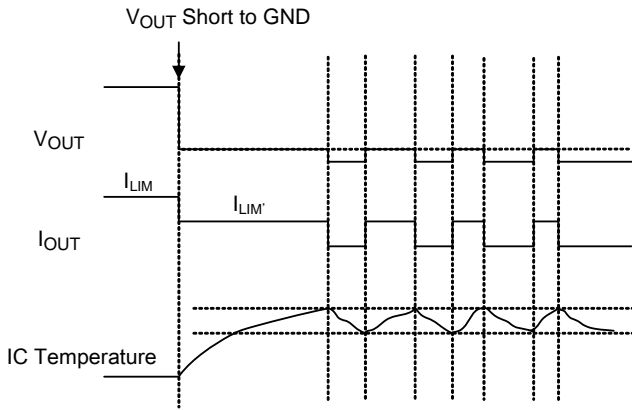

Figure 2. Short Circuit Protection when Output Short Circuit Occurs

For continuous operation, do not exceed absolute maximum junction temperature. The maximum power dissipation depends on the thermal resistance of the IC package, PCB layout, rate of surrounding airflow, and difference between junction and ambient temperature. The maximum power dissipation can be calculated by the following formula :

$$P_{D(MAX)} = (T_{J(MAX)} - T_A) / \theta_{JA}$$

where $T_{J(MAX)}$ is the maximum junction temperature, T_A is the ambient temperature, and θ_{JA} is the junction to ambient thermal resistance.

For recommended operating condition specifications, the maximum junction temperature is 125°C. The junction to ambient thermal resistance, θ_{JA} , is layout dependent. For SOP-8 (Exposed Pad) package, the thermal resistance, θ_{JA} , is 40°C/W on a standard JEDEC 51-7 four-layer thermal test board. The maximum power dissipation at $T_A = 25^\circ\text{C}$ can be calculated by the following formula :

$$P_{D(MAX)} = (125^\circ\text{C} - 25^\circ\text{C}) / (40^\circ\text{C/W}) = 2.500\text{W}$$

SOT-8 (Exposed Pad) package

The maximum power dissipation depends on the operating ambient temperature for fixed $T_{J(MAX)}$ and thermal resistance, θ_{JA} . The derating curve in Figure 3 allows the designer to see the effect of rising ambient temperature on the maximum power dissipation.

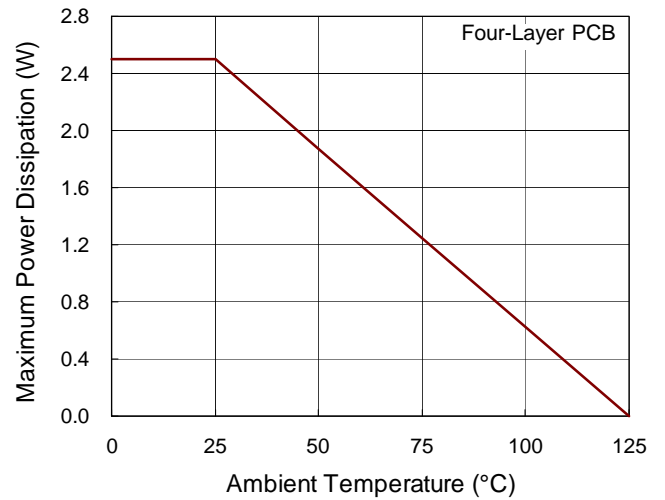
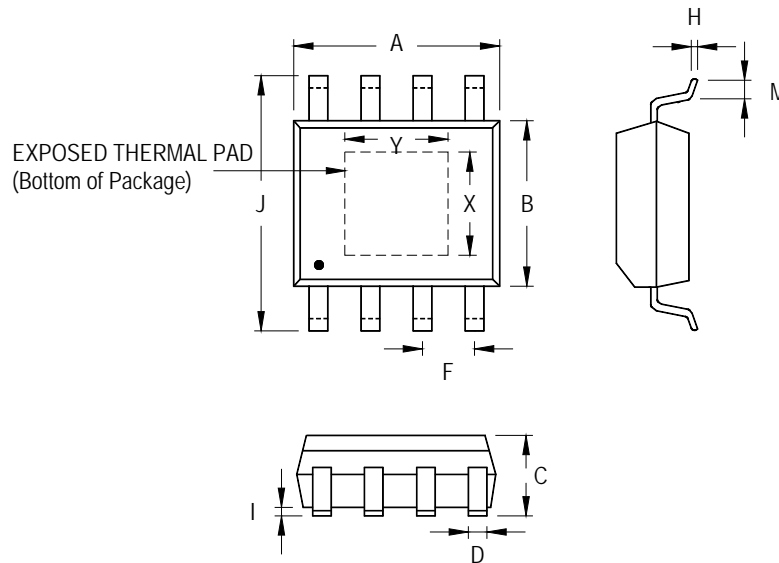

Figure 3. Derating Curve of Maximum Power Dissipation

Outline Dimension



Symbol	Dimensions In Millimeters		Dimensions In Inches		
	Min	Max	Min	Max	
A	4.801	5.004	0.189	0.197	
B	3.810	4.000	0.150	0.157	
C	1.346	1.753	0.053	0.069	
D	0.330	0.510	0.013	0.020	
F	1.194	1.346	0.047	0.053	
H	0.170	0.254	0.007	0.010	
I	0.000	0.152	0.000	0.006	
J	5.791	6.200	0.228	0.244	
M	0.406	1.270	0.016	0.050	
Option 2	X	2.100	2.500	0.083	0.098
	Y	3.000	3.500	0.118	0.138

8-Lead SOP (Exposed Pad) Plastic Package

Richtek Technology Corporation

14F, No. 8, Tai Yuen 1st Street, Chupei City
 Hsinchu, Taiwan, R.O.C.
 Tel: (8863)5526789

Richtek products are sold by description only. Richtek reserves the right to change the circuitry and/or specifications without notice at any time. Customers should obtain the latest relevant information and data sheets before placing orders and should verify that such information is current and complete. Richtek cannot assume responsibility for use of any circuitry other than circuitry entirely embodied in a Richtek product. Information furnished by Richtek is believed to be accurate and reliable. However, no responsibility is assumed by Richtek or its subsidiaries for its use; nor for any infringements of patents or other rights of third parties which may result from its use. No license is granted by implication or otherwise under any patent or patent rights of Richtek or its subsidiaries.

X-ON Electronics

Largest Supplier of Electrical and Electronic Components

Click to view similar products for [LDO Voltage Regulators](#) category:

Click to view products by [Richtek](#) manufacturer:

Other Similar products are found below :

[AP7363-SP-13](#) [L79M05TL-E](#) [AP7362-HA-7](#) [PT7M8202B12TA5EX](#) [TCR3DF185,LM\(CT](#) [TCR3DF45,LM\(CT](#) [TLE4473G V52](#)
[NCP4687DH15T1G](#) [701326R](#) [NCV8170AXV250T2G](#) [AP7315-25W5-7](#) [AP2111H-1.2TRG1](#) [ZLDO1117QK50TC](#) [AZ1117ID-ADJTRG1](#)
[TCR3DG12,LF](#) [MIC5514-3.3YMT-T5](#) [SCD7912BTG](#) [NCP154MX180270TAG](#) [SCD33269T-5.0G](#) [NCV8170BXV330T2G](#)
[NCV8170BMX330TCG](#) [NCV8170AMX120TCG](#) [NCP706ABMX300TAG](#) [NCP114BMX075TCG](#) [MC33269T-3.5G](#) [TCR3DG33,LF](#)
[TLE4471GXT](#) [TCR4DG35,LF](#) [TAR5S15U\(TE85L,F\)](#) [TCR3UG19A,LF](#) [TCR4DG105,LF](#) [MPQ2013AGG-5-P](#) [NCV8170AMX360TCG](#)
[AP7315-33SA-7](#) [TLE4268GSXUMA2](#) [NCP715SQ15T2G](#) [MIC5317-3.0YD5-T5](#) [NCV563SQ18T1G](#) [NCP715MX30TBG](#)
[NCV8702MX25TCG](#) [NCV8170BXV120T2G](#) [MIC5317-1.2YD5-T5](#) [NCV8170AMX150TCG](#) [NCV8170BMX150TCG](#) [AP2213D-3.3TRG1](#)
[NCV8170BMX120TCG](#) [NCV8170BMX310TCG](#) [NCV8170BMX360TCG](#) [MIC5514-1.2YMT-T5](#) [NCV8170BMX280TCG](#)