

Ultra-Low Quiescent Current HCOT Buck Converter

General Description

The RT5707/A is a high efficiency synchronous step-down converter featuring typ. 360nA quiescent current. It provides high efficiency at light load down to 10mA. Its input voltage range is from 2.2V to 5.5V. The RT5707 provides eight programmable output voltage 1.2V to 3.3V while delivering output current up to 600mA, peak to 1A. The RT5707A provides eight programmable output voltage 0.7V to 3.1V while delivering output current up to 400mA, peak to 0.5A.

The Hysteretic Constant-On-Time (HCOT) operation with internal compensation allow the transient response to be optimized over a wide range of loads and output capacitors.

The RT5707/A is available in WL-CSP-8B 0.9x1.6 (BSC) package.

Features

- Input Voltage Range : 2.2V to 5.5V
- Programmable Output Voltage 8-Level
 - RT5707 1.2V to 3.3V
 - RT5707A 0.7V to 3.1V
- Typ. 360nA Quiescent Current
- PSM Operation
- Up to 94% Efficiency
- Internal Compensation
- Output Voltage Discharge
- Over-Current Protection
- Over-Temperature Protection
- Output Current
 - RT5707 600mA, Peak to 1A
 - RT5707A 400mA, Peak to 0.5A
- Automatic Transition to 100% Duty Cycle Operation

Ordering Information

RT5707/A □
 Package Type
 WSC : WL-CSP-8B 0.9x1.6 (BSC)

Note :

Richtek products are :

- RoHS compliant and compatible with the current requirements of IPC/JEDEC J-STD-020.
- Suitable for use in SnPb or Pb-free soldering processes.

Applications

- Hand-Held Devices
- Portable Information
- Battery Powered Equipment
- Wearable Devices
- Internet of Things
- Smart Watch

Simplified Application Circuit

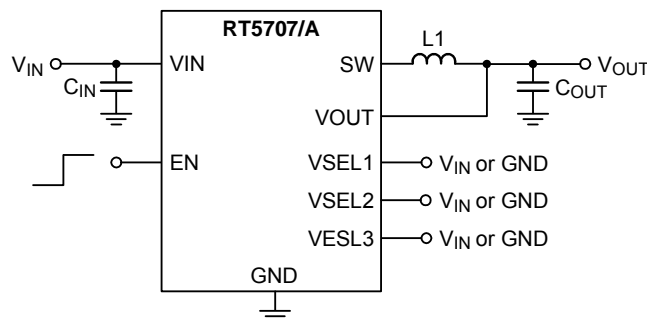

Marking Information

RT5707WSC

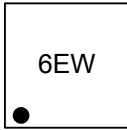

6E : Product Code
W : Date Code

RT5707AWSC

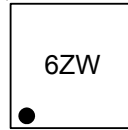

6Z : Product Code
W : Date Code

Pin Configuration

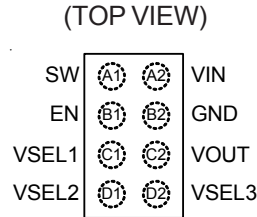

WL-CSP-8B 0.9x1.6 (BSC)

Functional Pin Description

Pin No.	Pin Name	Pin Function
A1	SW	This pin is the connection between two build-in switches in the chip, which should be connected to the external inductor. The inductor should be connected to this pin with the shortest path.
A2	VIN	Supply input. A minimum of 10 μ F (RT5707) and 4.7 μ F (RT5707A) ceramic capacitor should be connected to this pin with the shortest path
B1	EN	Chip enable input pin. High level voltage enables the device while low level voltage turns the device off. This pin must be terminated.
B2	GND	Device ground pin. This pin should be connected to input and output capacitors with the shortest path.
C1	VSEL1	Output voltage selection pin. This pin must be terminated.
C2	VOUT	Output voltage feedback pin. This pin should be connected close to the output capacitor terminal for better voltage regulation. A minimum of 10 μ F ceramic capacitor should be connected to this pin with the shortest path.
D1	VSEL2	Output voltage selection pin. This pin must be terminated.
D2	VSEL3	Output voltage selection pin. This pin must be terminated.

Functional Block Diagram

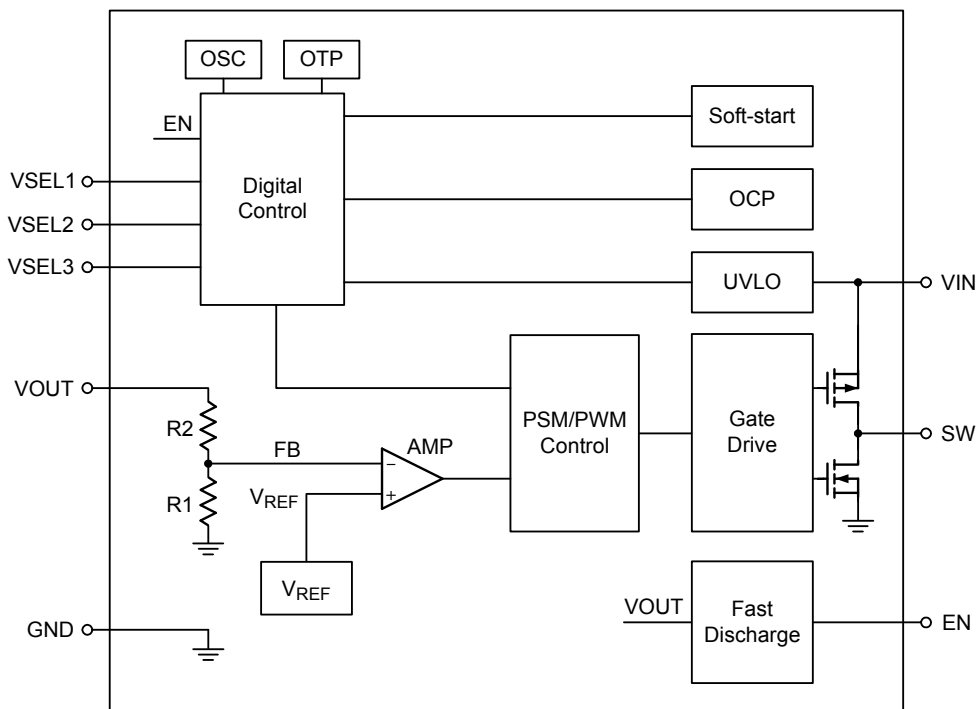

Operation

The RT5707/A is a hysteretic constant on time (HCOT) switching buck converter. The RT5707/A provides Over-Temperature Protection (OTP) and Over-Current Protection (OCP) mechanisms to prevent the device from damage with abnormal operations. When the EN voltage is logic low, the IC will be shut down with low input supply current less than 1 μ A.

Enable

The device can be enabled or disabled by the EN pin. When the EN pin is higher than the threshold of logic-high IC goes to normal operation. EN pin High transfer Low into shutdown mode, the converter stops switching, internal control circuitry is turned off and trigger discharge function. That discharge function will close after count 10ms (typ.). If systems need EN toggle operation that EN turn off time must larger than 100 μ s for internal circuit reset time.

UVLO Protection

To protect the chip from operating at insufficient supply voltage, the UVLO is needed. When the input voltage is lower than the UVLO falling threshold voltage, the device will be lockout.

100% Duty Cycle Operation

The converter enters 100% duty cycle operation once the input voltage decrease and the difference voltage between input and output is lower than V_{TH_100-} . The output voltage follows the input voltage minus the voltage drop across the internal P_MOSFET and the inductor. Once the input voltage increases and trips the 100% mode exit threshold, V_{TH_100+} , the converter backs to normal switching again. See Figure 1.

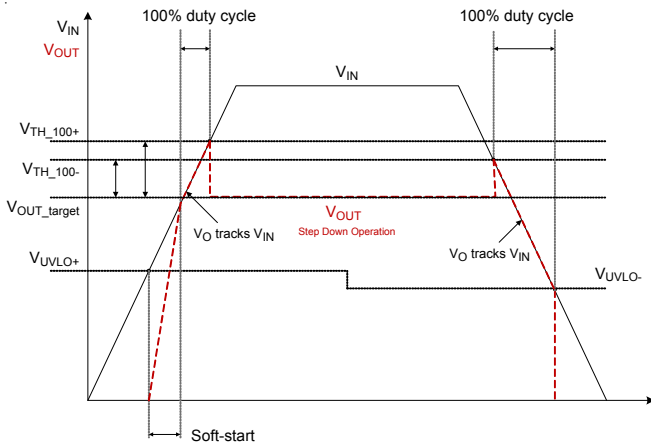

Figure 1. Automatic Transition into 100% Duty Cycle

Over-Temperature Protection

When the junction temperature exceeds the OTP threshold value, the IC will shut down the switching operation. Once the junction temperature cools down and is lower than the OTP lower threshold, the converter will automatically resume switching.

Over-Current Protection

The OCP function is implemented by UGATE and LGATE. When the inductor current reaches the UGATE current limit threshold, the high-side MOSFET will be turned-off. The low-side MOSFET turns on to discharge the inductor current until the inductor current trips below the LGATE current limit threshold. After UGATE current limit triggered, the max inductor current is decided by the inductor current rising rate and the response delay time of the internal network.

During OCP period, the output voltage drops below the setting threshold (typ. 0.4V) and the current limit value is reduced for lowering the devices loss, reducing the heat and preventing further damage of the chip.

Output Voltage Selection

The RT5707/A provides 8 level output voltages which can be programmed via the volatage select pin VSEL1 to VSEL3. Table 1 indicates the setting to individual output voltage.

Table 1. Output Voltage Setting

Device	V _{OUT} (V)	VSEL3	VSEL2	VSEL1
RT5707	1.2	0	0	0
	1.5	0	0	1
	1.8	0	1	0
	2.1	0	1	1
	2.5	1	0	0
	2.8	1	0	1
	3	1	1	0
	3.3	1	1	1
RT5707A	0.7	0	0	0
	1	0	0	1
	1.3	0	1	0
	1.6	0	1	1
	1.9	1	0	0
	2	1	0	1
	2.9	1	1	0
	3.1	1	1	1

Absolute Maximum Ratings (Note 1)

- VIN, SW, EN, VSEL1, VSEL2, VSEL3, VOUT ----- -0.3V to 6V
- Power Dissipation, P_D @ T_A = 25°C
 WL-CSP-8B 0.9x1.6 (BSC) ----- 0.84W
- Package Thermal Resistance (Note 2)
 WL-CSP-8B 0.9x1.6 (BSC), θ_{JA} ----- 118.5°C/W
- Lead Temperature (Soldering, 10 sec.) ----- 260°C
- Junction Temperature Range ----- 150°C
- Storage Temperature Range ----- -65°C to 150°C
- ESD Susceptibility (Note 3)
 HBM (Human Body Model) ----- 2kV

Recommended Operating Conditions (Note 4)

- Supply Input Voltage ----- 2.2V to 5.5V
- RT5707 Output Current (5.5V ≥ VIN ≥ (V_{OUT_NOM} + 0.7V) ≥ 3V) ----- 0mA to 600mA
- RT5707A Output Current (5.5V ≥ VIN ≥ (V_{OUT_NOM} + 0.7V) ≥ 3V) ----- 0mA to 400mA
- Junction Temperature Range ----- -40°C to 125°C
- Ambient Temperature Range ----- -40°C to 85°C

Electrical Characteristics

(VIN = 3.6V, CIN = COUT = 10μF, L1 = 2.2μH, TA = 25°C, unless otherwise specified)

Parameter	Symbol	Test Conditions	Min	Typ	Max	Unit	
BUCK Regulator							
Under-Voltage Lockout Rising Threshold	V _{UVLOR}	V _{IN} rising	--	2	2.15	V	
Under-Voltage Lockout Hysteresis	V _{UVLO_HYS}		--	0.1	0.4	V	
V _{OUT} Voltage Accuracy	V _{OUT_ACC10}	V _{OUT} = 1.8V, I _{OUT} = 10mA	-2.5	--	2.5	%	
	V _{OUT_ACC100}	V _{OUT} = 1.8V, I _{OUT} = 100mA	-2	--	2		
Input Quiescent Current	I _{Q_Non-SW}	V _{OUT} = 1.8V, I _{OUT} = 0A, EN = V _{IN} , non-switching	--	360	800	nA	
	I _{QSW}	V _{OUT} = 1.8V, I _{OUT} = 0A, EN = V _{IN} , switching	--	460	1200		
Shutdown Current	I _{SHDN}	EN = GND	--	0.2	1	μA	
Switching Frequency	f _{sw}	V _{OUT} = 1.8V, CCM mode	--	1.2	--	MHz	
UGATE Current Limit	I _{CL_UG}	3V ≤ V _{IN} ≤ 5.5V	RT5707	1	1.2	1.4	A
			RT5707A	0.68	0.78	0.88	
LGATE Current Limit	I _{CL_LG}	3V ≤ V _{IN} ≤ 5.5V	RT5707	1	1.2	1.4	A
			RT5707A	0.55	0.68	0.8	
UGATE R _{ON}	R _{ON_UG}	I _{OUT} = 50mA	--	350	--	mΩ	
LGATE R _{ON}	R _{ON_LG}	I _{OUT} = 50mA	--	250	--	mΩ	

Parameter	Symbol	Test Conditions	Min	Typ	Max	Unit
Output Discharge Resistor	R _{DIS}	EN = GND, I _{OUT} = -10mA	--	10	--	Ω
V _{OUT} Pin Input Leakage	I _{VOUT}	V _{OUT} = 2V, EN = V _{IN}	--	100	--	nA
V _{OUT} Minimum Off Time	t _{OFF_MIN}		--	80	--	ns
V _{OUT} Minimum On Time	t _{ON_MIN}	V _{OUT} = 1.8V, V _{IN} = 3.6V	--	420	--	ns
Line Regulation	V _{OUT_LineReg}	V _{OUT} = 1.8V, I _{OUT} = 100mA, V _{IN} = 2.2V to 5.5V	--	0.1	--	%/V
Load Regulation	V _{OUT_LoadReg1}	V _{OUT} = 1.8V, including PFM operation	--	0.001	--	%mA
	V _{OUT_LoadReg2}	V _{OUT} = 1.8V, only CCM operation	--	0.0005	--	
Over-Temperature Protection	T _{OTP}		--	150	--	°C
Over-Temperature Protection Hysteresis	T _{OTP_HYS}		--	20	--	°C
Auto 100% Duty Cycle Leave Detection Threshold	V _{TH_100+}	Rising V _{IN} , 100% mode is left with V _{IN} = V _{OUT} + V _{TH_100+}	150	250	350	mV
Auto 100% Duty Cycle Enter Detection Threshold	V _{TH_100-}	Falling V _{IN} , 100% mode is entered with V _{IN} = V _{OUT} + V _{TH_100-}	85	200	290	mV
Timing						
Regulator Start Up Delay Time	t _{SS_EN}	I _{OUT} = 0mA, EN = GND to V _{IN} , V _{OUT} starts rising	--	0.1	--	ms
Regulator Soft Start Time	t _{SS}	V _{OUT} = 1.8V, I _{OUT} = 10mA, EN = V _{IN}	--	0.7	--	ms
Logic Input (EN, VSEL1, VSEL2 and VSEL3)						
Input High Threshold	V _{IH}	V _{IN} = 2.2V to 5.5V	1.2	--	--	V
Input Low Threshold	V _{IL}	V _{IN} = 2.2V to 5.5V	--	--	0.4	V
Input Pin Bias Current	I _{IN}		--	10	--	nA

Note 1. Stresses beyond those listed “Absolute Maximum Ratings” may cause permanent damage to the device. These are stress ratings only, and functional operation of the device at these or any other conditions beyond those indicated in the operational sections of the specifications is not implied. Exposure to absolute maximum rating conditions may affect device reliability.

Note 2. θ_{JA} is measured under natural convection (still air) at T_A = 25°C with the component mounted on a high effective-thermal-conductivity four-layer test board on a JEDEC 51-7 thermal measurement standard.

Note 3. Devices are ESD sensitive. Handling precaution is recommended.

Note 4. The device is not guaranteed to function outside its operating conditions.

Typical Application Circuit

For the RT5707

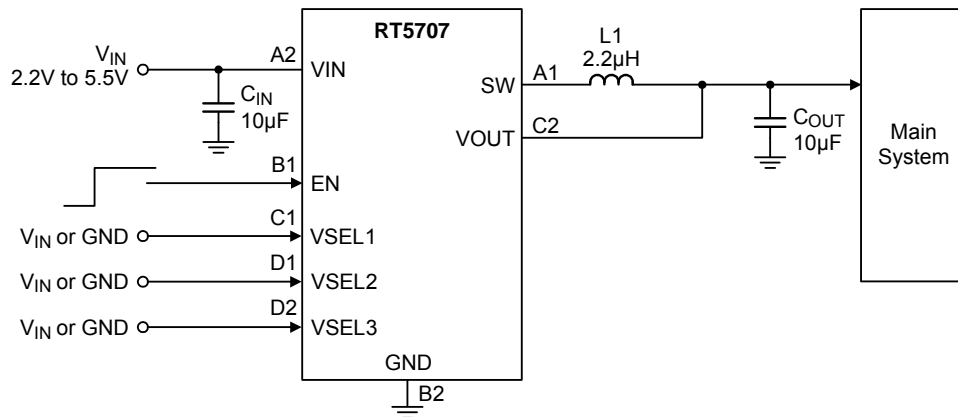

Recommended components information for the RT5707 as below table :

Reference	Part Number	Description	Package	Manufacturer
C _{IN} , C _{OUT}	GRM155R60J106ME15	10µF/6.3V/X5R	0402	Murata
L1	1239AS-H-2R2M	2.2µH	2520	Murata

For the RT5707A

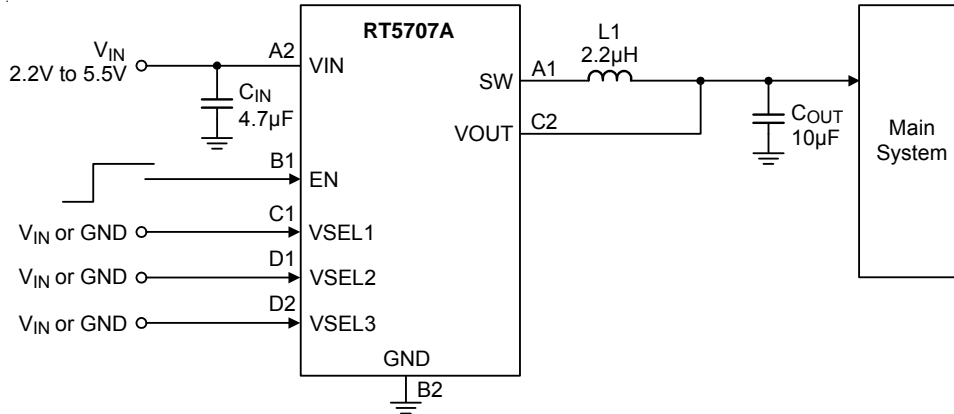

Recommended components information for the RT5707A as below table :

Reference	Part Number	Description	Package	Manufacturer
C _{IN}	GRM155R60J475ME47	4.7µF/6.3V/X5R	0402	Murata
C _{OUT}	GRM155R60J106ME15	10µF/6.3V/X5R	0402	Murata
L1	DFE201610E-2R2M=P2	2.2µH	2016	Murata

Typical Operating Characteristics

Efficiency vs. Load Current

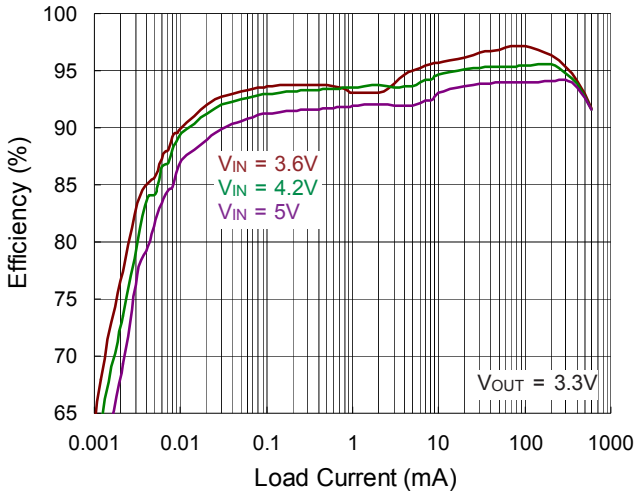

Efficiency vs. Load Current

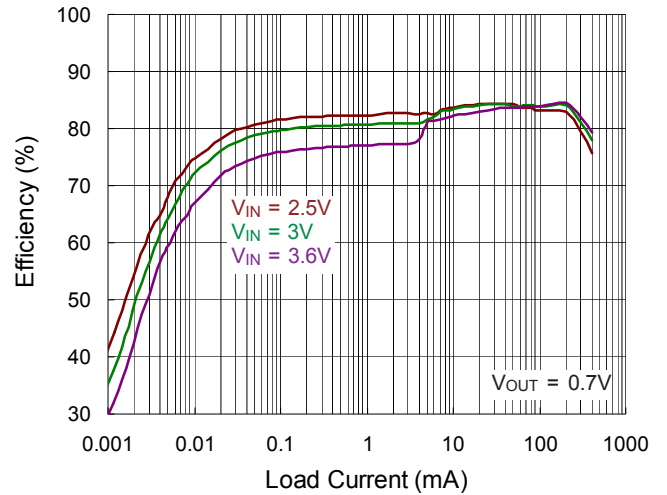

Switching Frequency vs. Load Current

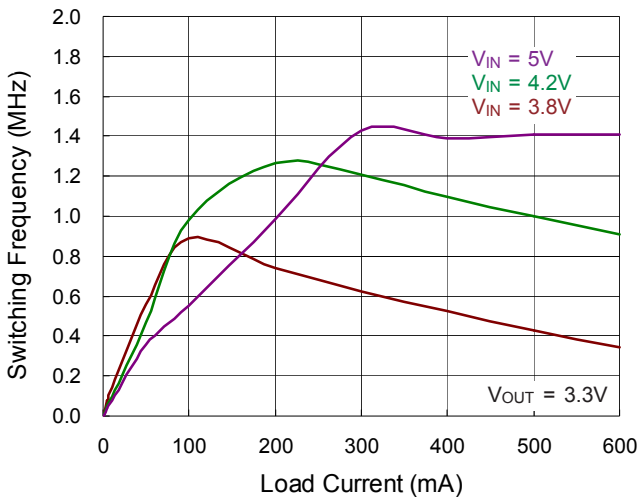

Output Voltage Ripple

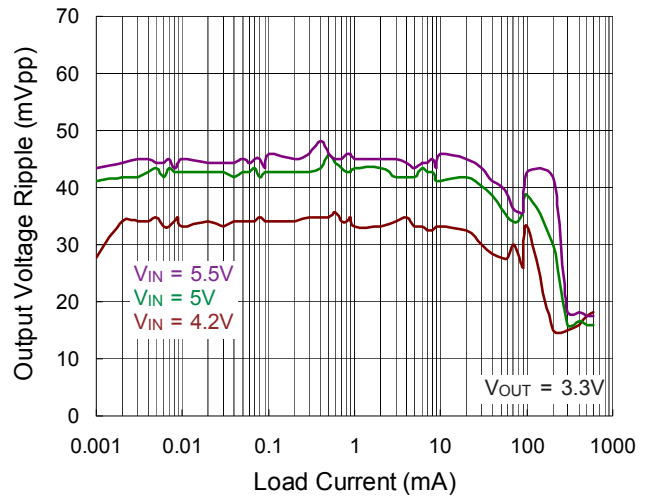

Output Voltage Ripple

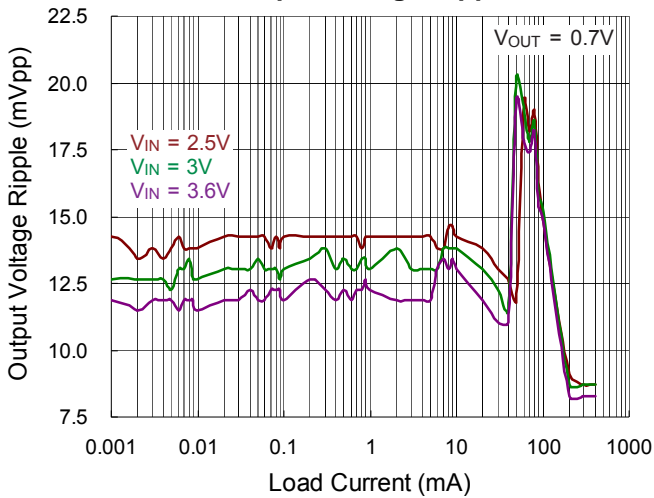

Quiescent Current

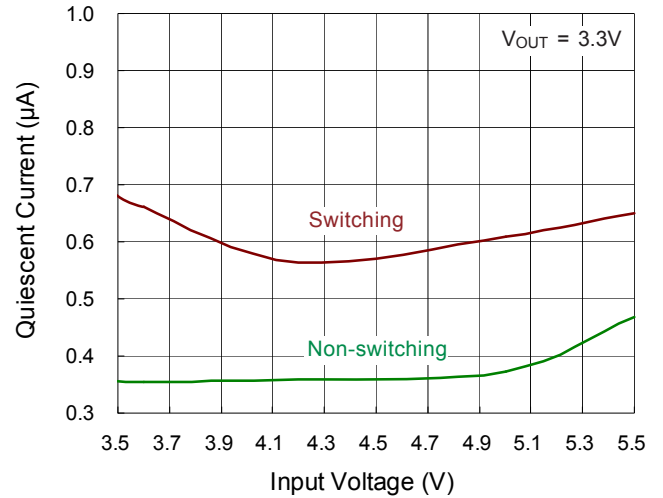

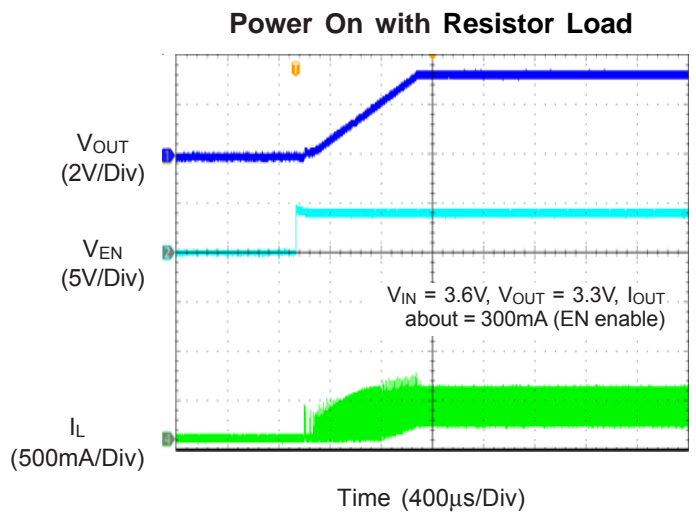
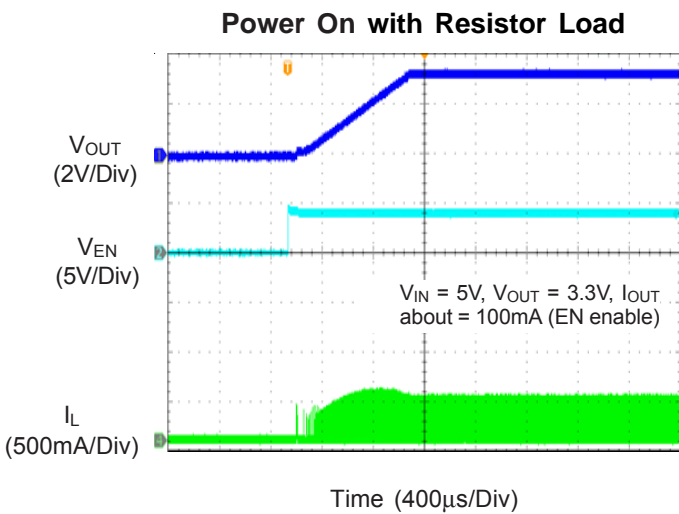
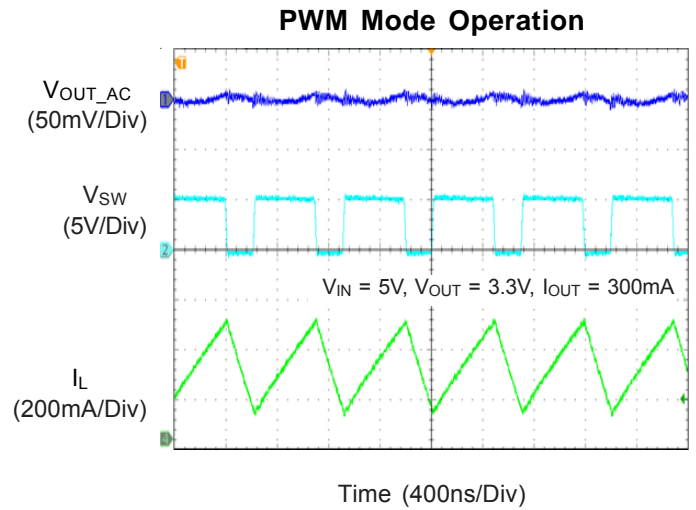
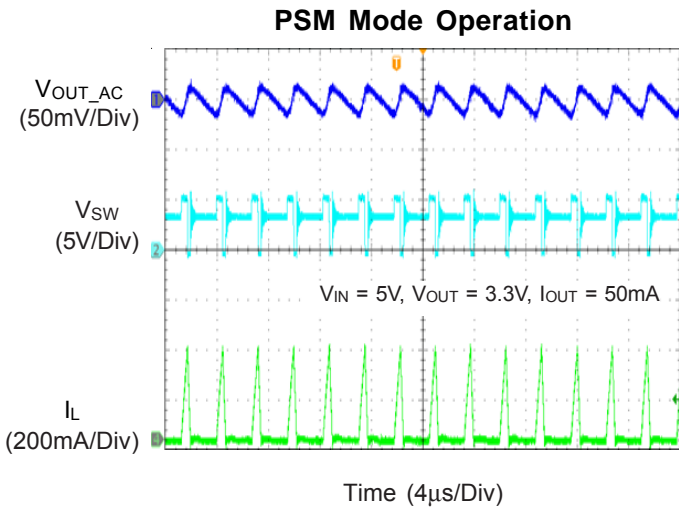
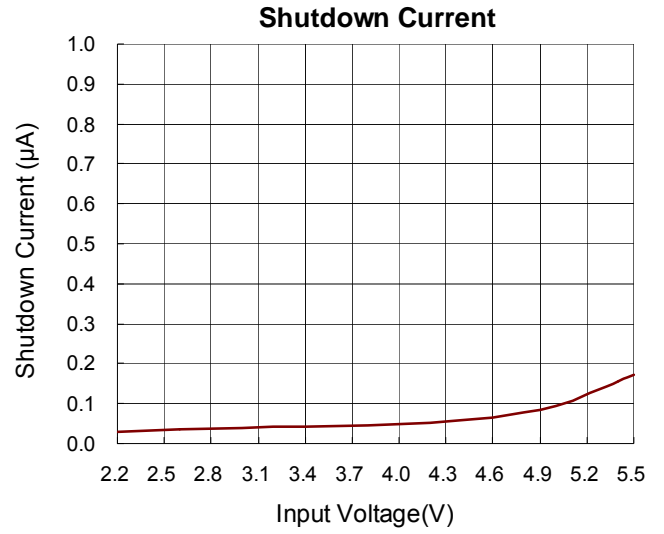
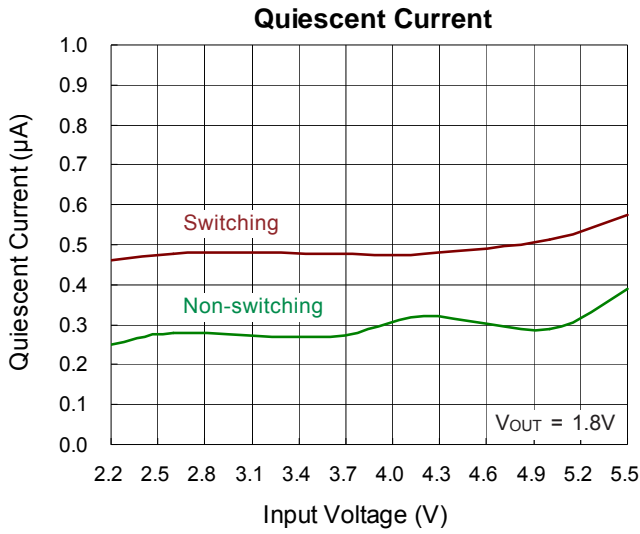

Load Transient Response

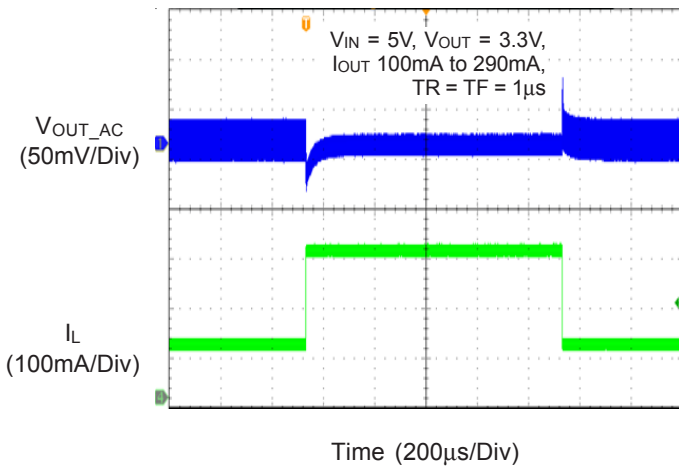

Load Transient Response

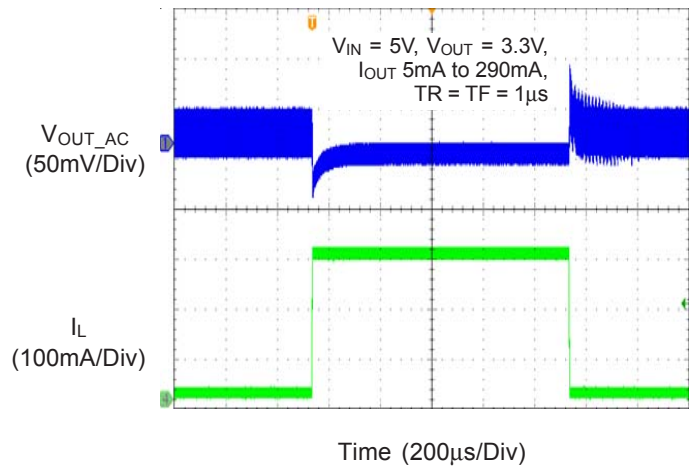

Load Transient Response

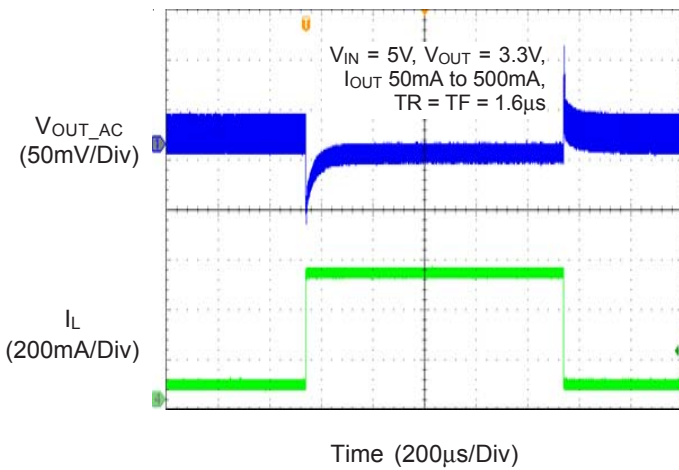

Load Transient Response

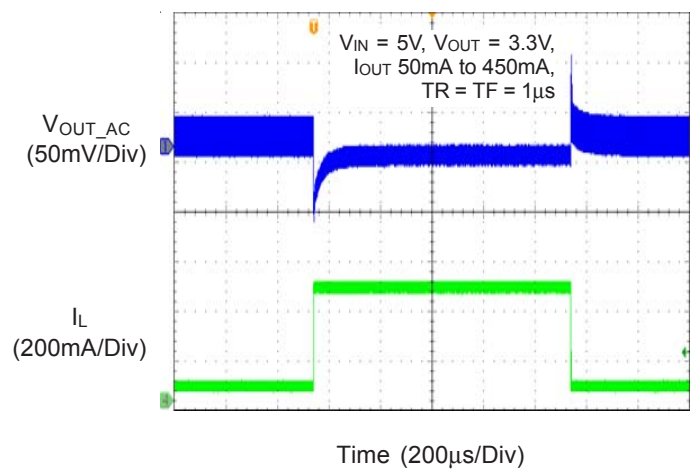

100% Duty Cycle Entry and Leave Operation

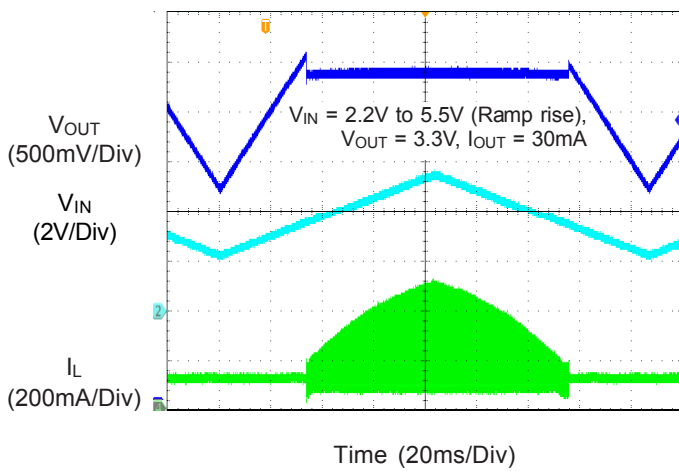

Application Information

The RT5707/A is a synchronous low voltage step-down converter that can support the input voltage range from 2.2V to 5.5V and the output current can be up to 600mA, peak to 1A (RT5707) / 400mA, peak to 0.5A (RT5707A). Internal compensation are integrated to minimize external component count. Protection features include over-current protection, under-voltage protection and over-temperature protection.

Inductor Selection

The recommended power inductor is 2.2μH and inductor saturation current rating choose follow over current protection design consideration. In applications, it needs to select an inductor with the low DCR to provide good performance and efficiency.

C_{IN} and C_{OUT} Selection

The input capacitance, C_{IN}, is needed to filter the trapezoidal current at the source of the top MOSFET. To prevent large ripple voltage, a low ESR input capacitor sized for the maximum RMS current should be used. RMS current is given by :

$$I_{RMS} = I_{OUT(MAX)} \times \frac{V_{OUT}}{V_{IN}} \times \sqrt{\frac{V_{IN}}{V_{OUT}} - 1}$$

This formula has a maximum at V_{IN} = 2V_{OUT}, where I_{RMS} = I_{OUT} / 2. This simple worst-case condition is commonly used for design because even significant deviations do not offer much relief. To choose a capacitor rated at a higher temperature than required.

Several capacitors may also be paralleled to meet size or height requirements in the design.

The selection of C_{OUT} is determined by the Effective Series Resistance (ESR) that is required to minimize voltage ripple and load step transients, as well as the amount of bulk capacitance that is necessary to ensure that the control loop is stable. Loop stability can be checked by viewing the load transient response as described in a later section.

The output ripple, ΔV_{OUT}, is determined by :

$$\Delta V_{OUT} \leq \Delta I_L \left[ESR + \frac{1}{8 \times f_{SW} \times C_{OUT}} \right]$$

Thermal Considerations

The junction temperature should never exceed the absolute maximum junction temperature T_{J(MAX)}, listed under Absolute Maximum Ratings, to avoid permanent damage to the device. The maximum allowable power dissipation depends on the thermal resistance of the IC package, the PCB layout, the rate of surrounding airflow, and the difference between the junction and ambient temperatures. The maximum power dissipation can be calculated using the following formula :

$$P_{D(MAX)} = (T_{J(MAX)} - T_A) / \theta_{JA}$$

where T_{J(MAX)} is the maximum junction temperature, T_A is the ambient temperature, and θ_{JA} is the junction-to-ambient thermal resistance.

For continuous operation, the maximum operating junction temperature indicated under Recommended Operating Conditions is 125°C. The junction-to-ambient thermal resistance, θ_{JA}, is highly package dependent. For a WL-CSP-8B 0.9x1.6 (BSC) package, the thermal resistance, θ_{JA}, is 118.5°C/W on a standard JEDEC 51-7 high effective-thermal-conductivity four-layer test board. The maximum power dissipation at T_A = 25°C can be calculated as below
 $P_{D(MAX)} = (125^\circ\text{C} - 25^\circ\text{C}) / (118.5^\circ\text{C}/\text{W}) = 0.84\text{W}$ for a WL-CSP-8B 0.9x1.6 (BSC) package.

The maximum power dissipation depends on the operating ambient temperature for the fixed T_{J(MAX)} and the thermal resistance, θ_{JA}. The derating curves in Figure 2 allows the designer to see the effect of rising ambient temperature on the maximum power dissipation.

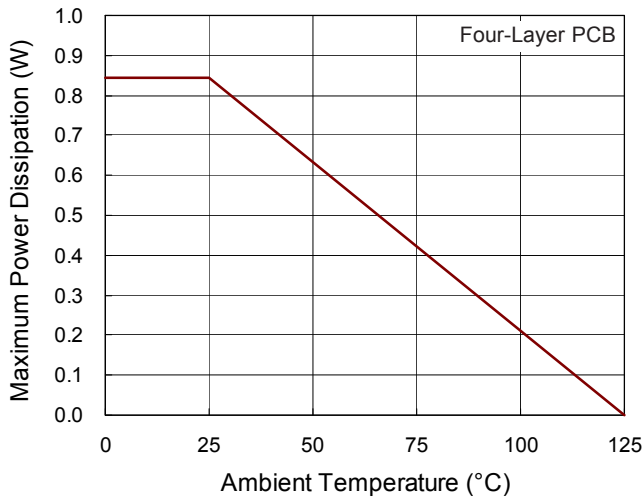

Figure 2. Derating Curve of Maximum Power Dissipation

Layout Considerations

For high frequency switching power supplies, the PCB layout is important to get good regulation, high efficiency and stability. The following descriptions are the guidelines for better PCB layout.

- ▶ For good regulation, place the power components as close as possible. The traces should be wide and short enough especially for the high-current loop.
- ▶ Shorten the SW node trace length and make it wide.

Table 2. Protection Trigger Condition and Behavior

Protection Type		Threshold Refer to Electrical Spec.	Protection Method	Reset Method
RT5707	UGATE Current Limit	$I_{SW} > 1.2A$ (Typ.)	Turn off UG MOS	$I_{SW} < 1.2A$ (Typ.)
	LGATE Current Limit	$I_{SW} > 1.2A$ (Typ.)	Turn on LG MOS	$I_{SW} < 1.2A$ (Typ.)
RT5707A	UGATE Current Limit	$I_{SW} > 0.78A$ (Typ.)	Turn off UG MOS	$I_{SW} < 0.78A$ (Typ.)
	LGATE Current Limit	$I_{SW} > 0.68A$ (Typ.)	Turn on LG MOS	$I_{SW} < 0.68A$ (Typ.)
UVLO		$V_{UVLOF} < 1.9V$ (Typ.)	Shutdown	$V_{UVLOR} > 2V$ (Typ.)
OTP		Temperature $> 150^{\circ}C$ (Typ.)	Shutdown	Temperature $< 130^{\circ}C$ (Typ.)

TOP View

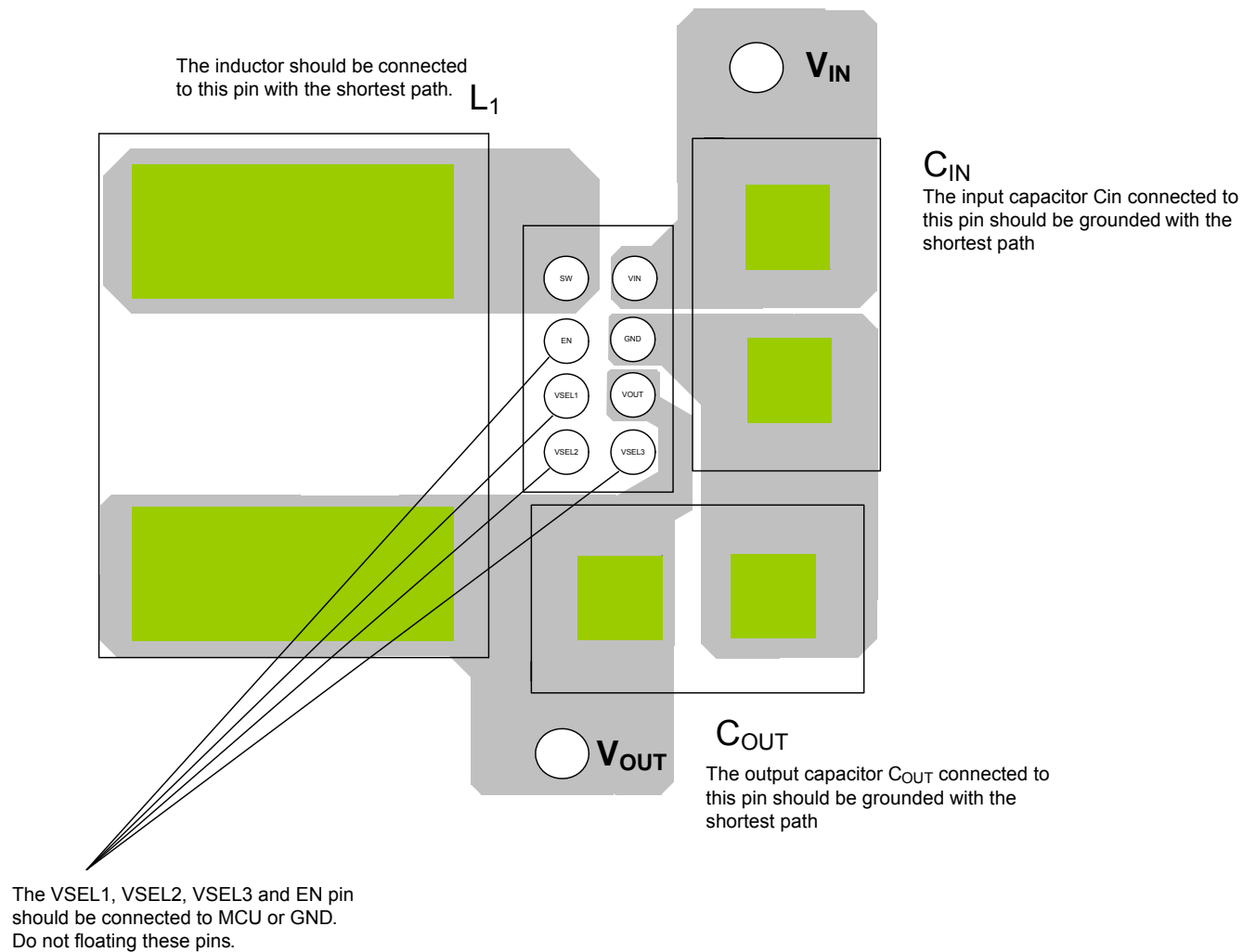

Figure 3. RT5707 PCB Layout Guide

TOP View

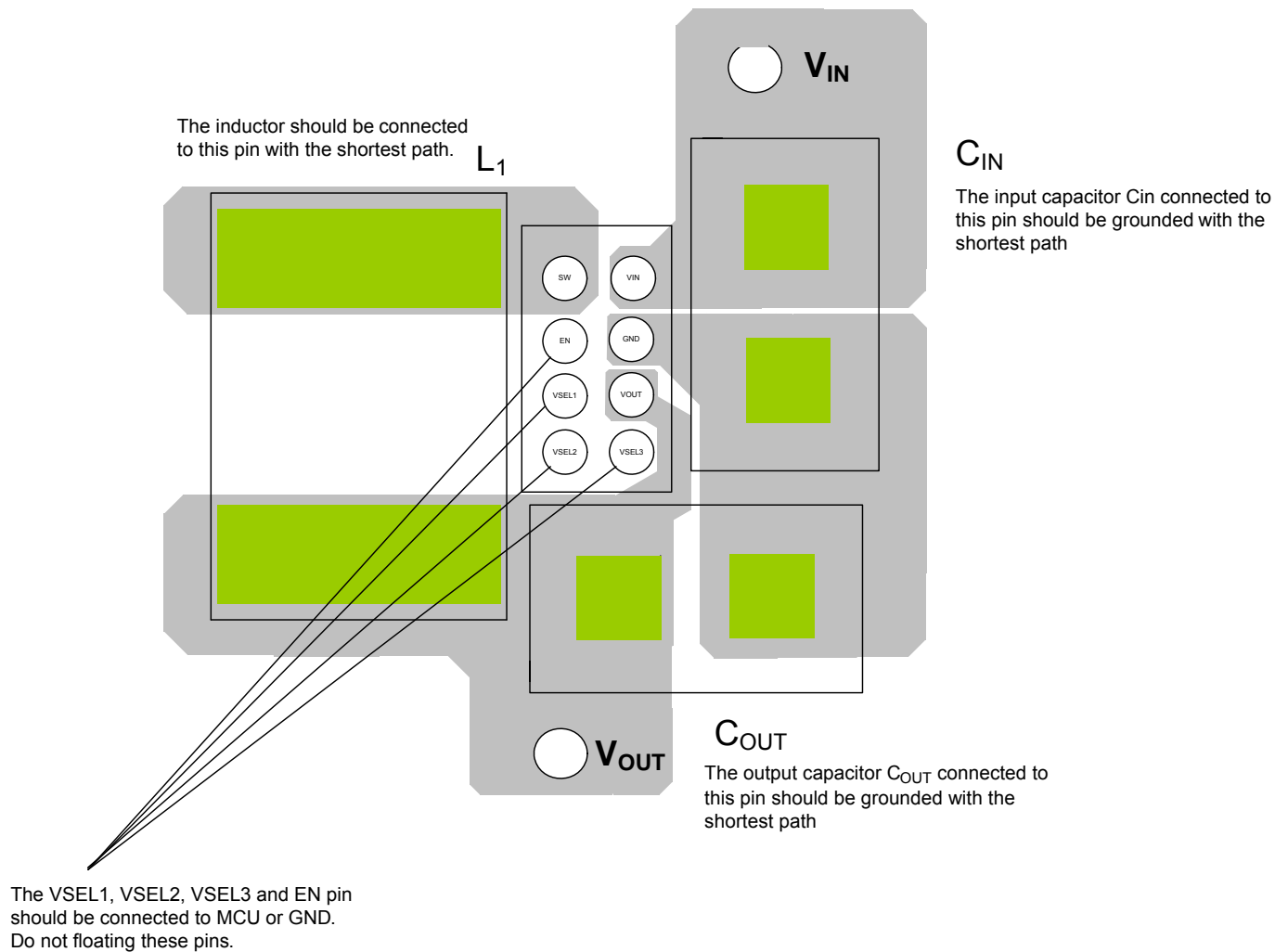
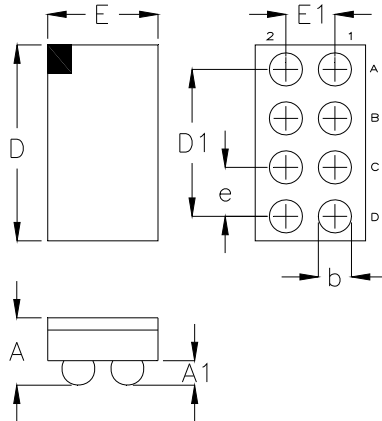

Figure 4. RT5707A PCB Layout Guide

Outline Dimension



Symbol	Dimensions In Millimeters		Dimensions In Inches	
	Min	Max	Min	Max
A	0.500	0.600	0.020	0.024
A1	0.170	0.230	0.007	0.009
b	0.240	0.300	0.009	0.012
D	1.560	1.640	0.061	0.065
D1	1.200		0.047	
E	0.860	0.940	0.034	0.037
E1	0.400		0.016	
e	0.400		0.016	

8B WL-CSP 0.9x1.6 Package (BSC)

Footprint Information

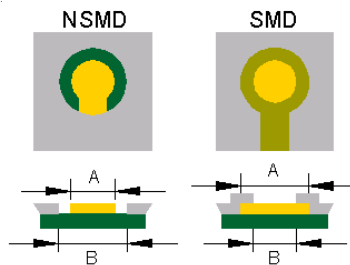
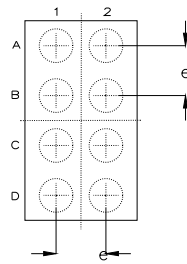

Package	Number of Pin	Type	Footprint Dimension (mm)			Tolerance
			e	A	B	
WL-CSP0.9x1.6-8(BSC)	8	NSMD	0.400	0.240	0.340	±0.025
		SMD		0.270	0.240	

Richtek Technology Corporation

14F, No. 8, Tai Yuen 1st Street, Chupei City
 Hsinchu, Taiwan, R.O.C.
 Tel: (8863)5526789

Richtek products are sold by description only. Richtek reserves the right to change the circuitry and/or specifications without notice at any time. Customers should obtain the latest relevant information and data sheets before placing orders and should verify that such information is current and complete. Richtek cannot assume responsibility for use of any circuitry other than circuitry entirely embodied in a Richtek product. Information furnished by Richtek is believed to be accurate and reliable. However, no responsibility is assumed by Richtek or its subsidiaries for its use; nor for any infringements of patents or other rights of third parties which may result from its use. No license is granted by implication or otherwise under any patent or patent rights of Richtek or its subsidiaries.

X-ON Electronics

Largest Supplier of Electrical and Electronic Components

Click to view similar products for [Isolated DC/DC Converters](#) category:

Click to view products by [Richtek](#) manufacturer:

Other Similar products are found below :

[ESM6D044440C05AAQ](#) [FMD15.24G](#) [PSL486-7LR](#) [PSR152.5-7IR](#) [Q48T30020-NBB0](#) [AVO240-48S12B-6L](#) [AVO250-48S28B-6L](#) [NAN-0505](#) [HW-L16D](#) [JAHW100Y1](#) [217-1617-001](#) [22827](#) [SPB05C-12](#) [SQ24S15033-PS0S](#) [18952](#) [19-130041](#) [CE-1003](#) [CE-1004](#) [GQ2541-7R](#) [PSE1000DCDC-12V](#) [RDS180245](#) [MAU228](#) [419-2065-201](#) [449-2075-101](#) [TME 0303S](#) [TME 0505S](#) [TME 1205S](#) [TME 1212S](#) [TME 2405S](#) [TME 2412S](#) [V300C24C150BG](#) [419-2062-200](#) [419-2063-401](#) [419-2067-101](#) [419-2067-501](#) [419-2068-001](#) [DCG40-5G](#) [DFC15U48D15](#) [449-2067-000](#) [XGS-0512](#) [XGS-1205](#) [XGS-1212](#) [XGS-2412](#) [XGS-2415](#) [XKS-1215](#) [033456](#) [NCT1000N040R050B](#) [SPB05B-15](#) [SPB05C-15](#) [TME 0509S](#)