

1A, Low Noise, High PSRR, Low-Dropout Linear Regulator

1 General Description

The RTQ2510 is a high performance positive low dropout (LDO) regulator designed for applications requiring very low dropout voltage and high Power Supply Ripple Rejection (PSRR) at up to 1A. The input voltage range is from 2.2V to 6V and the output voltage is programmable as low as 0.8V. The P-MOSFET switch provides excellent transient response with only a 4.7µF ceramic output capacitor. The external enable control effectively reduces power dissipation while shutdown and further output noise immunity is achieved through bypass capacitor on NR pin. Additionally, the RTQ2510 features a precise 3% output regulation over line, load, and temperature variations. The device is available in the VDFN-8L 3x3 package and is specified from -40°C to 125°C.

2 Ordering Information

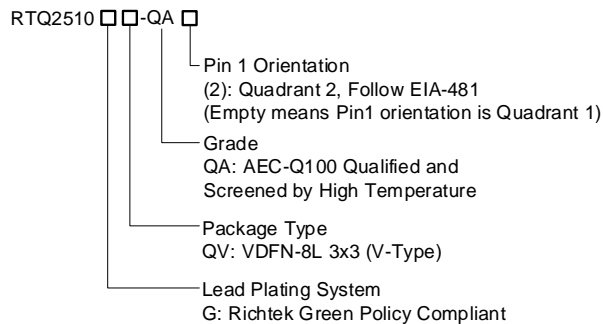

Note:

Richtek products are Richtek Green Policy compliant and compatible with the current requirements of IPC/JEDEC J-STD-020

3 Marking Information

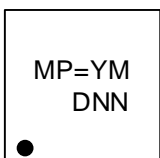

MP= : Product Code
YMDNN : Date Code

4 Features

- AEC-Q100 Grade 1 Qualified
- Dropout: 170mV Typical at 1A
- High PSRR: 63dB @ 1kHz, 38dB @ 1MHz
- Input Voltage Range: 2.2V to 6V
- Adjustable Output Voltage: 0.8V to 5.5V
- -40°C to 125°C Operating Junction Temperature Range
- Noise Immunity
- Fast Response Over Load and Line Transient
- Stable with a 4.7µF Output Ceramic Capacitor
- Accurate Output Voltage 3% Over Load, Line, Process, and Temperature Variations
- Enable Control
- Over-Current Protection
- Over-Temperature Protection

5 Applications

- Telecom/Networking Cards
- Motherboards/Peripheral Cards
- Industrial Applications
- Wireless Infrastructures
- Set-Top Boxes
- Medical Equipments
- Notebook Computers
- Battery Powered Systems
- Automotive Applications: Camera, Radar, Sensors

6 Pin Configuration

(TOP VIEW)

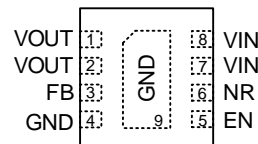

VDFN-8L 3x3

Table of Contents

1	General Description -----	1
2	Ordering Information -----	1
3	Marking Information -----	1
4	Features -----	1
5	Applications -----	1
6	Pin Configuration -----	1
7	Functional Pin Description -----	3
8	Functional Block Diagram -----	4
9	Absolute Maximum Ratings -----	5
10	ESD Ratings -----	5
11	Recommended Operating Conditions -----	5
12	Thermal Information -----	5
13	Electrical Characteristics -----	6
14	Typical Application Circuit -----	8
15	Typical Operating Characteristics -----	9
16	Operation -----	11
	16.1 Start-Up -----	11
	16.2 Enable and Shutdown Operation -----	11
	16.3 Current Limit -----	11
	16.4 Over-Temperature Protection (OTP) -----	11
	16.5 Under Voltage Lock-Out (UVLO)-----	12
17	Application Information -----	13
	17.1 Dropout Voltage -----	13
	17.2 Output Voltage Setting-----	13
	17.3 Chip Enable Operation -----	13
	17.4 Current Limit -----	13
	17.5 C _{IN} and C _{OUT} Selection -----	13
	17.6 Output Noise -----	14
	17.7 Thermal Considerations -----	14
	17.8 Layout Considerations -----	15
18	Outline Dimension -----	16
19	Footprint Information -----	17
20	Packing Information -----	18
	20.1 Tape and Reel Data -----	18
	20.2 Tape and Reel Packing-----	19
	20.3 Packing Material Anti-ESD Property-----	20
21	Datasheet Revision History -----	21

7 Functional Pin Description

Pin No.	Pin Name	Pin Function
1, 2	VOUT	Output of the regulator. Decouple this pin to GND with at least 4.7 μ F for stability.
3	FB	Feedback voltage input. This pin is used to set the desired output voltage via an external resistive divider. The feedback reference voltage is 0.8V typically.
4, 9 (Exposed Pad)	GND	System ground. The exposed pad must be soldered to a large PCB and connected to GND for maximum power dissipation.
5	EN	Enable control input. Connecting this pin to logic high enables the regulator or driving this pin low puts it into shutdown mode. EN can be connected to IN if not used. (EN pin is not allowed to be left floating.)
6	NR	Noise reduction input. Decouple this pin to GND with an external capacitor can not only reduce output noise to very low levels but also slow down the VOUT rise like a soft-start behavior.
7, 8	VIN	Supply input. A minimum of 1 μ F ceramic capacitor should be placed as close as possible to this pin for better noise rejection.

8 Functional Block Diagram

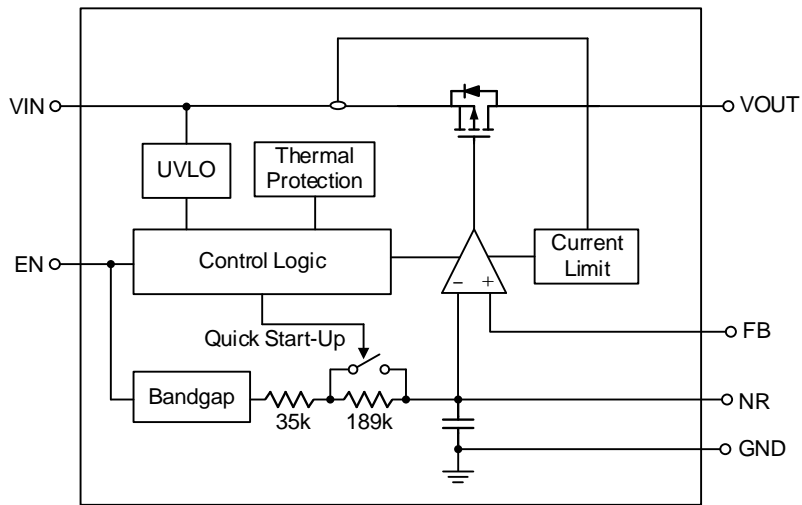

9 Absolute Maximum Ratings

(Note 1)

- All Pins ----- -0.3V to 7V
- Lead Temperature (Soldering, 10 sec.) ----- 260°C
- Junction Temperature ----- 150°C
- Storage Temperature Range ----- -65°C to 150°C

10 ESD Ratings

(Note 2)

- ESD Susceptibility
- HBM (Human Body Model)----- 2kV

11 Recommended Operating Conditions

(Note 3)

- Supply Input Voltage, VIN ----- 2.2V to 6V
- Junction Temperature Range----- -40°C to 125°C

12 Thermal Information

(Note 4 and Note 5)

Thermal Parameter		VDFN-8L 3x3	Unit
θ_{JA}	Junction-to-ambient thermal resistance (JEDEC standard)	60.82	°C/W
$\theta_{JC(Top)}$	Junction-to-case (top) thermal resistance	83.76	°C/W
$\theta_{JC(Bottom)}$	Junction-to-case (bottom) thermal resistance	10.48	°C/W
$\theta_{JA(EVB)}$	Junction-to-ambient thermal resistance (specific EVB)	45.06	°C/W
$\Psi_{JC(Top)}$	Junction-to-top characterization parameter	5.42	°C/W
Ψ_{JB}	Junction-to-board characterization parameter	26.17	°C/W

13 Electrical Characteristics

($V_{IN} = V_{OUT} + 0.5V$ or $2.2V$, $V_{OUT} = 0.8V$ and $5.5V$, $I_{OUT} = 1mA$, $V_{EN} = 2.2V$, $C_{NR} = 10nF$, $C_{OUT} = 4.7\mu F$, $T_J = -40^{\circ}C$ to $125^{\circ}C$, unless otherwise specified)

Parameter	Symbol	Test Conditions	Min	Typ	Max	Unit	
Supply Voltage							
VIN Supply Input Voltage	VIN		2.2	--	6	V	
Undervoltage Lockout Rising Threshold	VUVLO_R	ROUT = 1kΩ	1.86	2	2.1		
Undervoltage Lockout Hysteresis	VUVLO_HYS	ROUT = 1kΩ	--	200	--	mV	
Shutdown Current	ISHDN	VEN ≤ 0.4V, VIN ≥ 2.2V, ROUT = 1kΩ, 0°C ≤ TJ ≤ 85°C	--	0.2	2	μA	
		VEN ≤ 0.4V, VIN ≥ 2.2V, ROUT = 1kΩ, -40°C ≤ TJ ≤ 125°C	--	0.2	5		
Quiescent Current	IQ		--	190	350	μA	
Output Voltage							
Output Voltage	VOUT		0.8	--	5.5	V	
Output Supply Voltage Accuracy (Note 6)	VOUT_ACC	VOUT + 0.5V ≤ VIN ≤ 6V, VIN ≥ 2.5V, 100mA ≤ IOUT ≤ 500mA, 0°C ≤ TJ ≤ 85°C	-2	--	+2	%	
		VOUT + 0.5V ≤ VIN ≤ 6V, VIN ≥ 2.2V, 100mA ≤ IOUT ≤ 1A	-3	±0.3	+3		
Line Regulation	VLINE_REG	VOUT + 0.5V ≤ VIN ≤ 6V, VIN ≥ 2.2V, IOUT = 100mA	--	0.2	--	%	
Load Regulation	VLOAD_REG	100mA ≤ IOUT ≤ 1A	--	0.3	--	%	
Enable Voltage							
EN Input Voltage Rising Threshold	VEN_R	VEN rising	2.2V ≤ VIN ≤ 6V, ROUT = 1kΩ	1.2	--	--	V
EN Input Voltage Falling Threshold	VEN_F	VEN falling, ROUT = 1kΩ		--	--	0.4	
Enable Input Current	IEN	VIN = 6V, VEN = 6V	--	0.02	1	μA	
FB Pin Current	IFB	VIN = 5.5V, VFB = 0.8V	--	0.02	1	μA	
Current Limit							
Current Limit	ILIM	VIN = 3.3V, VOUT = 0.85 x VOUT	1.1	1.4	2	A	
Power-Up Time							
Power-Up Time		VOUT = 3.3V, ROUT = 3.3kΩ, COUT = 4.7μF	CNR = 1nF	--	0.16	--	ms
			CNR = 10nF	--	1.6	--	

Dropout Voltage							
Dropout Voltage	V _{DROP}	$V_{OUT} + 0.5V \leq V_{IN} \leq 6V,$ $V_{FB} = 0V$	$V_{IN} \geq 2.2V,$ $I_{OUT} = 500mA$	--	--	160	mV
			$V_{IN} \geq 2.5V,$ $I_{OUT} = 750mA$	--	--	210	
			$V_{IN} \geq 2.5V,$ $I_{OUT} = 1A$	--	--	370	
Power Supply Ripple Rejection and Noise							
Power Supply Ripple Rejection	PSRR	$V_{IN} = 4.3V, V_{OUT} = 3.3V,$ $I_{OUT} = 750mA$ (Note 7)	f = 100Hz	--	48	--	dB
			f = 1kHz	--	63	--	
			f = 10kHz	--	63	--	
			f = 1MHz	--	38	--	
Output Noise	V _n	BW = 100Hz to 100kHz, $V_{IN} = 4.3V, V_{OUT} = 3.3V,$ $I_{OUT} = 100mA$ (Note 7)	CNR = 1nF	--	15.6 x V _{OUT}	--	μV _{RMS}
			CNR = 10nF	--	15.6 x V _{OUT}	--	
			CNR = 0.1μF	--	15.1 x V _{OUT}	--	
Over-Temperature Protection							
Over-Temperature Protection Threshold	T _{OTP}	(Note 7)		--	160	--	°C
Over-Temperature Protection Hysteresis	T _{OTP_HYS}	(Note 7)		--	20	--	

Note 1. Stresses beyond those listed under “Absolute Maximum Ratings” may cause permanent damage to the device. These are stress ratings only, and functional operation of the device at these or any other conditions beyond those indicated in the operational sections of the specifications is not implied. Exposure to absolute maximum rating conditions may affect device reliability.

Note 2. Devices are ESD sensitive. Handling precautions are recommended.

Note 3. The device is not guaranteed to function outside its operating conditions.

Note 4. For more information about thermal parameter, see the Application and Definition of Thermal Resistances report, [AN061](#).

Note 5. θ_{JA} (EVB), Ψ_{JC(Top)} and Ψ_{JB} are measured on a high effective-thermal-conductivity four-layer test board which is in size of 70mm x 50mm; furthermore, all layers with 1 oz. Cu. Thermal resistance/parameter values may vary depending on the PCB material, layout, and test environmental conditions.

Note 6. The spec doesn't cover the tolerances from external resistors, and which is not tested at condition of V_{OUT} = 0.8V, 4.5V ≤ V_{IN} ≤ 6V, and 750mA ≤ I_{OUT} ≤ 1A since the power dissipation of the device is totally higher than the maximum rating of the package to lead a thermal shutdown issue.

Note 7. Guarantee by design.

14 Typical Application Circuit

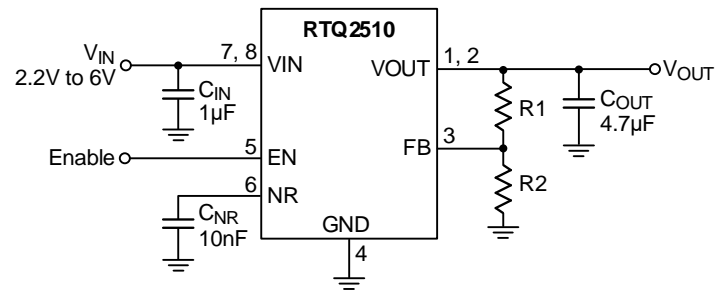

15 Typical Operating Characteristics

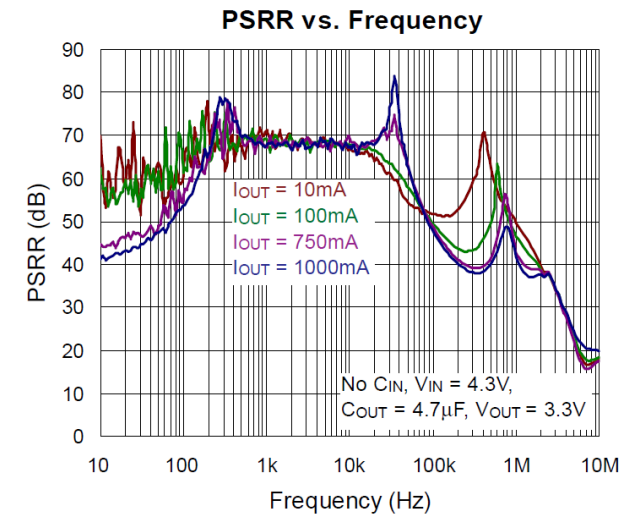
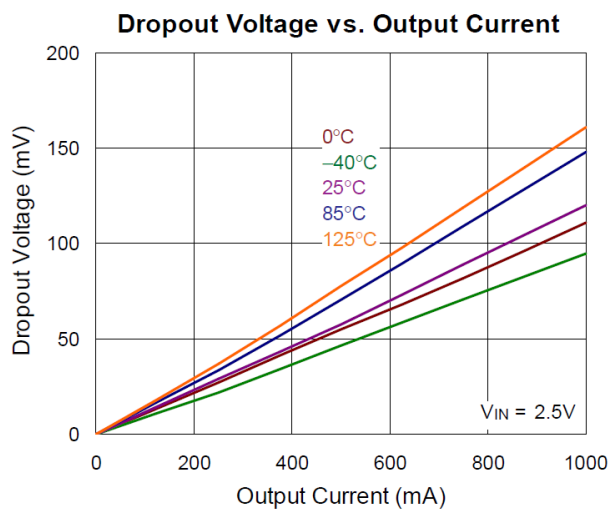
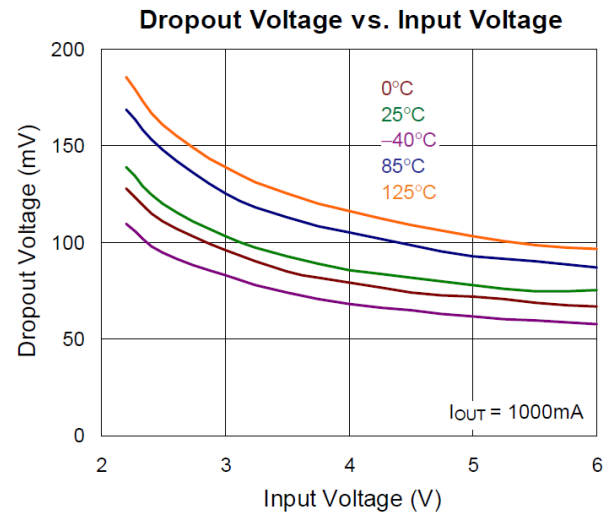
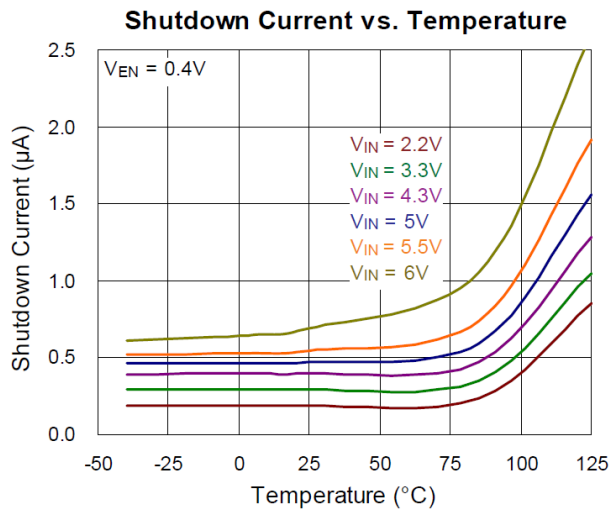
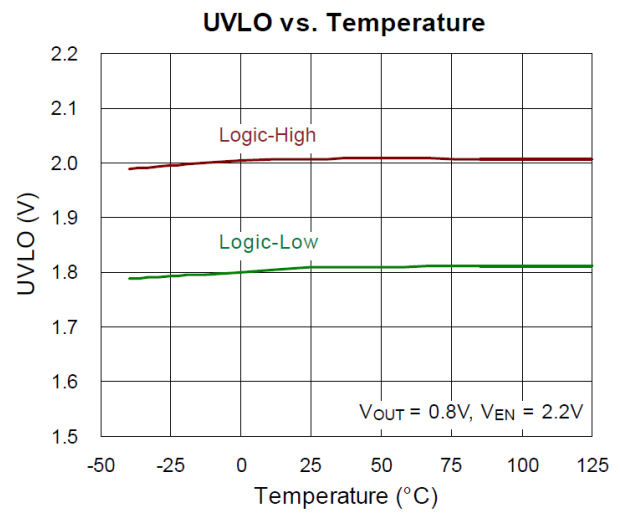
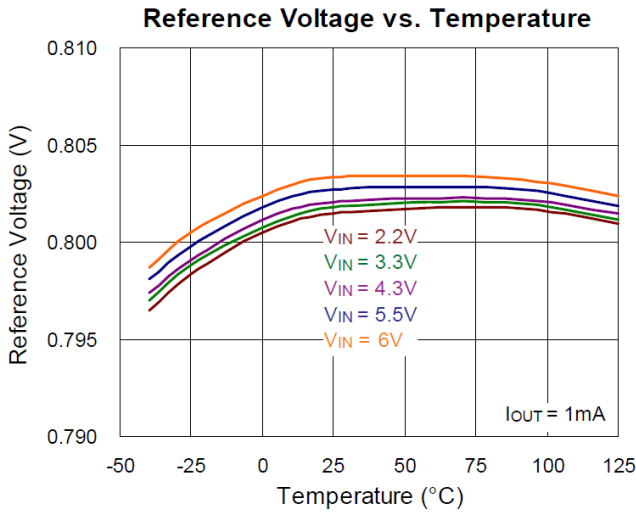

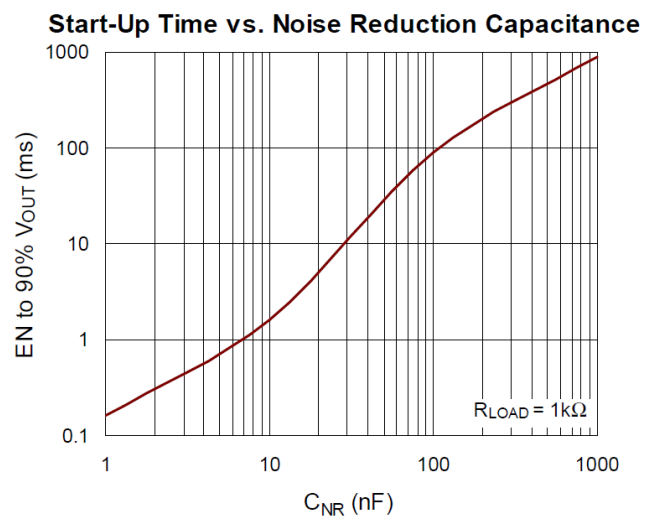
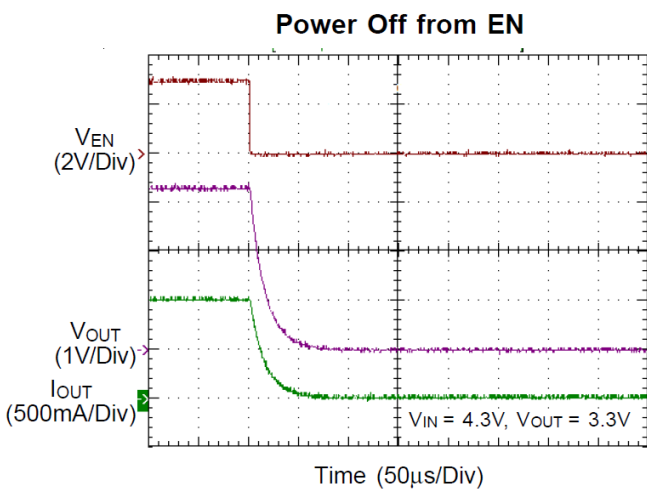
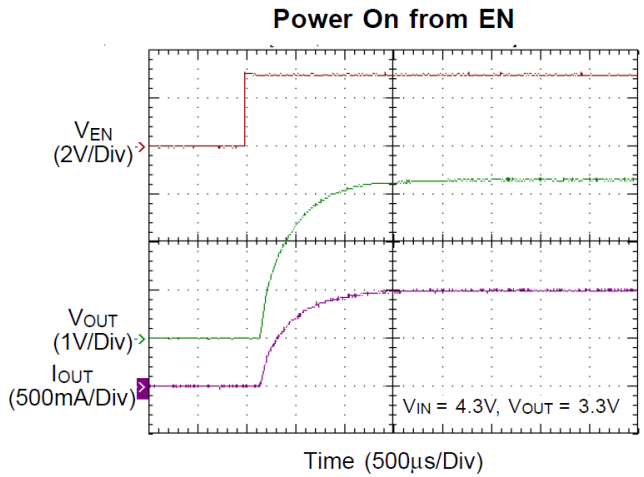
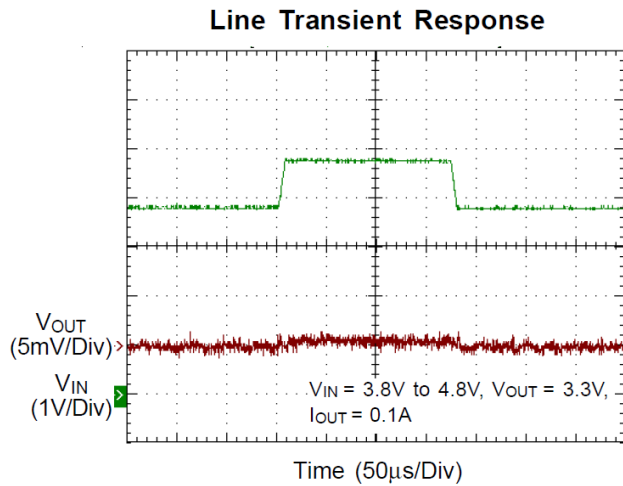
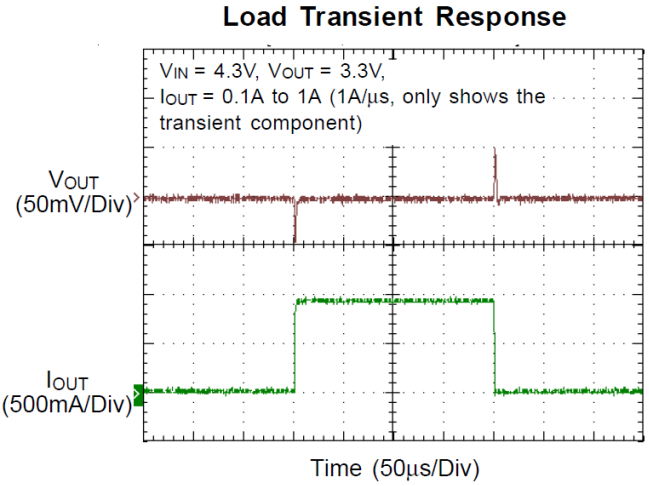
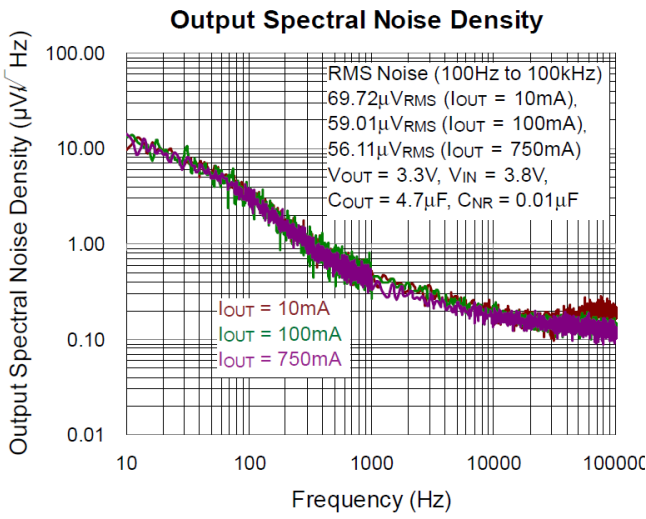

16 Operation

The RTQ2510 is a low noise, high PSRR LDO which supports very low dropout operation. The operating input range from 2.2V to 6V, the output voltage is programmable as low to 0.8V and the output current can be up to 1A. The internal compensation network is well designed to achieve fast transient response with good stability.

In steady-state operation, the feedback voltage is regulated to the reference voltage by the internal regulator. When the feedback voltage signal is less than the reference, the output current passes through the power MOSFET will be increased. The extra amount of the current is sent to the output until the voltage level of FB pin returns to the reference.

On the other hand, if the feedback voltage is higher than the reference, the power MOSFET current is decreased. The excess charge at the output can be released by the loading current.

16.1 Start-Up

The RTQ2510 has a quick-start circuit to charge the noise reduction capacitor (C_{NR}). The switch of the quick-start circuit is closed at start up.

To reduce the noise from bandgap, there is a low-pass (RC) filter consist of the C_{NR} and the resistance, which is connected with bandgap, as Functional Block Diagrams present.

At the start-up, the quick-start switch is closed, with only 35kΩ resistance between bandgap and NR pin. The quick-start switch opens approximate 2ms after the device is enabled, and the resistance between NR and bandgap is about 224kΩ to form a very good low pass filter and with great noise reduction performance.

The 35kΩ resistance is used to slow down the reference voltage ramp to avoid inrush current at chip start-up, and the start-up time can be calculated as :

$$t_{SS} \text{ (sec)} = 160000 \times C_{NR} \text{ (F)} \tag{1}$$

It is recommended the C_{NR} value is larger than 0.01μF to reduce noise, and low leakage ceramic capacitors are suitable. However, with too large C_{NR} will extend the start-up time very long if the C_{NR} is not fully charged during 2ms and opens the quick-start switch. The C_{NR} will be charged through higher resistance 224kΩ and takes much longer time to finish the start up process.

16.2 Enable and Shutdown Operation

The RTQ2510 goes into sleep mode when the EN pin is in a logic low condition. In this condition, the pass transistor, error amplifier, and bandgap are all turned off, reducing the supply current to only 2μA (max.). If the shutdown mode is not required, the EN pin can be directly tied to VIN pin to keep the LDO on.

16.3 Current Limit

The RTQ2510 continuously monitors the output current to protect the pass transistor against abnormal operations. When an overload or short circuit is encountered, the current limit circuitry controls the pass transistor's gate voltage to limit the output within the predefined range. By reason of the build-in body diode, the pass transistor conducts current when the output voltage exceeds input voltage. Since the current is not limited, external current protection should be added if device may work at reverse voltage state.

16.4 Over-Temperature Protection (OTP)

The RTQ2510 has an over-temperature protection. When the device triggers the OTP, the device shuts down until the temperature back to normal state.

16.5 Under Voltage Lock-Out (UVLO)

The RTQ2510 utilizes an under-voltage lockout circuit to keep the output shutdown until the internal circuitry is operating properly. The UVLO circuit has a de-glitch feature so that it typically ignores undershoot transients on the input if they are less than 30 μ s duration.

17 Application Information

Richtek's component specification does not include the following information in the Application Information section. Thereby no warranty is given regarding its validity and accuracy. Customers should take responsibility to verify their own designs and reserve suitable design margin to ensure the functional suitability of their components and systems.

The RTQ2510 is a low voltage, low dropout linear regulator with input voltage from 2.2V to 6V and a fixed output voltage from 0.8V to 5.5V.

17.1 Dropout Voltage

The dropout voltage refers to the voltage difference between the VIN and VOUT pins while operating at specific output current. The dropout voltage VDO also can be expressed as the voltage drop on the pass-FET at specific output current (IRATED) while the pass-FET is fully operating at ohmic region, and the pass-FET can be characterized as an resistance RDS(ON). Thus, the dropout voltage can be defined as ($V_{DROP} = V_{IN} - V_{OUT} = R_{DS(ON)} \times I_{RATED}$).

For normal operation, the suggested LDO operating range is ($V_{IN} > V_{OUT} + V_{DROP}$) for good transient response and PSRR ability. Vice versa, while operating at the ohmic region will degrade these performance severely.

17.2 Output Voltage Setting

For the RTQ2510, the voltage on the FB pin sets the output voltage and is determined by the values of R1 and R2. The values of R1 and R2 can be calculated for any voltage using the formula given in the equation below :

$$V_{OUT} = \frac{(R1 + R2)}{R2} \times 0.8$$

17.3 Chip Enable Operation

The EN pin is the chip enable input. Pull the EN pin low (<0.4V) will shut down the device. During shutdown mode, the RTQ2510 quiescent current drops to lower than 2μA. Drive the EN pin to high (>1.2V, <6V) will turn on the device again. For external timing control (e.g.RC), the EN pin can also be externally pulled to High by adding a 100kΩ or greater resistor from the VIN pin.

17.4 Current Limit

The RTQ2510 continuously monitors the output current to protect the pass transistor against abnormal operations. When an overload or short circuit is encountered, the current limit circuitry controls the pass transistor's gate voltage to limit the output within the predefined range. By reason of the build-in body diode, the pass transistor conducts current when the output voltage exceeds input voltage. Since the current is not limited, external current protection should be added if device may work at reverse voltage state.

17.5 CIN and COUT Selection

Like any low dropout regulator, the external capacitors of the RTQ2510 must be carefully selected for regulator stability and performance. Using a capacitor of at least 4.7μF is suitable. The input capacitor must be located at a distance of no more than 0.5 inch from the input pin of the chip. Any good quality ceramic capacitor can be used. However, a capacitor with larger value and lower ESR (Equivalent Series Resistance) is recommended since it will provide better PSRR and line transient response.

The RTQ2510 is designed specifically to work with low ESR ceramic output capacitor for space saving and

performance consideration. Using a ceramic capacitor with capacitance of at least 4.7μF on the RTQ2510 output ensures stability.

17.6 Output Noise

Generally speaking, the dominant noise source is from the internal bandgap for most LDOs. With the noise reduction capacitor connecting to the NR pin of the RTQ2510, the noise component contributed from bandgap will not be significantly. Instead, the most noise source comes from the output resistor divider and the error amplifier input. For general application to minimize noise, using a 0.01μF noise-reduction capacitor (CNR) is recommended.

17.7 Thermal Considerations

Thermal protection limits power dissipation in the RTQ2510. When the operation junction temperature exceeds 160°C, the OTP circuit starts the thermal shutdown function and turns the pass element off. The pass element turns on again after the junction temperature cools down by 20°C.

The RTQ2510 output voltage will be closed to zero when output short circuit occurs as shown in Figure 1. It can reduce the chip temperature and provides maximum safety to end users when output short circuit occurs.

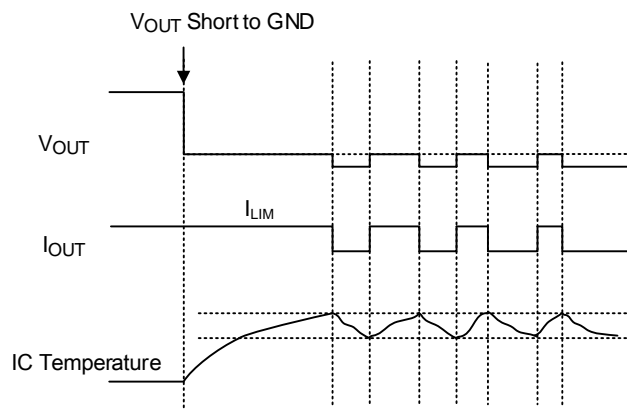

Figure 1. Short-Circuit Protection when Output Short-Circuit Occurs

The junction temperature should never exceed the absolute maximum junction temperature $T_{J(MAX)}$, listed under Absolute Maximum Ratings, to avoid permanent damage to the device. The maximum allowable power dissipation depends on the thermal resistance of the IC package, the PCB layout, the rate of surrounding airflow, and the difference between the junction and ambient temperatures. The maximum power dissipation can be calculated using the following formula :

$$P_{D(MAX)} = (T_{J(MAX)} - T_A) / \theta_{JA}$$

where $T_{J(MAX)}$ is the maximum junction temperature, T_A is the ambient temperature, and θ_{JA} is the junction-to-ambient thermal resistance.

For continuous operation, the maximum operating junction temperature indicated under Recommended Operating Conditions is 125°C. The junction-to-ambient thermal resistance, θ_{JA} , is highly package dependent. For a VDFN-8L 3x3 package, the thermal resistance, θ_{JA} , is 45.06°C/W on a standard JEDEC 51-7 high effective-thermal-conductivity four-layer test board. The maximum power dissipation at $T_A = 25^\circ\text{C}$ can be calculated as below :

$$P_{D(MAX)} = (125^\circ\text{C} - 25^\circ\text{C}) / (45.06^\circ\text{C/W}) = 2.22\text{W for a VDFN-8L 3x3 package.}$$

The maximum power dissipation depends on the operating ambient temperature for the fixed $T_{J(MAX)}$ and the thermal resistance, θ_{JA} . The derating curves in Figure 2 allows the designer to see the effect of rising ambient temperature on the maximum power dissipation.

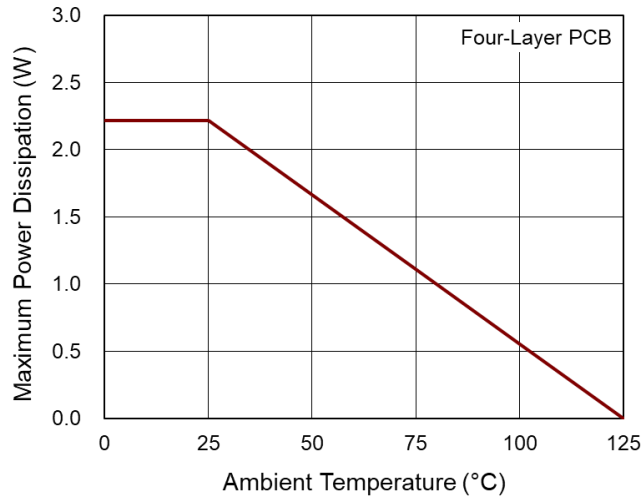

Figure 2. Derating Curve of Maximum Power Dissipation

17.8 Layout Considerations

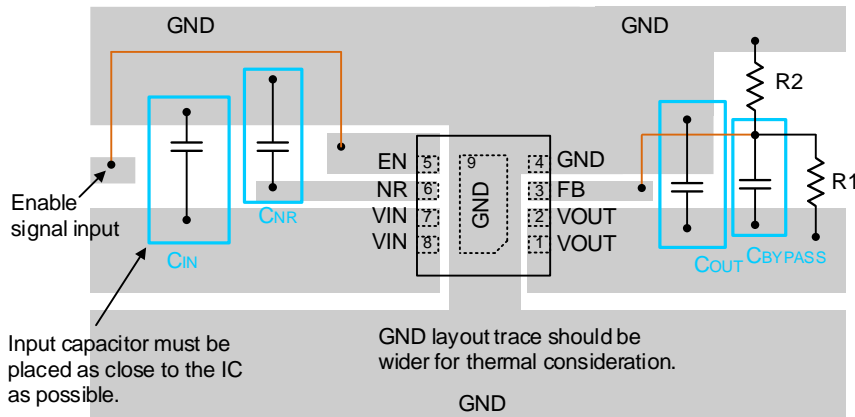
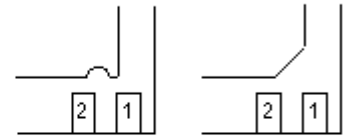
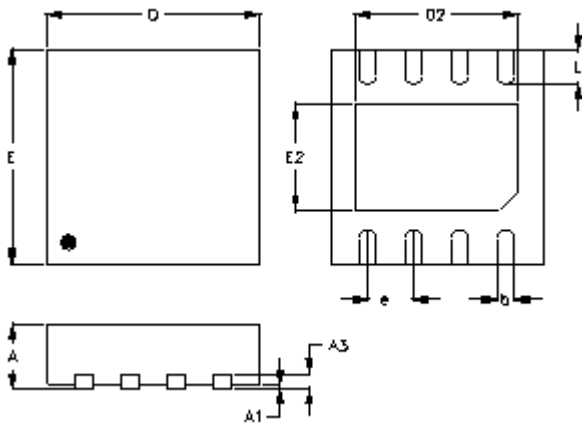

Figure 3. PCB Layout Guide

18 Outline Dimension



DETAIL A

Pin #1 ID and Tie Bar Mark Options

Note : The configuration of the Pin #1 identifier is optional, but must be located within the zone indicated.

Symbol	Dimensions In Millimeters		Dimensions In Inches	
	Min	Max	Min	Max
A	0.700	0.900	0.027	0.035
A1	0.000	0.050	0.000	0.002
A3	0.175	0.250	0.007	0.010
b	0.200	0.300	0.008	0.012
D	2.950	3.050	0.116	0.120
D2	2.100	2.350	0.083	0.093
E	2.950	3.050	0.116	0.120
E2	1.350	1.600	0.053	0.063
e	0.650		0.026	
L	0.425	0.525	0.017	0.021

V-Type 8L DFN 3x3 Package

19 Footprint Information

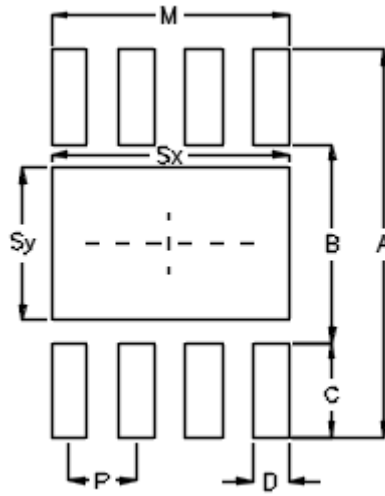

Package	Number of Pin	Footprint Dimension (mm)								Tolerance
		P	A	B	C	D	Sx	Sy	M	
V/W/U/XDFN3*3-8	8	0.65	3.80	1.94	0.93	0.35	2.30	1.50	2.30	±0.05

20 Packing Information

20.1 Tape and Reel Data

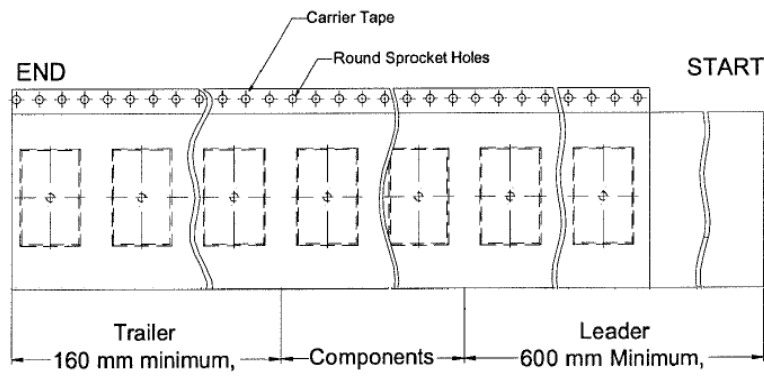
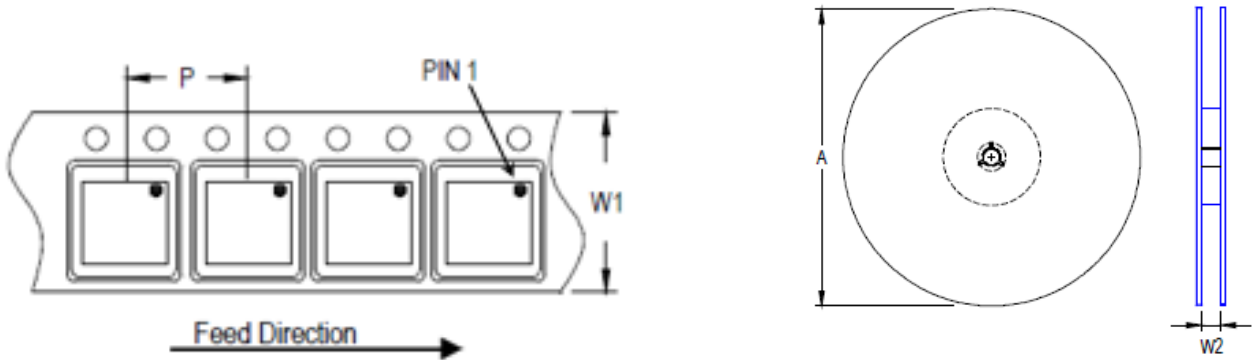

Package Type	Tape Size (W1) (mm)	Pocket Pitch (P) (mm)	Reel Size (A)		Units per Reel	Trailer (mm)	Leader (mm)	Reel Width (W2) Min./Max. (mm)
			(mm)	(in)				
QFN/DFN 3x3	12	8	180	7	1,500	160	600	12.4/14.4

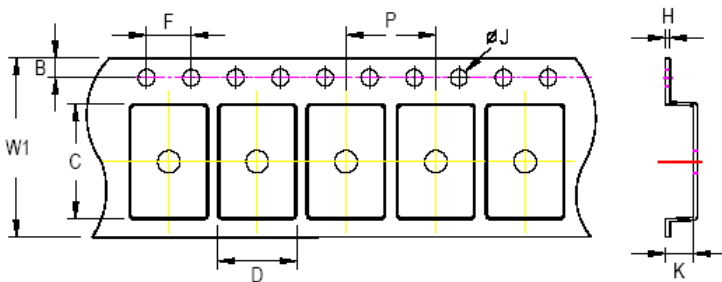







C, D, and K are determined by component size. The clearance between the components and the cavity is as follows:

- For 12mm carrier tape: 0.5mm max.

Tape Size	W1		P		B		F		ØJ		H
	Max.	Min.	Max.	Min.	Max.	Min.	Max.	Min.	Max.	Max.	
12mm	12.3mm	7.9mm	8.1mm	1.65mm	1.85mm	3.9mm	4.1mm	1.5mm	1.6mm	0.6mm	

20.2 Tape and Reel Packing

Step	Photo/Description	Step	Photo/Description
1	 <p>Reel 7"</p>	4	 <p>3 reels per inner box Box A</p>
2	 <p>HIC & Desiccant (1 Unit) inside</p>	5	 <p>12 inner boxes per outer box</p>
3	 <p>Caution label is on backside of Al bag</p>	6	 <p>Outer box Carton A</p>

Container Package	Reel		Box				Carton			
	Size	Units	Item	Size(cm)	Reels	Units	Item	Size(cm)	Boxes	Unit
QFN/DFN 3x3	7"	1,500	Box A	18.3*18.3*8.0	3	4,500	Carton A	38.3*27.2*38.3	12	54,000
			Box E	18.6*18.6*3.5	1	1,500	For Combined or Partial Reel.			

20.3 Packing Material Anti-ESD Property

Surface Resistance	Aluminum Bag	Reel	Cover tape	Carrier tape	Tube	Protection Band
Ω/cm^2	10^4 to 10^{11}	10^4 to 10^{11}	10^4 to 10^{11}	10^4 to 10^{11}	10^4 to 10^{11}	10^4 to 10^{11}

Richtek Technology Corporation

14F, No. 8, Tai Yuen 1st Street, Chupei City

Hsinchu, Taiwan, R.O.C.

Tel: (8863)5526789



Richtek products are sold by description only. Richtek reserves the right to change the circuitry and/or specifications without notice at any time. Customers should obtain the latest relevant information and data sheets before placing orders and should verify that such information is current and complete. Richtek cannot assume responsibility for use of any circuitry other than circuitry entirely embodied in a Richtek product. Information furnished by Richtek is believed to be accurate and reliable. However, no responsibility is assumed by Richtek or its subsidiaries for its use; nor for any infringements of patents or other rights of third parties which may result from its use. No license is granted by implication or otherwise under any patent or patent rights of Richtek or its subsidiaries.

Copyright © 2024 Richtek Technology Corporation. All rights reserved.  is a registered trademark of Richtek Technology Corporation.

www.richtek.com

DSQ2510-QA-03 January 2024

21 Datasheet Revision History

Version	Date	Description	Item
03	2024/1/31	Modify	Absolute Maximum Ratings on P5 Recommended Operating Conditions on P5 Thermal Information on P5 Note 4, Note 5 on P7 Application Information on P14 Packing Information on P18, 19, 20

X-ON Electronics

Largest Supplier of Electrical and Electronic Components

Click to view similar products for [LDO Voltage Regulators](#) category:

Click to view products by [Richtek](#) manufacturer:

Other Similar products are found below :

[AP7363-SP-13](#) [NCV8664CST33T3G](#) [L79M05TL-E](#) [AP7362-HA-7](#) [PT7M8202B12TA5EX](#) [TCR3DF185,LM\(CT](#) [TLF4949EJ](#)
[NCP4687DH15T1G](#) [NCV8703MX30TCG](#) [LP2951CN](#) [NCV4269CPD50R2G](#) [AP7315-25W5-7](#) [NCV47411PAAJR2G](#) [AP2111H-1.2TRG1](#)
[ZLDO1117QK50TC](#) [AZ1117ID-ADJTRG1](#) [NCV4263-2CPD50R2G](#) [NCP706ABMX300TAG](#) [NCP114BMX075TCG](#) [MC33269T-3.5G](#)
[TLE4471GXT](#) [AP7315-33SA-7](#) [NCV4266-2CST33T3G](#) [NCP715SQ15T2G](#) [NCV8623MN-50R2G](#) [NCV563SQ18T1G](#) [NCV8664CDT33RKG](#)
[NCV4299CD250R2G](#) [NCP715MX30TBG](#) [NCV8702MX25TCG](#) [TLE7270-2E](#) [NCV562SQ25T1G](#) [AP2213D-3.3TRG1](#) [AP2202K-2.6TRE1](#)
[NCV8170BMX300TCG](#) [NCV8152MX300180TCG](#) [NCP700CMT45TBG](#) [AP7315-33W5-7](#) [NCP154MX180300TAG](#) [AP2113AMTR-G1](#)
[NJW4104U2-33A-TE1](#) [MP2013AGG-5-P](#) [NCV8775CDT50RKG](#) [NJM2878F3-45-TE1](#) [S-19214B00A-V5T2U7](#) [S-19214B50A-V5T2U7](#) [S-](#)
[19213B50A-V5T2U7](#) [S-19214BC0A-E8T1U7*1](#) [S-19213B00A-V5T2U7](#) [S-19213B33A-V5T2U7](#)