

BMD-300

Stand-alone Bluetooth low energy module

Data sheet



Abstract

This technical data sheet describes the BMD-300 stand-alone Bluetooth® low energy module. The OEMs can embed their own application on top of the integrated Bluetooth low energy stack using Nordic Semiconductor SDK integrated development environment (IDE).

Document information

Title	BMD-300	
Subtitle	Stand-alone Bluetooth low energy module	
Document type	Data sheet	
Document number	UBX-19033350	
Revision and date	R26	19-Jul-2021
Disclosure restriction	C1-Public	

Product status	Corresponding content status	
Functional sample	Draft	For functional testing. Revised and supplementary data will be published later.
In development / Prototype	Objective specification	Target values. Revised and supplementary data will be published later.
Engineering sample	Advance information	Data based on early testing. Revised and supplementary data will be published later.
Initial production	Early production information	Data from product verification. Revised and supplementary data may be published later.
Mass production / End of life	Production information	Document contains the final product specification.

This document applies to the following products:

Product name	Type number	Firmware version	IN/PCN reference	Product status
BMD-300	BMD-300-A-R-00	All	UBX-19039722	Mass production
BMD-300	BMD-300-A-R-10	AE	UBX-20007336	Mass production
BMD-300	BMD-300-A-R-20	AE	UBX-21028574	Initial production

u-blox or third parties may hold intellectual property rights in the products, names, logos, and designs included in this document. Copying, reproduction, modification, or disclosure to third parties of this document or any part thereof is only permitted with the express written permission of u-blox.

The information contained herein is provided "as is" and u-blox assumes no liability for its use. No warranty, either express or implied, is given, including but not limited to, with respect to the accuracy, correctness, reliability, and fitness for a particular purpose of the information. This document may be revised by u-blox at any time without notice. For the most recent documents, visit www.u-blox.com.

Copyright © u-blox AG.

Contents

Document information	2
Contents	3
1 Functional description.....	5
1.1 Features	5
1.2 Applications	5
1.3 Block diagram	6
1.4 Product specifications	7
2 Pin definition.....	9
2.1 Pin assignment.....	9
2.2 Peripheral pin assignments	10
3 Electrical specifications.....	12
3.1 Absolute maximum ratings	12
3.2 Operating conditions.....	12
3.3 General purpose I/O	12
3.4 Peripheral pin assignments	13
3.5 Module reset	13
3.6 Debug and programming.....	13
3.7 Clocks	13
3.7.1 32.768 kHz crystal (LFXO).....	14
3.7.2 32.768 kHz clock source comparison.....	14
4 Firmware.....	15
4.1 Factory image	15
4.1.1 Firmware version “AA”	15
4.1.2 Firmware version “AB”	15
4.1.3 Firmware version “AC”	15
4.1.4 Firmware version “AD”	16
4.1.5 Firmware version “AE”	16
4.2 Module programming and read-back protection	16
4.3 SoftDevices	16
4.3.1 S132	17
4.3.2 S212	17
4.3.3 S332	17
4.4 Bluetooth device address	17
5 Mechanical specifications.....	18
5.1 Dimensions.....	18
5.2 Recommended PCB land pads	18
5.3 Module marking.....	19
5.3.1 BMD-300-A-R-00 module marking	19
5.3.2 BMD-300-A-R-10 and BMD-300-A-R-20 module marking	20
6 RF design notes	21

6.1	Recommended RF layout and ground plane.....	21
6.2	Mechanical enclosure.....	21
6.3	Antenna patterns.....	22
6.3.1	X-Y plane.....	22
6.3.2	X-Z plane.....	23
6.3.3	Y-Z plane	23
7	BMD-300 evaluation development kit.....	24
8	Qualification and approvals	25
8.1	United States (FCC):	25
8.1.1	Labeling and user information requirements	25
8.1.2	RF exposure	25
8.2	Canada (ISED).....	26
8.2.1	Labeling and user information requirements	26
8.2.2	RF exposure	26
8.3	European Union regulatory compliance	27
8.3.1	Radio Equipment Directive (RED) 2014/53/EU	27
8.3.2	Labeling and user information requirements	27
8.4	Japan (MIC).....	27
8.5	Australia / New Zealand (RCM)	27
8.6	South Korea (KCC).....	28
8.7	Brazil (ANATEL).....	28
8.8	Mexico (IFETEL)	28
8.9	Bluetooth qualification.....	28
9	Environmental.....	29
9.1	RoHS.....	29
9.2	REACH.....	29
9.3	California proposition 65 (P65)	29
10	Product handling	30
10.1	Packaging	30
10.1.1	BMD-300-A-R-00 reel packaging	30
10.1.2	BMD-300-A-R-10 and BMD-300-A-R-20 reel packaging	30
10.1.3	BMD-300-A-R-00 carrier tape dimensions.....	31
10.1.4	BMD-300-A-R-10 and BMD-300-A-R-20 carrier tape dimensions.....	31
10.2	Moisture sensitivity level.....	31
10.3	Reflow soldering	32
10.4	ESD precautions.....	32
11	Ordering information	33
12	Life support and other high-risk warnings	34
	Related documents	35
	Revision history	35
	Contact.....	37

1 Functional description

The BMD-300 is a powerful, highly flexible, ultra-low power Bluetooth low energy module based on the nRF52832 SoC from Nordic Semiconductor. With an Arm® Cortex®-M4 with FPU 32-bit processor, embedded 2.4GHz transceiver, and integrated antenna, the BMD-300 provides a complete RF solution with no additional RF design, allowing faster time to market. Providing full use of the nRF52832's capabilities and peripherals, the BMD-300 can power the most demanding applications, all while simplifying designs and reducing BOM costs. With an internal DC-DC converter and intelligent power control, the BMD-300 provides class-leading power efficiency, enabling ultra-low power sensitive applications. Regulatory pre-approvals reduce the burden to enter the market.

1.1 Features

- Based on the Nordic Semiconductor nRF52832 SoC
- Bluetooth 5 PHYs: LE 1M, LE 2M
- Bluetooth 5 features: Advertising Extensions, Channel Selection Algorithm #2
- Bluetooth mesh
- Complete RF solution with an integrated DC-DC converter
- Nordic Semiconductor SoftDevice ready
- Over-the-Air (OTA) firmware updates
- No external components required
- Arm® Cortex®-M4 with FPU 32-bit processor
- 512 kB embedded flash memory
- 64 kB RAM
- -40 °C to +85 °C Temperature range
- 32 General Purpose I/O Pins
- 12-bit/200 KSPS ADC
- Serial Wire Debug (SWD)
- Three SPI Master/Slave (8 Mbps)
- Two 2-wire Master/Slave (I2C compatible)
- Footprint compatible with BMD-301, BMD-330, BMD-360, and BMD-340 (superset)
- UART (w/ CTS/RTS and DMA)
- I2S audio interface
- Low power comparator
- Temperature sensor
- Random number generator
- 20 channel CPU independent Programmable Peripheral Interconnect (PPI)
- Quadrature Demodulator (QDEC)
- 128-bit AES HW encryption
- 5 x 32 bit, 3 x 24 bit Real Timer Counters (RTC)
- NFC-A tag interface for OOB pairing
- Dimensions: 14 x 9.8 x 1.9 mm
- USA (FCC): 2AA9B04
- Canada (IC): 12208A-04
- Japan (MIC): 210-106799

1.2 Applications

- Beacons – iBeacon™, Eddystone, AltBeacon, etc.
- Low-power sensors
- Fitness devices
- Wearables

- Climate control
- Lighting
- Safety and security
- Home appliances
- Access control
- Internet of Things
- Home health care
- Advanced remote controls
- Smart energy management
- Low-power sensor networks
- Interactive entertainment
- Key fobs
- Environmental monitoring
- Hotel automation
- Office automation

1.3 Block diagram

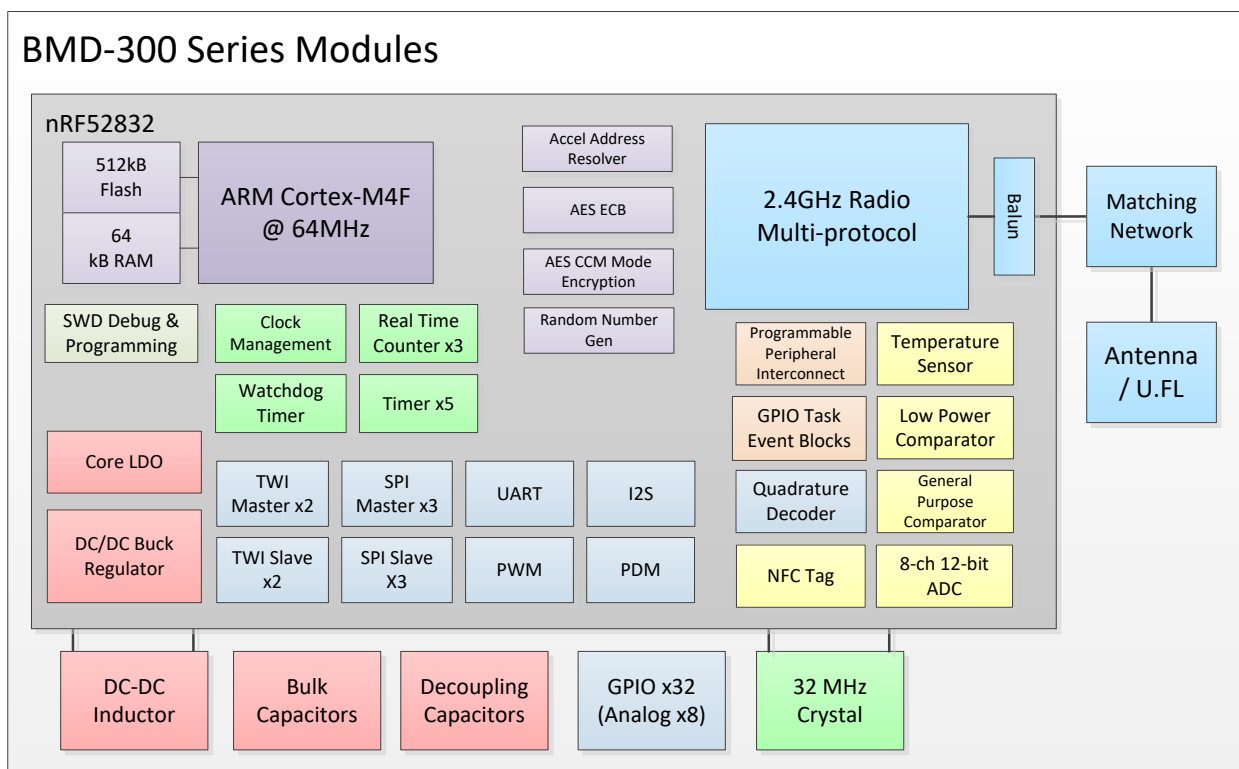

Figure 1: Block diagram of BMD-300

1.4 Product specifications

Detail	Description
Bluetooth	
Bluetooth version	Bluetooth 5 low energy, Concurrent Central & Peripheral (S132), 2M LE PHY, 1M LE PHY, Advertising Extensions, CSA #2 Bluetooth Mesh
Security	AES-128
LE connections	Concurrent central, observer, peripheral, and broadcaster roles with up to twenty concurrent connections along with one Observer and one Broadcaster (S132)
Radio	
Frequency	2.360 GHz to 2.500 GHz
Modulations	GFSK at 1 Mbps, 2 Mbps data rates
Transmit power	+4 dBm maximum
Receiver sensitivity	-96 dBm (Bluetooth low energy mode)
Antenna	Integrated (-1dBi peak)
Current consumption	
TX only @ +4 dBm, 0 dBm @ 3V, DCDC enabled	7.5 mA, 5.3 mA
TX only @ +4 dBm, 0 dBm	16.6 mA, 11.6 mA
RX only @ 1 Mbps @ 3V, DCDC enabled	5.4 mA
RX only @ 1 Mbps	11.7 mA
CPU @ 64MHz from flash, from RAM	7.4 mA, 6.7 mA
CPU @ 64MHz from flash, from RAM @ 3V, DCDC	3.7 mA, 3.3 mA
System Off, On	0.3 μ A, 1.2 μ A
Additional current for RAM retention	30 nA / 4KB block
Dimensions	
Length	14.0 mm \pm 0.3mm
Width	9.8 mm \pm 0.3mm
Height	1.9 mm \pm 0.1mm
Hardware	
Interfaces	SPI Master/Slave x 3 UART Two-Wire Master/Slave (I2C) x 2 I2S PWM PDM GPIO x 32
Power supply	1.7 V to 3.6 V
Temperature range	-40 $^{\circ}$ C to +85 $^{\circ}$ C
Certifications	
USA (FCC)	FCC part 15.247 modular certification FCC ID: 2AA9B04
Canada (ISED)	ISED RSS-247 modular certification IC: 12208A-04
Europe (CE)	EN 62368-1:2014+A11:2017 EN 62479:2010 EN 301 489-1 V2.1.1 EN 301 489-17 V3.2.0 EN 300 328 V2.2.2

Detail	Description
Japan (MIC)	Ministry of Internal Affairs and Communications (MIC) of Japan pursuant to the Radio Act of Japan: MIC: 210-106799
Australia / New Zealand (RCM)	AS/NZS 4268:2017, Radio equipment and systems – Short range devices
South Korea (KCC)	Certified under Clause 2, Article 58-2 of the Radio Waves Act: R-CRM-Rgd-BMD-300
Brazil (ANATEL)	Resolution 680 of 27/06/2017, Act 14448 of 04/12/2017 Certificate number: 00820-21-05903
Mexico (IFETEL)	Modular certification: NYCE/CT/0146/17/TS
Bluetooth	BMD-300/301 BT5 RF-PHY Component (Tested) – DID: D037298; QDID: 101625
Radio chip	
Nordic Semiconductor nRF52832	Additional details: nRF52832 Product Specification [3] nRF Connect SDK [4] nRF5 Software Development Kit [5]

Table 1: Product specifications

2 Pin definition

The BMD-300, BMD-301, BMD-330, and BMD-360 share an identical pin-out. This pin-out is also a subset of the BMD-340 footprint, allowing a single design to support any of these modules.

2.1 Pin assignment

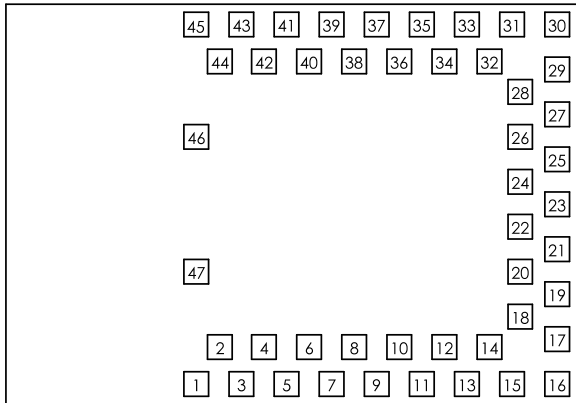

Figure 2: BMD-300 Pin assignment (top view)

No.	Name	I/O	Description	nRF52 pin	Remarks
1	GND	Power	Electrical Ground		
2	GND	Power	Electrical Ground		
3	GND	Power	Electrical Ground		
4	GND	Power	Electrical Ground		
5	GND	Power	Electrical Ground		
6	P0.25	I/O	GPIO	P0.25	Use as low drive, low frequency GPIO only Add 12 pF capacitance to ground. See Nordic Semiconductor errata 138 [6]
7	P0.26	I/O	GPIO	P0.26	Use as low drive, low frequency GPIO only Add 12 pF capacitance to ground. See Nordic Semiconductor errata 138 [6]
8	P0.27	I/O	GPIO	P0.27	Use as low drive, low frequency GPIO only
9	P0.28	I/O	GPIO/AIN4	P0.28	Pin is analog capable, use as low drive, low frequency GPIO only
10	P0.29	I/O	GPIO/AIN5	P0.29	Pin is analog capable, use as low drive, low frequency GPIO only
11	P0.30	I/O	GPIO/AIN6	P0.30	Pin is analog capable, use as low drive, low frequency GPIO only
12	P0.31	I/O	GPIO/AIN7	P0.31	Pin is analog capable, use as low drive, low frequency GPIO only
13	P0.00	I/O	GPIO/XTAL1 (32.768 kHz)	P0.00	
14	P0.01	I/O	GPIO/XTAL2 (32.768 kHz)	P0.01	
15	P0.02	I/O	GPIO/AIN0	P0.02	Pin is analog capable
16	GND	Power	Electrical Ground		
17	VCC	Power	+1.7V to +3.6V		An internal 4.7 μ F bulk capacitor is included on the module. However, it is good design practice to add additional bulk capacitance as required for your application, i.e., those with heavy GPIO usage and/or current draw.

No.	Name	I/O	Description	nRF52 pin	Remarks
18	GND	Power	Electrical Ground		
19	P0.03	I/O	GPIO/AIN1	P0.03	Pin is analog capable
20	P0.04	I/O	GPIO/AIN2	P0.04	Pin is analog capable
21	P0.05	I/O	GPIO/AIN3	P0.05	Pin is analog capable
22	P0.06	I/O	GPIO	P0.06	
23	P0.07	I/O	GPIO	P0.07	
24	P0.08	I/O	GPIO	P0.08	
25	P0.09	I/O	GPIO/NFC1	P0.09	NFC pin 1 (default)
26	P0.10	I/O	GPIO/NFC2	P0.10	NFC pin 2 (default)
27	P0.11	I/O	GPIO	P0.11	
28	P0.12	I/O	GPIO	P0.12	
29	GND	Power	Electrical Ground		
30	GND	Power	Electrical Ground		
31	P0.13	I/O	GPIO	P0.13	
32	P0.14	I/O	GPIO/TRACEDATA[3]	P0.14	
33	P0.15	I/O	GPIO/TRACEDATA[2]	P0.15	
34	P0.16	I/O	GPIO/TRACEDATA[1]	P0.16	
35	P0.17	I/O	GPIO	P0.17	
36	P0.18	I/O	GPIO/TRACEDATA[0] /SWO	P0.18	
37	P0.19	I/O	GPIO	P0.19	
38	P0.20	I/O	GPIO/TRACECLK	P0.20	
39	P0.21	I/O	GPIO/RESET_N	P0.21	May be used as active low reset input
40	P0.22	I/O	GPIO	P0.22	Use as low drive, low frequency GPIO only
41	P0.23	I/O	GPIO	P0.23	Use as low drive, low frequency GPIO only
42	P0.24	I/O	GPIO	P0.24	Use as low drive, low frequency GPIO only
43	SWCLK	I	SWD Clock	SWCLK	
44	SWDIO	I/O	SWD IO	SWDIO	
45	GND	Power	Electrical Ground		
46	GND	Power	Electrical Ground		
47	GND	Power	Electrical Ground		

Table 2: BMD-300 pin-out

2.2 Peripheral pin assignments

The peripherals within the BMD-300 may be assigned to nearly any of the GPIO pins through the application. There are some restrictions called out by the nRF52832 product specification. See the Remarks in **Error! Reference source not found..** Also note that certain peripherals are assigned to particular pins, such the analog inputs.

 Only one peripheral signal can be multiplexed to a GPIO pin at a time. Trace signals, analog inputs, XTAL signals, SWD interface, and reset are restricted to certain pins due to additional internal circuitry required by the interface. See Table 3.

Peripheral	Signal	Pin options
UART0, I2C0, SPI0, SPI1, PDM, PWM0	All	P0.00-P0.31
ADC, COMP, LPCOMP	All	P0.02-P0.05, P0.28-P0.31 (AIN0-AIN7)
Reset	RESET_N	P0.21

Peripheral	Signal	Pin options
SWD	SWD Clock	SWCLK
	SWD IO	SWDIO
32.768 kHz Crystal	XTAL1	P0.00
	XTAL2	P0.01

Table 3: Peripheral pin options

3 Electrical specifications

Stressing the device above one or more of the ratings listed in the [Absolute maximum ratings](#) can cause permanent damage. These are stress ratings only. Operating the module at these or at any conditions other than those specified in the [Operating conditions](#) should be avoided. Exposure to absolute maximum rating conditions for extended periods can affect device reliability.

Operating condition ranges define those limits within which the functionality of the device is guaranteed. Where application information is given, it is advisory only and does not form part of the specification.

3.1 Absolute maximum ratings

Symbol	Description	Min	Max	Unit
V_{CC_MAX}	Voltage on supply pin	-0.3	3.9	V
V_{IO_MAX}	Voltage on GPIO pins ($V_{CC} > 3.6$ V)	-0.3	3.9	V
V_{IO_MAX}	Voltage on GPIO pins ($V_{CC} \leq 3.6$ V)	-0.3	$V_{CC} + 0.3$ V	V
T_s	Storage Temperature Range	-40	125	°C

Table 4: Absolute maximum ratings

The product is not protected against overvoltage or reversed voltages. If necessary, voltage spikes exceeding the power supply voltage specification, given in table above, must be limited to values within the specified boundaries by using appropriate protection devices.

3.2 Operating conditions

Unless otherwise specified, all operating condition specifications are at an ambient temperature of 25 °C and a supply voltage of 3.0 V.

Operation beyond the specified operating conditions is not recommended and extended exposure beyond them may affect device reliability.

Symbol	Parameter	Min	Typ.	Max	Unit
V_{CC}	Operating supply voltage	1.7	3.0	3.6	V
T_{R_VCC}	Supply rise time (0 V to 1.7 V)	-	-	60	ms
T_A	Operating ambient temperature range	-40	25	85	°C

Table 5: Operating conditions

3.3 General purpose I/O

The general purpose I/O is organized as one port enabling access and control of the 32 available GPIO pins via one port, P0. Each GPIO can be accessed with the following user configurable features:

- Input/output direction
- Output drive strength
- Internal pull-up and pull-down resistors
- Wake-up from high- or low-level triggers on all pins
- Trigger interrupt on all pins
- All pins can be used by the PPI task/event system; the maximum number of pins that can be interfaced through the PPI at the same time is limited by the number of GPIOTE channels
- All pins can be individually configured to carry serial interface or quadrature demodulator signals

Symbol	Parameter	Min	Typ.	Max	Unit
V_{IH}	Input high voltage	$0.7 \times VCC$	-	VCC	V
V_{IL}	Input low voltage	VSS	-	$0.3 \times VCC$	V
V_{OH}	Output high voltage	$VCC - 0.4$	-	VCC	V
V_{OL}	Output low voltage	VSS	-	$VSS + 0.4$	V
R_{PU}	Pull-up resistance	11	13	16	$k\Omega$
R_{PD}	Pull-down resistance	11	13	16	$k\Omega$

Table 6: GPIO

3.4 Peripheral pin assignments

The peripherals within the BMD-300 may be assigned to nearly any of the GPIO pins through the application. There are some restrictions called out by the nRF52832 product specification. See the remarks column of Table 2. Also note that certain peripherals are assigned to particular pins, such as the analog inputs and NFC antenna.

3.5 Module reset

GPIO pin P0.21 may be used for a hardware reset. In order to utilize P0.21 as a hardware reset, the UICR registers PSELRESET[0] and PSELRESET[1] must be set alike, to the value of 0x7FFFFFFF. When P0.21 is programmed as RESET, the internal pull-up is automatically enabled. Nordic Semiconductor example applications and development kits program P0.21 as RESET_N.

3.6 Debug and programming

The BMD-300 supports the two pin Serial Wire Debug (SWD) interface and offers flexible and powerful mechanism for non-intrusive debugging of program code. Breakpoints, single stepping, and instruction trace capture of code execution flow are part of this support.

The BMD-300 also supports ETM and ITM trace. Trace data from the ETM and the ITM is sent to an external debugger via a 4-bit wide parallel trace port. In addition to parallel trace, the TPIU supports serial trace via the Serial Wire Output (SWO) trace protocol.

3.7 Clocks

The BMD-300 requires two clocks, a high frequency clock and a low frequency clock.

The high frequency clock is provided on-module by a high-accuracy 32 MHz crystal as required by the nRF52832 for radio operation.

The low frequency clock can be provided internally by an RC oscillator or synthesized from the fast clock, or externally by a 32.768 kHz crystal. An external crystal provides the lowest power consumption and greatest accuracy. Using the internal RC oscillator with calibration provides acceptable performance for Bluetooth low energy applications at a reduced cost and slight increase in power consumption.

 The ANT protocol requires the use of an external crystal.

3.7.1 32.768 kHz crystal (LFXO)

Symbol	Parameter	Typ.	Max.	Unit
F_{NOM_LFXO}	Crystal frequency	32.768	-	kHz
$F_{TOL_LFXO_BLE}$	Frequency tolerance, Bluetooth low energy applications ¹	-	±250	ppm
$f_{TOL_LFXO_ANT}$	Frequency Tolerance, ANT applications ¹	-	±50	ppm
C_{L_LFXO}	Load capacitance	-	12.5	pF
C_{0_LFXO}	Shunt capacitance	-	2	pF
R_{S_LFXO}	Equivalent series resistance	-	100	kΩ
C_{pin}	Input capacitance on XL1 & XL2 pads	4	-	pF

Table 7: 32.768 kHz crystal (LFXO)

3.7.2 32.768 kHz clock source comparison

Symbol	Parameter	Min.	Typ.	Max.	Unit
I_{LFXO}	Current for 32.768 kHz Crystal oscillator	-	0.25	-	μA
I_{LFRC}	Current for 32.768 kHz RC oscillator	-	0.6	1	μA
I_{LFSYNT}	Current for 32.768 kHz Synthesized oscillator	-	100	-	μA
$f_{TOL_LFXO_BLE}$	Frequency Tolerance, 32.768 kHz Crystal oscillator (Bluetooth low energy Stack) ¹	-	-	±250	ppm
$f_{TOL_LFXO_ANT}$	Frequency Tolerance, 32.768 kHz Crystal oscillator (ANT Stack) ¹	-	-	±50	ppm
f_{TOL_LFRC}	Frequency Tolerance, 32.768 kHz RC oscillator	-	-	±2	%
$f_{TOL_CAL_LFRC}$	Frequency tolerance, 32.768 kHz RC after calibration	-	-	±250	ppm
f_{TOL_LFSYNT}	Frequency Tolerance, 32.768 kHz Synthesized oscillator	-	-	±48	ppm

Table 8: 32.768 kHz clock source comparison

¹ $f_{TOL_LFXO_BLE}$ and $f_{TOL_LFXO_ANT}$ are the maximum allowed for Bluetooth low energy and ANT applications. Actual tolerance depends on the crystal used.

4 Firmware

Projects for the BMD-360 should utilize the Nordic Semiconductor nRF Connect SDK [4] and the nRF52832 tools for new development. The tools allow access to the very latest Bluetooth support from Nordic Semiconductor and provide an ongoing path as new features are released.

The nRF5 SDK **Error! Reference source not found.** can also be used if the feature set of the SDK meets the application requirements.

 For legacy applications, source code is provided through our GitHub repositories for RigDFU, BMDware, Rigablue, developer tools, and mobile apps for customers to customize and extend on their own.

4.1 Factory image

The factory programmed firmware version is indicated on the label. Programming of the factory image is maintained solely for legacy applications. New development should use the latest [Nordic Semiconductor SDK and examples](#).

4.1.1 Firmware version “AA”

- RigDFU v3.2.0 (42)
- Nordic Semiconductor S132 SoftDevice v2.0.0
- BMDware v3.1.0 (50)
- Read-back protection *enabled*.

Modules can be programmed with customer code after a full-chip erase via the SWD interface.

 A full-chip erase will clear the assigned public Bluetooth device (MAC) address from memory. With Firmware Version AA and AB, the MAC address must be manually recovered.

4.1.2 Firmware version “AB”

- RigDFU v3.2.1 (43)
- Nordic Semiconductor S132 SoftDevice v2.0.0
- BMDware v3.1.1 (51)
- Read-back protection *enabled*.

Modules can be programmed with customer code after a full-chip erase via the SWD interface.

 A full-chip erase will clear the assigned public Bluetooth device (MAC) address from memory. With Firmware Version AA and AB, the MAC address must be manually recovered.

4.1.3 Firmware version “AC”

- RigDFU v3.2.2 (44)
- Nordic Semiconductor S132 SoftDevice v2.0.0
- BMDware v3.1.1 (51)
- Read-back protection *disabled*.

Modules can be programmed with customer code after a full-chip erase via the SWD interface.

 A full chip erase clears the assigned public Bluetooth device (MAC) address from memory. See also [Bluetooth device address](#).

4.1.4 Firmware version “AD”

- RigDFU v3.3.1 (46)
- Nordic Semiconductor S132 SoftDevice v3.1.0
- BMDware v3.2.1 (60)
- Read-back protection *disabled*.

Modules can be programmed with customer code after a full-chip erase via the SWD interface.

 A full chip erase clears the assigned public Bluetooth device (MAC) address from memory. See also [Bluetooth device address](#).

4.1.5 Firmware version “AE”

- RigDFU v3.4.0 (47)
- Nordic Semiconductor S132 SoftDevice v3.1.0
- BMDware v3.2.1 (60)
- Read-back protection *disabled*.

Modules can be programmed with customer code after a full-chip erase via the SWD interface.

 A full chip erase will clear the assigned public Bluetooth device (MAC) address from memory. See also [Bluetooth device address](#).

 “AE” marked modules *may not* be loaded with previous factory firmware versions due to Nordic Semiconductor nRF52832 Errata #108. “AA” through “AD” marked modules may be loaded with any Factory Firmware version, including “AE”.

 Type numbers BMD-300-A-R-10 and BMD-300-A-R-20 are loaded with firmware version “AE” only.

4.2 Module programming and read-back protection

For legacy applications, RigDFU allows for UART and OTA updates to RigDFU, the SoftDevice and application firmware.

In order to utilize the SWD port on “AA” and “AB” marked modules, the nRF52832 must be erased and recovered. Without this step, the module will not be recognized by most programmers. This is accomplished through *nrfjprog*, which is provided with the Nordic Semiconductor command line utilities:

```
nrfjprog -f nrf52 --recover
```

 A full chip erase is performed, so all components will need to be re-loaded (bootloader, SoftDevice, application firmware, and if used the public Bluetooth device address).

The BMD-300 module may be restored to the factory firmware versions noted above with the utilities available at our GitHub repositories.

4.3 SoftDevices

Nordic Semiconductor protocol stacks are known as SoftDevices. SoftDevices are pre-compiled, pre-linked binary files. SoftDevices can be programmed in nRF52 series SoCs and are downloadable from the Nordic Semiconductor website. The BMD-300 with the nRF52832 SoC supports the S132 (Bluetooth low energy Central & Peripheral), S212 (ANT) and S312 (ANT and Bluetooth low energy) SoftDevices.

4.3.1 S132

The S132 SoftDevice is a Bluetooth® low energy Central and Peripheral protocol stack solution supporting up to twenty connections with an additional Observer and a Broadcaster role all running concurrently. The S132 SoftDevice integrates a Bluetooth low energy Controller and Host and provides a full and flexible API for building Bluetooth Smart nRF52 System on Chip (SoC) solutions.

4.3.2 S212

The S212 SoftDevice is an ANT™ protocol stack solution that provides a full and flexible Application Programming Interface (API) for building ANT System on Chip (SoC) solutions for the nRF52832 chip. The S212 SoftDevice simplifies combining the ANT protocol stack and an application on the same CPU. See the [ANT+ website](#) for membership in the ANT+ Alliance and S212 licensing.

4.3.3 S332

The S332 SoftDevice is a combined ANT and Bluetooth low energy protocol stack solution. It supports all four Bluetooth low energy roles (central, peripheral, observer, broadcaster) and ANT.

The S332 SoftDevice provides a full and flexible Application Programming Interface (API) for building concurrent ANT and Bluetooth low energy System on Chip (SoC) solutions. It simplifies combining an ANT and Bluetooth low energy protocol stack and an application on the same CPU, therefore eliminating the need for an added device to support concurrent multiprotocol. See the [ANT+ website](#) for membership in the ANT+ Alliance and S332 licensing.

4.4 Bluetooth device address

The BMD-300 module is preprogrammed from the factory with a unique public Bluetooth device (MAC) address stored in the CUSTOMER[0] and CUSTOMER[1] registers of the User Information Configuration Registers (UICR). The Bluetooth device address consists of the IEEE Organizationally Unique Identifier (OUI) combined with the six hexadecimal digits that are printed on a 2D barcode and in human-readable text on the module label, as described in [Module marking](#). The Bluetooth device address is stored in little endian format. The most significant bytes of the CUSTOMER[1] register are 0xFF to complete the 32-bit register.

UICR Register	Address	Description	Remarks
CUSTOMER[0]	0x10001080	Bluetooth_addr [0] (0xFF)	Example value. Actual value printed on label
CUSTOMER[0]	0x10001081	Bluetooth_addr [1] (0xEE)	Example value. Actual value printed on label
CUSTOMER[0]	0x10001082	Bluetooth_addr [2] (0xDD)	Example value. Actual value printed on label
CUSTOMER[0]	0x10001083	Bluetooth_addr [3] (0xCC)	IEEE OUI ^{2,3}
CUSTOMER[1]	0x10001084	Bluetooth_addr [4] (0xBB)	IEEE OUI ^{2,3}
CUSTOMER[1]	0x10001085	Bluetooth_addr [5] (0xAA)	IEEE OUI ^{2,3}
CUSTOMER[1]	0x10001086	0xFF	Unused
CUSTOMER[1]	0x10001087	0xFF	Unused

Table 9: Bluetooth device address

² The IEEE OUI for type number BMD-300-A-R-00 is: 94:54:93. The second half of the full Bluetooth device address is encoded in the label data matrix. The full Bluetooth device address is stored in the UICR.

³ Type numbers BMD-300-A-R-10 and BMD-300-A-R-20 encode the full Bluetooth device address in the label data matrix and is stored in the UICR.

5 Mechanical specifications

5.1 Dimensions

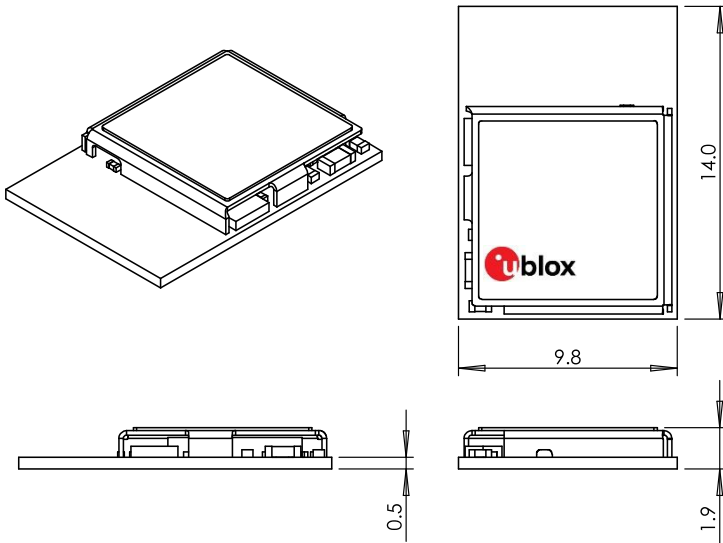

Length: ± 0.3 mm, Width: ± 0.3 mm, Height: ± 0.1 mm

Figure 3: BMD-300 mechanical drawing

5.2 Recommended PCB land pads

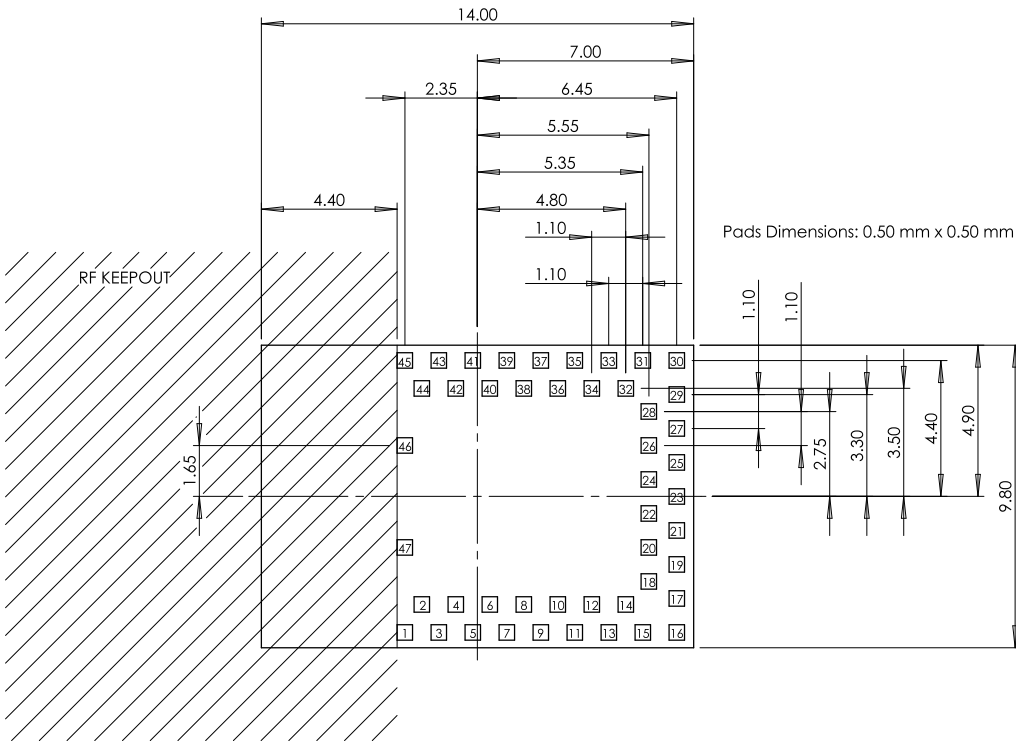

Figure 4: Recommended PCB Land Pads

The RF Keep-out area extends vertically to the board edge.

5.3 Module marking

5.3.1 BMD-300-A-R-00 module marking

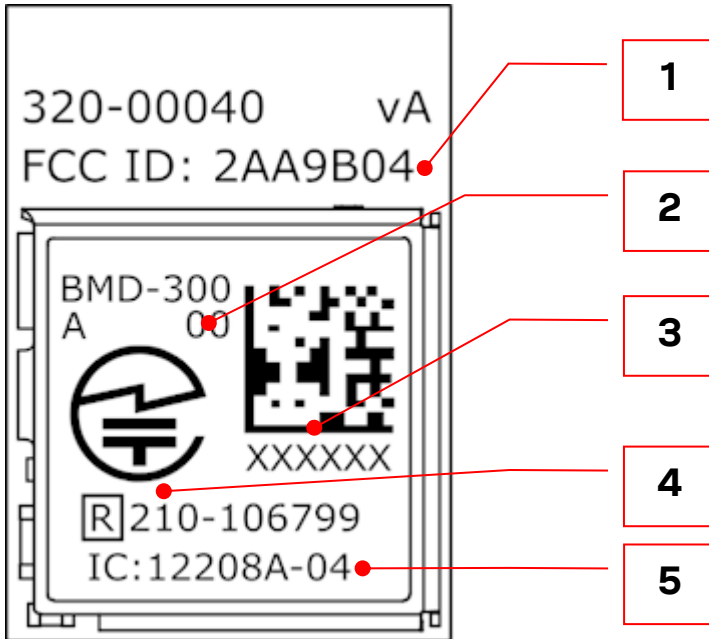

Figure 5: Module marking for type number BMD-300-A-R-00

Reference	Description
1	FCC ID (USA)
2	Firmware version (AA, AB, AC, AD, or AE)
3	Data Matrix with unique serial number of six alphanumeric symbols, also in human-readable form. The full Bluetooth address consists of the IEEE OUI (94:54:93) with the six symbols appended: Example value: 94:54:93:XX:YY:ZZ
4	MIC ID and Giteki mark (Japan)
5	ISED ID (Canada)

Table 10: Module marking for type number BMD-300-A-R-00

5.3.2 BMD-300-A-R-10 and BMD-300-A-R-20 module marking

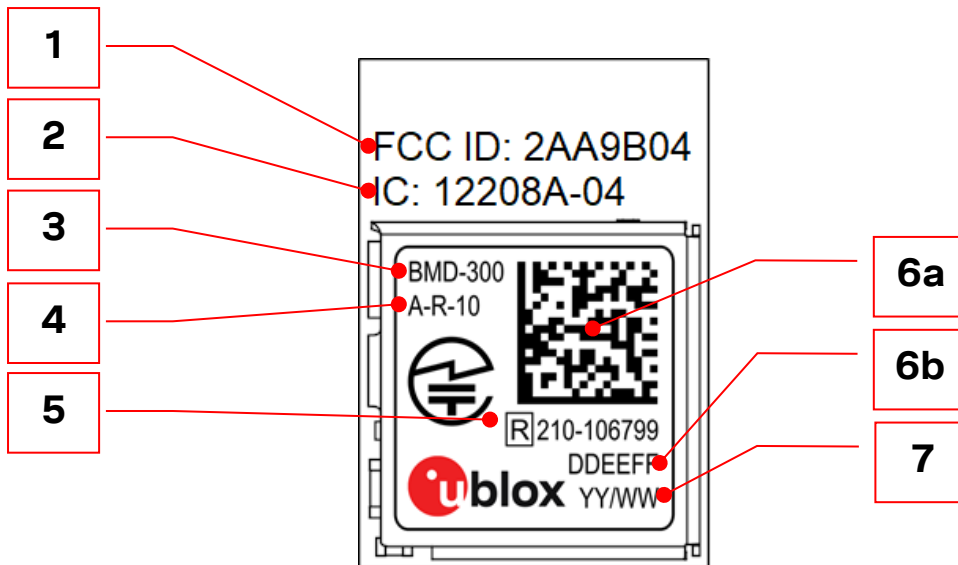

Figure 6: Module marking for type numbers BMD-300-A-R-10 and BMD-300-A-R-20

Reference	Description
1	FCC ID (USA)
2	ISED ID (Canada)
3	Product name
4	Type number (last characters)
5	MIC (Japan) Giteki mark and Certification ID
6a	Data matrix with unique serial number of 19 alphanumeric symbols. The first 3 symbols represent module type number unique to each module variant, the next 12 symbols represent the unique hexadecimal Bluetooth device address of the module AABBCDDEEFF, and the last 4 symbols represent the hardware and firmware version encoded HHFF. Factory firmware version "AE" is encoded as "01" in the data matrix.
6b	Second half of Bluetooth device address in human-readable format (DDEEFF above)
7	Date of production encoded YY/WW (year / week)

Table 11: Module marking for type number BMD-300-A-R-10 and BMD-300-A-R-20

Type number BMD-300-A-R-20 has an additional data matrix on the bottom used only at the factory. Figure 7 shows type number BMD-300-A-R-10 (left) and BMD-300-A-R-20 (right).

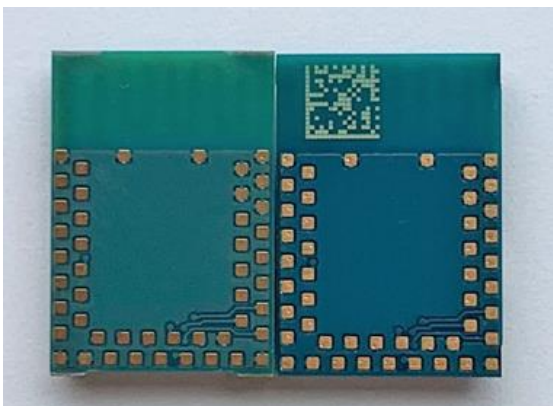

Figure 7: Bottom data matrix on type number BMD-300-A-R-20

6 RF design notes

6.1 Recommended RF layout and ground plane

For the BMD-300, the integrated antenna requires a suitable ground plane to radiate effectively.

The area under and extending out from the antenna portion of the module should be kept clear of copper and other metal. The module should be placed at the edge of the PCB with the antenna edge facing out. Reducing the ground plane from that shown in Figure 8 will reduce the effective radiated power. For example, a 27 mm x 29 mm board (about the size of a coin cell) has approximately 3 dB lower output than the BMD-300 Evaluation Board.

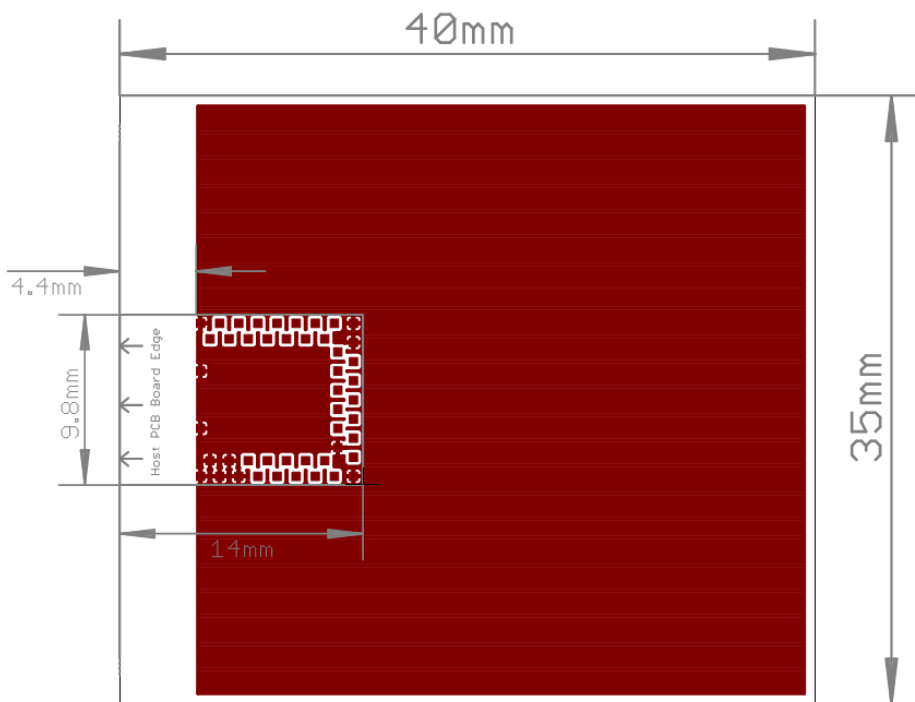

Figure 8: Recommended RF layout and ground plane

6.2 Mechanical enclosure

Care should be taken when designing and placing the BMD-300 into an enclosure. Metal should be kept clear from the antenna area, both above and below. Any metal around the module can negatively impact RF performance.

The module is designed and tuned for the antenna and RF components to be in free air. Any potting, epoxy fill, plastic over-molding, or conformal coating can negatively impact RF performance and must be evaluated by the customer.

6.3 Antenna patterns

Antenna patterns are based on the BMD-300 Evaluation kit with a ground plane size of 82 mm x 56 mm. The X-Y-Z orientation is shown in Figure 9:

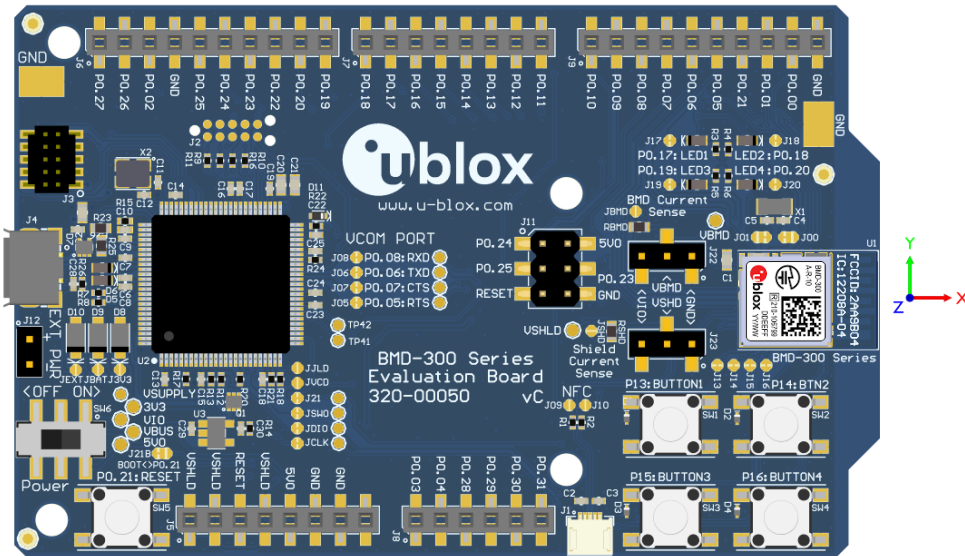

Figure 9: BMD-300 evaluation kit X-Y-Z orientation

6.3.1 X-Y plane

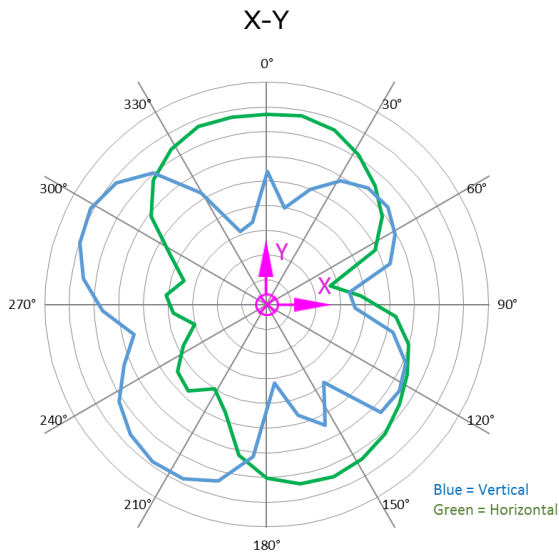

Figure 10: X-Y plane antenna pattern

The outer-most ring is +5 dB. Each division is -5 dB.

6.3.2 X-Z plane

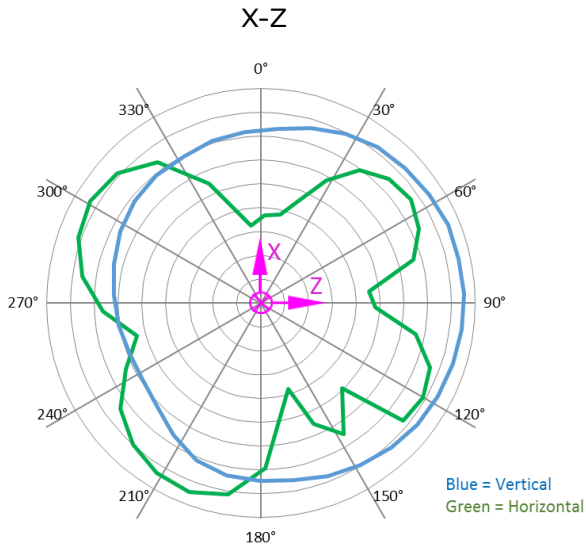

Figure 11: X-Z plane antenna pattern

The outer-most ring is +5 dB. Each division is -5 dB.

6.3.3 Y-Z plane

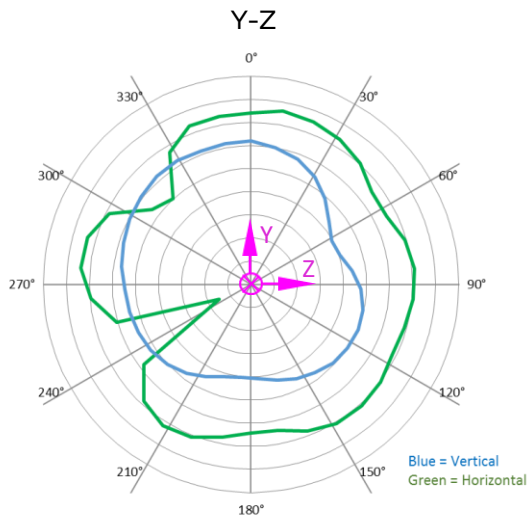

Figure 12: Y-Z plane antenna pattern

The outer-most ring is +5 dB. Each division is -5 dB.

7 BMD-300 evaluation development kit



The BMD-300-EVAL is a full featured evaluation board that provides a complete I/O pin out to headers, on-board programming and debugging, 32.768 kHz crystal, power, and virtual COM port over USB, four user LEDs, and four user buttons. The evaluation boards also provide the option to be powered from a CR2032 coin cell battery and have current sense resistors and headers to allow for convenient current measurements. An Arduino Uno R3 style header is provided for easy prototyping of additional functions. The evaluation boards also support programming off-board BMD-3 series, ANNA-B1, and NINA-B1/B3 series modules.

8 Qualification and approvals

8.1 United States (FCC):

The BMD-300 has received Federal Communications Commission (FCC) CFR47 Telecommunications, Part 15 Subpart C “Intentional Radiators” modular approval in accordance with Part 15.247 Modular Transmitter approval. The modular approval allows the end user to integrate the module into a finished product without obtaining subsequent and separate FCC approvals for intentional radiation, provided no changes or modifications are made to the module circuitry. Changes or modifications could void the user’s authority to operate the equipment. The end user must comply with all of the instructions provided by the Grantee, which indicate installation and/or operating conditions necessary for compliance.

The finished product is required to comply with all applicable FCC equipment authorizations regulations, requirements and equipment functions not associated with the transmitter module portion. For example, compliance must be demonstrated to regulations for other transmitter components within the host product; to requirements for unintentional radiators (Part 15 Subpart B “Unintentional Radiators”), such as digital devices, computer peripherals, radio receivers, etc.; and to additional authorization requirements for the non-transmitter functions on the transmitter module (i.e., Verification, or Declaration of Conformity) (e.g., transmitter modules may also contain digital logic functions) as appropriate.

-  Modification to this product will void the users’ authority to operate this equipment.
-  The OEM is still responsible for verifying end product compliance with FCC Part 15, subpart B limits for unintentional radiators through an accredited test facility.

8.1.1 Labeling and user information requirements

The BMD-300 is assigned the FCC ID number: 2AA9B04

If the FCC ID is not visible when the module is installed inside another device, then the outside of the finished product into which the module is installed must also display a label referring to the enclosed module. This exterior label can use the following or similar wording:

Contains FCC ID: 2AA9B04

In addition to marking the product with the appropriate FCC ID, the end product user manual may also require specific information based on the digital device classification. Refer to the [FCC Rules, Title 47, Subchapter A, Part 15, Subpart B, Chapter §15.105](#) for specific wording of the notices.

8.1.2 RF exposure

All transmitters regulated by FCC must comply with RF exposure requirements. [KDB 447498 General RF Exposure Guidance](#) provides guidance in determining whether proposed or existing transmitting facilities, operations or devices comply with limits for human exposure to Radio Frequency (RF) fields adopted by the Federal Communications Commission (FCC).

This module is approved for installation into mobile and/or portable host platforms and must not be co-located or operating in conjunction with any other antenna or transmitter except in accordance with FCC multi-transmitter guidelines. End users must be provided with transmitter operating conditions for satisfying RF Exposure compliance.

8.2 Canada (ISED)

The BMD-300 module is certified for use in Canada under Innovation, Science and Economic Development Canada (ISED) Radio Standards Specification (RSS) RSS-247 and RSSGen.

8.2.1 Labeling and user information requirements

The BMD-300 is assigned the IC ID number: 12208A-04

Labeling Requirements for the Host Device (from Section 3.2.1, RSS-Gen, Issue 3, December 2010): The host device shall be properly labeled to identify the module within the host device. The Industry Canada certification label of a module shall be clearly visible at all times when installed in the host device, otherwise the host device must be labeled to display the Industry Canada certification number of the module, preceded by the words “Contains transmitter module”, or the word “Contains”, or similar wording expressing the same meaning, as follows:

Contains transmitter module IC: 12208A-04

User Manual Notice for License-Exempt Radio Apparatus (from Section 7.1.3 RSS-Gen, Issue 3, December 2010): User manuals for license-exempt radio apparatus shall contain the following or equivalent notice in a conspicuous location in the user manual or alternatively on the device or both:

This device complies with Industry Canada license exempt RSS standard(s). Operation is subject to the following two conditions: (1) this device may not cause interference, and (2) this device must accept any interference, including interference that may cause undesired operation of the device.

Le présent appareil est conforme aux CNR d'Industrie Canada applicables aux appareils radio exempts de licence. L'exploitation est autorisée aux deux conditions suivantes: (1) l'appareil ne doit pas produire de brouillage, et (2) l'utilisateur de l'appareil doit accepter tout brouillage radioélectrique subi, même si le brouillage est susceptible d'en compromettre le fonctionnement.

Transmitter Antenna (from Section 7.1.2 RSS-Gen, Issue 3, December 2010): User manuals for transmitters shall display the following notice in a conspicuous location:

Under Industry Canada regulations, this radio transmitter may only operate using an antenna of a type and maximum (or lesser) gain approved for the transmitter by Industry Canada. To reduce potential radio interference to other users, the antenna type and its gain should be so chosen that the equivalent isotropically radiated power (e.i.r.p.) is not more than that necessary for successful communication.

Conformément à la réglementation d'Industrie Canada, le présent émetteur radio peut fonctionner avec une antenne d'un type et d'un gain maximal (ou inférieur) approuvé pour l'émetteur par Industrie Canada. Dans le but de réduire les risques de brouillage radioélectrique à l'intention des autres utilisateurs, il faut choisir le type d'antenne et son gain de sorte que la puissance isotrope rayonnée équivalente (p.i.r.e.) ne dépasse pas l'intensité nécessaire à l'établissement d'une communication satisfaisante.

8.2.2 RF exposure

All transmitters regulated by IC must comply with RF exposure requirements listed in RSS-102 - Radio Frequency (RF) Exposure Compliance of Radiocommunication Apparatus (All Frequency Bands). This module is approved for installation into mobile and/or portable host platforms and must not be co-located or operating in conjunction with any other antenna or transmitter except in accordance with Industry Canada's multi-transmitter guidelines. End users must be provided with transmitter operating conditions for satisfying RF Exposure compliance.

8.3 European Union regulatory compliance

Information about regulatory compliance of the European Union for the BMD-300 module is available in the BMD-300 Declaration of Conformity.

8.3.1 Radio Equipment Directive (RED) 2014/53/EU

The BMD-300 module complies with the essential requirements and other relevant provisions of Radio Equipment Directive (RED) 2014/53/EU.

8.3.2 Labeling and user information requirements

The label on the final products which contain the BMD-300 module must follow CE marking requirements. The “R&TTE Compliance Association Technical Guidance Note 01” provides guidance on final product CE marking.

8.4 Japan (MIC)

The BMD-300 module has received type certification and is labeled with its own technical conformity mark and certification number as required to conform to the technical standards regulated by the Ministry of Internal Affairs and Communications (MIC) of Japan pursuant to the Radio Act of Japan. Integration of this module into a final end product does not require additional radio certification provided installation instructions are followed and no modifications of the module are allowed. Additional testing may be required:

- If the host product is subject to electrical appliance safety (for example, powered from an AC mains), the host product may require Product Safety Electrical Appliance and Material (PSE) testing. The integrator should contact their conformance laboratory to determine if this testing is required.
- There is a voluntary Electromagnetic Compatibility (EMC) test for the host product administered by VCCI: http://www.vcci.jp/vcci_e/index.html

The label on the end product which contains a BMD-300 Series module must follow the MIC marking requirements. Labeling requirements for Japan available at the Ministry of Internal Affairs and Communications (MIC) website: <http://www.tele.soumu.go.jp/e/index.htm>.

The BMD-300 module is labeled with its assigned technical conformity mark and certification number. The end product in which this module is being used must have an external label referring to the type certified module inside:

Contains transmitter module with certificate number:

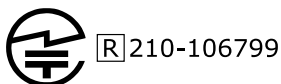

8.5 Australia / New Zealand (RCM)

The BMD-300 has been tested to comply with the AS/NZS 4268:2017, Radio equipment and systems – Short range devices – Limits and methods of measurement. The report may be obtained from your local FAE, and may be used as evidence in obtaining permission to use the Regulatory Compliance Mark (RCM).

Information on registration as a Responsible Party, license and labeling requirements may be found at the following websites:

Australia: <http://www.acma.gov.au/theACMA/radiocommunications-short-range-devices-standard-2004>

New Zealand: <http://www.rsm.govt.nz/compliance>

Only Australian-based and New Zealand-based companies who are registered may be granted permission to use the RCM. An Australian-based or New Zealand-based agent or importer may also register as a Responsible Party to use the RCM on behalf of a company not in Australia or New Zealand.

8.6 South Korea (KCC)

The BMD-300 is certified under Clause 2, Article 58-2 of the Radio Waves Act.

When a product containing the BMD-300 is placed on the South Korean market, the product must be affixed with a label or marking containing the KCC logo and certification number as shown in the following figure. This information must also be included in the product user manuals.

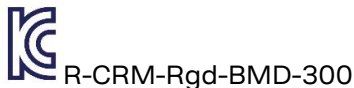

The height of the KCC logo must be at least 5 mm.

8.7 Brazil (ANATEL)

The BMD-300 is evaluated according to: Resolution 680 of 27/06/2017, Act 14448 of 04/12/2017, Certificate number: 00820-21-05903.

The end products that contain these modules must list the ANATEL number from the modular approval. The number can go on the end product label, manual, box or software, with the following phrase:

Contains ANATEL approved module # 00820-21-05903

8.8 Mexico (IFETEL)

The end products that contain these modules must list the IFETEL number from the modular approval. The number can go on the end product label, manual, box or software, with the following phrase:

Este equipo contiene el módulo BMD-300 con Número IFETEL: NYCE/CT/0146/17/TS

- or -

Este equipo contiene el módulo con IFT #: NYCE/CT/0146/17/TS

8.9 Bluetooth qualification

The Bluetooth SIG maintains the Bluetooth Specification, and ensures that products are properly tested and comply with the Bluetooth license agreements. Companies that list products with the Bluetooth SIG are required to be members of the SIG and submit the listed fees. Refer to this link for details: <https://www.bluetooth.com/develop-with-bluetooth/qualification-listing>

The BMD-300 Bluetooth Low Energy module based on the Nordic Semiconductor nRF52832 is listed as a “Tested Component”, with Qualified Design ID 101625. This allows an end-product based on a BMD-300 module to inherit the component listings without the need to run through all of the tests again. The end-product will often inherit several QDIDs, and are identified on a “Declaration of Compliance”.

The BMD-300 primarily utilizes the S132 SoftDevice.

9 Environmental

9.1 RoHS

The BMD-300 is in compliance with Directive 2011/65/EU, 2015/863/EU of the European Parliament and the Council on the restriction of the use of certain hazardous substances in electrical and electronic equipment. The RoHS declaration is available in the BMD-300 EU Declaration of Conformity [2].

9.2 REACH

The BMD-300 does not contain the [SVHC \(Substance of Very High Concern\)](#), as defined by Directive EC/1907/2006 Article according to REACH Annex XVII.

9.3 California proposition 65 (P65)

This product can expose you to Nickel (metallic), which is known to the State of California to cause cancer. For more information go to www.P65Warnings.ca.gov. Warnings are not required where the listed chemical is inaccessible to the average user of the end product.

10 Product handling

10.1 Packaging

10.1.1 BMD-300-A-R-00 reel packaging

Modules are packaged on 330 mm reels loaded with 1000 modules. Each reel is placed in an antistatic bag with a desiccant pack and humidity card and placed in a 340x350x65 mm box. An antistatic warning and reel label are adhered to the outside of the bag.

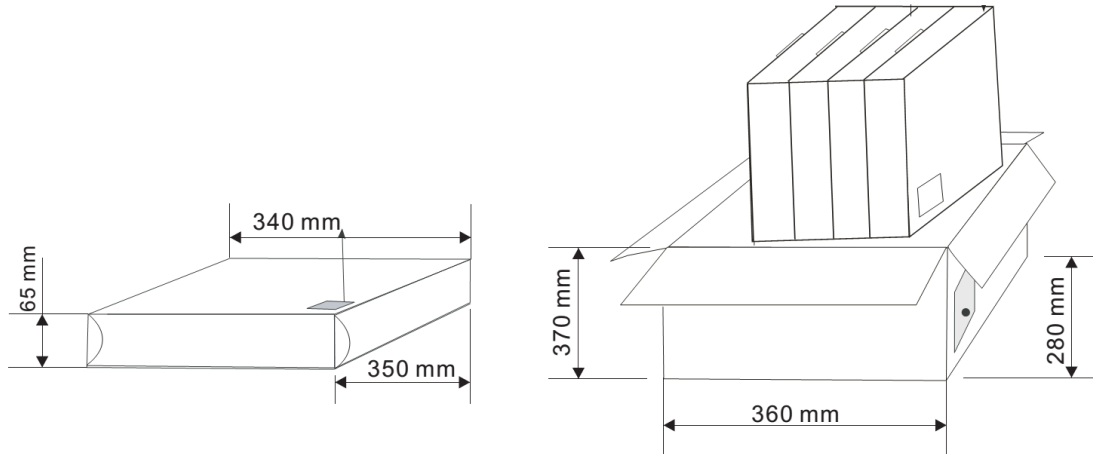

Figure 13: Reel cartons used for type number BMD-300-A-R-00

10.1.2 BMD-300-A-R-10 and BMD-300-A-R-20 reel packaging

Modules are packaged on 330 mm reels loaded with 1000 modules. Each reel is placed in an antistatic bag with a desiccant pack and humidity card and placed in a 370x355x56 mm box. See the u-blox Package Information Guide [1] for full specifications on reel dimensions, box sizes and shipping label content. BMD-300-A-R-10 and BMD-300-A-R-20 modules use u-blox reel type A3.

10.1.3 BMD-300-A-R-00 carrier tape dimensions

The BMD-300-A-R-00 modules are placed in the carrier tape specified in Figure 14. The module antenna is facing the tape sprocket holes.

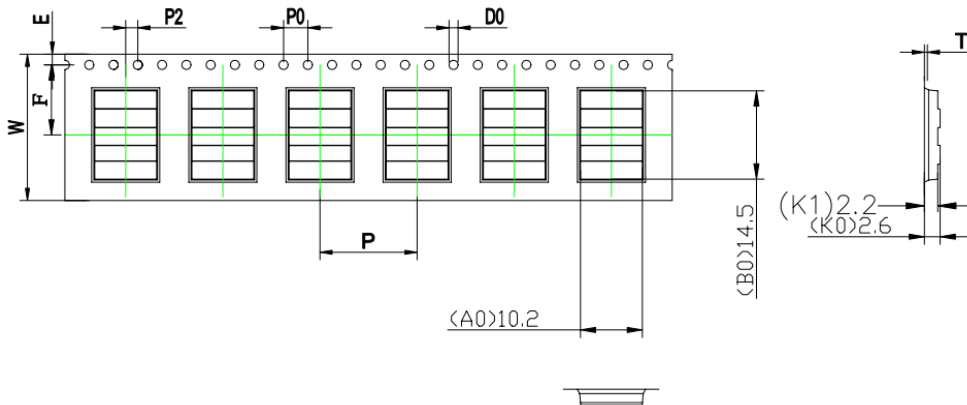

ITEM	W	A ₀	B ₀	K ₀	K ₁	P	F	E	D ₀	D ₁	P ₀	P ₂	T
DIM	24.0 ^{+0.30} _{-0.30}	10.2 ^{+0.10} _{-0.10}	14.5 ^{+0.10} _{-0.10}	2.6 ^{+0.10} _{-0.10}	2.2 ^{+0.00} _{-0.00}	16.0 ^{+0.10} _{-0.10}	11.5 ^{+0.10} _{-0.10}	1.75 ^{+0.10} _{-0.10}	1.50 ^{+0.10} _{-0.00}	0.00 ^{+0.10} _{-0.00}	4.00 ^{+0.10} _{-0.10}	2.00 ^{+0.10} _{-0.10}	0.30 ^{+0.05} _{-0.05}
ALTERNATE													

Figure 14: BMD-300-A-R-00 carrier tape dimensions

10.1.4 BMD-300-A-R-10 and BMD-300-A-R-20 carrier tape dimensions

The BMD-300-A-R-10 and BMD-300-A-R-20 modules are placed in the carrier tape specified in Figure 15. The module antenna is facing the tape sprocket holes.

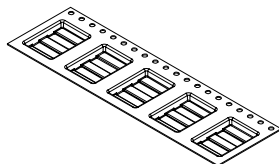
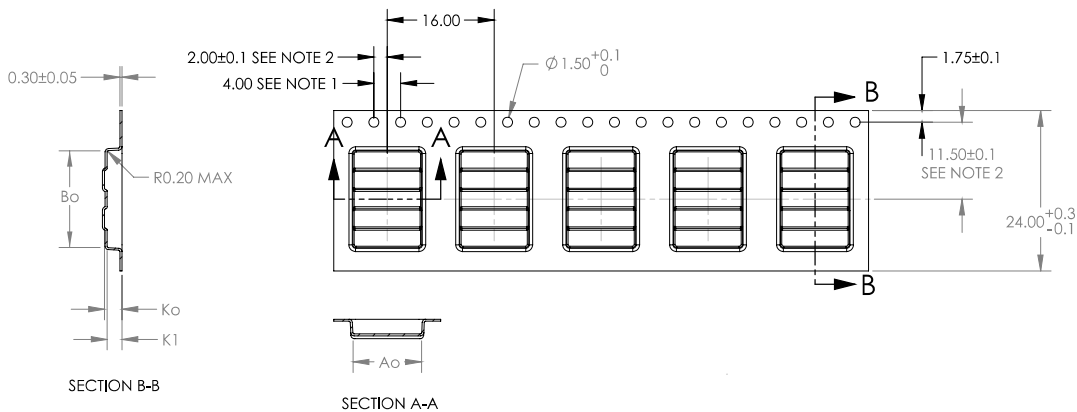

DIM	±
A ₀	0.1
B ₀	0.1
K ₀	0.1
K ₁	0.1

NOTES:

1. 10 SPROCKET HOLE PITCH CUMULATIVE TOLERANCE ± 0.2
2. POCKET POSITION RELATIVE TO SPROCKET HOLE MEASURED AS TRUE POSITION OF POCKET, NOT POCKET HOLE.
3. A₀ AND B₀ ARE MEASURED ON A PLANE AT A DISTANCE "R" ABOVE THE BOTTOM OF THE POCKET.

Figure 15: BMD-300-A-R-10 and BMD-300-A-R-20 carrier tape dimensions

10.2 Moisture sensitivity level

The BMD-300 Series is rated for MSL 3, 168-hour floor life after opening.

10.3 Reflow soldering

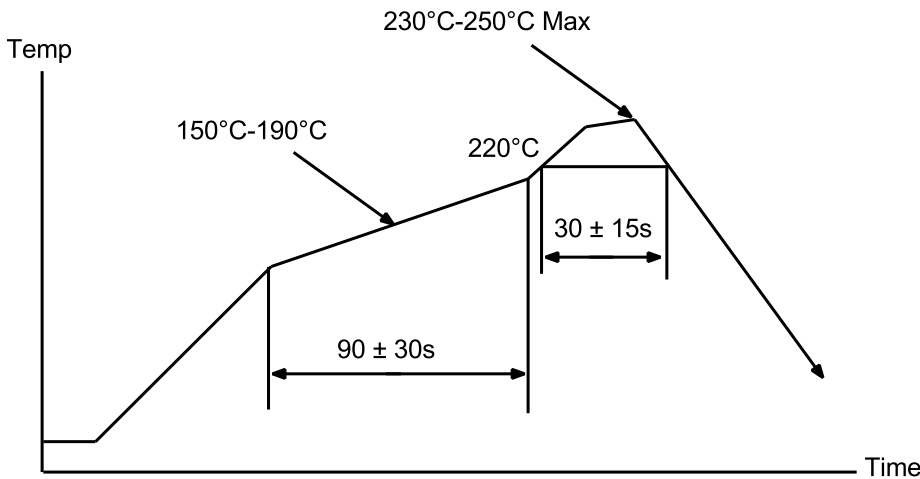

Figure 16: Reflow Profile for Lead Free Solder

10.4 ESD precautions

- ⚠ The BMD-300 module contains highly sensitive electronic circuitry and is an Electrostatic Sensitive Device (ESD). Handling the BMD-300 module without proper ESD protection may destroy or damage them permanently.

Proper ESD handling and packaging procedures must be applied throughout the processing, handling and operation of any application that incorporates the BMD-300 module. Failure to observe these recommendations can result in severe damage to the device.

11 Ordering information

Ordering Code	Product
BMD-300-A-R	BMD-300 module, Rev A, Tape & Reel, 1000-piece multiples
BMD-300-Eval	BMD-300 Evaluation Kit w/ SEGGER J-Link-OB debug probe

Table 12: Product ordering codes

12 Life support and other high-risk warnings

This product is not designed nor intended for use in a life support device or system, nor for use in other fault-intolerant, hazardous or other environments requiring fail-safe performance, such as any application in which the failure or malfunction of the product could lead directly or indirectly to death, bodily injury, or physical or property damage (collectively, “High-Risk Environments”).

 u-blox expressly disclaims any express or implied warranty of fitness for use in high-risk environments.

The customer using this product in a High-Risk Environment agrees to indemnify and defend u-blox from and against any claims and damages arising out of such use.

Related documents

- [1] u-blox Package Information Guide, [UBX-14001652](#)
- [2] u-blox BMD-300 EU Declaration of Conformity, [UBX-20002607](#)
- [3] Nordic Semiconductor, [nRF52832 Product Specification](#)
- [4] Nordic Semiconductor, [nRF Connect SDK](#)
- [5] Nordic Semiconductor, [nRF5 Software Development Kit](#)
- [6] Nordic Semiconductor, [nRF52832 errata 138](#)

 For product change notifications and regular updates of u-blox documentation, register on our website, www.u-blox.com

Revision history

Revision	Date	Name	Comments
0.8	06-Nov-2015		Initial preliminary release.
0.8.1	10-Nov-2015		Updated Table 5, Figure 5, Section 7.5. Corrected antenna references.
0.8.2	11-Nov-2015		Updated Figure 1.
0.8.3	20-Nov-2015		Updated current ratings from nRF52832 OPC v0.6.3. Corrected Table 3.
0.9	17-Mar-2016		Added BMD-301, GPIO notes, MSL, updated certifications, updated electrical specifications
0.9.4	23-Mar-2016		Added BMD-301 antennas
1.0	04-May-2016		Production Release; removed pending for FCC, Japan (MIC), & Bluetooth
1.1	20-May-2016		Removed pending for IC, MIC (BMD-301)
1.2	03-Jun-2016		Added Factory Firmware Version AB information
1.3	06-Jun-2016		Updated Module Programming and Read-Back Protection section
1.4	07-Jul-2016		Added preliminary information for the BMD-350
1.5	28-Jul-2016		Added RigDFU and BMDware pin numbers, corrected nRF52832 PS link
1.6	10-Aug-2016		Corrected RESET pin number on BMD-350
1.7	10-Nov-2016		Updated layout drawings, added more BMD-350 data + certs
1.8	02-Dec-2016		Added BMD-350 Japan certificate number
1.9	10-Aug-2017		Added RED for BMD-300, BMD-301, BMD-350; BT DID for BMD-350, Factory Firmware AD
1.10	29-Sep-2017		Added Bluetooth 5 QDIDs, Factory Firmware AE
1.11	17-Apr-2018		Added antenna gain in section 5
1.2	08-Oct-2018		Added BMDware, RigDFU, Rigablue notice in Section 8. Removed BMDware and RigDFU pin-out sections 6.3 and 6.4. Called out BMD-300/301/350 in title rather than "Series"
2.0	01-Feb-2019		Updated to new format; BMD-300, BMD-301, and BMD-350 are now in separate datasheets; Updated Life Support and other High-Risk Use Warning
2.1	28-Feb-2019		Added Bluetooth mesh to Features and Quick Specifications. Updated links to Nordic Semiconductor web information
R22	08-Nov-2019	brec	Document converted from Rigado to u-blox BMD-300 data sheet.
R23	10-Jan-2020	brec	Edits for consistency with other BMD-3 modules; Removed outer container label images (now in UBX-14001652).
R24	13-Feb-2020	brec	Added type number BMD-300-A-R-10; Added u-blox logo to Figure 3 to show orientation of label; Added label information for new type number in section 5.3; Added ESD precautions in section 10.4; Changed images to be u-blox branded; Added packaging specification for type number BMD-300-A-R-10 in section 10.1.
R25	31-Mar-2020	brec	Updated product photos

Revision	Date	Name	Comments
R26	31-Mar-2021	brec	Added reference to Nordic Semiconductor errata 138 for nRF52832, added clarification of firmware version encoding in Table 11, updated ANATEL certificate number
R27	19-Jul-2021	brec	Added type number BMD-300-A-R-20, added nRF Connect SDK references

Contact

For complete contact information, visit us at www.u-blox.com.

u-blox Offices

North, Central and South America

u-blox America, Inc.

Phone: +1 703 483 3180
E-mail: info_us@u-blox.com

Regional Office West Coast:

Phone: +1 408 573 3640
E-mail: info_us@u-blox.com

Technical Support:

Phone: +1 703 483 3185
E-mail: support@u-blox.com

Headquarters

Europe, Middle East, Africa

u-blox AG

Phone: +41 44 722 74 44
E-mail: info@u-blox.com
Support: support@u-blox.com

Asia, Australia, Pacific

u-blox Singapore Pte. Ltd.

Phone: +65 6734 3811
E-mail: info_ap@u-blox.com
Support: support_ap@u-blox.com

Regional Office Australia:

Phone: +61 3 9566 7255
E-mail: info_au@u-blox.com
Support: support_ap@u-blox.com

Regional Office China (Beijing):

Phone: +86 10 68 133 545
E-mail: info_cn@u-blox.com
Support: support_cn@u-blox.com

Regional Office China (Chongqing):

Phone: +86 23 6815 1588
E-mail: info_cn@u-blox.com
Support: support_cn@u-blox.com

Regional Office China (Shanghai):

Phone: +86 21 6090 4832
E-mail: info_cn@u-blox.com
Support: support_cn@u-blox.com

Regional Office China (Shenzhen):

Phone: +86 755 8627 1083
E-mail: info_cn@u-blox.com
Support: support_cn@u-blox.com

Regional Office India:

Phone: +91 80 405 092 00
E-mail: info_in@u-blox.com
Support: support_in@u-blox.com

Regional Office Japan (Osaka):

Phone: +81 6 6941 3660
E-mail: info_jp@u-blox.com
Support: support_jp@u-blox.com

Regional Office Japan (Tokyo):

Phone: +81 3 5775 3850
E-mail: info_jp@u-blox.com
Support: support_jp@u-blox.com

Regional Office Korea:

Phone: +82 2 542 0861
E-mail: info_kr@u-blox.com
Support: support_kr@u-blox.com

Regional Office Taiwan:

Phone: +886 2 2657 1090
E-mail: info_tw@u-blox.com
Support: support_tw@u-blox.com

X-ON Electronics

Largest Supplier of Electrical and Electronic Components

Click to view similar products for [Bluetooth Modules - 802.15.1 category](#):

Click to view products by [Rigado manufacturer](#):

Other Similar products are found below :

[A2541R24A10GM](#) [CYBLE-212023-10](#) [BM78SPP05NC2-0002AA](#) [BM78SPP05MC2-0002AA](#) [CYW20732S](#) [968EMB0019](#) [E73-2G4M08S1CX](#) [TB-03F-AT_Mesh](#) [TB-04](#) [TB-04--AT_Mesh](#) [BT3L\(jibu\)](#) [BT5S\(xoft\)](#) [BT5S\(4k43\)](#) [BT5S\(jcyv\)](#) [1327](#) [RN42HID-I/RM](#) [BM70BLE01FC2-0B03AA](#) [ACN52832](#) [A2541E24A10GM](#) [RN42-I/RM630](#) [MOTG-BLUETOOTH](#) [ABBTM-2.4GHz-52-T](#) [ABBTM-2.4GHz-T](#) [ABBTM-2.4GHz-T2](#) [ACN52840](#) [AFERO-BL24-01](#) [BLED112](#) [BM62SPKS1MC2-0001AA](#) [BM78SPPS5MC2-0002AA](#) [PX0880/1](#) [BM833F](#) [BT680F](#) [PBA31309V1.00](#) [S LK64](#) [ATSAMB11-MR510CA](#) [BM20SPKS1NBC-0001AA](#) [BM23SPKS1NB9-0B02AA](#) [BM70BLE01FC2-0B04AA](#) [BM70BLES1FC2-0B04AA](#) [BM77SPP03MC2-0008AA](#) [BM77SPPS3MC2-0007AA](#) [BM78SPPS5NC2-0002AA](#) [DM164146](#) [RN42-I/RM615](#) [RN42N-I/RM](#) [RN42NU-IRM](#) [RN42XVP-I/RM](#) [RN4678-V/RM113](#) [RN4871U-V/RM118](#) [ENW-89820A3KF](#) [ENW-89846A1KF](#)