

POWER DISTRIBUTION

RiLine busbar systems

Overview	281
RiLine Compact busbar system	283
Mini-PLS busbar system (40 mm)	294
RiLine busbar system (60 mm)	299

VX25 Ri4Power

Modular enclosures	132
Installation accessories for modular front design	925
Fuse-switch-disconnector enclosures	134

Overview	361
Ri4Power busbar system (185 mm)	362
Busbar systems (100/185/150 mm)	388
Flat-PLS busbar system	394
Maxi-PLS busbar system	401
Connection components	406
Cover systems	408
Compartment configuration Form 1-4	410
Fuse-switch disconnector section	415
VX25 Ri4Power accessories	417

Distribution enclosures

Overview	419
Distribution enclosures	135
Mounting kits	420
Installation modules	421
ISV accessories	428

Power distribution software

VX25 Power Engineering	446
------------------------------	-----

Power distribution

Rittal – The System.

Faster – better – everywhere.

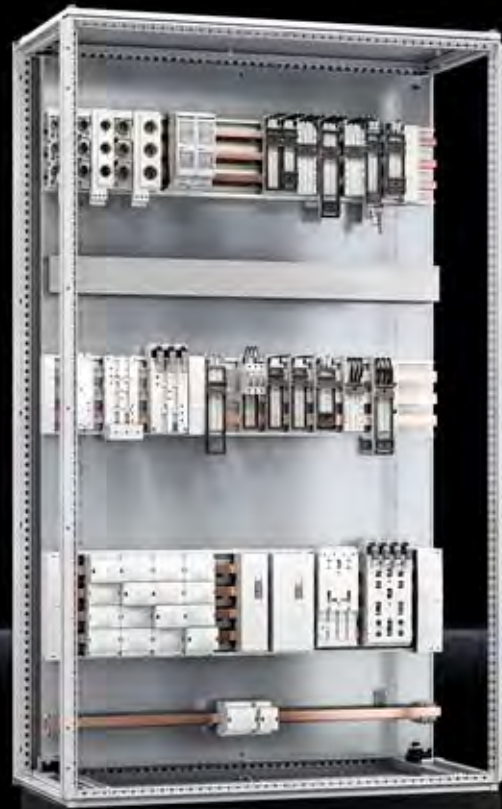

RiLine busbar systems				
	<p>The tried-and-trusted, super-flexible power distribution systems for individual requirements. From small power distributors, to individual switchgear and controlgear, through to heavy-current power distributors for infrastructure and industry applications. Simple, secure assembly plus user-friendly planning with design verification are the distinguishing features of these systems.</p>			
Busbar system	RiLine Compact	Mini-PLS	RiLine PLS/flat copper bars	
Bar centre distance mm	–	40	60	
Rated current A up to	125	250	800, 1600	
Product characteristics	<ul style="list-style-type: none"> ■ Contact hazard-protected board with integral busbars for the safe accommodation and contacting of components ■ The board and all components are simply top-mounted; no tools required ■ Suitable for AC and DC applications 	<ul style="list-style-type: none"> ■ Space-saving design with full-surface top-mounting of the busbar supports and bar connector elements ■ Simple component installation via plug and lock action from the front ■ Optimum contact hazard protection with all-round encapsulation 	<ul style="list-style-type: none"> ■ Thanks to the special styling of the PLS special busbars, top-mounting with components in the support area is not a problem ■ Optimum contact hazard protection with all-round encapsulation ■ Suitable for AC and DC applications 	
From page	282	294	300	



VX25 Ri4Power		
<p>The tested complete solution – Enclosure and bar system. Mutual interference between electrical equipment in low-voltage switchgear systems has already been tested to IEC 61 439 and confirmed with a design verification.</p>	<p>Modular system for low-voltage switchgear with design verification to IEC 61 439-1/-2 and DIN EN 61 439-1/-2 plus power distributors and structured system solutions for switchgear with 1-4b Form separation.</p>	<p>ISV distribution enclosures for standard-compliant power supply in buildings and industry. Flexible configuration with practical power distribution modules.</p>
Flat copper busbars	Flat copper busbars	Flat copper busbars
185	60, 70, 80, 185	60, 100, 185
2100	6300	–
<ul style="list-style-type: none"> ■ Supports top-mounting of the busbar supports with components on the cover system pitch pattern ■ Integral busbar shielding in the cover section to prevent accidental arcing ■ Top-mounting of the cover section and quick retrofitting of components without removing the cover section 	<ul style="list-style-type: none"> ■ Tested system solutions to the internationally valid standard IEC 61 439-1 and simple creation of the design verification ■ High levels of short-circuit withstand strength up to I_{CW} 100 kA for 1 sec./I_{pk} 220 kA ■ Tested accidental arcing protection to IEC 61 641 	<ul style="list-style-type: none"> ■ Distribution enclosures as wall-mounted and free-standing enclosures for individual population with modular elements
362	391	419

Rittal – The System.

Faster – better – everywhere.



Busbar systems

RiLine Compact busbar system

Board	284
Connection adaptors	285
Component adaptors	286
Component supports	288
Circuit-breaker component adaptors	289
NH fuse-switch disconnectors	290
Motor controller	291
Power pack	292
Accessories	293

Mini-PLS busbar system (40 mm)

Busbar supports	294
Special busbars E-Cu	294
Contact hazard protection	294
Busbar connection adaptors	294
Bus-mounting fuse base	295
NH fuse-switch disconnectors, size 000	295
Component adaptors	296

RiLine busbar system (60 mm)

Flat copper bar system	300
PLS busbar system	302
Connection adaptors	304
Connection adaptor expansion set	306
OM adaptors with connection cables	307
OM adaptors with spring terminals	310
OM adaptors with plug-in cable outlet	312
OM supports	313
Circuit-breaker component adaptors, 3-pole	314
Circuit-breaker component adaptors, 4-pole	317
Switchgear assignment	319
Bus-mounting fuse base	323
NH fuse-switch disconnectors, size 000	325
NH fuse-switch disconnectors, size 00 to 3	327
– With electronic fuse monitoring	329
– With electromechanical fuse monitoring	331
Smart Monitoring System	
– NH measurement module	333
– Display/power pack	334
NH slimline fuse-switch disconnectors, size 00	335
– With electronic fuse monitoring	336
Fuse holders	338
RiLine accessories	340



RiLine Compact – Power distribution in a confined space

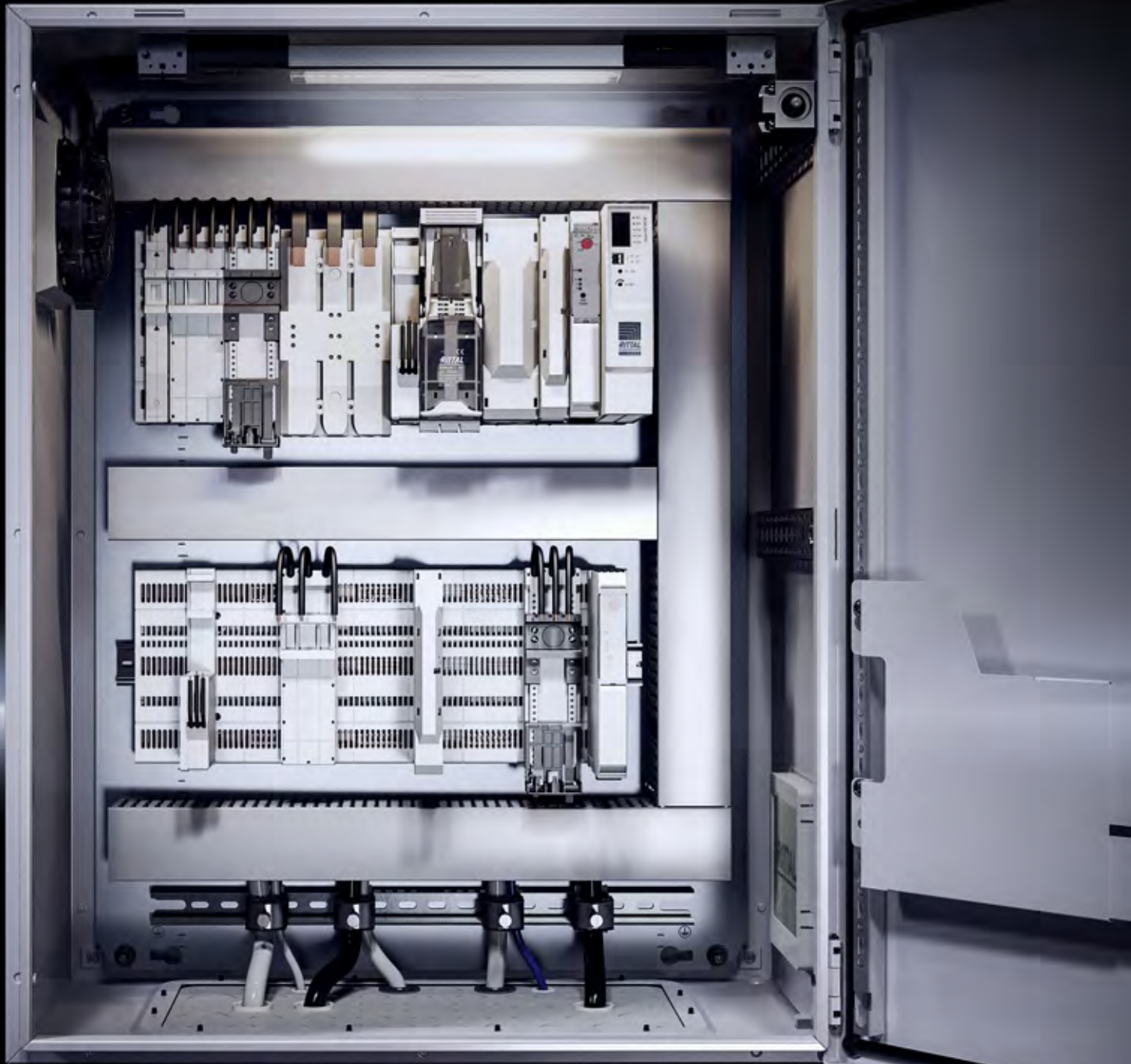

Tool-free installation made easy

- The board with integral circuit board conductors and all components are simply top-mounted; no tools required.
- Attaching the components simultaneously ensures a secure electrical connection to the all-round shock-hazard-protected board.
- The contact pitch pattern of the RiLine Compact system allows the assemblies to be positioned anywhere, in line with requirements.

Safe adaptor connection

- The RiLine Compact system adaptors support fast connection of cables and devices.
- The screw-free connection technology in the adaptor means that conductors are quickly connected, and the contact point itself is completely maintenance-free.
- The component adaptors with preassembled connection cables satisfy the special requirements of IEC 61 439 and UL.

Space-saving installation of electronic components

- The compact power supply unit provides a regulated control voltage of 24 V DC. The integral push-in terminal allows simple, fast connection of the conductors.
- The motor controller with electronic overload protection has an exceptionally space-saving design and takes up 50% less space than a conventionally wired motor controller. The hybrid technology creates a low-loss motor controller which is particularly gentle on the switching contacts. This helps to extend the service life.

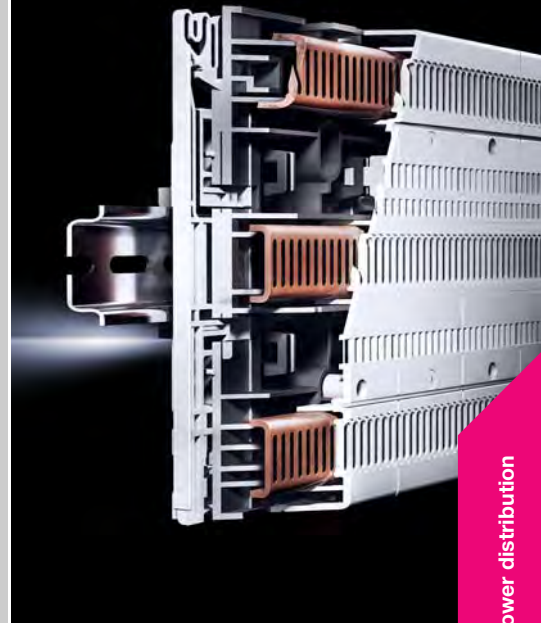

Power distribution



Board

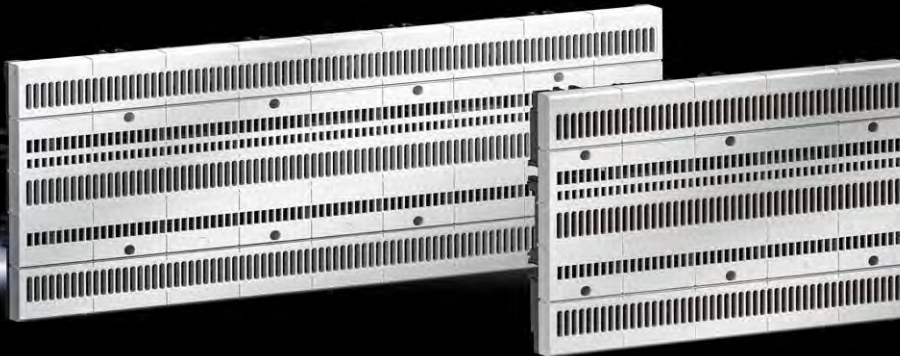

Connection adaptors Page 285 **Component adaptors** Page 286 **NH fuse-switch disconnectors** Page 290 **Motor controller/power pack** Page 291

Functions:

- Shock-hazard-protected busbar board for the safe accommodation and contacting of components, thanks to simple plug-in mounting
- Pre-punched pitch units in the board allow secure, fast positioning of components
- Reduces wiring work by contacting directly onto the board
- For snap-on mounting onto 35 x 7.5/15 mm busbars or for direct attachment to the mounting plate

Material:

- Polyamide
- Polycarbonate
- E-Cu
- Fire protection corresponding to UL 94-V0

Colour:

- RAL 7035

Protection category IP to IEC 60 529:

- IP 20

Supply includes:

- Integral busbars

Note:

- The technical data may vary for UL applications

Standards:

- UL 508
- IEC 61 439

Approvals:

- UL

RiLine Compact, 3-pole

	Packs of	125	125	Page
Rated current max. A				
Rated operating voltage V		690 (AC) 600 (DC)	690 (AC) 600 (DC)	
Number of poles		3-pole	3-pole	
Max. pitch units @ 45 mm		5	9	
Width mm		225	405	
Height mm		160	160	
Depth mm		45.1	45.1	
Model No.	1 pc(s).	9635.000	9635.010	

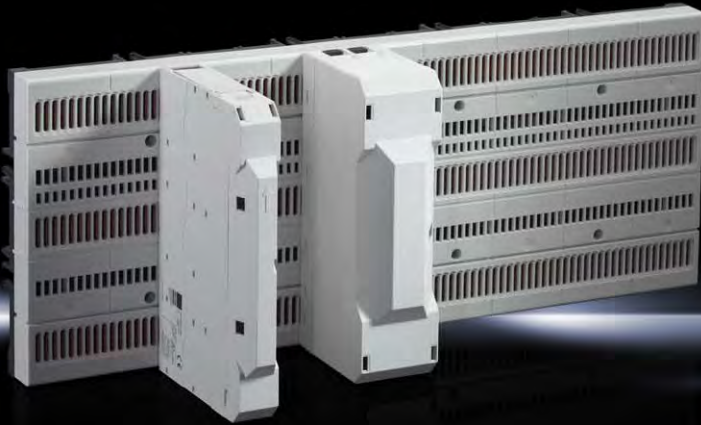

Board Page 284 **Component adaptors** Page 286 **NH fuse-switch disconnectors** Page 290 **Motor controller/power pack** Page 291

Functions:

- To supply power to the board

Material:

- Polyamide
- Fire protection corresponding to UL 94-V0

Colour:

- RAL 7035

Note:

- The technical data may vary for UL applications

Approvals:

- UL

Rated current max. 80 – 125 A, 3-pole

Rated current max. A	Packs of	80	125	Page
Rated operating voltage V, ~		690 (AC), 3~ 600 (DC), 3~	690 (AC), 3~ 600 (DC), 3~	
Number of poles		3-pole	3-pole	
Cable outlet		Top/bottom	Top/bottom	
Type of connection		Spring terminal	Box terminal	
Connection of round conductors, fine wire without wire end ferrule mm ²		1.5 - 16	6 - 50	
Connection of round conductors, fine wire with wire end ferrule mm ²		1.5 - 16	6 - 50	
Connection of round conductors, multi-wire mm ²		1.5 - 16	6 - 50	
Connection of round conductors, single-wire mm ²		1.5 - 10	6 - 50	
Connection of round conductors		AWG 6 - 16	AWG 1 - 10	
When using fine-wire round conductors 16 mm ² with wire end ferrule, we recommend the following crimping tools: Rittal 4054.004, Weidmüller PZ 16, Phoenix Contact Crimpfox 25R		■	-	
Can be used as a central infeed or as a longitudinal connector for two bayed boards		-	■	
Width mm		22.5	45	
Height mm		160	160	
Depth mm		115.5	92.5	
Model No.	4 pc(s).	9635.200	9635.210	

Component adaptors



Board Page 284 **Connection adaptors** Page 285 **NH fuse-switch disconnectors** Page 290 **Motor controller/power pack** Page 291

Functions:

- For mechanical attachment and direct contacting of electrical equipment on the board

Material:

- Polyamide
- Fire protection corresponding to UL 94-V0

Colour:

- RAL 7035

Note:

- Different adaptor versions are required depending on the preferred phase connection
- The technical data may vary for UL applications

Approvals:

- UL

Rated current max. 16 – 63 A, 1-pole

Design	Packs of	L1	L2	L3	L1	L2	L3	Page
Rated current max. A		16	16	16	63	63	63	
Rated operating voltage V, ~		690 (AC), 1~	690 (AC), 1~	690 (AC), 1~	690 (AC), 1~	690 (AC), 1~	690 (AC), 1~	
Number of poles		Single-pole	Single-pole	Single-pole	Single-pole	Single-pole	Single-pole	
Connection cables, Design		AWG 14	AWG 14	AWG 14	AWG 8	AWG 8	AWG 8	
Connection cables, Length mm		100	100	100	100	100	100	
Support rails Qty/height mm		1 / 10	1 / 10	1 / 10	1 / 10	1 / 10	1 / 10	
Support rail version		static	static	static	static	static	static	
Width mm		18	18	18	18	18	18	
Height mm		160	160	160	160	160	160	
Depth mm		35	35	35	35	35	35	
Model No.	6 pc(s).	9635.371	9635.372	9635.373	9635.381	9635.382	9635.383	

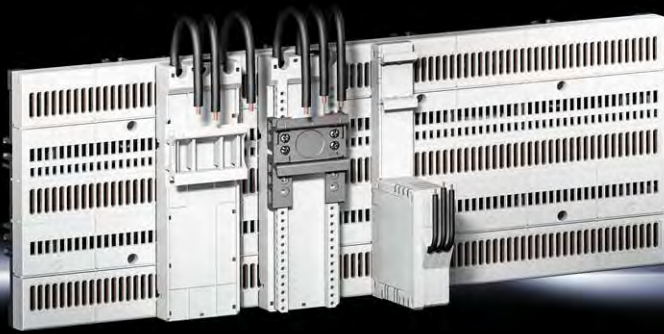

Board Page 284 **Connection adaptors** Page 285 **NH fuse-switch disconnectors** Page 290 **Motor controller/power pack** Page 291

Functions:

- For mechanical attachment and direct contacting of electrical equipment on the board

Material:

- Polyamide
- Fire protection corresponding to UL 94-V0

Colour:

- RAL 7035

Note:

- The technical data may vary for UL applications

Approvals:

- UL

Rated current max. 16 – 45 A, 3-pole

Design		With integral fuse holder	Basic	Basic	Comfort	Comfort	Comfort	Comfort	Page
Fuse type (class)		CC	-	-	-	-	-	-	
Rated current max. A		16	16	32	16	25	32	45	
Rated operating voltage V, ~		690 (AC), 3~600 (DC), 3~	690 (AC), 3~600 (DC), 3~	690 (AC), 3~600 (DC), 3~	690 (AC), 3~600 (DC), 3~	690 (AC), 3~600 (DC), 3~	690 (AC), 3~600 (DC), 3~	690 (AC), 3~600 (DC), 3~	
Number of poles		3-pole	3-pole	3-pole	3-pole	3-pole	3-pole	3-pole	
Fuse size mm		10 x 38	-	-	-	-	-	-	
Connection cables, Design		AWG 14	AWG 14	AWG 10	AWG 14	AWG 12	AWG 10	AWG 8	
Connection cables, Length mm		125	120	100	160	100	160	100	
Support rails Qty/height mm		1 / 10	1 / 10	1 / 10	1 / 10	1 / 10	1 / 10	1 / 10	
Support rail version		static	static	static	adjustable	adjustable	adjustable	adjustable	
Width mm		22.5	45	45	45	45	45	45	
Height mm		160	160	160	160	160	160	160	
Depth mm		80	34.5	34.5	34.5	34.5	34.5	34.5	
Model No.		9635.300	9635.310	9635.320	9635.330	9635.340	9635.350	9635.360	
	Packs of	1 pc(s).	4 pc(s).	4 pc(s).	4 pc(s).	4 pc(s).	4 pc(s).	4 pc(s).	

Accessories

Support rail	10 pc(s).	-	-	-	9635.600	9635.600	9635.600	9635.600	293
Positioner		-	-	-	see page	see page	see page	see page	293
Extension module	8 pc(s).	-	-	-	9635.630	9635.630	9635.630	9635.630	293
Extension kit	4 pc(s).	-	-	-	9635.640	9635.640	9635.640	9635.640	293

Component support

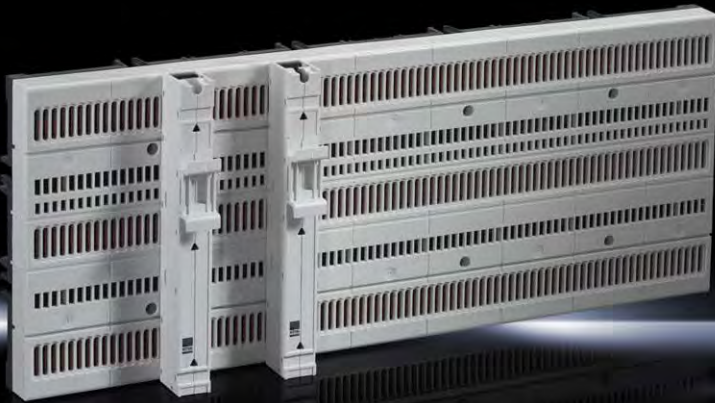

Board Page 284 **Connection adaptors** Page 285 **NH fuse-switch disconnectors** Page 290 **Motor controller/power pack** Page 291

Functions:

- For extending the mounting options on the board when using wide equipment

Material:

- Polyamide
- Fire protection corresponding to UL 94-V0

Colour:

- RAL 7035

Approvals:

- UL

without contact system

Support rails Qty/height mm	Packs of	1 / 10	Page
Support rail version		static	
Width mm		18	
Height mm		160	
Depth mm		34.5	
Model No.	6 pc(s).	9635.390	

Circuit-breaker component adaptors



Board Page 284 Connection adaptors Page 285 NH fuse-switch disconnectors Page 290 Motor controller/power pack Page 291

Functions:

- For mechanical attachment and direct contacting of circuit-breakers on the board
- Circuit-breaker is fitted using variably adjustable fixing points (M4)

Material:

- Polyamide
- Fire protection corresponding to UL 94-V0

Colour:

- RAL 7035

Note:

- Consider the mounting distance of the circuit-breaker when selecting the circuit-breaker component adaptor
- Depending on the circuit-breaker used, there may be a reduction in output
- The technical data may vary for UL applications

Approvals:

- UL

Rated current max. 160 A, 3-pole

Rated current max. A	Packs of	160	160	Page
Rated operating voltage V, ~		690 (AC), 3~ 600 (DC), 3~	690 (AC), 3~ 600 (DC), 3~	
Number of poles		3-pole	3-pole	
Cable outlet		Top/bottom	Top/bottom	
For switchgear make (model)		ABB (XT1) Allen Bradley (140G-G) Siemens (3VA10, 3VA11, 3VA51)	ABB (XT2) Allen Bradley (140G-H) Eaton (NZM1) Schneider Electric (NSXm)	
Mounting distance mm		25	30	
Width mm		90	90	
Height mm		160	160	
Depth mm		45	45	
Model No.	1 pc(s).	9635.100	9635.110	

NH fuse-switch disconnectors



Board Page 284 **Connection adaptors** Page 285 **Component adaptors** Page 286 **Motor controller/power pack** Page 291

Functions:

- To protect connected equipment
- Integral test holes provide measurement access to the contact parts of the fuse inserts
- For cable outlet at the top, the NH fuse-switch disconnector must be mounted on the board rotated through 180°

Material:

- Polyamide
- Fire protection corresponding to UL 94-V0
- Contact tracks: Silver-plated hard copper

Colour:

- RAL 7035

Basis of test:

- IEC/DIN EN 60 947-3

Size 000

Size	Packs of	000	Page
Rated operating current max. A		125	
Rated operating voltage V, ~		690 (AC), 3~ 440 (DC), 3~	
Number of poles		3-pole	
Cable outlet		Top/bottom	
Type of connection		Box terminal	
Connection of round conductors mm ²		2.5 - 50	
Clamping area for laminated copper bars (W x H) mm		10 x 10	
Width mm		49.5	
Height mm		174.5	
Depth mm		96	
Model No.	1 pc(s).	9635.700	

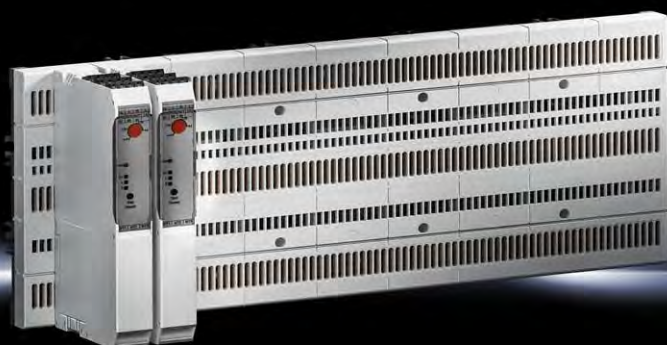

Board Page 284 Connection adaptors Page 285 Component adaptors Page 286 NH fuse-switch disconnectors Page 290

Functions:

- For controlling motors as direct or reversing starters with integral over-ride protection
- The hybrid technology used facilitates frequent switching by semi-conductors with zero wear
- During operation, mechanical contacts ensure a low heat loss
- Space-saving configuration thanks to the minimal build width

Material:

- Polyamide
- Fire protection corresponding to UL 94-V0

Colour:

- RAL 7035

Note:

- The technical data may vary for UL applications

Rated current max. 0.6 – 9 A, 3-pole

Rated current max. A	Packs of	0.6	2.4	3	9	9	Page
Rated operating voltage V, ~, Hz		500 (AC), 3~, 50/60	500 (AC), 3~, 50/60	500 (AC), 3~, 50/60	500 (AC), 3~, 50/60	500 (AC), 3~, 50/60	
Heat loss max. W		2.8	5.5	5.5	12	12	
Number of poles		3-pole	3-pole	3-pole	3-pole	3-pole	
Fuse size mm		10 x 38	10 x 38	10 x 38	10 x 38	10 x 38	
Connection of round conductors mm ²		0.14 - 2.5	0.14 - 2.5	0.14 - 2.5	0.14 - 2.5	0.14 - 2.5	
Safety integrity level (SIL) to IEC 61 508 - safe switch-off		-	-	3	-	3	
Safety integrity level (SIL) to IEC 61 508 - motor protection		-	-	2	-	2	
Adjustable current monitoring A		0.075 - 0.6	0.18 - 2.4	0.18 - 3	1.5 - 9	1.5 - 9	
Width mm		22.5	22.5	22.5	22.5	22.5	
Height mm		160	160	160	160	160	
Depth mm		114	114	114	114	114	
Approvals		UL	UL	-	UL	-	
Model No.	1 pc(s).	9635.400	9635.410	9635.415	9635.420	9635.425	

Power pack



Board Page 284 **Connection adaptors** Page 285 **Component adaptors** Page 286 **NH fuse-switch disconnectors** Page 290

Functions:

- 24 V DC control voltage supply
- Integral push-in terminal for tool-free connection of the output
- Supports parallel switching for increased output or for redundancy
- Fast commissioning, thanks to tool-free installation and automatic contacting of the power pack

Material:

- Plastic

Colour:

- RAL 7035

Protection category IP to

IEC 60 529:

- IP 20

Protection class:

- II (in the closed enclosure)

Standards:

- EN 61 000-6-2
- IEC 61 010-1 (SELV)

Directives:

- EMC Directive 2014/30/EU
- Low Voltage Directive 2014/35/EU

Approvals:

- UL

Rated operating voltage V, ~, Hz	Packs of	400, 2~, 50/60 400, 3~, 50/60 500, 2~, 50/60 500, 3~, 50/60	Page
Output voltage V (DC)		24	
Output current (max.) A		5	
Connection of round conductors mm ²		0.2 - 4	
Width mm		36	
Height mm		160	
Depth mm		159	
Operating temperature range		-25 °C...+70 °C	
Storage temperature range		-40 °C...+85 °C	
Model No.	1 pc(s).	9635.800	

RiLine Compact accessories

for component adaptors

Support rail

for Comfort component adaptors

For attaching equipment and reverser combinations.

Material:

- Polyamide
- Fire protection corresponding to UL 94-V0

Colour:

- RAL 9005

Width mm	Height mm	Packs of	Model No.
45	56	10 pc(s).	9635.600



Positioner

for Comfort component adaptors

For attaching equipment and reverser combinations.

Material:

- Polyamide
- Fire protection corresponding to UL 94-V0

Colour:

- RAL 9005

Width mm	Height mm	For switchgear make (model)	Packs of	Model No.
45	65	Siemens (S00, S0)	10 pc(s).	9635.610
45	47.5	Eaton (PKZ/PKE size 0)	10 pc(s).	9635.620



Extension module

for Comfort component adaptors

For attaching direct starters of varying lengths.

Material:

- Polyamide
- Fire protection corresponding to UL 94-V0

Colour:

- RAL 7035

Width mm	Height mm	Packs of	Model No.
45	40	8 pc(s).	9635.630



Extension kit

for Comfort component adaptors

For attaching reverser combinations with 90 mm width.

Material:

- Polyamide
- Fire protection corresponding to UL 94-V0

Colour:

- RAL 7035

Supply includes:

- 1 set consisting of 1 expansion module, 2 extension modules, 3 connection pins
- 1 set \triangleq 1 pc(s).

Width mm	Height mm	Packs of	Model No.
90	80	4 pc(s).	9635.640



Mini-PLS busbar system (40 mm)



Component adaptors Page 296 Fuse elements Page 295

Busbar supports, busbar connection adaptors

Material:

- Polyamide
- Fire protection corresponding to UL 94-V0

Colour:

- RAL 7035
- RAL 9011 (busbar connection adaptor chassis)

Contact hazard protection



Material:

- Thermally modified hard PVC
- Fire protection corresponding to UL 94-V0

Colour:

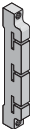
- RAL 7035

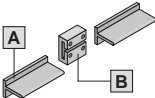
Mini-PLS busbar supports (3-pole)			
	Busbar supports, suitable for top mounting	Packs of	■
	Bar centre distance mm		40
	Approvals		UR
	Model No.	4 pc(s).	9600.000

[A] Mini-PLS special busbars E-Cu, bar thickness 3 mm, bar cross-section 120 mm ²						
	Length mm	Packs of	500	700	1100	1500
	Approvals		UR	UR	UR	UR
	Model No.	3 pc(s).	9601.000	9602.000	9603.000	9624.000
Accessories						
	Busbar connectors	Approvals		Model No.		
		UR	3 pc(s).	9611.000		

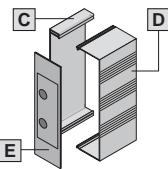
Mini-PLS contact hazard protection					
	Components	Approvals	Length mm	Packs of	Model No.
	[C] Base tray	UR	500	1 pc(s).	9605.000
			700	1 pc(s).	9606.000
			1100	1 pc(s).	9607.000
	[D] Cover section	UR	250	1 pc(s).	9608.000
			500	1 pc(s).	9609.000
[E] End cover	UR	-	2 pc(s).	9610.000	

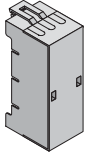
Mini-PLS busbar connection adaptors (3-pole)					Page
	Rated max. current A	Packs of	63	250	
	Rated operating voltage V, ~		690, 3~	690, 3~	
	Cable outlet		Top/bottom	Top/bottom	
	Connection of round conductors mm ²		1.5 – 35	10 – 120	
	Clamping area for laminated copper bars, W x H mm		10 x 8	17 x 15	
	Width mm		54	115	
	Height mm		160	182	
	Approvals		UR	UR	
	Model No.	1 pc(s).	9613.000	9612.000	
	Accessories				
Laminated copper bar			■	■	346



Busbar system Page 294 **Connection adaptors** Page 294 **Connection adaptors** Page 296

Bus-mounting fuse base

Material:

- Polyamide
- Fire protection corresponding to UL 94-V0

Colour:

- Chassis: RAL 9011
- Cover: RAL 7035

NH fuse-switch disconnecter

Material:

- Fibreglass-reinforced polyamide
- Fire protection corresponding to UL 94-V0
- Contact tracks: Silver-plated hard copper

Colour:

- RAL 7035

Basis of test:

- IEC/DIN EN 60 947-3
- DIN EN 60 269-2 (fuse inserts)

Busbar adaptor

Material:

- Polyamide
- Fire protection corresponding to UL 94-V0

Colour:

- RAL 9011

Mini-PLS bus-mounting fuse base (3-pole)			A	B
	Fuse insert	Packs of	D 02-E18	D 02-E18
	Rated max. current A		63	63
	Rated operating voltage V, ~		400, 3~	400, 3~
	Connection of round conductors mm ²		1.5 – 16	1.5 – 16
	Connection type		Spring terminal	Box terminal
	Width mm		39.5	38
	Height mm		189	160
	Model No.	1 pc(s).	9630.005	9630.000

NH fuse-switch disconnecter size 000 (3-pole)			
	Rated operating current max. A	Packs of	100
	Rated operating voltage V, ~		690, 3~
	Cable outlet		Top/bottom
	Connection type		Box terminal
	Connection of round conductors mm ²		1.5 – 50
	Clamping area for laminated copper bars, W x H mm		10 x 10
	Width mm		89
	Height mm		141.5
	Model No.	1 pc(s).	3431.000

Also required

Mini-PLS busbar adaptor (3-pole)			
With connection cables mm ²		35	
Width mm		90	
Height mm		160	
Model No.	1 pc(s).	9629.100	
Accessories			
Micro-switch	5 pc(s).	3071.000	358

Mini-PLS component adaptors

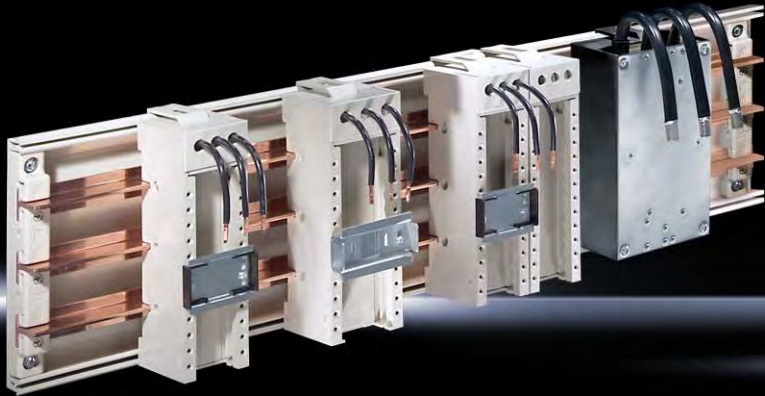

Busbar system Page 294 **Busbar connection adaptors** Page 294 **Fuse elements** Page 295 **Switchgear assignment** Page 297

Material:

- Polyamide (PA 6.6)
- Fire protection corresponding to UL 94-V0

Colour:

- RAL 7035
- RAL 9011 (9629.000)

Rated current max. 12 – 25 A

Rated max. current A	Packs of	12	25	25	25	25	25	25	Page	
Rated operating voltage V, ~		690, 3~	690, 3~	690, 3~	690, 3~	690, 3~	690, 3~	690, 3~		
Number of poles		3-pole	3-pole	3-pole	3-pole	3-pole	3-pole	3-pole		
Connection cables		AWG 14	AWG 12	AWG 12	AWG 12	AWG 12	AWG 12	AWG 12		
Support rails quantity/height mm		1/7.5	1/7.5	1/15	1/7.5	1/15	1/7.5	1/7.5		
Width mm		45	45	45	54	54	72	90		
Height mm		160	160	160	160	160	160	160		
Approvals		UR	UR	UR	UR	UR	UR	-		
Model No.	1 pc(s).	9614.110	9614.100	9615.100	9614.000	9615.000	9625.000	9629.010		
Accessories										
Insert strip	2 pc(s).	9623.000	9623.000	9623.000	9623.000	9623.000	9623.000	9623.000	353	
Support rails, height 7.5 mm	Width 45 mm	10 pc(s).	9320.150	9320.150	9320.150	-	-	-	9320.150	352
	Width 54 mm	10 pc(s).	-	-	-	3548.000	3548.000	-	-	352

Mini-PLS component adaptors

Rated current max. 40 – 100 A

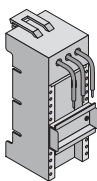
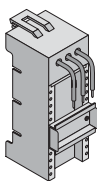
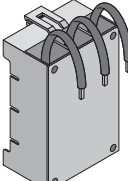
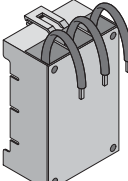
						
Rated max. current A	Packs of	40	40	40	100	Page
Rated operating voltage V, ~		690, 3~	690, 3~	690, 3~	690, 3~	
Number of poles		3-pole	3-pole	3-pole	3-pole	
Connection cables		AWG 10	AWG 10	AWG 10	35 mm ²	
Support rails quantity/height mm		1/7.5	1/15	1/7.5	–	
Width mm		54	54	72	90	
Height mm		160	160	160	160	
Approvals		UR	UR	UR	UR	
Model No.	1 pc(s).	9616.000	9617.000	9627.000	9629.000	
Accessories						
Insert strip		2 pc(s).	9623.000	9623.000	9623.000	–
Support rails	Height 7.5 mm	Width 54 mm	10 pc(s).	3548.000	3548.000	–
	Height 15 mm	Width 72 mm	5 pc(s).	–	–	–
						9320.120
						352

Power distribution

Switchgear assignment – Mini-PLS component adaptors 12 A/25 A

Make/model	Model No.
ABB	
MS116	9614.100
MS325	9614.000
MS450 (max. 25 A)	9614.000
MS451 (max. 25 A)	9614.000
Eaton	
PKZM0 (up to 25 A)	9614.100
PKZM01 (up to 25 A)	9614.100
PKZM4 (up to 25 A)	9614.000
PKE12	9614.100
PKE32 (up to 25 A)	9614.100
PKE65 (up to 25 A)	9614.000
Schneider Electric	
GV2-P (up to 25 A)	9614.100
GV2-RT	9614.100
GV2-LE10	9614.100
GV3 (up to 25 A)	9614.100

Make/model	Model No.
Siemens	
S0	
3RV10 21...	9614.100
3RV20 21... (up to 25 A)	9614.100
S00	
3RV10 11...	9614.100 ¹⁾
3RV20 11...	9614.100 ¹⁾
S2	
3RV10 31... (up to 25 A)	9614.000

¹⁾ Support rail must be offset

Switchgear assignment – Mini-PLS component adaptors 40 A/100 A

Make/model	Model No.	Accessories Model No.
ABB		
MS450 (max. 40 A)	9617.000	–
MS451 (max. 40 A)	9629.000	9320.120
MS495	9629.000	9320.120
MS496	9629.000	9320.120
MS497	9629.000	9320.120
Tmax		
T1	9629.000	–
T2	9629.000	–
Eaton		
NZM 1	9629.000	–
PKZ2	9627.000	–
PKZM4 (max. 40 A)	9617.000	–
PKZM4	9629.000	9320.120

Make/model	Model No.	Accessories Model No.
Schneider Electric		
NS 80	9629.000	–
GV3 (max. 40 A)	9616.000	–
GV3	9629.000	9320.120
Siemens		
S2		
3RV10 31... (max. 40 A)	9616.000	–
3RV10 31...	9629.000	9320.120
S3		
3RV1341/42	9629.000	9320.120

Rittal – The System.

Faster – better – everywhere.



RiLine

Busbar systems 3-/4-pole and DC

Support + bars + contact hazard protection

- Flat copper bar system, see page 300
- PLS busbar system, see page 302
- Accessories, see page 340



Connection system 3- and 4-pole

- Busbar connection adaptors, see page 304
- Connection clamps, see page 349
- Connection block, see page 351
- Accessories, see page 349



Component adaptors 3- and 4-pole

- OM adaptors, see page 307
- Circuit-breaker component adaptors, see page 314
- Accessories, see page 352



Fuse elements 3-pole

- Bus-mounting fuse bases, see page 323
- NH fuse-switch disconnectors, see page 325
- NH slimline fuse-switch disconnectors, see page 335
- Fuse holders, see page 337
- Accessories, see page 356



VX25 Power Engineering

see page 446

- Simple component selection, integral switchgear database
- Automatic calculation of rated currents and heat losses
- Configuration of RiLine busbar systems (offline version RPE 7.0)



RiLine busbar systems up to 800 A (60 mm)



Busbar connection adaptors Page 304 **OM adaptors** Page 307 **Circuit-breaker component adaptors** Page 314 **Fuse elements** Page 323

Material:

- Polyamide
- Fire protection corresponding to UL 94-V0

Colour:

- RAL 7035

Note:



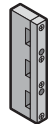
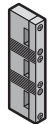
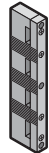

- UL approval only valid in conjunction with AC applications
- The use of a base tray is required for UL applications.

Flat copper busbar system

Busbar supports							
Number of poles	Packs of	3-pole	3-pole	3-pole	4-pole	Page	
Bar centre distance mm		60	60	60	60		
External attachment		■	-	-	-		
Internal attachment		-	■	■	■		
For busbars mm	12 x 5/10	■	■	-	■		
	15 x 5 – 30 x 10	■	■	■	■		
Rated operating voltage V, ~		1000, 3~	1000, 3~	1000, 3~	1000, 3~		
		-	-	1500 (DC)	-		
Approvals		-	-	UL	UL		
Model No.	4 pc(s).	9340.010	9340.000	9340.050	9340.004		
Also required							
Spacers when using busbars 12 x 5/10 mm			■	■	-	■	
Model No.	12 pc(s).	9340.090	9340.090	-	9340.090	341	

RiLine busbar systems up to 800 A (60 mm)

Flat copper busbar system

Busbar supports						
						
Number of poles	Packs of	3-pole	3-pole	3-pole	4-pole	Page
Bar centre distance mm		60	60	60	60	
Model No.	4 pc(s).	9340.010	9340.000	9340.050	9340.004	300
Also required						
Spacer when using busbars 12 x 5/10 mm		■	■	–	■	
Model No.	12 pc(s).	9340.090	9340.090	–	9340.090	341

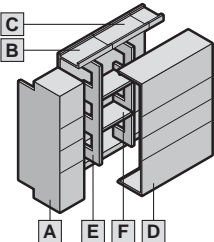
Contact hazard protection									
	Components	Length mm	Approvals	Packs of	Model No.			Model No.	Page
	A End covers	–	UL	2 pc(s).	9340.070	9340.070	9340.070	9340.074	–
	B Base trays	500	UL	2 pc(s).	–	9340.100	9340.100	–	347
		700	UL	2 pc(s).	–	9340.110	9340.110	–	347
		900	UL	2 pc(s).	–	9340.120	9340.120	–	347
		1100	UL	2 pc(s).	–	9340.130	9340.130	9340.134	347
		2400	UL	1 pc(s).	–	9340.170	9340.170	–	347
	C Base tray infills	100	UL	2 pc(s).	–	9340.140	9340.140	–	347
	D Cover sections	700	UL	2 pc(s).	–	9340.200	9340.200	–	348
		1100	UL	2 pc(s).	–	9340.210	9340.210	9340.214	348
E Support panels	–	UL	5 pc(s).	–	9340.220	9340.220	9340.224	348	
F Cross members	160	UL	2 pc(s).	–	–	9340.230	–	348	

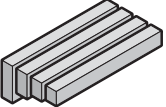
Busbars E-Cu, length: 2400 mm/bar										
	Dimensions mm	Max. rated current A according to		Approvals	Packs of	Model No.			Model No.	Page
		DIN ¹⁾	UL 508							
	12 x 5	210	160	UL	6 pc(s).	3580.000	3580.000	3580.000	3580.000	342
	12 x 10	340	320	UL	6 pc(s).	3580.100	3580.100	3580.100	3580.100	342
	15 x 5	260	200	UL	6 pc(s).	3581.000	3581.000	3581.000	3581.000	342
	15 x 10	360	400	UL	6 pc(s).	3581.100	3581.100	3581.100	3581.100	342
	20 x 5	274	270	UL	6 pc(s).	3582.000	3582.000	3582.000	3582.000	342
	20 x 10	427	540	UL	3 pc(s).	3585.005	3585.005	3585.005	3585.005	342
	25 x 5	327	330	UL	6 pc(s).	3583.000	3583.000	3583.000	3583.000	342
30 x 5	379	400	UL	6 pc(s).	3584.000	3584.000	3584.000	3584.000	342	
30 x 10	573	810	UL	3 pc(s).	3586.005	3586.005	3586.005	3586.005	342	

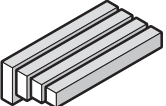
CUPONAL busbars, length: 2400 mm/bar										
	Dimensions mm	Max. rated current A according to		Approvals	Packs of	Model No.			Model No.	Page
		DIN ¹⁾	UL 508							
	20 x 5	235	–	–	6 pc(s).	–	3582.020	3582.020	–	342
	20 x 10	363	–	–	3 pc(s).	–	3585.020	3585.020	–	342
	30 x 5	328	–	–	6 pc(s).	–	3584.020	3584.020	–	342
30 x 10	493	–	–	3 pc(s).	–	3586.020	3586.020	–	342	

Accessories								
Components	For busbars mm	Approvals	Packs of	Model No.			Model No.	Page
Busbar connectors for single connection	12 x 5 – 15 x 10	UL	3 pc(s).	9350.075	9350.075	9350.075	9350.075	343
	20 x 5 – 30 x 10	UL	3 pc(s).	9320.020	9320.020	9320.020	9320.020	343
Busbar connectors for baying connection ²⁾	20 x 5 – 30 x 10	UL	3 pc(s).	9320.030	9320.030	9320.030	9320.030	343
Busbar cover sections Length: 1000 mm/section	12 x 5 – 30 x 10	UR	10 pc(s).	3092.000	3092.000	3092.000	3092.000	343
	12/15 x 5	UR	4 pc(s).	9350.010	9350.010	9350.010	9350.010	343
	12/15 x 10	UR	4 pc(s).	9350.060	9350.060	9350.060	9350.060	343

¹⁾ Maximum rated value of an exposed, uncovered busbar at a temperature increase of 30 K to DIN 43 671

²⁾ Connection from enclosure to enclosure

RiLine busbar systems 800 A/1600 A (60 mm)

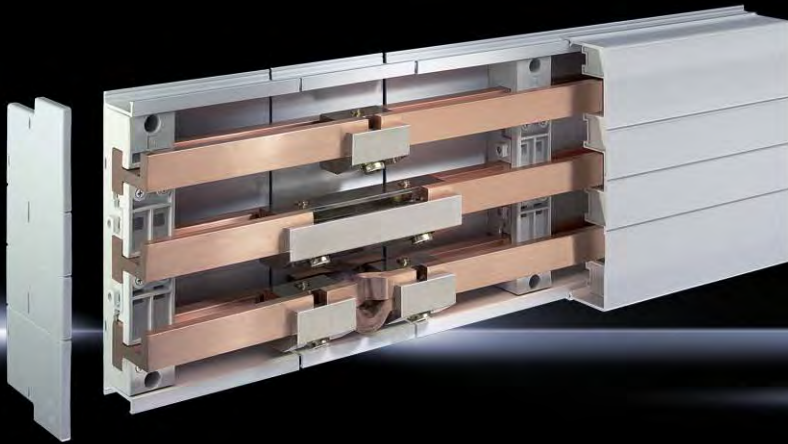

Busbar connection adaptors Page 304 **OM adaptors** Page 307 **Circuit-breaker component adaptors** Page 314 **Fuse elements** Page 323

Material:

- Polyamide
- Fire protection corresponding to UL 94-V0

Colour:

- RAL 7035

Note:





- UL approval only valid in conjunction with AC applications
- The use of a base tray is required for UL applications.

PLS busbar system

Busbar supports						
		PLS 800		PLS 1600		
		3-pole	3-pole	3-pole	3-pole	4-pole
For Rittal system	Packs of			PLS 1600 PLUS		
Number of poles		3-pole	3-pole	3-pole	3-pole	4-pole
Bar centre distance mm		60	60	60	60	60
Internal attachment		■	■	■	■	■
Busbar support, suitable for top mounting		■	■	■	■	-
Rated operating voltage V, ~		1000, 3~	1000, 3~	1000, 3~	1000, 3~	1000, 3~
		-	1500 (DC)	-	1500 (DC)	-
Approvals		-	UL	-	UL	UL
Model No.	4 pc(s).	9341.000	9341.050	9342.000	9342.050	9342.004

RiLine busbar systems 800 A/1600 A (60 mm)

PLS busbar system

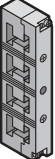
Busbar supports							
							 PLS 1600 PLUS
For Rittal system	Packs of	PLS 800		PLS 1600			Page
Number of poles		3-pole	3-pole	3-pole	3-pole	4-pole	
Bar centre distance mm		60	60	60	60	60	
Model No.	4 pc(s).	9341.000	9341.050	9342.000	9342.050	9342.004	302

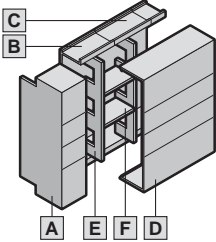
Contact hazard protection										
	Components	Length mm	Approvals	Packs of	Model No.		Model No.			Page
	A End covers	–	UL	2 pc(s).	9341.070	9341.070	9342.070	9342.070	9342.074	–
	B Base trays	500	UL	2 pc(s).	9341.100	9341.100	9342.100	9342.100	–	347
		700	UL	2 pc(s).	9341.110	9341.110	9342.110	9342.110	–	347
		900	UL	2 pc(s).	9341.120	9341.120	9342.120	9342.120	–	347
		1100	UL	2 pc(s).	9341.130	9341.130	9342.130	9342.130	9342.134	347
	2400	UL	1 pc(s).	9341.170	–	9342.170	–	–	347	
	C Base tray infills	100	UL	2 pc(s).	9341.140	9341.140	9342.140	9342.140	–	347
D Cover sections	700	UL	2 pc(s).	9340.200	9340.200	9340.200	9340.200	–	348	
	1100	UL	2 pc(s).	9340.210	9340.210	9340.210	9340.210	9340.214	348	
E Support panels	–	UL	5 pc(s).	9340.220	9340.220	9340.220	9340.220	9340.224	348	
F Cross members	160	UL	2 pc(s).	–	9340.230	–	9340.230	–	348	

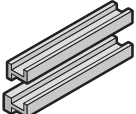
PLS special busbars E-Cu											
	Version			Packs of	PLS 800		PLS 1600			Page	
	Bar cross-section mm ²				300		900				
	Bar thickness mm				5		10				
	Max. rated current A acc. to	DIN ¹⁾				684		1368			
		UL 508				890		1500			
	Length mm	For enclosure width mm	Approvals			Model No.		Model No.			
	495	600	UL	3 pc(s).		3524.000		3527.000			344
	695	800	UL	3 pc(s).		3525.000		3528.000			344
895	1000	UL	3 pc(s).		3525.010		3528.010			344	
1095	1200	UL	3 pc(s).		3526.000		3529.000			344	
2400	variable	UL	1 pc(s).		3509.000		3516.000			344	

Accessories										
Components		Approvals	Packs of		Model No.		Model No.			Page
PLS busbar connectors	Single connection	UL	3 pc(s).		3504.000		3514.000			344
	Bayed connection ²⁾	UL	3 pc(s).		3505.000		3515.000			344
PLS expansion connector ³⁾		UR	3 pc(s).		9320.060		9320.070			345

¹⁾ Maximum rated value of an exposed, uncovered busbar at a temperature increase of 30 K to DIN 43 671

²⁾ Connection from enclosure to enclosure

³⁾ 2 PLS busbar connectors (single connection) are required to fit one expansion connector

Connection adaptors



Busbar system Page 300 **OM adaptors** Page 307 **Circuit-breaker component adaptors** Page 314 **Fuse elements** Page 323

Material:

- Cover: ABS
- Punched section: Polyamide
- Chassis 3439.010: Fibreglass-reinforced, thermoplastic polyester (PBT)
- Fire protection corresponding to UL 94-V0





Colour:

- RAL 7035

Note:

- The technical data may vary for UL applications
- UL approval only applies in conjunction with AC application
- The rated operating voltage for DC applications depends on the busbar arrangement in the busbar supports 9340.050/9341.050/9342.050.

Rated current max. 63 – 125 A

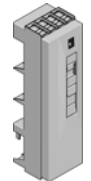

							
Rated current max. A	Packs of	63	63	125	125	125	Page
Rated operating voltage V, ~		690, 3~	690, 3~	690, 3~	690, 3~	690, 4~	
Rated operating voltage (L1 + L2) V		-	1000 (DC)	-	1000 (DC)	-	
Rated operating voltage (L1 + L3) V		-	1500 (DC)	-	1500 (DC)	-	
Number of poles		3-pole	3-pole	3-pole	3-pole	4-pole	
Cable outlet		Top	Bottom	Top/bottom	Bottom	Top/bottom	
Connection of round conductors, fine wire with wire end ferrule mm ²		2.5 - 10	2.5 - 10	10 - 25	10 - 25	10 - 25	
Connection of round conductors, multi-wire mm ²		2.5 - 10	2.5 - 10	16 - 35	16 - 35	16 - 35	
Connection of round conductors, single-wire mm ²		2.5 - 10	2.5 - 10	-	-	-	
Clamping area for laminated copper bars (W x H) mm		-	-	10 x 7.8	10 x 7.8	10 x 7.8	
Clamping area for laminated copper bars with 5 mm bar thickness (W x H)		-	-	-	-	-	
Clamping area for laminated copper bars with 10 mm bar thickness (W x H)		-	-	-	-	-	
Width mm		20	20	55	55	75	
Height mm		215	215	210	210	270	
Approvals		UL	UL	UR	UL	UL	
For bar systems with centre-to-centre spacing mm		60	60	60	60	60	
For bar thickness mm		5/10	5/10	5/10	5/10	5/10	
Model No.	1 pc(s).	9342.200	9342.210	9342.220	9342.240	9342.224	
Accessories							
Laminated copper bar		-	-	see page	see page	see page	346
Connection adaptor expansion set		-	-	-	-	-	

Connection adaptors

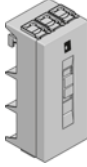
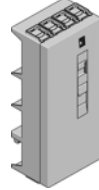
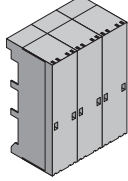
Rated current max. 250 – 600 A

						
Rated current max. A	Packs of	250	250	250	600	Page
Rated operating voltage V, ~		690, 3~	690, 3~	690, 4~	690, 3~	
Rated operating voltage (L1 + L2) V		–	1000 (DC)	–	–	
Rated operating voltage (L1 + L3) V		–	1500 (DC)	–	–	
Number of poles		3-pole	3-pole	4-pole	3-pole	
Cable outlet		Top/bottom	Bottom	Top/bottom	Top/bottom	
Connection of round conductors, fine wire with wire end ferrule mm ²		35 - 120	35 - 120	35 - 120	35 - 240	
Connection of round conductors, multi-wire mm ²		35 - 120	35 - 120	35 - 120	35 - 240	
Connection of round conductors, single-wire		–	–	–	–	
Clamping area for laminated copper bars (W x H) mm		18.5 x 15.5	18.5 x 15.5	18.5 x 15.5	24 x 21	
Clamping area for laminated copper bars with 5 mm bar thickness (W x H)		–	–	–	–	
Clamping area for laminated copper bars with 10 mm bar thickness (W x H)		–	–	–	–	
Width mm		90	90	118	180	
Height mm		210	210	270	247	
Approvals		UL	UL	UL	–	
For bar systems with centre-to-centre spacing mm		60	60	60	60	
For bar thickness mm		5/10	5/10	5/10	5/10	
Model No.	1 pc(s).	9342.250	9342.270	9342.254	3439.010	
Accessories						
Laminated copper bar		see page	see page	see page	see page	346
Connection adaptor expansion set		–	–	–	–	

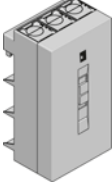
Rated current max. 800 – 1600 A

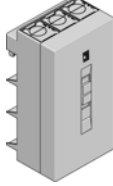
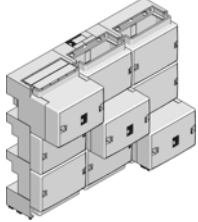
						
Rated current max. A	Packs of	800	800	800	1600	Page
Rated operating voltage V, ~		690, 3~	690, 3~	690, 3~	690, 3~	
Rated operating voltage (L1 + L2) V		–	1000 (DC)	1000 (DC)	1000 (DC)	
Rated operating voltage (L1 + L3) V		–	1500 (DC)	1500 (DC)	1500 (DC)	
Number of poles		3-pole	3-pole	3-pole	3-pole	
Cable outlet		Top/bottom	Top/bottom	Bottom	Top/bottom	
Connection of round conductors, fine wire with wire end ferrule mm ²		95 - 185	95 - 185	95 - 185	–	
Connection of round conductors, multi-wire mm ²		95 - 300	95 - 300	95 - 300	–	
Connection of round conductors, single-wire		–	–	–	–	
Clamping area for laminated copper bars (W x H) mm		33 x 20	–	33 x 20	–	
Clamping area for laminated copper bars with 5 mm bar thickness (W x H) mm		–	33 x 26	–	65 x 27	
Clamping area for laminated copper bars with 10 mm bar thickness (W x H) mm		–	33 x 21	–	65 x 22	
Width mm		129	150	129	255	
Height mm		246	210	246	210	
Approvals		UR	UL	UL	UL	
For bar systems with centre-to-centre spacing mm		60	60	60	60	
For bar thickness mm		5/10	5/10	5/10	5/10	
Model No.	1 pc(s).	9342.280	9342.310	9342.300	9342.320	
Accessories						
Laminated copper bar		see page	see page	see page	see page	346
Connection adaptor expansion set	1 pc(s).	–	9342.314	–	9342.324	306

Connection adaptor expansion set



Busbar system Page 300 **OM adaptors** Page 307 **Circuit-breaker component adaptors** Page 314 **Fuse elements** Page 323

Single-pole extra set to complement the 3-pole connection adaptor for 4-pole configurations.

Material:

- Cover: ABS
- Punched section: Polyamide
- Fire protection corresponding to UL 94-V0

Colour:

- RAL 7035

Note:

- The technical data may vary for UL applications
- UL approval only applies in conjunction with AC application

for 4-pole configuration

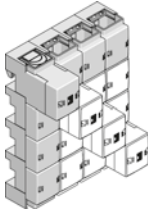
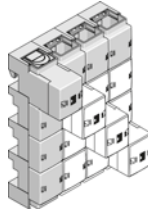
				
To fit Model No.	Packs of	9342.310	9342.320	Page
Rated current max. A		800	1600	
Rated operating voltage V, ~		690, 1~	690, 1~	
Number of poles		Single-pole	Single-pole	
Connection of round conductors, fine wire with wire end ferrule mm ²		95 - 185	-	
Connection of round conductors, multi-wire mm ²		95 - 300	-	
Clamping area for laminated copper bars with 5 mm bar thickness (W x H) mm		33 x 26	65 x 27	
Clamping area for laminated copper bars with 10 mm bar thickness (W x H) mm		33 x 21	65 x 22	
Width mm		50	85	
Height mm		270	270	
Approvals		UL	UL	
For bar systems with centre-to-centre spacing mm		60	60	
For bar thickness mm		5/10	5/10	
Model No.	1 pc(s).	9342.314	9342.324	
Accessories				
Laminated copper bar		see page	see page	346



Busbar system Page 300 **Connection adaptors** Page 304 **Fuse elements** Page 323 **Allocation of switchgear** Page 319

Material:

- Polyamide
- Fire protection corresponding to UL 94-V0

Colour:

- Chassis: RAL 7035

Note:

- The technical data may vary for UL applications

Rated current max. 16 A, with connection cables

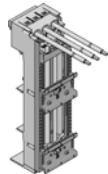
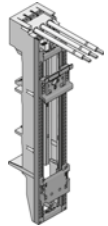
				
Rated current max. A	Packs of	16	16	Page
Rated operating voltage V, ~		690, 3~	690, 3~	
Number of poles		3-pole	3-pole	
Connection cables, Design		AWG 12	AWG 12	
Connection cables, Length mm		165	165	
With support frame mm		45 x 170	45 x 237	
With support frame support		-	■	
With PinBlock		-	■	
With insert strips		-	-	
Support rails Qty/height mm		2 / 10	1 / 10	
Support rail version		TS 45D TS 45D-V	TS 45D	
Width mm		45	45	
Height mm		208	272	
Approvals		UL	UL	
For bar systems with centre-to-centre spacing mm		60	60	
For bar thickness mm		5/10	5/10	
Model No.	1 pc(s).	9340.780	9340.760	
Accessories				
Support rail 35 x 10 mm		see page	see page	352
Insert strip	2 pc(s).	9340.290	9340.290	353
Connection pin	20 pc(s).	9340.280	9340.280	354
PinBlock	5 pc(s).	9342.800	-	354
OM supports		see page	see page	313

OM adaptors

Rated current max. 25 A, with connection cables

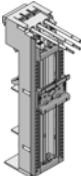
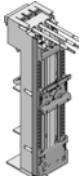
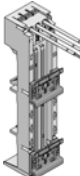
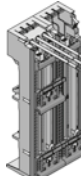
							
Rated current max. A	Packs of	25	25	25	25	25	Page
Rated operating voltage V, ~		690, 3~	690, 3~	690, 3~	690, 3~	690, 3~	
Number of poles		3-pole	3-pole	3-pole	3-pole	3-pole	
Connection cables, Design		AWG 12	AWG 12	AWG 12	AWG 12	AWG 12	
Connection cables, Length mm		130	130	130	130	130	
With support frame mm		–	45 x 170	45 x 170	–	45 x 170	
With support frame support		–	–	–	–	–	
With PinBlock		–	–	■	–	–	
With insert strips		–	–	–	–	–	
Support rails Qty/height mm		1 / 10	1 / 10	1 / 10	2 / 10	3 / 10	
Support rail version		TS 45C	TS 45C	TS 45C	TS 45D	TS 45D TS 45D-V	
Width mm		45	45	45	45	90	
Height mm		208	208	208	208	208	
Approvals		–	–	–	–	–	
For bar systems with centre-to-centre spacing mm		60	60	60	60	60	
For bar thickness mm		5/10	5/10	5/10	5/10	5/10	
Model No.	1 pc(s).	9340.310	9340.340	9340.370	9340.320	9340.400	
Accessories							
Support rail 35 x 10 mm		see page	see page	see page	see page	see page	352
Insert strip	2 pc(s).	9340.290	9340.290	9340.290	9340.290	–	353
Connection pin	20 pc(s).	9340.280	9340.280	9340.280	9340.280	–	354
PinBlock	5 pc(s).	–	9342.800	–	–	9342.800	354
OM supports		see page	see page	see page	see page	–	313

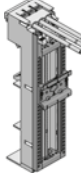
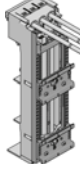
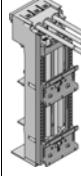
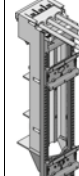
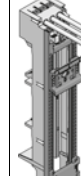
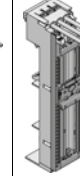
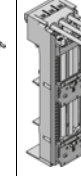

Rated current max. 32 A, with connection cables

									
Rated current max. A	Packs of	32	32	32	32	32	32	32	Page
Rated operating voltage V, ~		690, 3~	690, 3~	690, 3~	690, 3~	690, 3~	690, 3~	690, 3~	
Number of poles		3-pole	3-pole	3-pole	3-pole	3-pole	3-pole	3-pole	
Connection cables, Design		AWG 10	AWG 10	AWG 10	AWG 10	AWG 10	AWG 10	AWG 10	
Connection cables, Length mm		130	130	165	130	165	130	130	
With support frame mm		45 x 170	45 x 170	45 x 170	45 x 237	45 x 237	55 x 170	55 x 170	
With support frame support		–	–	–	■	■	–	–	
With PinBlock		–	–	–	–	■	–	–	
With insert strips		–	–	–	–	–	–	–	
Support rails Qty/height mm		1 / 10	2 / 10	2 / 10	2 / 10	1 / 10	1 / 10	2 / 10	
Support rail version		TS 45C	TS 45D TS 45D-V	TS 45D TS 45D-V	TS 45D TS 45D-V	TS 45D	TS 55D	TS 55D TS 55D-V	
Width mm		45	45	45	45	45	55	55	
Height mm		208	208	208	272	272	208	208	
Approvals		–	–	–	–	–	–	–	
For bar systems with centre-to-centre spacing mm		60	60	60	60	60	60	60	
For bar thickness mm		5/10	5/10	5/10	5/10	5/10	5/10	5/10	
Model No.	1 pc(s).	9340.350	9340.380	9340.790	9340.390	9340.770	9340.460	9340.470	
Accessories									
Support rail 35 x 10 mm		see page	see page	see page	see page	see page	see page	see page	352
Insert strip	2 pc(s).	9340.290	9340.290	9340.290	9340.290	9340.290	9340.290	9340.290	353
Connection pin	20 pc(s).	9340.280	9340.280	9340.280	9340.280	9340.280	9340.280	9340.280	354
PinBlock	5 pc(s).	9342.800	9342.800	9342.800	9342.800	9342.800	9342.810	9342.810	354
OM supports		see page	see page	see page	see page	see page	see page	see page	313

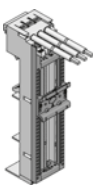
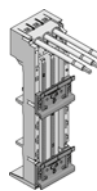
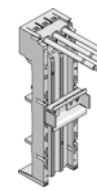
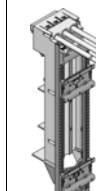
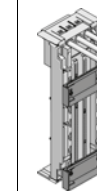
Rated current max. 40 A, with connection cables

							
Rated current max. A	Packs of	40	40	40	40	40	Page
Rated operating voltage V, ~		690, 3~	690, 3~	690, 3~	690, 3~	690, 3~	
Number of poles		3-pole	3-pole	3-pole	3-pole	3-pole	
Connection cables, Design		AWG 8	AWG 8	AWG 8	AWG 8	AWG 8	
Connection cables, Length mm		130	130	130	130	130	
With support frame mm		55 x 170	–	–	55 x 237	–	
With support frame support		–	–	–	■	–	
With PinBlock		–	–	–	–	–	
With insert strips		–	–	–	–	■	
Support rails Qty/height mm		1 / 10	2 / 10	1 / 15	2 / 10	2 / 7.5	
Support rail version		TS 55D	TS 55D	Metal	TS 55D TS 55D-V	Metal	
Width mm		55	55	55	55	75	
Height mm		208	208	208	272	208	
Approvals		–	–	–	–	–	
For bar systems with centre-to-centre spacing mm		60	60	60	60	60	
For bar thickness mm		5/10	5/10	5/10	5/10	5/10	
Model No.	1 pc(s).	9340.720	9340.740	9340.750	9340.730	9340.710	
Accessories							
Support rail 35 x 10 mm		see page	see page	see page	see page	–	352
Insert strip	2 pc(s).	9340.290	9340.290	9340.290	9340.290	–	353
Connection pin	20 pc(s).	9340.280	9340.280	9340.280	9340.280	9340.280	354
PinBlock	5 pc(s).	9342.810	–	–	9342.810	–	354
OM supports		see page	see page	see page	see page	see page	313

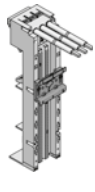
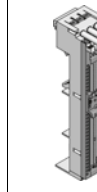
Rated current max. 65 A, with connection cables

						
Rated current max. A	Packs of	65	65	65	65	Page
Rated operating voltage V, ~		690, 3~	690, 3~	690, 3~	690, 3~	
Number of poles		3-pole	3-pole	3-pole	3-pole	
Connection cables, Design		AWG 6	AWG 6	AWG 6	AWG 6	
Connection cables, Length mm		130	130	130	130	
With support frame mm		–	55 x 170	55 x 237	–	
With support frame support		–	–	■	–	
With PinBlock		–	–	–	–	
With insert strips		–	–	–	■	
Support rails Qty/height mm		1 / 10	1 / 10	2 / 10	1 / 7.5	
Support rail version		TS 55E	TS 55E	TS 55E TS 55D-V	Metal	
Width mm		55	55	55	75	
Height mm		208	208	272	208	
Approvals		–	–	–	–	
For bar systems with centre-to-centre spacing mm		60	60	60	60	
For bar thickness mm		5/10	5/10	5/10	5/10	
Model No.	1 pc(s).	9340.410	9340.430	9340.450	9340.700	
Accessories						
Support rail 35 x 10 mm		see page	see page	see page	–	352
Insert strip	2 pc(s).	9340.290	9340.290	9340.290	–	353
Connection pin	20 pc(s).	9340.280	9340.280	9340.280	–	354
PinBlock	5 pc(s).	–	9342.810	9342.810	–	354
OM supports		see page	see page	see page	see page	313

OM adaptors



Busbar system Page 300 **Connection adaptors** Page 304 **Fuse elements** Page 323 **Allocation of switchgear** Page 319







Material:

- Polyamide
- Fire protection corresponding to UL 94-V0





Colour:

- Chassis: RAL 7035

Rated current max. 32 A, with spring terminals

								
Rated current max. A	Packs of	32	32	32	32	32	32	Page
Rated operating voltage V, ~		690, 3~	690, 3~	690, 3~	690, 3~	690, 3~	690, 3~	
Number of poles		3-pole	3-pole	3-pole	3-pole	3-pole	3-pole	
Connection of round conductors mm ²		1.5 - 6	1.5 - 6	1.5 - 6	1.5 - 6	1.5 - 6	1.5 - 6	
With support frame mm		-	-	45 x 170	45 x 170	45 x 237	55 x 170	
With support frame support		-	-	-	-	■	-	
With PinBlock		-	-	-	■	-	-	
Support rails Qty/height mm		1 / 10	2 / 10	1 / 10	1 / 10	2 / 10	1 / 10	
Support rail version		TS 45C	TS 45D	TS 45C	TS 45C	TS 45D TS 45D-V	TS 55D	
Width mm		45	45	45	45	45	55	
Height mm		208	208	208	208	272	208	
For bar systems with centre-to-centre spacing mm		60	60	60	60	60	60	
For bar thickness mm		5/10	5/10	5/10	5/10	5/10	5/10	
Model No.	1 pc(s).	9340.510	9340.520	9340.530	9340.550	9340.560	9340.660	
Accessories								
Support rail 35 x 10 mm		see page	see page	see page	see page	see page	see page	352
Insert strip	2 pc(s).	9340.290	9340.290	9340.290	9340.290	9340.290	9340.290	353
Connection pin	20 pc(s).	9340.280	9340.280	9340.280	9340.280	9340.280	9340.280	354
PinBlock	5 pc(s).	-	-	9342.800	9342.800	9342.800	9342.810	354
Cable set		see page	see page	see page	see page	see page	see page	354
Twin cord		-	-	-	-	-	-	
OM supports		see page	see page	see page	see page	see page	see page	313

Rated current max. 65 A, with spring terminals

						
Rated current max. A	Packs of	65	65	65	65	Page
Rated operating voltage V, ~		690, 3~	690, 3~	690, 3~	690, 3~	
Number of poles		3-pole	3-pole	3-pole	3-pole	
Connection of round conductors mm ²		2.5 - 16	2.5 - 16	2.5 - 16	2.5 - 16	
According to a heat dissipation test to IEC 61 439-1, a current carrying capacity of up to 80 A is supported		■	■	■	■	
With support frame mm		-	-	55 x 170	55 x 237	
With support frame support		-	-	-	■	
With PinBlock		-	-	-	-	
Support rails Qty/height mm		1 / 10	2 / 10	1 / 10	2 / 10	
Support rail version		TS 55E	TS 55E TS 55D	TS 55E	TS 55E TS 55D-V	
Width mm		55	55	55	55	
Height mm		208	208	208	272	
For bar systems with centre-to-centre spacing mm		60	60	60	60	
For bar thickness mm		5/10	5/10	5/10	5/10	
Model No.	1 pc(s).	9340.610	9340.620	9340.630	9340.650	
Accessories						
Support rail 35 x 10 mm		see page	see page	see page	see page	352
Insert strip	2 pc(s).	9340.290	9340.290	9340.290	9340.290	353
Connection pin	20 pc(s).	9340.280	9340.280	9340.280	9340.280	354
PinBlock	5 pc(s).	-	-	9342.810	9342.810	354
Cable set		see page	see page	see page	see page	354
Twin cord		see page	see page	see page	see page	355
OM supports		see page	see page	see page	see page	313

Rittal – The System.

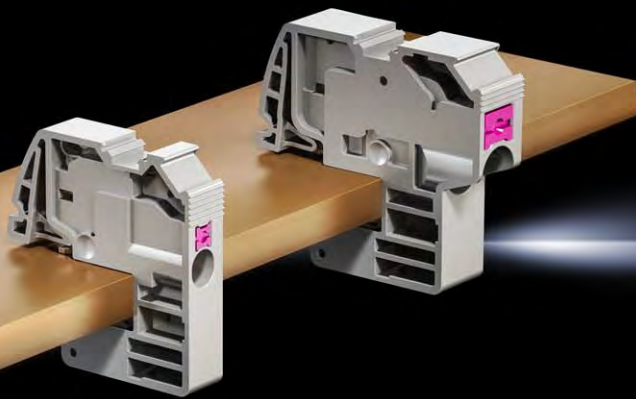

Conductor connection clamps

see page 349

OM adaptors



Busbar system Page 300 **Connection adaptors** Page 304 **Fuse elements** Page 323

Material:

- Polyamide
- Fire protection corresponding to UL 94-V0

Colour:

- Chassis: RAL 7035

Rated current max. 25 A, with plug-in cable outlet

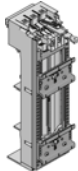
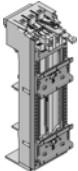
				
Rated current max. A	Packs of	25	25	Page
Rated operating voltage V, ~		690, 3~	690, 3~	
Number of poles		3-pole	3-pole	
Connection of round conductors mm ²		1.5 - 4	1.5 - 4	
With support frame mm		45 x 170	55 x 170	
Support rails Qty/height mm		2 / 10	2 / 10	
Support rail version		TS 45D TS 45D-V	TS 55D TS 55D-V	
Width mm		45	55	
Height mm		208	208	
For bar systems with centre-to-centre spacing mm		60	60	
For bar thickness mm		5/10	5/10	
Model No.	1 pc(s).	9340.910	9340.930	
Product-specific scope of supply				
Connector with connection facility for 3 main contacts (1.5 - 4 mm ²)		■	■	
Accessories				
Support rail 35 x 10 mm		see page	see page	352
Cable set		see page	see page	354





Busbar system Page 300 **Connection adaptors** Page 304 **Fuse elements** Page 323

For mounting of switchgear with external power supply.

Material:
 - Polyamide
 - Fire protection corresponding to UL 94-V0

Colour:
 - Chassis: RAL 7035

without contact system

					
Number of poles	Packs of	-	-	-	Page
With support frame mm		45 x 170	55 x 237	-	
With support frame support		-	■	-	
With PinBlock		■	-	-	
Support rails Qty/height mm		-	1 / 10	2 / 10	
Support rail version		-	TS 55D-V	TS 45D	
Width mm		45	55	45	
Height mm		208	272	208	
Approvals		UL	UL	UL	
For bar systems with centre-to-centre spacing mm		60	60	60	
For bar thickness mm		5/10	5/10	5/10	
Model No.	1 pc(s).	9340.260	9340.270	9340.300	
Accessories					
Support rail 35 x 10 mm		see page	see page	see page	352
Insert strip	2 pc(s).	9340.290	9340.290	9340.290	353
Connection pin	20 pc(s).	9340.280	9340.280	9340.280	354

Circuit-breaker component adaptors



Busbar system Page 300 **Connection adaptors** Page 304 **Fuse elements** Page 323

Material:

- Polyamide
- Fire protection corresponding to UL 94-V0

Colour:

- RAL 7035

Note:

- Cable outlet: Switch outlet or as outgoing cable from the switchgear

- The technical data may vary for UL applications

Rated current max. 100 – 125 A, 3-pole

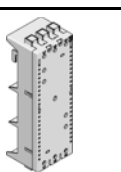
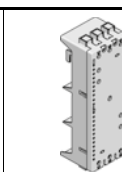
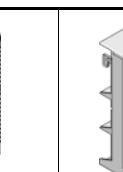
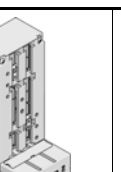
						
Rated current max. A	Packs of	100	100	125	125	Page
Rated operating voltage V, ~		690, 3~	690, 3~	690, 3~	690, 3~	
Number of poles		3-pole	3-pole	3-pole	3-pole	
Cable outlet		Top	Bottom	Top	Bottom	
Type of connection		Box terminal	Box terminal	Box terminal	Box terminal	
Connection of round conductors mm ²		10 - 35	10 - 35	35 - 120	35 - 120	
Clamping area for laminated copper bars (W x H) mm		10 x 7.8	10 x 7.8	18.5 x 15.5	18.5 x 15.5	
For switchgear make (model)		ABB (MS 495, MS 496, MS 497) Eaton (PKZ2) Schneider Electric (GV3ME80) Siemens (S3)	ABB (MS 495, MS 496, MS 497) Eaton (PKZ2) Schneider Electric (GV3ME80) Siemens (S3)	ABB (S1, S2, T1, T1 UL, T2, T2 UL, XT1, XT2) Allen Bradley (140-CMN) Eaton (NZM1, NZM1 UL, BZM B1) GE (FD160) OEZ (BC160N) Schneider Electric (NS80, NSC100, NSE75, NSE100) Schrack (MC1) Siemens (3RV13 53, 3VT1, 3VA10, 3VA11, 3VA51) Terasaki (E125, S125)	ABB (S1, S2, T1, T1 UL, T2, T2 UL, XT1, XT2) Allen Bradley (140-CMN) Eaton (NZM1, NZM1 UL, BZM B1) GE (FD160) OEZ (BC160N) Schneider Electric (NS80, NSC100, NSE75, NSE100) Schrack (MC1) Siemens (3RV13 53, 3VT1, 3VA10, 3VA11, 3VA51) Terasaki (E125, S125)	
Width mm		72	72	90	90	
Height mm		210	210	225	225	
Approvals		UL	UL	UL	UL	
For bar systems with centre-to-centre spacing mm		60	60	60	60	
For bar thickness mm		5/10	5/10	5/10	5/10	
Model No.	1 pc(s).	9342.400	9342.410	9342.540	9342.550	
Product-specific scope of supply						
Terminal cover		-	-	■	■	
Sliding blocks		-	-	■	■	
Accessories						
Support rail 35 x 15 mm	5 pc(s).	9320.120	9320.120	-	-	353
Connection bracket	3 pc(s).	-	-	9342.570	9342.570	355
Insert strip		-	-	-	-	

Circuit-breaker component adaptors

Rated current max. 160 – 250 A, 3-pole

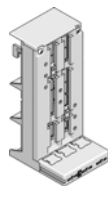
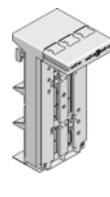
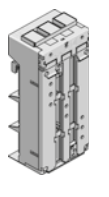
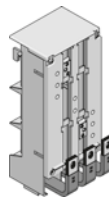
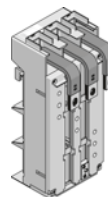
							
Rated current max. A	Packs of	160	160	250	250	250	Page
Rated operating voltage V, ~		690, 3~	690, 3~	690, 3~	690, 3~	690, 3~	
Number of poles		3-pole	3-pole	3-pole	3-pole	3-pole	
Cable outlet		Top	Bottom	Bottom	Top	Bottom	
Type of connection		Box terminal	Box terminal	Box terminal	–	–	
Connection of round conductors mm ²		35 - 120	35 - 120	35 - 120	–	–	
Clamping area for laminated copper bars (W x H) mm		18.5 x 15.5	18.5 x 15.5	18.5 x 15.5	–	–	
For switchgear make (model)		ABB (S1, S2, T1, T2, XT1, XT2) Allen Bradley (140-CMN) Eaton (NZM1, BZM B1) GE (FD160) Legrand (DPX 125, DPX 160) OEZ (BC160N) Schneider Electric (NS80, NSC100) Schrack (MC1) Siemens (3RV13 53, 3VT1, 3VA10, 3VA11) Terasaki (E125, S125)	ABB (S1, S2, T1, T2, XT1, XT2) Allen Bradley (140-CMN) Eaton (NZM1, BZM B1) GE (FD160) Legrand (DPX 125, DPX 160) OEZ (BC160N) Schneider Electric (NS80, NSC100) Schrack (MC1) Siemens (3RV13 53, 3VT1, 3VA10, 3VA11) Terasaki (E125, S125)	ABB (S3, T3, T4/320 A, T3 UL, T4 UL, XT3, XT4) Allen Bradley (140U-J) Eaton (NZM2, NZM2 UL, BZM B2) GE (FE160, FE250, FD160) Legrand (DPX 250) Mitsubishi (NF125-SGW/HGW, NF160-SGW/HGW) OEZ (BD250N, BD250S) Schneider Electric (NS(X)100, NS(X)160, NS(X)250, GV7, NSF150, NSF250) Schrack (MC2) Siemens (VL150(X) UL, VL160(X), VL250, VL250 UL, 3RV10 63, 3RV13 63, 3RV13 64, 3VT2, 3VA12/20/21/22, 3VA52/61/62) Terasaki (H125, L125, H160, L160, S160, E250, H250, L250)	ABB (S3, T3, T4/320 A, T3 UL, T4 UL, XT3, XT4) Allen Bradley (140U-J) Eaton (NZM2, NZM2 UL, BZM B2) GE (FE160, FE250, FD160) Legrand (DPX 250) Mitsubishi (NF125-SGW/HGW, NF160-SGW/HGW) OEZ (BD250N, BD250S) Schneider Electric (NS(X)100, NS(X)160, NS(X)250, GV7, NSF150, NSF250) Schrack (MC2) Siemens (VL150(X) UL, VL160(X), VL250, VL250 UL, 3RV10 63, 3RV13 63, 3RV13 64, 3VT2, 3VA12/20/21/22, 3VA52/61/62) Terasaki (H125, L125, H160, L160, S160, E250, H250, L250)	ABB (S3, T3, T4/320 A, T3 UL, T4 UL, XT3, XT4) Allen Bradley (140U-J) Eaton (NZM2, NZM2 UL, BZM B2) GE (FE160, FE250, FD160) Legrand (DPX 250) Mitsubishi (NF125-SGW/HGW, NF160-SGW/HGW) OEZ (BD250N, BD250S) Schneider Electric (NS(X)100, NS(X)160, NS(X)250, GV7, NSF150, NSF250) Schrack (MC2) Siemens (VL150(X) UL, VL160(X), VL250, VL250 UL, 3RV10 63, 3RV13 63, 3RV13 64, 3VT2, 3VA12/20/21/22, 3VA52/61/62) Terasaki (H125, L125, H160, L160, S160, E250, H250, L250)	
Width mm		90	90	105	105	105	
Height mm		215	215	240	240	240	
Approvals		–	–	UL	UL	UL	
For bar systems with centre-to-centre spacing mm		60	60	60	60	60	
For bar thickness mm		5/10	5/10	5/10	5/10	5/10	
Model No.	1 pc(s).	9342.500	9342.510	9342.610	9345.600	9345.610	
Product-specific scope of supply							
Terminal cover		■	■	■	–	–	
Sliding blocks		■	■	■	■	■	
Connection straps		–	–	–	■	■	
Accessories							
Support rail 35 x 15 mm		–	–	–	–	–	
Connection bracket	3 pc(s).	9342.570	9342.570	–	–	–	355
Insert strip		–	–	–	–	–	

Circuit-breaker component adaptors

Rated current max. 400 – 630 A, 3-pole

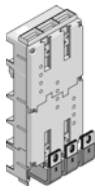
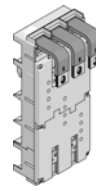
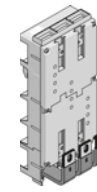
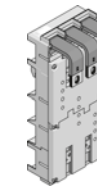
						
Rated current max. A	Packs of	400	400	630	630	Page
Rated operating voltage V, ~		690, 3~	690, 3~	690, 3~	690, 3~	
Number of poles		3-pole	3-pole	3-pole	3-pole	
Cable outlet		Top	Bottom	Top	Bottom	
Type of connection		-	-	-	-	
Connection of round conductors		-	-	-	-	
Clamping area for laminated copper bars (W x H)		-	-	-	-	
When using the Siemens VL630 switchgear, insert strip 9342.720 is additionally required		-	-	■	■	
For switchgear make (model)		Eaton (NZM3, NZM3 UL/400 A) GE (FG400) Mitsubishi (NF400-SEW/HEW/REW) Schneider Electric (NS(X)400, NSJ400) Schrack (MC3) Siemens (VL400, VL400X UL, VL400 UL, 3VA23, 3VA63) Terasaki (E400, S400, H400, L400)	Eaton (NZM3, NZM3 UL/400 A) GE (FG400) Mitsubishi (NF400-SEW/HEW/REW) Schneider Electric (NS(X)400, NSJ400) Schrack (MC3) Siemens (VL400, VL400X UL, VL400 UL, 3VA23, 3VA63) Terasaki (E400, S400, H400, L400)	ABB (S5, T5, T5 UL) Allen Bradley (140U-L) Eaton (NZM3, NZM3 UL/630 A) GE (FG630) Legrand (DPX 630) Mitsubishi (NF630-SEW/HEW/REW) OEZ (BH630N, BH630S) Schneider Electric (NS(X)630, NSJ600) Schrack (MC3) Siemens (VL630, 3VA24, 3VT3, 3V10 73, 3RV13 73, 3RV13 74, 3VA64) Terasaki (E630, S630)	ABB (S5, T5, T5 UL) Allen Bradley (140U-L) Eaton (NZM3, NZM3 UL/630 A) GE (FG630) Legrand (DPX 630) Mitsubishi (NF630-SEW/HEW/REW) OEZ (BH630N, BH630S) Schneider Electric (NS(X)630, NSJ600) Schrack (MC3) Siemens (VL630, 3VA24, 3VT3, 3V10 73, 3RV13 73, 3RV13 74, 3VA64) Terasaki (E630, S630)	
Width mm		140	140	140	140	
Height mm		345	345	345	345	
Approvals		UL	UL	UL	UL	
For bar systems with centre-to-centre spacing mm		60	60	60	60	
For bar thickness mm		5/10	5/10	5/10	5/10	
Model No.	1 pc(s).	9345.720	9345.730	9345.700	9345.710	
Product-specific scope of supply						
Connection straps		■	■	■	■	
Sliding blocks		■	■	■	■	
Accessories						
Support rail 35 x 15 mm		-	-	-	-	
Connection bracket		-	-	-	-	
Insert strip	4 pc(s).	9342.720	9342.720	9342.720	9342.720	353

Circuit-breaker component adaptors



Busbar system Page 300 Connection adaptors Page 304

Material:

- Polyamide
- Fire protection corresponding to UL 94-V0

Colour:

- RAL 7035

Note:

- Cable outlet: Switch outlet or as outgoing cable from the switchgear
- The technical data may vary for UL applications

Rated current max. 160 – 250 A, 4-pole

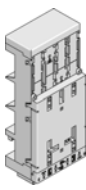
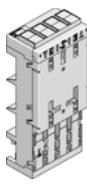
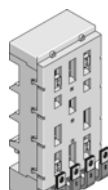
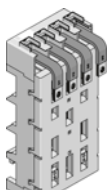
						
Rated current max. A	Packs of	160	160	250	250	Page
Rated operating voltage V, ~		690, 4~	690, 4~	690, 4~	690, 4~	
Number of poles		4-pole	4-pole	4-pole	4-pole	
Cable outlet		Top	Bottom	Top	Bottom	
Type of connection		Box terminal	Box terminal	-	-	
Connection of round conductors mm ²		35 - 120	35 - 120	-	-	
Clamping area for laminated copper bars (W x H) mm		18.5 x 15.5	18.5 x 15.5	-	-	
For switchgear make (model)		ABB (T1, T2, XT1, XT2) Eaton (NZM1-4/125 A, BZM E1-4/100 A) Schneider Electric (NSC100) Schrack (MC1) Siemens (3VA10, 3VA11)	ABB (T1, T2, XT1, XT2) Eaton (NZM1-4/125 A, BZM E1-4/100 A) Schneider Electric (NSC100) Schrack (MC1) Siemens (3VA10, 3VA11)	ABB (T3S, XT3) Eaton (NZM2-4/250 A) Schneider Electric (NS(X)100, NS(X)160, NS(X)250) Schrack (MC2) Siemens (VL160X, VL160, VL250, 3RV10 63, 3VA12/20/21/22, 3VA61/62)	ABB (T3S, XT3) Eaton (NZM2-4/250 A) Schneider Electric (NS(X)100, NS(X)160, NS(X)250) Schrack (MC2) Siemens (VL160X, VL160, VL250, 3RV10 63, 3VA12/20/21/22, 3VA61/62)	
Width mm		120	120	140	140	
Height mm		277	277	310	310	
Approvals		UL	UL	-	-	
For bar systems with centre-to-centre spacing mm		60	60	60	60	
For bar thickness mm		5/10	5/10	5/10	5/10	
Model No.	1 pc(s).	9342.504	9342.514	9345.604	9345.614	
Product-specific scope of supply						
Terminal cover		■	■	-	-	
Sliding blocks		■	■	■	■	
Connection straps		-	-	■	■	

Circuit-breaker component adaptors

Rated current max. 500 A, 4-pole

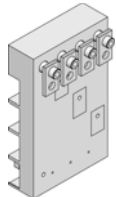
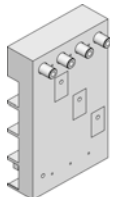
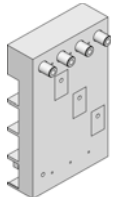
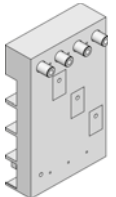
						
Rated current max. A	Packs of	500	500	500	500	Page
Rated operating voltage V, ~		690, 4~	690, 4~	690, 4~	690, 4~	
Number of poles		4-pole	4-pole	4-pole	4-pole	
Cable outlet		Bottom	Bottom	Bottom	Bottom	
Type of connection		-	-	-	-	
Connection of round conductors		-	-	-	-	
Clamping area for laminated copper bars (W x H)		-	-	-	-	
For switchgear make (model)		ABB (Tmax T5)	Schneider Electric (NS(X)400, NS(X)630)	Eaton (NZM3-4-XKR130)	Siemens (VL400)	
Width mm		185	185	185	185	
Height mm		300	300	300	300	
Approvals		-	-	-	-	
For bar systems with centre-to-centre spacing mm		60	60	60	60	
For bar thickness mm		5/10	5/10	5/10	5/10	
Model No.	1 pc(s).	9345.704	9345.714	9345.724	9345.734	
Product-specific scope of supply						
Copper spacer roll		■	■	■	■	
Connection screws		■	■	■	■	
Contact plates		■	-	-	-	

Rittal – The System.



VX25 Power Engineering

see page 446

OM adaptors with connection cables

Switchgear assignment

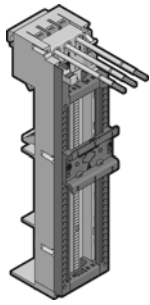

For make/model

ABB													Eaton																						
Circuit-breaker				Starter				Reversing starter				Soft starter	Circuit-breaker				Starter				Reversing starter	Soft starter													
MS 116/132																																			
MS 325																																			
MS 450/451																																			
MS 495/496/497																																			
MS 116 + AF09, AF12, AF16																																			
MS 132 + AF09, AF12, AF16, AF26, AF30, AF38																																			
MS 450 + A40, A50																																			
MS 116 + AF09, AF12, AF16																																			
MS 132 + AF09, AF12, AF16, AF26, AF30, AF38																																			
MS 450 + A40, A50																																			
MS 116 + PSR3, PSR6, PSR9, PSR12, PSR16, PSR25																																			
MS 325 + PSR25																																			
MS 450 + PSR30																																			
PKZM0																																			
PKZM01																																			
PKZM4																																			
PKE12																																			
PKE32																																			
PKE65																																			
MSC-D + M7 - M15																																			
MSC-D + M17 - M32																																			
PKZM4 + DILM 17-65																																			
MSC - DE ... M7 - M12																																			
MSC - DE ... M17 - M32																																			
PKE 65 + DILM 65																																			
MSC - R ... M7 - M12																																			
MSC - R ... M17 - M32																																			
PKE 65 + DILM 65																																			
PKE 12, PKE 32 + DS7-340																																			
PKZ0 + DS7-340																																			

Construction width

Construction width

Model No.	Version	Required quantity (pieces)													Required quantity (pieces)																				
		45	54	55	70	45	45	70	90	90	140	45	45	55	45	45	55	45	45	55	90	90	110	45	45										
9340.340	OM adaptor 25 A, AWG 12, W = 45 mm	1																																	
9340.350	OM adaptor 32 A, AWG 10, W = 45 mm					1														1															
9340.370	OM adaptor 25 A, AWG 12, W = 45 mm									1														1											
9340.380	OM adaptor 32 A, AWG 10, W = 45 mm																											1							
9340.390	OM adaptor 32 A, AWG 10, W = 45 mm									1	1	1	1															1	1						
9340.430	OM adaptor 65 A, AWG 6, W = 55 mm			1	1																														
9340.450	OM adaptor 65 A, AWG 6, W = 55 mm									1																						1			
9340.460	OM adaptor 32 A, AWG 10, W = 55 mm		1																																
9340.260	OM support, 45 x 208 mm									1	1																	1	1						
9340.270	OM support, 55 x 272 mm										1																								
9342.860	Support rail TS45D, 35 x 10 mm	1									1																								
9342.870	Support rail TS45D-V, 35 x 10 mm									1																						1			
9340.290	Insert strip, 10 x 208 mm				2					2		3																							
9340.280	Connection pin									3	3	3																3	3						

Power distribution

OM adaptors with connection cables

Switchgear assignment

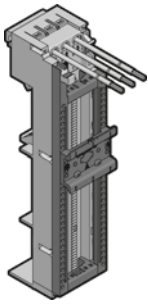

For make/model		Siemens											Schneider Electric																										
		Circuit-breaker			Starter					Reversing starter			Circuit-breaker	Starter					Reversing starter	Soft starter																			
		3RV10 11... (S00)	3RV10 21... (S0)	3RV10 31... (S2)	3RV20 11... (S00) screw terminal	3RV20 21... (S0) screw terminal up to 40 A	3RA11 10... (S00)	3RA11 20... (S0)	3RA11 30... (S2)	3RA21 10... (S00) screw terminal	3RV20 11... (S00 + S0) spring terminal block	3RA21 20... (S00/S0) screw terminal	3RA21 20... (S0) screw terminal	3RA61 20...	3RA12 10... (S00 + S00)	3RA11 20... (S0 + S0)	3RV10 31... + 3RT103... (S2 + S2)	3RA22 10... (S00) screw terminal	3RA22 20... (S0) screw terminal	GV2 - ME (screw terminal and spring terminal block)	GV2 - P	GV2 - RT, LE10, L10	GV3 BIS 65A	GV2 P + LC1D	GV2 ME + LC1D	GV2 - DM102 + LC1D/LC1K	GV2 - DP + LC1D/LC1K	GV3 + LC1D65	LUB 12	LUB 32	GV2 P + LC2D (AC)	GV2 ME + LC2D/LC2K (AC)	GV2 DM + LC2D/LC2K	GV2 DP + LC2D/LC2K	GV2 DP + LC2D/LC2K	GV2 ME + ATS			
		Construction width											Construction width																										
		45	45	55	45	45	45	55	45	45	45	45	45	45	90	100	120	90	90	45	55	45	55	45	45	45	45	45	55	45	45	90	90	90	90	90	45		
ModeNo.	Version	Required quantity (pieces)											Required quantity (pieces)																										
9340.760	OM adaptor 16 A, AWG 12, W = 45 mm										1																												
9340.340	OM adaptor 25 A, AWG 12, W = 45 mm	1	1	1																1		1							1										
9340.350	OM adaptor 32 A, AWG 10, W = 45 mm										1	1						1					1	1	1	1			1	1	1	1	1	1	1	1			
9340.770	OM adaptor 32 A, AWG 10, W = 45 mm												1																										
9340.370	OM adaptor 25 A, AWG 12, W = 45 mm					1	1		1						1	1	1																						
9340.390	OM adaptor 25 A, AWG 12, W = 45 mm																																					1	
9340.430	OM adaptor 65 A, AWG 6, W = 55 mm			1																1		1																	
9340.450	OM adaptor 65 A, AWG 6, W = 55 mm							1									1											1											
9340.720	OM adaptor 40 A, AWG 8, W = 55 mm				1																																		
9340.260	OM support, 45 x 208 mm														1	1		1																	1	1	1	1	1
9340.270	OM support, 55 x 272 mm																	1		1																			
9340.290	Insert strip, 10 x 208 mm																1	1																					
9340.280	Connection pin														3	3	3	3	3																3	3	3	3	3
9342.800	PinBlock, W = 45 mm										1	1											1	1	1	1								2	2	2	2	2	
9342.820	PinBlock PLUS												1										1	1	1	1													

OM adaptors with spring terminal blocks

Switchgear assignment

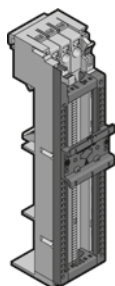

For make/model

		ABB										Eaton																		
		Circuit-breaker				Starter		Reversing starter		Soft starter		Circuit-breaker				Starter			Reversing starter		Soft starter									
		MS 116/132	MS 325	MS 450/451	MS 495/496/497	MS 116 + AF09, AF12, AF16	MS 132 + AF09, AF12, AF16, AF26, AF30, AF38	MS 450 + A40, A50	MS 116 + AF09, AF12, AF16	MS 132 + AF09, AF12, AF16, AF26, AF30, AF38	MS 450 + A40, A50	MS 116 + PSR3, PSR6, PSR9, PSR12, PSR16, PSR25	MS 325 + PSR25	MS 450 + PSR30	PKZM0	PKZM01	PKZM4	PKE12	PKE32	PKE65	MSC-D + M7 - M15	MSC-D + M17 - M32	PKZM4 + DILM 17-65	MSC - DE ... M7 - M12	MSC - DE ... M17 - M32	PKE 65 + DILM 65	MSC - R ... M7 - M12	MSC - R ... M17 - M32	PKE 65 + DILM 65	PKE 12 + DS7-340
Construction width										Construction width																				
45	54	55	70	45	45	70	90	90	140	45	45	55	45	45	55	45	45	55	45	45	55	45	45	55	90	90	110	45	45	45

Model No.	Version	Required quantity (pieces)										Required quantity (pieces)																											
		1										1	1									1	1									1	1						
9340.530	OM adaptor 32 A, 1.5 - 6 mm ² , W = 45 mm	1				1															1	1																	
9340.550	OM adaptor 32 A, 1.5 - 6 mm ² , W = 45 mm								1												1	1					1	1											
9340.560	OM adaptor 32 A, 1.5 - 6 mm ² , W = 45 mm					1		1			1	1												1	1				1	1	1								
9340.660	OM adaptor 32 A, 1.5 - 6 mm ² , W = 55 mm		1																																				
9340.630	OM adaptor 65 A, 2.5 - 16 mm ² , W = 55 mm			1	1										1																								
9340.650	OM adaptor 65 A, 2.5 - 16 mm ² , W = 55 mm						1		1			1											1					1											
9340.260	OM support, 45 x 208 mm							1	1																	1	1												
9340.270	OM support, 55 x 272 mm											1																1											
9340.290	Insert strip, 10 x 208 mm				2			2			3																												
9340.280	Connection pin									3	3	3														3	3	3											
9340.860	Cable set AWG 12	3				3		3			3	3					3				3		3			3		3											
9340.870	Cable set AWG 10		3				3		3				3	3								3		3			3		3	3									
9340.890	Cable set AWG 6			3	3			3				3										3		3			3												
9342.860	Support rail TS45D, 35 x 10 mm	1																																					
9342.930	Support rail TS55D, 35 x 10 mm								1																														

Power distribution

OM adaptors with spring terminal blocks

Switchgear assignment

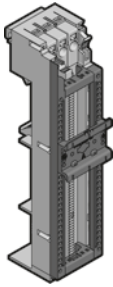

For make/model		Siemens												Schneider Electric																						
		Circuit-breaker				Starter				Reversing starter				Circuit-breaker		Starter				Reversing starter		Soft starter														
		3RV10 11... (S00)	3RV10 21... (S0)	3RV10 31... (S2)	3RV20 11... (S00) screw terminal	3RV20 21... (S0) screw terminal up to 40 A	3RA11 10... (S00)	3RA11 20... (S0)	3RA11 30... (S2)	3RA21 10... (S00) screw terminal	3RA21 20... (S00/S0) screw terminal	3RA21 20... (S0) screw terminal	3RA12 10... (S00 + S00)	3RA11 20... (S0 + S0)	3RV10 31... + 3RT103... (S2 + S2)	3RA22 10... (S00) screw terminal	3RA22 20... (S0) screw terminal	GV2 - ME (screw terminal and spring terminal block)	GV2 - P	GV2 - RT, LE10, L10	GV3 BIS 65A	GV2 P + LC1D	GV2 ME + LC1D	GV2 - DM102 + LC1D/LC1K	GV2 - DP + LC1D/LC1K	GV3 + LC1D65	LUB 12	LUB 32	GV2 P + LC2D (AC)	GV2 ME + LC2D/LC2K (AC)	GV2 DM + LC2D/LC2K	GV2 DP + LC2D/LC2K	GV2 ME + ATS			
		Construction width												Construction width																						
		45	45	55	45	45	45	55	45	45	45	45	90	100	120	90	90	45	55	45	55	45	45	45	45	55	45	45	90	90	90	90	45			
Model No.	Version	Required quantity (pieces)												Required quantity (pieces)																						
9340.530	OM adaptor 32 A, 1.5 - 6 mm ² , W = 45 mm	1	1		1	1												1	1								1	1								
9340.550	OM adaptor 32 A, 1.5 - 6 mm ² , W = 45 mm						1	1		1	1	1	1	1	1	1							1	1	1	1			1	1	1	1				
9340.560	OM adaptor 32 A, 1.5 - 6 mm ² , W = 45 mm																																		1	
9340.630	OM adaptor 65 A, 2.5 - 16 mm ² , W = 55 mm			1														1	1																	
9340.650	OM adaptor 65 A, 2.5 - 16 mm ² , W = 55 mm							1							1										1											
9340.260	OM support, 45 x 208 mm												1	1		1	1												1							
9340.270	OM support, 55 x 272 mm														1																					
9340.290	Insert strip, 10 x 208 mm														1																					
9340.280	Connection pin												3	3	3														3	3	3	3				
9340.860	Cable set AWG 12	3			3		3		3	3	3	3			3											3										
9340.870	Cable set AWG 10		3				3						3		3	3	3					3	3	3	3		3	3	3	3	3				3	
9340.880	Cable set AWG 8				3																															
9340.890	Cable set AWG 6			3			3							3				3	3						3											
9342.820	PinBlock PLUS																					1			1				1	1	1	1				

Bus-mounting fuse base



Busbar system Page 300 Connection adaptors Page 304 OM adaptors Page 307 Circuit-breaker component adaptors Page 314

Material:

- Bus-mounting fuse base: Fibreglass-reinforced, thermoplastic polyester (PBT)
- Contact hazard protection: Polyamide
- Fire protection corresponding to UL 94-V0

Colour:

- RAL 7035

Note:

- For the use of fuse inserts to EN 60 269-3 (DIN VDE 0636-3)

Design		-	Easy Connect	-	Easy Connect	-	Easy Connect	Page
Fuse inserts		D 02-E 18 (adaptor sleeve)	D 02-E 18 (adaptor sleeve)	D II-E 27 (adaptor screw)	D II-E 27 (adaptor screw)	D III-E 33 (adaptor screw)	D III-E 33 (adaptor screw)	
Rated current max. A		63	63	25	25	63	63	
Rated operating voltage V, ~		400, 3~ 400 (DC)	400, 3~ 400 (DC)	500, 3~ 500 (DC)	500, 3~ 500 (DC)	690, 3~ 690 (DC)	690, 3~ 690 (DC)	
Number of poles		3-pole	3-pole	3-pole	3-pole	3-pole	3-pole	
Type of connection		Box terminal	Box terminal	Box terminal	Box terminal	Box terminal	Box terminal	
Connection of round conductors mm ²		1.5 - 25	1.5 - 16	1.5 - 16	1.5 - 16	1.5 - 25	1.5 - 16	
Width mm		27	41	42	56	57	71	
Height mm		209	251	209	251	209	251	
For bar systems with centre-to-centre spacing mm		60	60	60	60	60	60	
For bar thickness mm		5/10	5/10	5/10	5/10	5/10	5/10	
Model No.		3418.010	3418.040	3427.010	3427.040	3433.010	3433.040	
	Packs of	10 pc(s).	5 pc(s).	10 pc(s).	5 pc(s).	10 pc(s).	5 pc(s).	
Product-specific scope of supply								
Pre-configured element ready for connection including cover plate, contact hazard protection and exterior connection clamps		-	■	-	■	-	■	
Also required								
Contact hazard protection cover plate	10 pc(s).	3418.020	-	3427.020	-	3433.020	-	356
Accessories								
Connection space extender	10 pc(s).	3418.030	-	3427.030	-	3433.030	-	356
Cover, side	10 pc(s).	3093.010	-	3093.020	-	3093.020	-	356

Bus-mounting fuse base D-Switch



Busbar system Page 300 **Connection adaptors** Page 304 **OM adaptors** Page 307 **Circuit-breaker component adaptors** Page 314

Material:

- Polyamide
- Fire protection corresponding to UL 94-V0

Colour:

- Chassis: RAL 7035
- Fuse holder: RAL 7001

Supply includes:

- Retaining springs for D 01 and 10 x 38 mm fuses

Basis of test:

- IEC/DIN EN 60 947-3

Note:

- For the use of fuse inserts to EN 60 269-3 (DIN VDE 0636-3)
- With integral visual fuse monitoring via flashing indicator and operating status display as well as cable routing for conductors up to 6 mm²

Fuse inserts	Packs of	D 01 (with retaining spring) D 02 (with Neozed adaptor sleeve) 10 x 38 (with retaining spring)	Page
Rated operating current max. A		63	
Rated operating voltage V, ~		400, 3~	
Number of poles		3-pole	
Voltage, indicator light V		100 - 400	
Type of connection		Box terminal	
Connection of round conductors mm ²		1.5 - 25	
Width mm		27	
Height mm		226	
For bar systems with centre-to-centre spacing mm		60	
For bar thickness mm		5/10	
Model No.	3 pc(s).	9340.950	
Accessories			
Wiring duct	10 pc(s).	9340.905	356

NH fuse-switch-disconnectors, size 000



Busbar system Page 300 **Connection adaptors** Page 304 **OM adaptors** Page 307 **Circuit-breaker component adaptors** Page 314

Material:

- Fibreglass-reinforced polyamide
- Fire protection corresponding to UL 94-V0
- Contact tracks: Silver-plated hard copper

Colour:

- Chassis: RAL 9011
- Cover: RAL 7035

Basis of test:

- IEC/DIN EN 60 947-3
- DIN EN 60 269-2 (fuse inserts)

Size 000, for mounting plate assembly

Size	Packs of	000	Page
Rated operating current max. A		100	
Rated operating voltage V, ~		690, 3~	
Number of poles		3-pole	
Cable outlet		Top/bottom	
Type of connection		Box terminal	
Connection of round conductors mm ²		1.5 - 50	
Clamping area for laminated copper bars (W x H) mm		10 x 10	
Width mm		89	
Height mm		141.5	
For mounting plate assembly		■	
Model No.	1 pc(s).	3431.000	
Accessories			
Micro-switch	5 pc(s).	3071.000	358

NH fuse-switch-disconnectors, size 000



Busbar system Page 300 **Connection adaptors** Page 304 **OM adaptors** Page 307 **Circuit-breaker component adaptors** Page 314

Material:

- Fibreglass-reinforced polyamide
- Fire protection corresponding to UL 94-V0
- Contact tracks: Silver-plated hard copper

Colour:

- Chassis: RAL 7035
- Cover: RAL 7001

Basis of test:

- IEC/DIN EN 60 947-3
- DIN EN 60 269-2 (fuse inserts)

Size 000

Size	Packs of	000	000	000	Page
Rated operating current max. A		100	100	100	
Rated operating voltage V, ~		690, 3~	690, 3~	690, 3~	
Number of poles		3-pole	3-pole	3-pole	
Cable outlet		Top	Bottom	Bottom	
Type of connection		Box terminal	Box terminal	Box terminal	
Connection of round conductors mm ²		2.5 - 50	2.5 - 50	2.5 - 50	
Width mm		53	53	53	
Height mm		213	213	213	
With electronic fuse monitoring		-	-	■	
For bar systems with centre-to-centre spacing mm		60	60	60	
For bar thickness mm		5/10	5/10	5/10	
Model No.	1 pc(s).	3431.020	3431.030	3431.035	
Accessories					
Micro-switch	5 pc(s).	3071.000	3071.000	3071.000	358

NH fuse-switch-disconnectors, size 00 to 3



Busbar system Page 300 **Connection adaptors** Page 304 **OM adaptors** Page 307 **Circuit-breaker component adaptors** Page 314

Material:

- Polyamide
- Fire protection corresponding to UL 94-V0
- Contact tracks: Electrolytic copper, silver-plated

Colour:

- Chassis: RAL 7035
- Cover: RAL 7035/7001

Basis of test:

- IEC/DIN EN 60 947-3
- DIN EN 60 269-2 (fuse inserts)

Note:

- The technical data may vary for UR applications. Applications to UR only in conjunction with "Special Purpose Fuses".

Size 00

Size	Packs of	00	00	00	00	Page
Rated operating current max. A		160	160	160	160	
Rated operating voltage V, ~		690, 3~	690, 3~	690, 3~	690, 3~	
Number of poles		3-pole	3-pole	3-pole	3-pole	
Cable outlet		Top/bottom	Top/bottom	Top/bottom	Top/bottom	
Type of connection		Box terminal	Screw M8	Box terminal	Screw M8	
Connection of round conductors mm ²		4 - 95	10 - 95	4 - 95	10 - 95	
Connection of sector-shaped conductors		-	-	-	-	
Clamping area for laminated copper bars (W x H) mm		13 x 13	20 x 5	13 x 13	20 x 5	
Width mm		106	106	106	106	
Height mm		194	194	194	194	
Approvals		UR	UR	UR	UR	
For mounting plate assembly		-	-	■	■	
For bar systems with centre-to-centre spacing mm		60	60	-	-	
For bar thickness mm		5/10	5/10	-	-	
Model No.	1 pc(s).	9343.000	9343.010	9344.000	9344.010	
Accessories						
Box terminal		-	-	-	-	
Connection space cover	2 pc(s).	9344.520	9344.520	9344.520	9344.520	357
Arcing chamber		-	-	-	-	
Micro-switch	5 pc(s).	3071.000	3071.000	3071.000	3071.000	358
Laminated copper bar		see page	see page	see page	see page	346
Smart monitoring system	1 pc(s).	9343.070	-	-	-	333

NH fuse-switch-disconnectors, size 00 to 3

Size 1

Size	Packs of	1	1	1	1	Page
Rated operating current max. A		250	250	250	250	
Rated operating voltage V, ~		690, 3~	690, 3~	690, 3~	690, 3~	
Number of poles		3-pole	3-pole	3-pole	3-pole	
Cable outlet		Top/bottom	Top/bottom	Top/bottom	Top/bottom	
Type of connection		Box terminal	Screw M10	Box terminal	Screw M10	
Connection of round conductors mm ²		35 - 150	10 - 150	35 - 150	10 - 150	
Connection of sector-shaped conductors mm ²		50 - 150	–	50 - 150	–	
Clamping area for laminated copper bars (W x H) mm		20 x 3 - 14	32 x 10	20 x 3 - 14	32 x 10	
Width mm		184	184	184	184	
Height mm		298	298	298	298	
Approvals		UR	UR	UR	UR	
For mounting plate assembly		–	–	■	■	
For bar systems with centre-to-centre spacing mm		60	60	–	–	
For bar thickness mm		5/10	5/10	–	–	
Model No.	1 pc(s).	9343.100	9343.110	9344.100	9344.110	
Accessories						
Box terminal	3 pc(s).	–	9344.610	–	9344.610	357
Connection space cover	2 pc(s).	9344.530	9344.530	9344.530	9344.530	357
Arcing chamber	3 pc(s).	9344.680	9344.680	9344.680	9344.680	357
Micro-switch	2 pc(s).	9344.510	9344.510	9344.510	9344.510	358
Laminated copper bar		see page	see page	see page	see page	346
Smart monitoring system	1 pc(s).	9343.170	–	–	–	333

Size 2 – 3

Size	Packs of	2	2	2	3	3	3	Page
Rated operating current max. A		400	400	400	630	630	630	
Rated operating voltage V, ~		690, 3~	690, 3~	690, 3~	690, 3~	690, 3~	690, 3~	
Number of poles		3-pole	3-pole	3-pole	3-pole	3-pole	3-pole	
Cable outlet		Top/bottom	Top/bottom	Top/bottom	Top/bottom	Top/bottom	Top/bottom	
Type of connection		Box terminal	Screw M10	Screw M10	Box terminal	Screw M10	Screw M10	
Connection of round conductors mm ²		95 - 300	10 - 240	10 - 240	95 - 300	10 - 300	10 - 300	
Connection of sector-shaped conductors mm ²		120 - 300	–	–	120 - 300	–	–	
Clamping area for laminated copper bars (W x H) mm		32 x 10 - 20	50 x 10	50 x 10	32 x 10 - 20	50 x 10	50 x 10	
Width mm		210	210	210	250	250	250	
Height mm		298	298	298	298	298	298	
Approvals		UR	UR	UR	UR	UR	UR	
For mounting plate assembly		–	–	■	–	–	■	
For bar systems with centre-to-centre spacing mm		60	60	–	60	60	–	
For bar thickness mm		5/10	5/10	–	5/10	5/10	–	
Model No.	1 pc(s).	9343.200	9343.210	9344.210	9343.300	9343.310	9344.310	
Accessories								
Box terminal	3 pc(s).	–	9344.620	9344.620	–	9344.620	9344.620	357
Connection space cover	2 pc(s).	9344.540	9344.540	9344.540	9344.550	9344.550	9344.550	357
Arcing chamber	3 pc(s).	9344.680	9344.680	9344.680	9344.680	9344.680	9344.680	357
Micro-switch	2 pc(s).	9344.510	9344.510	9344.510	9344.510	9344.510	9344.510	358
Laminated copper bar		see page	see page	see page	see page	see page	see page	346
Smart monitoring system	1 pc(s).	9343.270	–	–	9343.370	–	–	333

NH fuse-switch-disconnectors, size 00 to 3



Busbar system Page 300 **Connection adaptors** Page 304 **OM adaptors** Page 307 **Circuit-breaker component adaptors** Page 314

Material:

- Polyamide
- Fire protection corresponding to UL 94-V0
- Contact tracks: Electrolytic copper, silver-plated

Colour:

- Chassis: RAL 7035
- Cover: RAL 7035/7001

Basis of test:

- IEC/DIN EN 60 947-3
- DIN EN 60 269-2 (fuse inserts)

Size 00, with electronic fuse monitoring

Size	Packs of	00	00	00	00	Page
Rated operating current max. A		160	160	160	160	
Rated operating voltage V, ~		400 - 690, 3~	400 - 690, 3~	400 - 690, 3~	400 - 690, 3~	
Number of poles		3-pole	3-pole	3-pole	3-pole	
Cable outlet		Top/bottom	Top/bottom	Top/bottom	Top/bottom	
Type of connection		Box terminal	Screw M8	Box terminal	Screw M8	
Connection of round conductors mm ²		4 - 95	10 - 95	4 - 95	10 - 95	
Connection of sector-shaped conductors		-	-	-	-	
Clamping area for laminated copper bars (W x H) mm		13 x 13	20 x 5	13 x 13	20 x 5	
Width mm		106	106	106	106	
Height mm		194	194	194	194	
For mounting plate assembly		-	-	■	■	
For bar systems with centre-to-centre spacing mm		60	60	-	-	
For bar thickness mm		5/10	5/10	-	-	
Model No.	1 pc(s).	9343.020	9343.030	9344.020	9344.030	
Accessories						
Box terminal		-	-	-	-	
Connection space cover	2 pc(s).	9344.520	9344.520	9344.520	9344.520	357
Arcing chamber		-	-	-	-	
Micro-switch	5 pc(s).	3071.000	3071.000	3071.000	3071.000	358
Laminated copper bar		see page	see page	see page	see page	346
Smart monitoring system	1 pc(s).	9343.070	-	-	-	333

NH fuse-switch-disconnectors, size 00 to 3

Size 1, with electronic fuse monitoring

Size	Packs of	1	1	1	Page
Rated operating current max. A		250	250	250	
Rated operating voltage V, ~		400 - 690, 3~	400 - 690, 3~	400 - 690, 3~	
Number of poles		3-pole	3-pole	3-pole	
Cable outlet		Top/bottom	Top/bottom	Top/bottom	
Type of connection		Box terminal	Screw M10	Screw M10	
Connection of round conductors mm ²		35 - 150	10 - 150	10 - 150	
Connection of sector-shaped conductors mm ²		50 - 150	–	–	
Clamping area for laminated copper bars (W x H) mm		20 x 3 - 14	32 x 10	32 x 10	
Width mm		184	184	184	
Height mm		298	298	298	
For mounting plate assembly		–	–	■	
For bar systems with centre-to-centre spacing mm		60	60	–	
For bar thickness mm		5/10	5/10	–	
Model No.	1 pc(s).	9343.120	9343.130	9344.130	

Accessories

Box terminal	3 pc(s).	–	9344.610	9344.610	357
Connection space cover	2 pc(s).	9344.530	9344.530	9344.530	357
Arcing chamber	3 pc(s).	9344.680	9344.680	9344.680	357
Micro-switch	2 pc(s).	9344.510	9344.510	9344.510	358
Laminated copper bar		see page	see page	see page	346
Smart monitoring system	1 pc(s).	9343.170	–	–	333

Size 2 – 3, with electronic fuse monitoring

Size	Packs of	2	2	3	3	Page
Rated operating current max. A		400	400	630	630	
Rated operating voltage V, ~		400 - 690, 3~	400 - 690, 3~	400 - 690, 3~	400 - 690, 3~	
Number of poles		3-pole	3-pole	3-pole	3-pole	
Cable outlet		Top/bottom	Top/bottom	Top/bottom	Top/bottom	
Type of connection		Screw M10	Screw M10	Screw M10	Screw M10	
Connection of round conductors mm ²		10 - 240	10 - 240	10 - 300	10 - 300	
Connection of sector-shaped conductors		–	–	–	–	
Clamping area for laminated copper bars (W x H) mm		50 x 10	50 x 10	50 x 10	50 x 10	
Width mm		210	210	250	250	
Height mm		298	298	298	298	
For mounting plate assembly		–	■	–	■	
For bar systems with centre-to-centre spacing mm		60	–	60	–	
For bar thickness mm		5/10	–	5/10	–	
Model No.	1 pc(s).	9343.230	9344.230	9343.330	9344.330	

Accessories

Box terminal	3 pc(s).	9344.620	9344.620	9344.620	9344.620	357
Connection space cover	2 pc(s).	9344.540	9344.540	9344.550	9344.550	357
Arcing chamber	3 pc(s).	9344.680	9344.680	9344.680	9344.680	357
Micro-switch	2 pc(s).	9344.510	9344.510	9344.510	9344.510	358
Laminated copper bar		see page	see page	see page	see page	346
Smart monitoring system		–	–	–	–	

NH fuse-switch-disconnectors, size 00 to 3



Busbar system Page 300 **Connection adaptors** Page 304 **OM adaptors** Page 307 **Circuit-breaker component adaptors** Page 314

Material:

- Polyamide
- Fire protection corresponding to UL 94-V0
- Contact tracks: Electrolytic copper, silver-plated

Colour:

- Chassis: RAL 7035
- Cover: RAL 7035/7001

Basis of test:

- IEC/DIN EN 60 947-3
- DIN EN 60 269-2 (fuse inserts)

Size 00, with electromechanical fuse monitoring

Size	Packs of	00	00	00	00	Page
Rated operating current max. A		160	160	160	160	
Rated operating voltage V, ~		690, 3~	690, 3~	690, 3~	690, 3~	
Number of poles		3-pole	3-pole	3-pole	3-pole	
Cable outlet		Top/bottom	Top/bottom	Top/bottom	Top/bottom	
Type of connection		Box terminal	Screw M8	Box terminal	Screw M8	
Connection of round conductors mm ²		4 - 95	10 - 95	4 - 95	10 - 95	
Connection of sector-shaped conductors		-	-	-	-	
Clamping area for laminated copper bars (W x H) mm		13 x 13	20 x 5	13 x 13	20 x 5	
Width mm		106	106	106	106	
Height mm		194	194	194	194	
For mounting plate assembly		-	-	■	■	
For bar systems with centre-to-centre spacing mm		60	60	-	-	
For bar thickness mm		5/10	5/10	-	-	
Model No.	1 pc(s).	9343.040	9343.050	9344.040	9344.050	
Accessories						
Box terminal		-	-	-	-	
Connection space cover	2 pc(s).	9344.520	9344.520	9344.520	9344.520	357
Arcing chamber		-	-	-	-	
Micro-switch	5 pc(s).	3071.000	3071.000	3071.000	3071.000	358
Laminated copper bar		see page	see page	see page	see page	346
Smart monitoring system	1 pc(s).	9343.070	-	-	-	333

NH fuse-switch-disconnectors, size 00 to 3

Size 1, with electromechanical fuse monitoring

Size	Packs of	1	1	1	Page
Rated operating current max. A		250	250	250	
Rated operating voltage V, ~		690, 3~	690, 3~	690, 3~	
Number of poles		3-pole	3-pole	3-pole	
Cable outlet		Top/bottom	Top/bottom	Top/bottom	
Type of connection		Box terminal	Screw M10	Screw M10	
Connection of round conductors mm ²		35 - 150	10 - 150	10 - 150	
Connection of sector-shaped conductors mm ²		50 - 150	–	–	
Clamping area for laminated copper bars (W x H) mm		20 x 3 - 14	32 x 10	32 x 10	
Width mm		184	184	184	
Height mm		298	298	298	
For mounting plate assembly		–	–	■	
For bar systems with centre-to-centre spacing mm		60	60	–	
For bar thickness mm		5/10	5/10	–	
Model No.	1 pc(s).	9343.140	9343.150	9344.150	

Accessories

Box terminal	3 pc(s).	–	9344.610	9344.610	357
Connection space cover	2 pc(s).	9344.530	9344.530	9344.530	357
Arcing chamber	3 pc(s).	9344.680	9344.680	9344.680	357
Micro-switch	2 pc(s).	9344.510	9344.510	9344.510	358
Laminated copper bar		see page	see page	see page	346
Smart monitoring system	1 pc(s).	9343.170	–	–	333

Size 2 – 3, with electromechanical fuse monitoring

Size	Packs of	2	2	3	3	Page
Rated operating current max. A		400	400	630	630	
Rated operating voltage V, ~		690, 3~	690, 3~	690, 3~	690, 3~	
Number of poles		3-pole	3-pole	3-pole	3-pole	
Cable outlet		Top/bottom	Top/bottom	Top/bottom	Top/bottom	
Type of connection		Screw M10	Screw M10	Screw M10	Screw M10	
Connection of round conductors mm ²		10 - 240	10 - 240	10 - 300	10 - 300	
Connection of sector-shaped conductors		–	–	–	–	
Clamping area for laminated copper bars (W x H) mm		50 x 10	50 x 10	50 x 10	50 x 10	
Width mm		210	210	250	250	
Height mm		298	298	298	298	
For mounting plate assembly		–	■	–	■	
For bar systems with centre-to-centre spacing mm		60	–	60	–	
For bar thickness mm		5/10	–	5/10	–	
Model No.	1 pc(s).	9343.250	9344.250	9343.350	9344.350	

Accessories

Box terminal	3 pc(s).	9344.620	9344.620	9344.620	9344.620	357
Connection space cover	2 pc(s).	9344.540	9344.540	9344.550	9344.550	357
Arcing chamber	3 pc(s).	9344.680	9344.680	9344.680	9344.680	357
Micro-switch	2 pc(s).	9344.510	9344.510	9344.510	9344.510	358
Laminated copper bar		see page	see page	see page	see page	346
Smart monitoring system		–	–	–	–	



NH fuse-switch disconnectors Page 325

Compact measurement unit consisting of measurement data acquisition unit, evaluation electronics, communication module, measurement power supply and flash data memory.

Functions:

- Continuous measurement of energy-related data
- Data logging in CSV format (Excel)
- Individual limit monitoring and alarm function
- May be integrated into the CMC III monitoring system
- Automatic address allocation via CAN bus

Material:

- Polyamide
- Fire protection corresponding to UL 94-V0

Colour:

- RAL 7035

Supply includes:

- NH measurement module
- Connector 2 x 2.5 mm² with preassembled bridge
- USB cable (mini-B connector on micro-B jack)

NH measurement module for NH fuse-switch disconnectors

For size	Packs of	00	1	2	3	Page
To fit Model No.		9343.000/ 9343.020/ 9343.040	9343.100/ 9343.120/ 9343.140	9343.200	9343.300	
Rated operating current max. A		150	250	400	600	
Rated operating voltage V, ~		400, 3~	400, 3~	400, 3~	400, 3~	
Number of poles		3-pole	3-pole	3-pole	3-pole	
Cable outlet		Bottom	Bottom	Bottom	Bottom	
Type of connection		Box terminal	Box terminal	Box terminal	Box terminal	
Connection of round conductors mm ²		4 - 95	35 - 150	95 - 300	95 - 300	
Connection of sector-shaped conductors mm ²		-	50 - 150	120 - 300	120 - 300	
Clamping area for laminated copper bars (W x H) mm		13 x 13	20 x 3 - 14	32 x 10 - 20	32 x 10 - 20	
Width mm		102	170	185	214	
Height mm		108	123	123	123	
Depth mm		68	92	107	107	
Precision class measurement output (voltage/current/power)		0.2 / 1.5 / 2	0.2 / 1.5 / 2	0.2 / 1.5 / 2	0.2 / 1.5 / 2	
Interfaces		2 x CAN bus (RJ45) 2 x Modbus RTU (RJ45) 1 x USB	2 x CAN bus (RJ45) 2 x Modbus RTU (RJ45) 1 x USB	2 x CAN bus (RJ45) 2 x Modbus RTU (RJ45) 1 x USB	2 x CAN bus (RJ45) 2 x Modbus RTU (RJ45) 1 x USB	
Model No.	1 pc(s).	9343.070	9343.170	9343.270	9343.370	

Smart monitoring system

Accessories



LCD display

for monitoring

Functions:

- Illuminated display with more than 50 measurement parameters
- Intuitive configuration of alarm and limit values
- Voltage supply for display via pluggable RJ12 patch cable

Material:

- Polyphenylene ether (PPE)

Colour:

- RAL 9005

Protection category IP to IEC 60 529:

- IP 51 (front)
- IP 41 (enclosure)

Supply includes:

- LCD display
- Modbus RTU cable (RJ12), length: 2 m

Interfaces	1 x Modbus RTU (RJ12)
Operating temperature range	-5 °C...+55 °C
Storage temperature range	-25 °C...+70 °C
Operating humidity range %	5 - 95
Width mm	96
Height mm	96
Depth mm	46
Packs of	1 pc(s).
Model No.	9343.410

**Also required:**

- Power pack, see page 334



Power pack

for LCD display

For mounting on support rails to EN 60 715, 7.5 mm high.

Material:

- Polycarbonate
- Fire protection corresponding to UL 94-V0

Colour:

- RAL 9005

Protection category IP to IEC 60 529:

- IP 20

Supply includes:

- Power pack
- Connector 2 x 2.5 mm²

Interfaces	1 x Modbus RTU (RJ12) 2 x Modbus RTU (RJ45)
Operating temperature range	-5 °C...+55 °C
Storage temperature range	-25 °C...+70 °C
Operating humidity range %	5 - 95
Width mm	71
Height mm	91
Depth mm	61
Rated operating voltage V, Hz	85 - 265 (AC/DC), 50/60
Output current (max.) A	0.42
Output voltage V (DC)	24
Packs of	1 pc(s).
Model No.	9343.400

NH slimline fuse-switch disconnectors



Busbar system Page 300 **Connection adaptors** Page 304 **NH slimline fuse-switch disconnectors 185 mm** Page 374

Material:

- Fibreglass-reinforced polyamide
- Fire protection corresponding to UL 94-V0
- Contact tracks: Silver-plated hard copper

Colour:

- Chassis: RAL 7035
- Cover: RAL 7001
- Handle: RAL 7016

Basis of test:

- IEC/DIN EN 60 947-3
- DIN EN 60 269-2 (fuse inserts)

Size 00

Size	Packs of	00	00	00	00	00	Page
Rated operating current max. A		160	160	160	160	160	
Rated operating voltage V, ~		690, 3~	690, 3~	690, 3~	690, 3~	690, 3~	
Number of poles		3-pole	3-pole	3-pole	3-pole	3-pole	
Cable outlet		Top/bottom	Top/bottom	Top/bottom	Top/bottom	Top/bottom	
Type of connection		Box terminal	Screw M8	Box terminal	Screw M8	Screw M8	
Connection of round conductors mm ²		2.5 - 95	2.5 - 95	2.5 - 95	2.5 - 95	2.5 - 95	
Width mm		50	50	50	50	50	
Height mm		400	400	400	400	400	
For converter installation		-	-	-	-	■	
For bar systems with centre-to-centre spacing mm		60	60	100	100	100	
For bar thickness mm		5/10	5/10	5/10	5/10	5/10	
Model No.	1 pc(s).	9346.000	9346.010	9346.020	9346.030	9346.060	
Product-specific scope of supply							
3 mounting hooks		■	■	■	■	-	
Accessories							
Connection space cover	1 pc(s).	9346.460	9346.460	9346.460	9346.460	9346.460	357
Clamp-type terminal connection	3 pc(s).	-	3592.010	-	3592.010	3592.010	358
Micro-switch	5 pc(s).	9346.400	9346.400	9346.400	9346.400	9346.400	358

NH slimline fuse-switch disconnectors



Busbar system Page 300 Connection adaptors Page 304 NH slimline fuse-switch disconnectors 185 mm Page 374

Material:

- Fibreglass-reinforced polyamide
- Fire protection corresponding to UL 94-V0
- Contact tracks: Silver-plated hard copper

Colour:

- Chassis: RAL 7035
- Cover: RAL 7001
- Handle: RAL 7016

Basis of test:

- IEC/DIN EN 60 947-3
- DIN EN 60 269-2 (fuse inserts)

Size 00, with electronic fuse monitoring

Size	Packs of	00	Page
Rated operating current max. A		160	
Rated operating voltage V, ~		690, 3~	
Number of poles		3-pole	
Cable outlet		Top/bottom	
Type of connection		Screw M8	
Connection of round conductors mm ²		2.5 - 95	
Width mm		50	
Height mm		400	
For bar systems with centre-to-centre spacing mm		60	
For bar thickness mm		5/10	
Model No.	1 pc(s).	9346.015	
Product-specific scope of supply			
3 mounting hooks		■	
Accessories			
Connection space cover	1 pc(s).	9346.460	357
Clamp-type terminal connection	3 pc(s).	3592.010	358
Micro-switch	5 pc(s).	9346.400	358



Busbar system Page 300 **Connection adaptors** Page 304 **OM adaptors** Page 307 **Circuit-breaker component adaptors** Page 314

Material:

- Polyamide
- Fire protection corresponding to UL 94-V0

Colour:

- RAL 7035

Basis of test:

- UL 4248-4

Note:

- Not suitable for accommodating fuses 10 x 38 mm to IEC 60 269-2/-4/-6

Rated operating current max. 30 A

Fuse type (class)	Packs of	CC	Page
Rated operating current max. A		30	
Rated operating voltage V, ~		600, 3~	
Number of poles		3-pole	
Fuse standard		UL 248-4	
Fuse size mm		10 x 38	
Voltage, indicator light V		110 - 600	
Connection of round conductors mm ²		1.5 - 6	
Connection of round conductors		AWG 10 - 16	
Width mm		27	
Height mm		200	
For bar systems with centre-to-centre spacing mm		60	
For bar thickness mm		5/10	
Model No.	4 pc(s).	9345.040	

Fuse holders



Busbar system Page 300 **Busbar connection adaptors** Page 304 **OM adaptors** Page 307 **Circuit-breaker component adaptors** Page 314

Material:

- Polyamide
- Fire protection corresponding to UL 94-V0

Colour:

- RAL 7035

Basis of test:

- UL 4248-1
- UL 4248-4
- UL 4248-8

Note:

- For snap-on mounting on 35 mm (7.5 mm/15 mm high) support rails to DIN EN 60 715 or RiLine component adaptor adaptor combinations (OM adaptors/supports)

Rated operating current max. 30 – 60 A

Fuse type (class)		CC	J	J	Page
Rated operating current max. A		30	30	60	
Rated operating voltage V, ~		600, 3~	600, 3~	600, 3~	
Number of poles		3-pole	3-pole	3-pole	
Fuse standard		UL 248-4	UL 248-8	UL 248-8	
Fuse size mm		10 x 38	21 x 57	27 x 60	
Voltage, indicator light V		110 - 600	110 - 600	110 - 600	
Connection of round conductors mm ²		0.75 - 25	1.5 - 50	2.5 - 50	
Connection of round conductors		AWG 8 - 18	AWG 1 - 18	AWG 1 - 14	
Not suitable for accommodating fuses 10 x 38 mm to IEC 60 269-2/-4/-6		■	-	-	
Width mm		54	108	120	
Height mm		81	115	118	
Model No.		9345.005	9345.015	9345.035	
	Packs of	4 pc(s).	2 pc(s).	2 pc(s).	

Mounting example on 60 mm bar systems

Required accessories		For fuse holder			Page
Designation	Model No.	9345.005	9345.015	9345.035	
OM support	9340.260	-	1 pc(s).	-	313
OM support	9340.270	-	-	1 pc(s).	313
Connection pin	9340.280	-	3 pc(s).	6 pc(s).	354
Insert strip	9340.290	-	1 pc(s).	1 pc(s).	353
OM adaptor	9340.410	-	1 pc(s).	1 pc(s).	309
OM adaptor	9340.460	1 pc(s).	-	-	308
Support rail	9342.880	-	1 pc(s).	-	352
Support rail	9342.950	1 pc(s).	1 pc(s).	2 pc(s).	352



Busbar system Page 300 **Connection adaptors** Page 304 **OM adaptors** Page 307 **Circuit-breaker component adaptors** Page 314

Material:

- Polyamide
- Fire protection corresponding to UL 94-V0
- Contact tracks: Electrolytic copper, silver-plated

Colour:

- Chassis: RAL 7035
- Cover: RAL 7035/7001

Note:

- UL (listed accessory) is met when using the fuse holder on RiLine busbar systems

Standards:

- UL 508

Rated operating current max. 100 – 400 A

Fuse type (class)	Packs of	J	J	J	Page
Rated operating current min. A		61	101	201	
Rated operating current max. A		100	200	400	
Rated operating voltage V, ~		600, 3~	600, 3~	600, 3~	
Number of poles		3-pole	3-pole	3-pole	
Fuse standard		UL 248-8	UL 248-8	UL 248-8	
Fuse size mm		29 x 118	41 x 146	54 x 181	
Cable outlet		Top/bottom	Top/bottom	Top/bottom	
Type of connection		Box terminal	Box terminal	Box terminal	
Connection of round conductors		AWG 2 – MCM 300	AWG 4/0 – MCM 600	AWG 4/0 – MCM 600	
Width mm		184	210	250	
Height mm		288	288	328	
Approvals		UL	UL	UL	
For bar systems with centre-to-centre spacing mm		60	60	60	
For bar thickness mm		5/10	5/10	5/10	
Model No.	1 pc(s).	9345.100	9345.200	9345.400	

RiLine accessories

Busbars/base isolators



Busbar supports

1-pole

Material:

- Polyamide
- Fire protection corresponding to UL 94-V0

Colour:

- RAL 7035

Note:

- Multi-pole systems with 60 mm bar centre distance may be configured by buying the busbar supports

Approvals:

- UL



Also required:

- Busbars E-Cu, see page 342
- PLS special busbars E-Cu, see page 344



Accessories:

- Spacer, see page 341

For busbar mm	12 x 5/10 15 x 5 - 30 x 10	PLS 1600
Note on Model No.	If 12 x 5/10 mm busbars are used, spacer 9340.090 is additionally required	-
PEN/N/PE support	■	■
Rated operating voltage V, ~	1000, 1~ 1500 (DC)	1000, 1~ 1500 (DC)
Number of poles	Single-pole	Single-pole
Product-specific scope of supply	-	Including raised section for stepped configuration of the PLS busbars
Packs of	4 pc(s).	4 pc(s).
Model No.	9340.030	9342.030



Busbar supports

2-pole

Material:

- Polyamide
- Fire protection corresponding to UL 94-V0

Colour:

- RAL 7035



Also required:

- Busbars E-Cu, see page 342

For busbar mm	12 x 5	12 x 5 - 30 x 10
Bar centre distance mm	70	60
PEN/N/PE support	■	■
N/PE support	■	■
Rated operating voltage V, ~	1000, 2~ 1500 (DC)	1000, 2~
Number of poles	2-pole	2-pole
Approvals	-	UL
Packs of	4 pc(s).	4 pc(s).
Model No.	9600.005	9340.040

RiLine accessories

Busbars/base isolators

Spacer

for RiLine busbar supports (flat busbar system)

For adapting 12 x 5 and 12 x 10 mm size busbars.

Material:

- Polyamide
- Fire protection corresponding to UL 94-V0

Colour:

- RAL 7035

To fit Model No.	Packs of	Model No.
9340.000/9340.004/ 9340.010/9340.030	12 pc(s).	9340.090



Base isolator

For configuring busbar systems with any given bar centre distances and for assembling insulated PE or PEN busbars.

Material:

- Duroplastic polyester (UP resin)

Height mm	40	50
Thread	M10	M10
Rated operating voltage kV	1	1
Tensile strength kN	12	13
Torsional strength Nm	75	90
Bending strength kN	6	6
Packs of	6 pc(s).	6 pc(s).
Model No.	3031.000	3032.000



RiLine accessories

Busbars



CUPONAL busbars

Copper-coated aluminium busbars, suitable for configuring busbar systems with busbar supports 9340.000/9340.050.

Material:

- Aluminium
- Copper

Note:

- The rated current is derived at 65 °C bar temperature and 35 °C ambient temperature
- Correction factor diagram to DIN EN 43 671
- May be cut individually to required length

Standards:

- DIN EN 13 601

Short-circuit resistance diagram 9340.000/9340.050

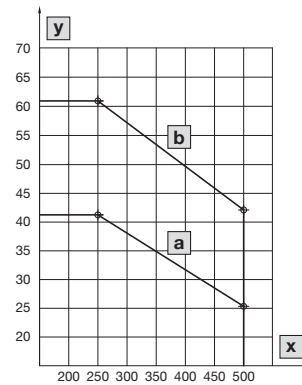

- x** Busbar support spacing (mm)
- y** Ip Surge-current resistance (kA)
- a** CUPONAL 20 x 5/10 mm
- b** CUPONAL 30 x 5/10 mm

Dimensions mm	Length mm	Rated current max. A	Packs of	Model No.
20 x 5	2400	235	6 pc(s).	3582.020
20 x 10	2400	363	3 pc(s).	3585.020
30 x 5	2400	328	6 pc(s).	3584.020
30 x 10	2400	493	3 pc(s).	3586.020

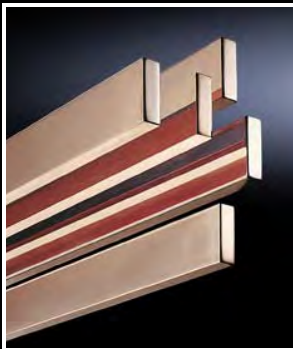

Busbars E-Cu

Material:

- E-Cu F30

Note:

- May be cut individually to required length

Standards:

- DIN EN 13 601

+ Accessories:

- Busbar connector, see page 343
- Busbar cover section, see page 343
- Inserted screw nuts M12, see page 1039

Dimensions mm	Length mm	Approvals	Packs of	Model No.
12 x 5	2400	UL	6 pc(s).	3580.000
15 x 5	2400	UL	6 pc(s).	3581.000
20 x 5	2400	UL	6 pc(s).	3582.000
25 x 5	2400	UL	6 pc(s).	3583.000
30 x 5	2400	UL	6 pc(s).	3584.000
12 x 10	2400	UL	6 pc(s).	3580.100
15 x 10	2400	UL	6 pc(s).	3581.100
20 x 10	2400	UL	3 pc(s).	3585.005
30 x 10	2400	UL	3 pc(s).	3586.005
40 x 10	2400	-	3 pc(s).	3587.000
50 x 10	2400	-	2 pc(s).	3588.005
60 x 10	2400	-	2 pc(s).	3589.005
80 x 10	2400	-	1 pc(s).	3590.005
100 x 10	2400	-	1 pc(s).	3590.015
120 x 10	2400	-	1 pc(s).	3590.020

Busbar cover section

Contact hazard protection by covering the busbars.

Material:

- Thermally modified hard PVC.
- Fire protection corresponding to UL 94-V0

Colour:

- RAL 7035

Note:

- May be cut individually to required length

For busbar mm	Length mm	Approvals	Packs of	Model No.
12/15 x 5	1000	-	4 pc(s).	9350.010
12/15 x 10	1000	-	4 pc(s).	9350.060
12 x 5 - 30 x 10	1000	UR	10 pc(s).	3092.000
40 - 60 x 10	1000	UR	10 pc(s).	3085.000

Busbar connector

For connecting rectangular busbars, no drilling required.

Approvals:

- UL

For busbar mm	Connection type	Material	Packs of	Model No.
12 x 5 - 15 x 10	Single connection	Console: St 37, nickel-plated Contact plate: E-Cu, nickel-plated	3 pc(s).	9350.075
20 x 5 - 30 x 10	Single connection	Top piece: Sheet steel, zinc-plated, passivated Contact plate: E-Cu, silver-plated	3 pc(s).	9320.020
20 x 5 - 30 x 10	Baying connection from enclosure to enclosure	Top piece: Sheet steel, zinc-plated, passivated Contact plate: E-Cu, silver-plated	3 pc(s).	9320.030



RiLine accessories

Busbars



PLS special busbars E-Cu

Material:

- E-Cu

Note:

- May be cut individually to required length

Approvals:

- UL



Accessories:

- PLS busbar connectors, see page 344
- PLS expansion connectors, see page 345

For system PLS 800

For enclosure width mm	Cross-section mm ²	Length mm	Bar thickness mm	Packs of	Model No.
600	300	495	5	3 pc(s).	3524.000
800	300	695	5	3 pc(s).	3525.000
1000	300	895	5	3 pc(s).	3525.010
1200	300	1095	5	3 pc(s).	3526.000
-	300	2400	5	1 pc(s).	3509.000

For system PLS 1600

For enclosure width mm	Cross-section mm ²	Length mm	Bar thickness mm	Packs of	Model No.
600	900	495	10	3 pc(s).	3527.000
800	900	695	10	3 pc(s).	3528.000
1000	900	895	10	3 pc(s).	3528.010
1200	900	1095	10	3 pc(s).	3529.000
-	900	2400	10	1 pc(s).	3516.000

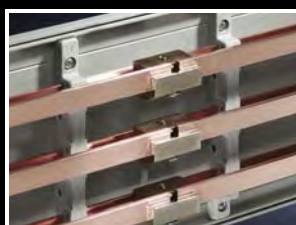
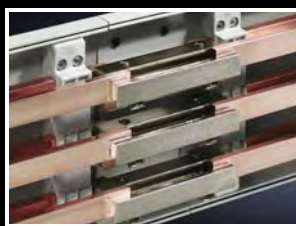

PLS busbar connectors

For connecting the PLS special busbars; no drilling required.

Material:

- E-Cu

Surface finish:

- Nickel-plated

Approvals:

- UL

For system PLS 800

Connection type	Packs of	Model No.
Single connection	3 pc(s).	3504.000
Baying connection from enclosure to enclosure	3 pc(s).	3505.000

For system PLS 1600

Connection type	Packs of	Model No.
Single connection	3 pc(s).	3514.000
Baying connection from enclosure to enclosure	3 pc(s).	3515.000

PLS expansion connectors

For thermal and mechanical compensation when connecting PLS special busbars from enclosure to enclosure.

Material:

- E-Cu

Note:

- At a temperature increase of 30 K, there is an expansion in the length of the busbars by approximately 0.5 mm/m. For this reason, it is advisable to use an expanding connection for thermal compensation in busbar systems with busbar sections > 3600 mm.

Approvals:

- UR

For system	Packs of	Model No.
PLS 800	3 pc(s).	9320.060
PLS 1600	3 pc(s).	9320.070



Also required:

- PLS busbar connectors, see page 344



Assembly instruction:

- Two busbar connectors are needed to fit one expansion connector.



The Copper Workstation CW 120-M is ideal for bending, punching and cutting busbars, from page 639

RiLine accessories

Laminated copper bars



Laminated copper bars

Material:

- Cu lamina High-purity electrolyte copper F20
- Insulation: Highly resistant vinyl compound, elongation 370%, temperature: -30 °C...+105 °C, fire protection corresponding to UL-94 V0, dielectric strength: 20 kV/mm

Note:

- Construction = Number of lamina x lamina width x lamina thickness
- May be cut individually to required length
- The conductor temperature of the laminated copper bar is derived by adding the ambient temperature and the temperature increase together. Example: 3565.005 carrying 180 A, i.e. the temperature increases by 30 K. At an ambient temperature of 35 °C, this produces a resultant conductor temperature of 35 °C + 30 K = 65 °C.



Accessories:

- Universal support, see page 346

Construction mm	Length mm	Rated current (at 70 K) A	Rated current (at 50 K) A	Rated current (at 30 K) A	Packs of	Model No.
6 x 9 x 0.8	2000	285	240	180	1 pc(s).	3565.005
6 x 15.5 x 0.8	2000	415	350	265	1 pc(s).	3568.005
10 x 15.5 x 0.8	2000	575	480	365	1 pc(s).	3569.005
5 x 20 x 1	2000	525	435	330	1 pc(s).	3570.005
5 x 24 x 1	2000	605	510	385	1 pc(s).	3571.005
10 x 24 x 1	2000	920	770	585	1 pc(s).	3572.005
5 x 32 x 1	2000	770	645	485	1 pc(s).	3573.005
10 x 32 x 1	2000	1155	965	730	1 pc(s).	3574.005
5 x 40 x 1	2000	930	780	590	1 pc(s).	3575.005
10 x 40 x 1	2000	1370	1145	865	1 pc(s).	3576.005
5 x 50 x 1	2000	1125	940	710	1 pc(s).	3577.005
10 x 50 x 1	2000	1635	1365	1030	1 pc(s).	3578.005
10 x 63 x 1	2000	1950	1610	1230	1 pc(s).	3579.005



Universal support

for laminated copper bars

For the attachment of laminated copper bars from 5 x 20 x 1 to 10 x 63 x 1 mm.

Material:

- Fibreglass-reinforced, thermoplastic polyester (PBT)
- Fire protection corresponding to UL 94-V0

Colour:

- RAL 7035

Supply includes:

- Assembly parts

Packs of	Model No.
3 pc(s).	3079.000



Accessories:

- Punched rail 23 x 23 mm, see page 994



Universal support

for laminated copper bars

For the attachment of multi-stacked laminated copper bars from 5 x 40 x 1 to 10 x 100 x 1 mm.

Material:

- Fibreglass-reinforced, thermoplastic polyester (PBT)
- Fire protection corresponding to UL 94-V0

Colour:

- RAL 7035

Supply includes:

- Assembly parts

Packs of	Model No.
1 pc(s).	3079.010

Note:

- 1 universal support corresponding to the supply scope shown in the photograph



Accessories:

- C rails 30/15, see page 996

RiLine accessories

Contact hazard protection

Base tray

for RiLine busbar systems

For rear contact hazard protection of the busbar assembly.

Material:

- Thermally modified hard PVC.
- Fire protection corresponding to UL 94-V0

Colour:

- RAL 7035

Note:

- May be cut individually to required length

Approvals:

- UL

For system Flat copper busbars, 3-pole

Length mm	Packs of	Model No.
500	2 pc(s).	9340.100
700	2 pc(s).	9340.110
900	2 pc(s).	9340.120
1100	2 pc(s).	9340.130
2400	1 pc(s).	9340.170

For system Flat copper busbars, 4-pole

Length mm	Packs of	Model No.
1100	2 pc(s).	9340.134

For system PLS 800, 3-pole

Length mm	Packs of	Model No.
500	2 pc(s).	9341.100
700	2 pc(s).	9341.110
900	2 pc(s).	9341.120
1100	2 pc(s).	9341.130
2400	1 pc(s).	9341.170

For system PLS 1600, 3-pole

Length mm	Packs of	Model No.
500	2 pc(s).	9342.100
700	2 pc(s).	9342.110
900	2 pc(s).	9342.120
1100	2 pc(s).	9342.130
2400	1 pc(s).	9342.170

For system PLS 1600, 4-pole

Length mm	Packs of	Model No.
1100	2 pc(s).	9342.134



Power distribution

Base tray infill

for RiLine busbar systems

For rear contact hazard protection when connecting the busbars from enclosure to enclosure.

Material:

- Thermally modified hard PVC.
- Fire protection corresponding to UL 94-V0

Colour:

- RAL 7035

Supply includes:

- Assembly parts

Approvals:

- UL

For system	Length mm	Packs of	Model No.
Flat copper busbars, 3-pole	100	2 pc(s).	9340.140
PLS 800, 3-pole	100	2 pc(s).	9341.140
PLS 1600, 3-pole	100	2 pc(s).	9342.140



RiLine accessories

Contact hazard protection



Cover section

for RiLine busbar systems

For clip-on mounting onto the base tray.

Material:

- Thermally modified hard PVC.
- Fire protection corresponding to UL 94-V0

Colour:

- RAL 7035

Note:

- If the cover section is loaded from the front, the support panel is needed for stability
- May be cut individually to required length

Approvals:

- UL

For system	Length mm	Packs of	Model No.
Flat copper busbars, 3-pole PLS 800, 3-pole PLS 1600, 3-pole	700	2 pc(s).	9340.200
Flat copper busbars, 3-pole PLS 800, 3-pole PLS 1600, 3-pole	1100	2 pc(s).	9340.210
Flat copper busbars, 4-pole PLS 1600, 4-pole	1100	2 pc(s).	9340.214



Also required:

- Base tray, see page 347



Accessories:

- Support panel, see page 348



Support panel

for cover section

To prevent side access to the cover section. The support panel also provides additional stability. Recommended mounting distance \leq 500 mm.

Material:

- Polyamide
- Fire protection corresponding to UL 94-V0

Colour:

- RAL 7035

Approvals:

- UL

For system	Packs of	Model No.
3-pole	5 pc(s).	9340.220
4-pole	5 pc(s).	9340.224



Cross member

for RiLine busbar connections

To comply with the clearances required for "feeder circuits" under UL 508. For flat bar systems with 60 mm bar centre distance and PLS 800/1600.

Material:

- Polyamide
- Fire protection corresponding to UL 94-V0

Colour:

- RAL 7035

Note:

- 2 cross members are required for one busbar connection

Approvals:

- UL

For system	Length mm	Packs of	Model No.
3-pole	160	2 pc(s).	9340.230



Also required:

- Support panel, see page 348

RiLine accessories

Connection systems

Conductor connection clamps

Push-in

Applications:

- For use as busbar pick-off of L, N or PE conductors in switchgear and controlgear, and as a conductor connection clamp in meter boxes.
- For mounting on E-Cu or CUPONAL busbars

Benefits:

- Maintenance-free
- Time-saving top-mounting
- Terminal box with integral label panels
- Universal conductor connection

Functions:

- Fully insulated terminal for tool-free conductor connection
- Conductor is released by the integral release pin

Material:

- Polyamide
- Fire protection corresponding to UL 94-V0

Colour:

- RAL 7042

Basis of test:

- IEC 60 999-1
- IEC 60 947-7-1/-2



For bar thickness mm	Connection of round conductors, single-wire mm ²	Connection of round conductors, multi-wire mm ²	Connection of round conductors, fine wire without wire end ferrule mm ²	Connection of round conductors, fine wire with wire end ferrule mm ²	Packs of	Model No.
5	0.5 - 6	0.5 - 4	0.5 - 4	0.5 - 4	10 pc(s).	3450.505
5	1.5 - 16	1.5 - 16	1.5 - 16	1.5 - 16	10 pc(s).	3451.505
10	0.5 - 6	0.5 - 4	0.5 - 4	0.5 - 4	10 pc(s).	3455.505
10	1.5 - 16	1.5 - 16	1.5 - 16	1.5 - 16	10 pc(s).	3456.505

Conductor connection clamps

For connecting round conductors and laminated copper bars.

Note:

- Wire end ferrules should be used with fine wire conductors

Approvals:

- UR

Accessories:

- Laminated copper bar, see page 346



For bar thickness mm	Connection of round conductors mm ²	Clamping area for laminated copper bars (W x H) mm	Material	Surface finish	Packs of	Model No.
5	1 - 4	-	Sheet steel	Zinc-plated, passivated	15 pc(s).	3450.500
5	2.5 - 16	8 x 8	Sheet steel	Zinc-plated, passivated	15 pc(s).	3451.500
5	16 - 50	10.5 x 11	Sheet steel	Zinc-plated, passivated	15 pc(s).	3452.500
5	35 - 70	16.5 x 15	Sheet steel	Zinc-plated, passivated	15 pc(s).	3453.500
5	70 - 185	22.5 x 20	Sheet steel	Zinc-plated, passivated	15 pc(s).	3454.500
10	1 - 4	-	Sheet steel	Zinc-plated, passivated	15 pc(s).	3455.500
10	2.5 - 16	8 x 8	Sheet steel	Zinc-plated, passivated	15 pc(s).	3456.500
10	16 - 50	10.5 x 11	Sheet steel	Zinc-plated, passivated	15 pc(s).	3457.500
10	35 - 70	16.5 x 15	Sheet steel	Zinc-plated, passivated	15 pc(s).	3458.500
10	70 - 185	22.5 x 20	Sheet steel	Zinc-plated, passivated	15 pc(s).	3459.500
3 - 5	1 - 4	-	Brass	-	15 pc(s).	3550.000
6 - 10	1 - 4	-	Brass	-	15 pc(s).	3555.000

RiLine accessories

Connection systems

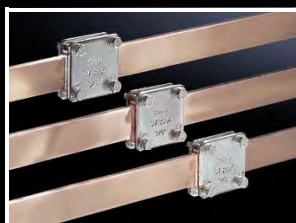

Plate clamps

For connecting laminated copper bars; no drilling required.

Material:

- Sheet steel

Surface finish:

- Zinc-plated, passivated

For busbar mm	Clamping area for laminated copper bars (W x H) mm	Packs of	Model No.
12 x 5 - 30 x 10	34 x 10	3 pc(s).	3554.000
40 x 10	34 x 10	3 pc(s).	3559.000
50 x 10	34 x 10	3 pc(s).	3560.000
50 x 10	54 x 10	3 pc(s).	3562.000
60 x 10	34 x 10	3 pc(s).	3561.000
60 x 10	54 x 10	3 pc(s).	3563.000
80 x 10	65 x 10	3 pc(s).	3460.500



Accessories:

- Laminated copper bar, see page 346



System cover

For conductor connection clamps and plate clamps.

Material:

- ABS
- Fire protection corresponding to UL 94-V0

Colour:

- RAL 7035

Note:

- For 3-pole systems with 60/100 mm bar centre distance
- Only suitable for use with systems without a base tray
- For systems with a base tray, the system covers must be mechanically shortened

Approvals:

- UR

Width mm	Depth mm	Height when mounting on 60 mm busbar systems mm	Height when mounting on 100 mm busbar systems mm	Packs of	Model No.
50	80	230	325	4 pc(s).	3086.000
100	80	230	325	4 pc(s).	3087.000
100	110	230	325	4 pc(s).	3090.000
200	80	230	325	4 pc(s).	3088.000
200	110	230	325	4 pc(s).	3091.000

Connection block

Suitable for busbars 12 x 5 to 30 x 10 mm and PLS 800/1600.

Material:

- Punched section: Polyamide
- Cover: ABS
- Fire protection corresponding to UL 94-V0

Colour:

- RAL 7035

Supply includes:

- 3 terminals including cover

Note:

- When using the terminal on 2-pole busbar systems (SV 9340.040), the terminal must be rotated through 180° for connection to the PE busbar

Approvals:

- UL



Accessories:

- Laminated copper bar, see page 346



Rated current max. A	800	1600
Rated operating voltage V, ~	690, 1~	690, 1~
Rated operating voltage (L1 + L2) V	1000 (DC)	1000 (DC)
Rated operating voltage (L1 + L3) V	1500 (DC)	1500 (DC)
Cable outlet	Top/bottom	Top/bottom
Connection of round conductors, fine wire with wire end ferrule mm ²	95 - 185	-
Connection of round conductors, multi-wire mm ²	95 - 300	-
Clamping area for laminated copper bars with 5 mm bar thickness (W x H) mm	33 x 26	65 x 27
Clamping area for laminated copper bars with 10 mm bar thickness (W x H) mm	33 x 22	65 x 22
Width mm	50	85
Height mm	88	88
Packs of	3 pc(s).	3 pc(s).
Model No.	9342.311	9342.321

RiLine accessories

for OM adaptors/supports/component adaptors



Support rail 35 x 7.5 mm for Mini-PLS component adaptors

Material:

- Sheet steel

Surface finish:

- Zinc-plated

Supply includes:

- Assembly screws and side anti-slip guard

Width mm	Packs of	Model No.
45	10 pc(s).	9320.150
54	10 pc(s).	3548.000



Support rail 35 x 7.5 mm for OM adaptors/supports

Applications:

- For assembly on 55 mm wide OM adaptors/ supports with 10 mm wide insert strips mounted on the right and left
- Arrangement of the mounting hole for central configuration on 55 mm wide adaptor section or support frame

Material:

- Sheet steel

Surface finish:

- Zinc-plated

Supply includes:

- Assembly screws and side anti-slip guard

Width mm	Packs of	Model No.
72	5 pc(s).	9342.980



Support rail 35 x 10 mm for OM adaptors/supports

For attaching to the adaptor section and support frame.

Material:

- Polyamide

Colour:

- RAL 9005

Supply includes:

- Assembly screws

Note:

- UL approval in conjunction with OM adaptors/ supports
- Support rail TS xxD-V only suitable for non-pitch pattern-dependent mounting on support frame

Width mm	With anti-slip guard for motor circuit-breaker	Design	Packs of	Model No.
45	■	TS 45C	5 pc(s).	9342.850
45	-	TS 45D	5 pc(s).	9342.860
45	-	TS 45D-V	5 pc(s).	9342.870
55	■	TS 55C	5 pc(s).	9342.920
55	-	TS 55D	5 pc(s).	9342.930
55	-	TS 55D-V	5 pc(s).	9342.940



Support rail 35 x 15 mm for OM adaptors/supports

For attaching to the adaptor section.

Material:

- Sheet steel

Surface finish:

- Zinc-plated

Supply includes:

- Assembly screws and side anti-slip guard

Width mm	Packs of	Model No.
45	5 pc(s).	9342.880
55	5 pc(s).	9342.950

RiLine accessories

for OM adaptors/supports/component adaptors

Support rail 35 x 15 mm

for Mini-PLS/circuit-breaker component adaptors

Material:

- Sheet steel

Surface finish:

- Zinc-plated

Supply includes:

- Assembly screws and side anti-slip guard

Approvals:

- UR

Width mm	To fit Model No.	Packs of	Model No.
72	9342.400/ 9342.410/ 9629.000	5 pc(s).	9320.120



Insert strip

for Mini-PLS component adaptors

To extend the construction width.

Material:

- ABS

Colour:

- RAL 7035

Approvals:

- UR

Width mm	Packs of	Model No.
9	2 pc(s).	9623.000



Insert strip

for OM adaptors/supports

To extend the construction width in a 10 mm pitch pattern. May be bayed as often as required on both sides. With integral cable duct.

Material:

- Polyamide

Colour:

- RAL 7035

Supply includes:

- 6 connection pins

Approvals:

- UL

Width mm	Packs of	Model No.
10	2 pc(s).	9340.290



Insert strip

for circuit-breaker component adaptors

To extend the construction width from 140 mm to 190 mm.

Material:

- ABS

Colour:

- RAL 7035

Supply includes:

- Connection parts for power circuit-breaker, brand Siemens VL630 (3-pole)

Note:

- 4 pieces are needed to widen a component adaptor

Approvals:

- UL

Width mm	To fit Model No.	Packs of	Model No.
25	9345.700/ 9345.710/ 9345.720/ 9345.730	4 pc(s).	9342.720

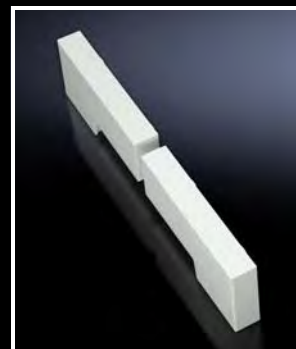

RiLine accessories

for OM adaptors/supports/component adaptors



Connection pin

for OM adaptors/supports

For any required mechanical connection of OM adaptors/supports and insert strip 9340.290.

Material:
– Polyamide

Colour:
– RAL 5010

Approvals:
– UL

Packs of	Model No.
20 pc(s).	9340.280

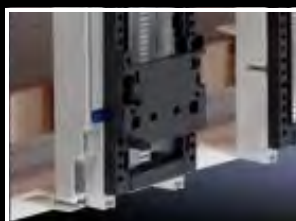

PinBlock

for support frames

For reliable attachment and positioning of the contactor on motor starter combinations. Simple clip-on mounting onto the support frame. Individual vertical positioning is achieved by relocating the PinBlock.

Material:
– Polyamide

Colour:
– RAL 9005

Note:
– UL approval in conjunction with OM adaptors/ supports

For support frame width mm	Packs of	Model No.
45	5 pc(s).	9342.800
55	5 pc(s).	9342.810

+ Accessories:

– PinBlock Plus, see page 354

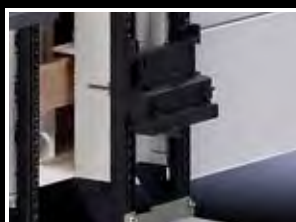

PinBlock Plus

for starters with increased contactor attachment

Mounted by simply clipping onto the PinBlock 9342.800/.810.

Material:
– Polyamide

Colour:
– RAL 9005

Note:
– UL approval in conjunction with OM adaptors/ supports

Packs of	Model No.
5 pc(s).	9342.820



Cable set

for OM adaptors with spring terminal block

Pre-assembled connection cables for individual connection of switchgear, top-mounted on OM adaptors with tension spring clamps.

Material:
– PVC insulation
– Temperature resistant to 105 °C
– Wire ends with ultrasonic wire-end compression at both ends

Note:
– AWG = American Wire Gauge

Cross-section	Length mm	Packs of	Model No.
AWG 14 = 2.08 mm ² ± 2,5 mm ²	140	15 pc(s).	9340.850
AWG 12 = 3.31 mm ² ± 4 mm ²	140	15 pc(s).	9340.860
AWG 10 = 5.26 mm ² ± 6 mm ²	140	15 pc(s).	9340.870
AWG 8 = 8.37 mm ² ± 10 mm ²	140	6 pc(s).	9340.880
AWG 6 = 13.3 mm ² ± 16 mm ²	140	6 pc(s).	9340.890

RiLine accessories

for OM adaptors/supports/component adaptors

Twin cord

for OM adaptors with spring terminal block 2.5 – 16 mm²

Pre-assembled connection cables for individual connection of up to two switchgear units per adaptor.

Material:

- PVC insulation
- Temperature resistant to 105 °C
- Wire ends with ultrasonic wire-end compression at both ends

Note:

- AWG = American Wire Gauge

Cross-section	Length mm	Packs of	Model No.
AWG 10 = 5.26 mm ² ± 6 mm ²	140 250	6 pc(s).	9340.820
AWG 8 = 8.37 mm ² ± 10 mm ²	140 250	6 pc(s).	9340.830



Sliding block

for circuit-breaker component adaptors

For additional locking of circuit-breakers with more than two attachment points.

Colour:

- RAL 7035

Note:

- UL approval in conjunction with circuit-breaker component adaptor

To fit Model No.	With threaded insert	Packs of	Model No.
9342.500/9342.510/ 9342.504/9342.514/ 9342.540/9342.550	M3 M4	6 pc(s).	9342.560
9345.600/9345.610/ 9345.604/9345.614	M4 M5	6 pc(s).	9342.640



Connection bracket

for circuit-breaker component adaptors

Pre-assembled, laminated flat copper for connecting standard, commercially available moulded case circuit-breakers (MCCB).

Material:

- Electrolytic copper F20

Note:

- Universal application for switchgear with a dimensional difference between the mounting level and the upper edge of the contact level of 20 ± 5 mm.

For switchgear make (model)	To fit Model No.	Number of lamina	Membrane width mm	Membrane thickness mm	Packs of	Model No.
ABB (T1, T1 UL, T2, T2 UL) Eaton (NZM1, NZM1 UL, BZM B1) Schneider Electric (NSC100, NSE75, NSE100)	9342.500/ 9342.510/ 9342.540/ 9342.550	6	9	0.8	3 pc(s).	9342.570



RiLine accessories

for bus-mounting fuse bases



Contact hazard protection cover plate

for bus-mounting fuse bases

The cover ensures contact hazard protection from the front, top and below. All-round contact hazard protection (up to IP 2X) in conjunction with the side cover 3093.010/.020.

Material:

- Polyamide
- Fire protection corresponding to UL 94-V0

Colour:

- RAL 7035

To fit Model No.	Fuse inserts	Packs of	Model No.
3418.010	D 02-E 18	10 pc(s).	3418.020
3427.010	D II-E 27	10 pc(s).	3427.020
3433.010	D III-E 33	10 pc(s).	3433.020



Cover, side

for bus-mounting fuse bases

For clip-on mounting onto the cover plate, contact hazard protection.

Material:

- Polyamide
- Fire protection corresponding to UL 94-V0

Colour:

- RAL 7035

To fit Model No.	Fuse inserts	Packs of	Model No.
3418.010	D 02-E 18	10 pc(s).	3093.010
3427.010/ 3433.010	D II-E 27 D III-E 33	10 pc(s).	3093.020



Connection space extender

for bus-mounting fuse bases

Contact hazard protection cover plate including cable duct for side extension of the connection space by 14 mm.

Material:

- Polyamide
- Fire protection corresponding to UL 94-V0

Colour:

- RAL 7035

To fit Model No.	Fuse inserts	Packs of	Model No.
3418.010	D 02-E 18	10 pc(s).	3418.030
3427.010	D II-E 27	10 pc(s).	3427.030
3433.010	D III-E 33	10 pc(s).	3433.030



Wiring duct

for D-Switch bus-mounting fuse base

For safe, shock-hazard-protected routing of connection cables. Also suitable for use as a spacer support.

Material:

- Polyamide
- Fire protection corresponding to UL 94-V0

Colour:

- RAL 7035

Width mm	To fit Model No.	Packs of	Model No.
13.5	9340.950	10 pc(s).	9340.905

RiLine accessories

for NH fuse elements

Box terminal

for NH fuse-switch disconnectors

For direct connection of round and sector-shaped conductors and laminated copper bars. Suitable for NH fuse-switch disconnectors with screw terminal.

Material:

– Cast brass

Surface finish:

– Nickel-plated

For size	Connection of round conductors mm ²	Connection of sector-shaped conductors mm ²	Clamping area for laminated copper bars (W x H) mm	Packs of	Model No.
1	35 - 150	50 - 150	20 x 14	3 pc(s).	9344.610
2/3	95 - 300	120 - 300	32 x 20	3 pc(s).	9344.620



Arcing chamber

for NH fuse-switch disconnectors

To increase switching capacity (utilisation category).

For size	Packs of	Model No.
1 - 3	3 pc(s).	9344.680

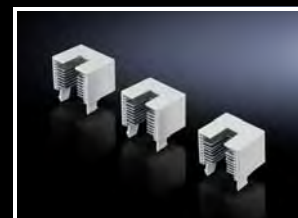

Connection space cover

for NH fuse-switch disconnectors

For extending the contact hazard protection cover, e.g. when using ring terminals with a long collar. Bayable as required at the top and bottom.

Material:

– Polyamide

Colour:

– RAL 7035

For size	Packs of	Model No.
00	2 pc(s).	9344.520
1	2 pc(s).	9344.530
2	2 pc(s).	9344.540
3	2 pc(s).	9344.550



Connection space cover

for NH slimline fuse-switch disconnectors

Extended version for the use of ring terminals with a long collar.

Material:

– Polycarbonate

For size	Packs of	Model No.
00	1 pc(s).	9346.460



RiLine accessories

for NH fuse elements

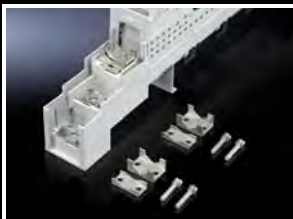

Micro-switch

for NH fuse-switch disconnectors/NH slimline fuse-switch disconnectors (185 mm)

To indicate the switch position of the NH unit (cover).

For size	Rated operating current max. A	Rated operating voltage V	Product-specific scope of supply	Packs of	Model No.
NH fuse-switch disconnectors, size 000/00 NH slimline fuse-switch disconnectors, size 00 - 3 (185 mm)	5	250	–	5 pc(s).	3071.000
NH fuse-switch disconnectors, size 1 - 3	5	250	Including plastic lug for attaching the micro-switch to the disconnectors chassis	2 pc(s).	9344.510

Micro-switch

for NH slimline fuse-switch disconnectors

To indicate the switch position of the NH unit (cover).

For size	Rated operating current max. A	Rated operating voltage V	Packs of	Model No.
00	5	250	5 pc(s).	9346.400

Clamp-type terminal connection

for NH slimline fuse-switch disconnectors

For the connection of round conductors. Suitable for NH slimline fuse-switch disconnectors with screw terminal.

Material:

- Cast brass

Surface finish:

- Nickel-plated

For size	Connection of round conductors mm ²	Packs of	Model No.
00	1.5 - 95	3 pc(s).	3592.010

Push-in conductor connection clamps

Simple, tool-free cable connection, see page 349

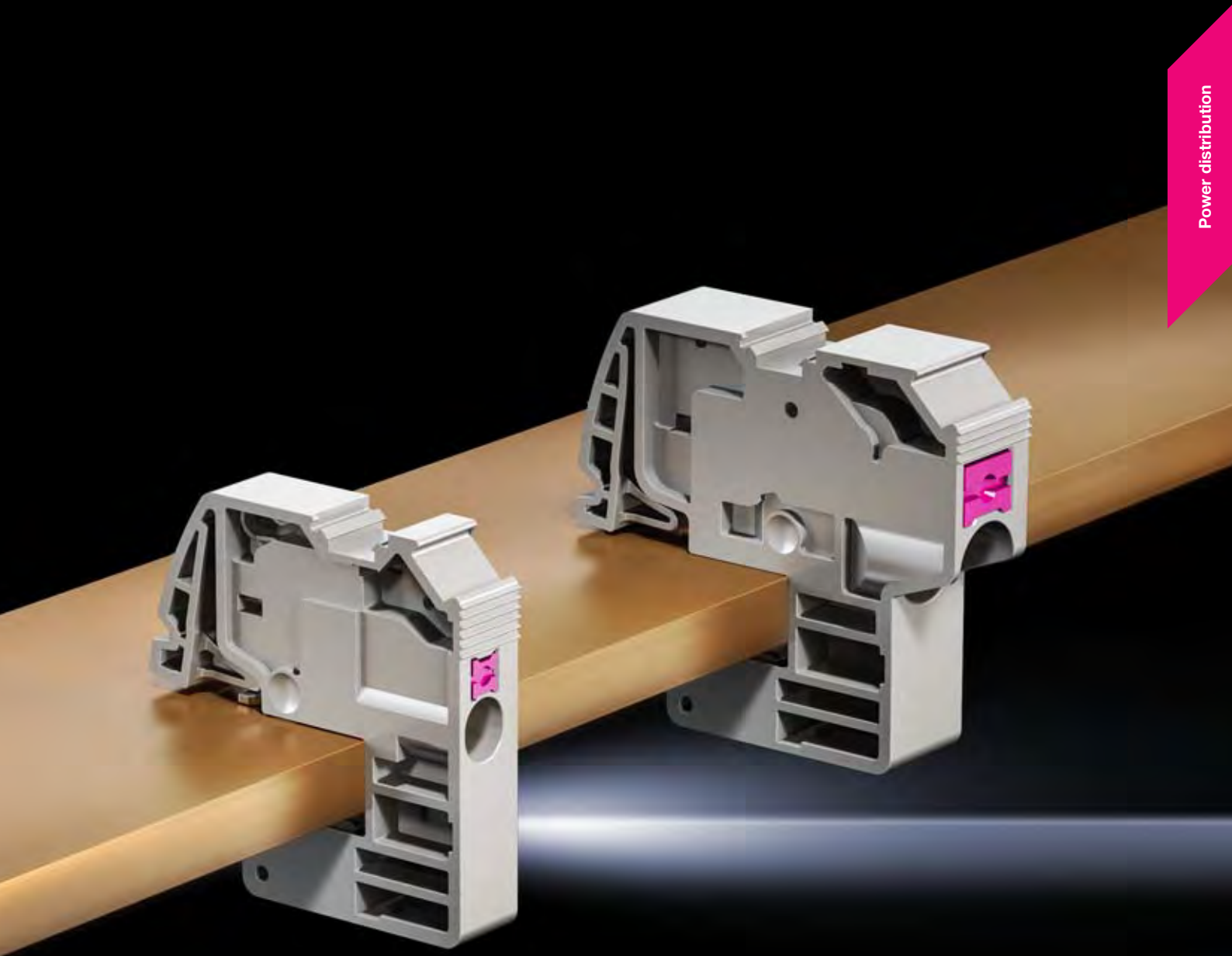

Power distribution

Rittal – The System.

Faster – better – everywhere.



VX25 Ri4Power

Busbar systems

Ri4Power busbar system (185 mm)	368
Busbar systems (100/185/150 mm)	388
Flat-PLS	394
Maxi-PLS	401

Connection system

Flat-PLS	398
Maxi-PLS	403
Accessories – connection components	405
Connection components	406

Cover systems

Form 1	408
Form 2b	409

Compartment configuration

Form 1-4	410
----------------	-----

Fuse-switch disconnecter section

Busbar end supports	415
Cover	415
Ri4Power accessories	417
ISV distribution enclosures	419

Baying enclosure system VX25

Modular enclosures	132
Fuse-switch-disconnector enclosures	134
Distribution enclosures	135
ISV installation kits	420
ISV installation modules	421
ISV accessories	428
Installation accessories for modular front design	926



VX25 Ri4Power system 185 mm – System assembly without drilling

The busbar system is quickly and conveniently installed in the enclosure in just three steps:

- Position the punched section with mounting flange and system attachment in the enclosure
- Secure the busbar assembly
- Clip the cover system into position

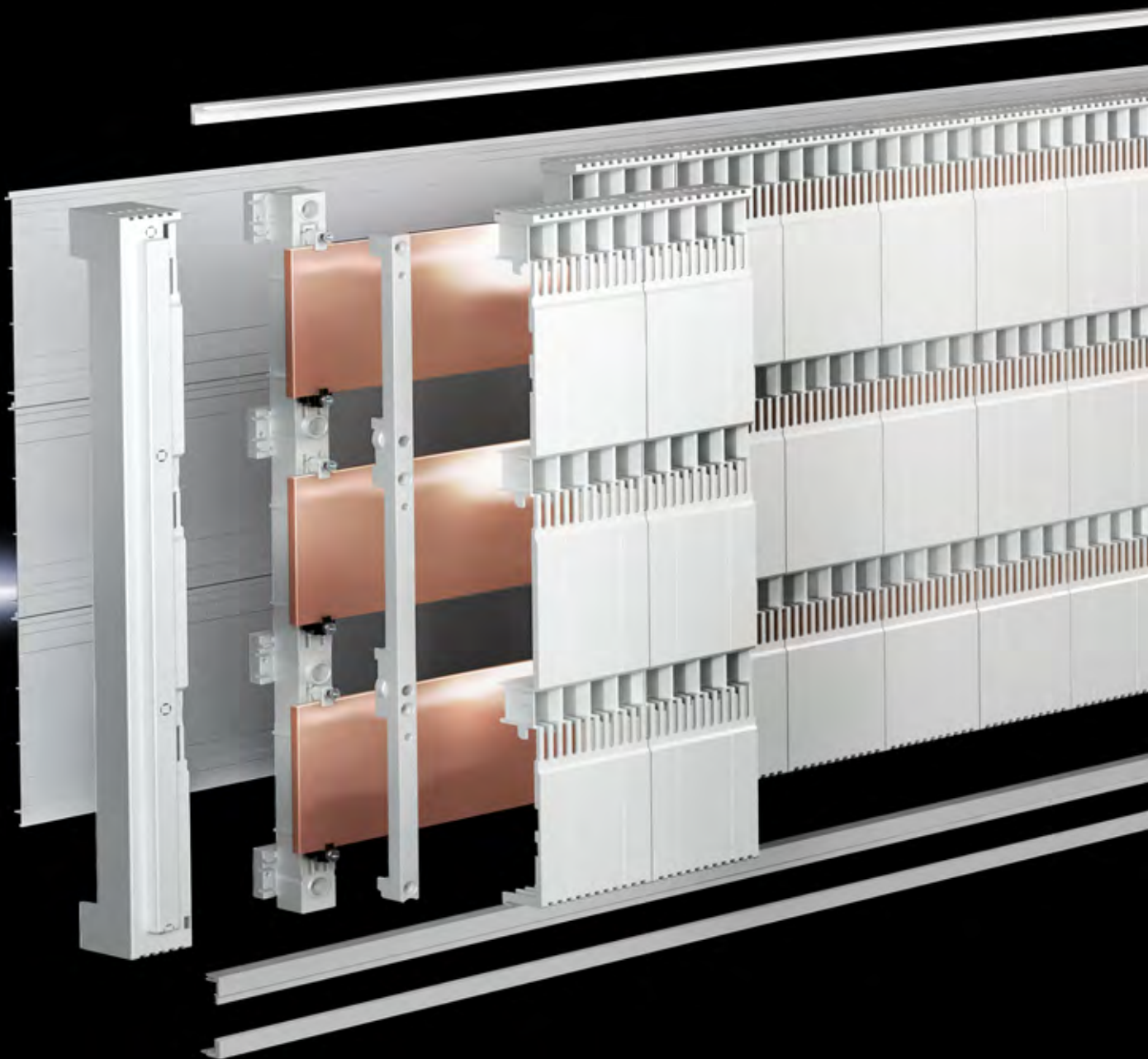

Busbar support

- For busbar dimensions ranging from 40 x 10 to 120 x 10 mm
- The support may be top-mounted with components using the pitch pattern of the cover system
- Rated short-time withstand current I_{cw} up to 50 kA
- Rated busbar currents of up to 2100 A
- Mounting via system attachment in the VX25 baying enclosure system, no drilling required



Power distribution

Cover section

- Contact hazard protection up to IP 2XB (safe from finger-contact)
- Integral busbar shielding to prevent accidental arcing
- Secure positioning of the top-mounting components, thanks to centring device
- New contact system allows components to be top-mounted on the cover section
- Components are easily retrofitted without removing the cover section



Base tray

- For rear contact hazard protection of the busbar assembly
- For optimum all-round contact hazard protection in conjunction with the cover section
- Prepared ready to install, fits VX25 baying enclosure system widths from 600 mm to 1200 mm



The perfect-fit adaptor system

Connection and component adaptors for tested, safe connection at high currents

- For air circuit-breakers up to 630 A and 1600 A
- Direction connection of various conductor types
- No-drill connection system to the busbar



Busbar connection adaptors and connection blocks

- Compact, fast connection of cables and lines
- Suitable for various types of conductor
- With standardised contact hazard protection cover plates

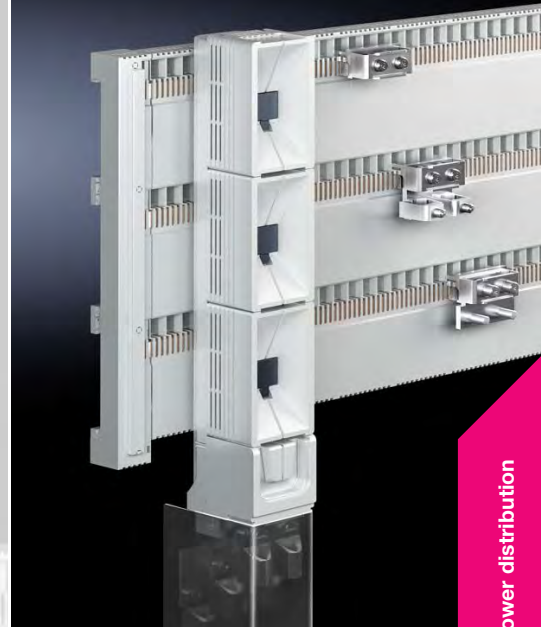

Power distribution

Component adaptors for compact circuit-breakers

- Two sizes up to 630 A and 1600 A
- Variants for clamping or screw attachment
- Make contact without drilling
- Ideal for incoming and outgoing circuits

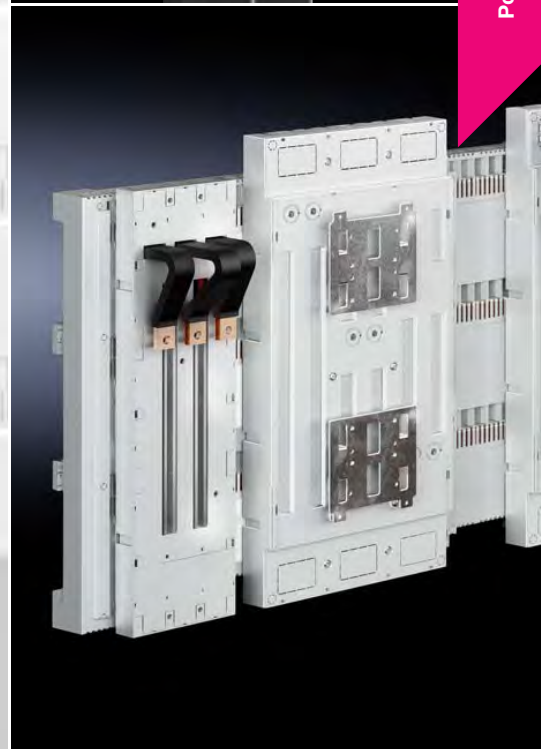

Connector kit and transformer

- Form-fit, prepared for switch brands ABB, Eaton, Schneider Electric, Siemens
- Preassembled connector kits from the adaptor to the circuit-breaker
- Optional integration of a current transformer
- Complete contact hazard protection in the inlet and outlet zones



Fuse elements to suit all situations

The new system of NH slimline fuse-switch disconnectors is based on separate air routing for heat dissipation and targeted removal of switching gases, while the NH slimline switch-disconnectors ensure user-independent disconnection and switching for enhanced safety.

- Simple device assembly
- Safe operation
- Optimum contact hazard protection

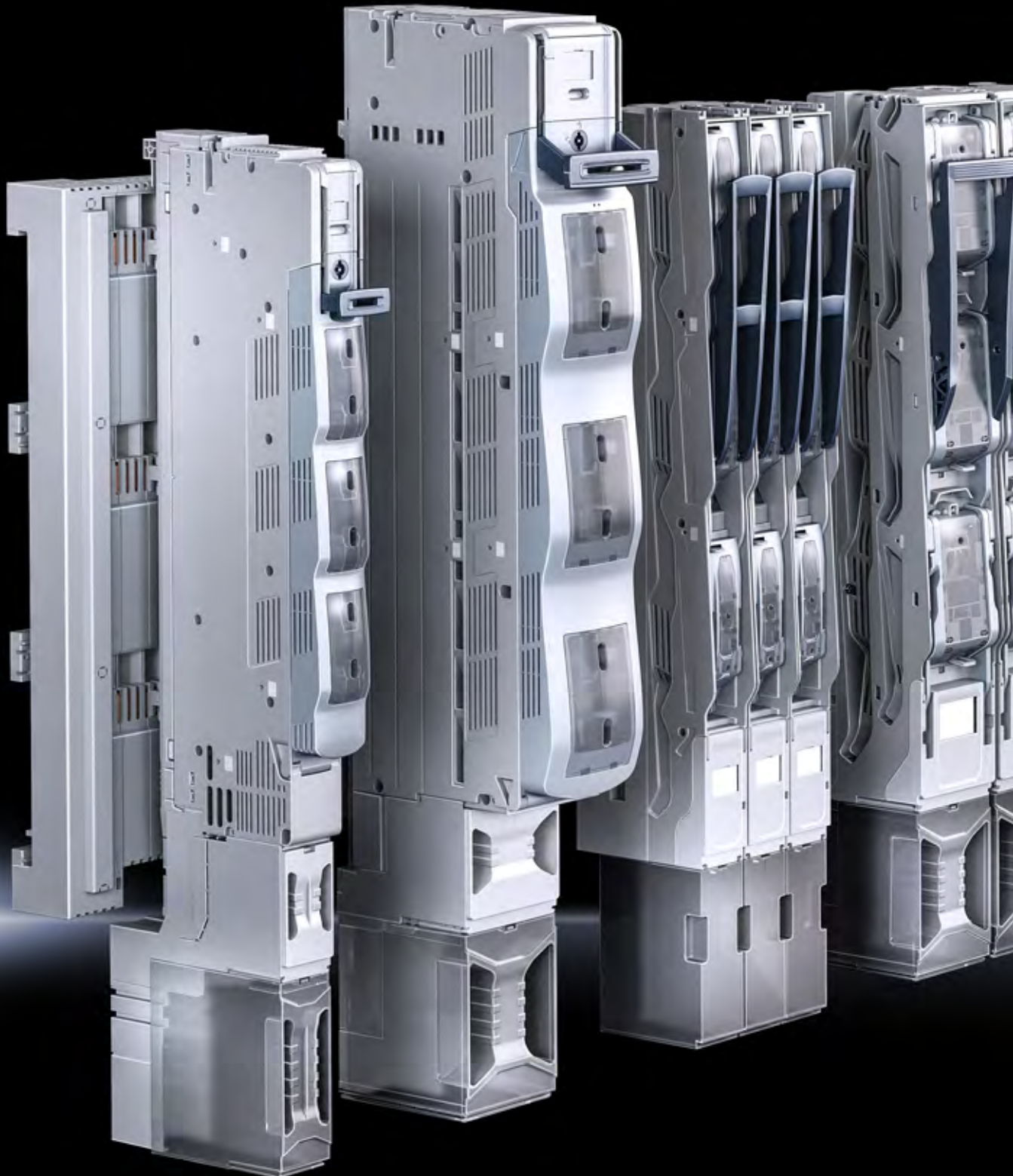

NH slimline fuse-switch disconnectors, sizes 00 to 3

- Single-pole and 3-pole switchable variants
- Symmetrical layout for cable outlet at the top and bottom
- Optional integration of current transformers
- Versions with and without fuse monitoring
- Self-closing voltage testing holes
- Prepared for multiple lead seals
- Hinged terminal cover
- Cascadable connection space extension
- Simple conversion of the bolt or screw connections
- Contact hazard-proof fuse contacts with the top section dismantled
- Optional micro-switch monitoring of the cover switch position

NH slimline switch-disconnectors, size 00 to 3

- Disconnect and switch with one device
- Integral, user-independent quick-break contact ensures safe operation
- User-friendly cable connection from above or below
- Versions with and without fuse monitoring
- Integral switch position display
- No-drill contacting with clamping screw attachment
- Double-break allows de-energised fuse replacement

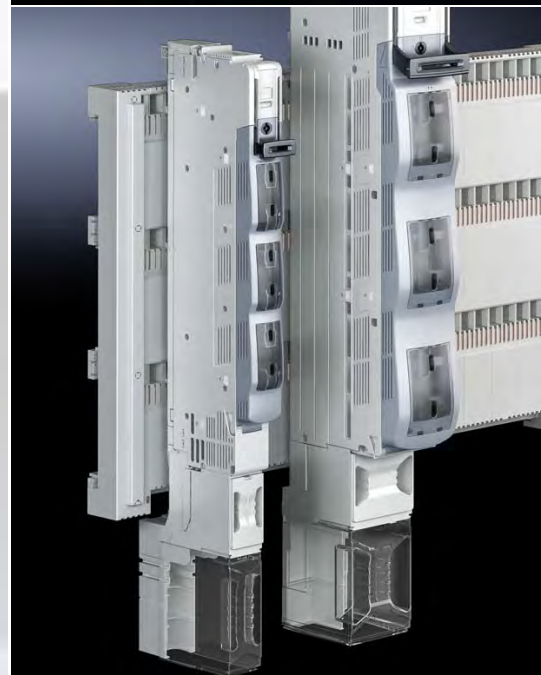
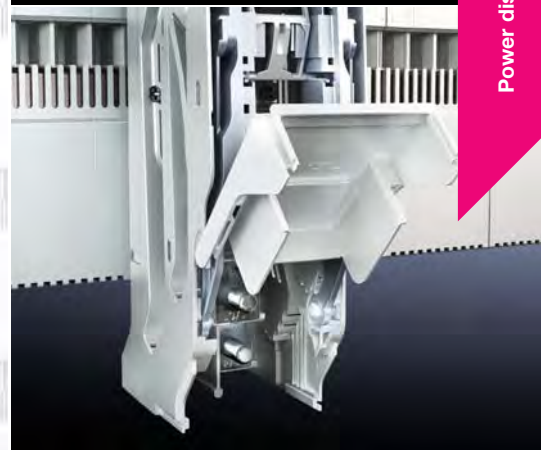
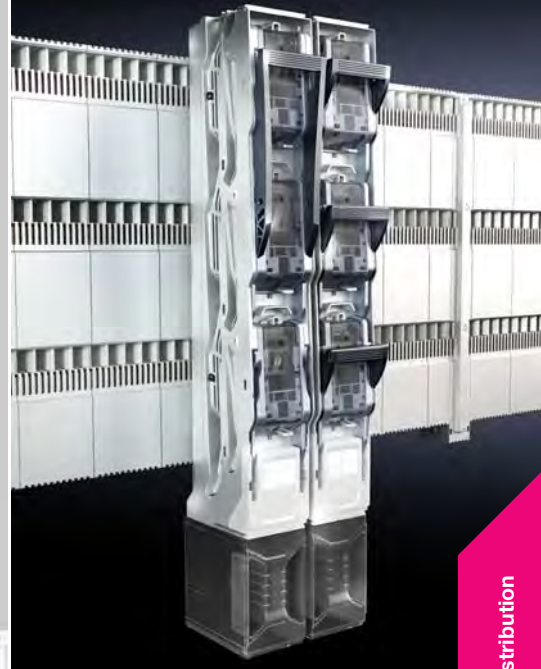

Power distribution

Busbar support (185 mm)



Connection adaptors Page 370 **Connection block** Page 371 **Component adaptors** Page 372 **NH slimline switch-disconnectors** Page 374

Material:

- Polyamide
- Fire protection corresponding to UL 94-V0

Supply includes:

- Including assembly components for contact hazard protection cover (base tray)

Colour:

- RAL 7035

			
Bar centre distance mm	Packs of	185	Page
Rated operating voltage V, ~		1000, 3- 1500 (DC)	
Number of poles		3-pole	
For busbar mm		40 x 10 60 x 10 80 x 10 100 x 10 120 x 10	
Model No.	2 pc(s).	9677.500	
Accessories			
Busbars E-Cu		see page	369
Contact hazard protection cover plate		see page	381
End cover	2 pc(s).	9677.600	380

Busbar system 185 mm

Busbar supports

Note:

Required quantity when using in the enclosure width
 – 600/800 mm: 2 pc(s).
 – 1000/1200 mm: 3 pc(s).



Number of poles	Packs of	3-pole	Page
Bar centre distance mm		185	
Model No.	2 pc(s).	9677.500	368

Busbars E-Cu, length: 2400 mm/bar

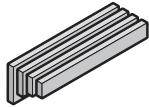

Dimensions mm	Packs of	Model No.	Page
40 x 10	3 pc(s).	3587.000	342
60 x 10	2 pc(s).	3589.005	
80 x 10	1 pc(s).	3590.005	
100 x 10	1 pc(s).	3590.015	
120 x 10	1 pc(s).	3590.020	

Accessories

Busbar connector		see page	380
------------------	--	----------	-----

System attachment

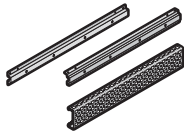

For enclosure width mm	Packs of	Model No.	Page
600	1 pc(s).	9677.511	380
800	1 pc(s).	9677.521	
1000	1 pc(s).	9677.531	
1200	1 pc(s).	9677.541	

Accessories

Punched section with mounting flange, 23 x 64 mm

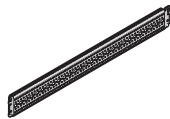

For enclosure depth mm	Packs of	Model No.	Page
500	4 pc(s).	8617.120	991
600	4 pc(s).	8617.130	
800	4 pc(s).	8617.140	

Contact hazard protection

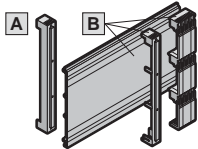

Components	For enclosure width mm	Packs of	Model No.	Page
A End covers l/r	–	2 pc(s).	9677.600	380
B Cover plate, contact hazard protection (cover section, base tray, trim section)	600	1 pc(s).	9677.550	
	800	1 pc(s).	9677.560	
	1000	1 pc(s).	9677.570	
	1200	1 pc(s).	9677.580	

Connection adaptors



Busbar system Page 368 **Connection block** Page 371 **Component adaptors** Page 372 **NH slimline switch-disconnectors** Page 374

Material:

- Chassis: Fibreglass-reinforced polyester
- Fire protection corresponding to UL 94-V0

Note:

- When using components on busbars with contact hazard protection cover, the contact terminal must be used

Colour:

- RAL 7035

Rated current max. 800 – 1400 A

Rated current max. A	Packs of	800	1400	Page
Rated operating voltage V, ~		690, 3~	690, 3~	
Number of poles		3-pole	3-pole	
Cable outlet		Top/bottom	Top/bottom	
Type of connection		Screw M12	Screw M12	
Connection of round conductors mm ²		6 - 240	6 - 300	
Width mm		100	100	
Height mm		665	960	
For bar systems with centre-to-centre spacing mm		185	185	
For bar thickness mm		10	10	
Model No.	1 pc(s).	9677.900	9677.905	
Product-specific scope of supply				
Contact hazard protection cover plate		-	■	
Accessories				
Contact terminal	3 pc(s).	9677.460	9677.460	383
Busbar terminal	3 pc(s).	9677.480	9677.480	384



Busbar system Page 368 **Connection adaptors** Page 370 **Component adaptors** Page 372 **NH slimline switch-disconnectors** Page 374

For connecting cables and laminated copper bars.

Material:

- Sheet steel, zinc-plated
- E-Cu, tin-plated

Rated current max. 1000 – 1600 A

Rated current max. A	Packs of	1000	1600	1600	Page
Rated operating voltage V, ~		690, 1~	690, 1~	690, 1~	
Cable outlet		Top/bottom	Top/bottom	Top/bottom	
Type of connection		Box terminal	-	Ring terminal M12	
Number of connection cables max.		2	-	4	
Connection of round conductors mm ²		185 - 300	-	240	
Clamping area for laminated copper bars (W x H) mm		-	80 x 20	-	
Width mm		98	98	98	
For bar thickness mm		10	10	10	
Model No.	1 pc(s).	9677.915	9677.910	9677.920	

Also required

Contact hazard protection cover plate	1 pc(s).	9677.925	9677.925	9677.925	382
---------------------------------------	----------	----------	----------	----------	-----

Component adaptors



Busbar system Page 368 **Connection adaptors** Page 370 **Connection block** Page 371 **NH slimline switch-disconnectors** Page 374

Material:

- Polyamide
- Fire protection corresponding to UL 94-V0

Colour:

- RAL 7035

Note:

- Cable outlet: Switch outlet or as outgoing cable from the switchgear
- Suitable for the use of switchgear with front screw terminal
- For mounting on busbar systems with or without cover section

Rated current max. 630 – 1600 A, clamping attachment

Rated current max. A	Packs of	630	1000	1600	Page
Rated operating voltage V, ~		690, 3~	690, 3~	690, 3~	
Number of poles		3-pole	3-pole	3-pole	
Installation type		Clamping attachment	Clamping attachment	Clamping attachment	
Cable outlet		Bottom	Bottom	Bottom	
For switchgear make (model)		ABB (Tmax T5) Eaton (NZM3) Schneider Electric (NSX630) Siemens (3VA23, 3VA24, 3VL4)	ABB (Tmax T7 - 800 A/1000 A) Eaton (NZM4 - 800 A/1000 A) Schneider Electric (NS - 800 A/1000 A) Siemens (VL1250/3VL7 - 1000 A)	ABB (Tmax T7 - 1250 A/1600 A) Eaton (NZM4 - 1250 A/1600 A) Schneider Electric (NS - 1250 A/1600 A) Siemens (VL1250/3VL7 - 1250 A, VL1600/3VL8 - 1600 A)	
Width mm		150	300	300	
Height mm		585	652	652	
For bar systems with centre-to-centre spacing mm		185	185	185	
For bar thickness mm		10	10	10	
Model No.	1 pc(s).	9677.770	9677.700	9677.710	
Product-specific scope of supply					
Connection straps		■	-	-	
Also required					
Connector kit		-	see page	see page	382
Contact hazard protection cover plate		-	see page	see page	382



Busbar system Page 368 **Connection adaptors** Page 370 **Connection block** Page 371 **NH slimline switch-disconnectors** Page 374

Material:

- Polyamide
- Fire protection corresponding to UL 94-V0

Colour:

- RAL 7035

Note:

- Cable outlet: Switch outlet or as outgoing cable from the switchgear
- Suitable for the use of switchgear with front screw terminal
- For attaching to busbars with holes. Please ensure that there is no cover section installed in the vicinity of the device.

Rated current max. 630 – 1600 A, screw attachment

Rated current max. A	Packs of	630	1000	1600	Page
Rated operating voltage V, ~		690, 3~	690, 3~	690, 3~	
Number of poles		3-pole	3-pole	3-pole	
Installation type		Screw attachment	Screw attachment	Screw attachment	
Cable outlet		Bottom	Bottom	Bottom	
For switchgear make (model)		ABB (Tmax T5) Eaton (NZM3) Schneider Electric (NSX630) Siemens (3VA23, 3VA24, 3VL4)	ABB (Tmax T7 - 800 A/1000 A) Eaton (NZM4 - 800 A/1000 A) Schneider Electric (NS - 800 A/1000 A) Siemens (VL1250/3VL7 - 1000 A)	ABB (Tmax T7 - 1250 A/1600 A) Eaton (NZM4 - 1250 A/1600 A) Schneider Electric (NS - 1250 A/1600 A) Siemens (VL1250/3VL7 - 1250 A, VL1600/3VL8 - 1600 A)	
Width mm		150	300	300	
Height mm		585	652	652	
For bar systems with centre-to-centre spacing mm		185	185	185	
For bar thickness mm		10	10	10	
Model No.	1 pc(s).	9677.780	9677.705	9677.715	
Product-specific scope of supply					
Connection straps		■	-	-	
Also required					
Connector kit		-	see page	see page	382
Contact hazard protection cover plate		-	see page	see page	382

NH slimline fuse-switch disconnectors



Busbar system Page 368 **Connection adaptors** Page 370 **Connection block** Page 371 **Component adaptors** Page 372

Material:

- Polyamide
- Fire protection corresponding to UL 94-V0
- Contact tracks: Partially silver-plated hard copper

Colour:

- Chassis: RAL 7035
- Cover: RAL 7001
- Handle: RAL 7016

Basis of test:

- IEC/DIN EN 60 947-3
- DIN EN 60 269-2 (fuse inserts)

Note:

- When using components on busbars with contact hazard protection cover, the contact terminal must be used

Size 00 – 3, design single-pole, switchable

Size	Packs of	00	1	2	3	Page
Twin track		-	-	-	-	
Rated operating current max. A		160	250	400	630	
Rated operating voltage V, ~		690, 3~	690, 3~	690, 3~	690, 3~	
Number of poles		3-pole	3-pole	3-pole	3-pole	
Cable outlet		Top/bottom	Top/bottom	Top/bottom	Top/bottom	
Type of connection		Screw M8	Bolt M12	Bolt M12	Bolt M12	
Connection of round conductors mm ²		1.5 - 95	6 - 240	6 - 240	6 - 240	
Width mm		50	100	100	100	
Height mm		670	670	670	670	
For converter installation		■	■	■	■	
For bar systems with centre-to-centre spacing mm		185	185	185	185	
For bar thickness mm		10	10	10	10	
Model No.	1 pc(s).	9677.010	9677.110	9677.210	9677.310	
Accessories						
Connection space cover	1 pc(s).	see page	9677.410	9677.410	9677.410	383
Contact terminal	3 pc(s).	9677.450	9677.460	9677.460	9677.460	383
Busbar terminal	3 pc(s).	9677.470	9677.480	9677.480	9677.480	384
Prism terminal	3 pc(s).	9677.420	-	-	-	384
V connection terminal	3 pc(s).	-	9677.430	9677.430	9677.440	384
Current converter	1 pc(s).	9677.810	see page	see page	see page	385
Cover	5 pc(s).	-	9677.415	9677.415	9677.415	385
Trim strip	2 pc(s).	9677.407	9677.407	9677.407	9677.407	386
Micro-switch	5 pc(s).	3071.000	3071.000	3071.000	3071.000	358

NH slimline fuse-switch disconnectors

Size 00 – 1, design 3-pole, switchable

Size	Packs of	00	00	1	Page
Twin track		–	–	–	
Rated operating current max. A		160	160	250	
Rated operating voltage V, ~		690, 3~	690, 3~	690, 3~	
Number of poles		3-pole	3-pole	3-pole	
Cable outlet		Top/bottom	Top/bottom	Top/bottom	
Type of connection		Screw M8	Box terminal	Bolt M12	
Connection of round conductors mm ²		1.5 - 95	1.5 - 95	6 - 240	
Width mm		50	50	100	
Height mm		670	670	670	
For converter installation		■	■	■	
For bar systems with centre-to-centre spacing mm		185	185	185	
For bar thickness mm		10	10	10	
Model No.	1 pc(s).	9677.000	9677.025	9677.100	
Accessories					
Connection space cover	1 pc(s).	see page	see page	9677.410	383
Contact terminal	3 pc(s).	9677.450	9677.450	9677.460	383
Busbar terminal	3 pc(s).	9677.470	9677.470	9677.480	384
Prism terminal	3 pc(s).	9677.420	–	–	384
V connection terminal	3 pc(s).	–	–	9677.430	384
Current converter	1 pc(s).	9677.810	9677.810	see page	385
Cover	5 pc(s).	–	–	9677.415	385
Trim strip	2 pc(s).	9677.407	9677.407	9677.407	386
Micro-switch	5 pc(s).	3071.000	3071.000	3071.000	358

Size 2 – 3, design 3-pole, switchable

Size	Packs of	2	3	3	Page
Twin track		–	–	■	
Rated operating current max. A		400	630	1250	
Rated operating voltage V, ~		690, 3~	690, 3~	690, 3~	
Number of poles		3-pole	3-pole	3-pole	
Cable outlet		Top/bottom	Top/bottom	Bottom	
Type of connection		Bolt M12	Bolt M12	Bolt M12	
Connection of round conductors mm ²		6 - 240	6 - 240	6 - 240	
Width mm		100	100	200	
Height mm		670	670	670	
For converter installation		■	■	■	
For bar systems with centre-to-centre spacing mm		185	185	185	
For bar thickness mm		10	10	10	
Model No.	1 pc(s).	9677.200	9677.300	9677.340	
Accessories					
Connection space cover	1 pc(s).	9677.410	9677.410	–	383
Contact terminal	3 pc(s).	9677.460	9677.460	9677.460	383
Busbar terminal	3 pc(s).	9677.480	9677.480	9677.480	384
Prism terminal		–	–	–	
V connection terminal	3 pc(s).	9677.430	9677.440	–	384
Current converter		see page	see page	see page	385
Cover	5 pc(s).	9677.415	9677.415	–	385
Trim strip	2 pc(s).	9677.407	9677.407	9677.407	386
Micro-switch	5 pc(s).	3071.000	3071.000	3071.000	358

NH slimline fuse-switch disconnectors



Busbar system Page 368 **Connection adaptors** Page 370 **Connection block** Page 371 **Component adaptors** Page 372

Material:

- Polyamide
- Fire protection corresponding to UL 94-V0
- Contact tracks: Partially silver-plated hard copper

Colour:

- Chassis: RAL 7035
- Cover: RAL 7001
- Handle: RAL 7016

Basis of test:

- IEC/DIN EN 60 947-3
- DIN EN 60 269-2 (fuse inserts)

Note:

- When using components on busbars with contact hazard protection cover, the contact terminal must be used

Size 00 – 3, with electronic fuse monitoring

Size	Packs of	00	1	2	3	Page
Design		3-pole, switchable	3-pole, switchable	3-pole, switchable	3-pole, switchable	
Rated operating current max. A		160	250	400	630	
Rated operating voltage V, ~		400, 3~	400, 3~	400, 3~	400, 3~	
Number of poles		3-pole	3-pole	3-pole	3-pole	
Cable outlet		Top/bottom	Top/bottom	Top/bottom	Top/bottom	
Type of connection		Screw M8	Bolt M12	Bolt M12	Bolt M12	
Connection of round conductors mm ²		1.5 - 95	6 - 240	6 - 240	6 - 240	
Width mm		50	100	100	100	
Height mm		830	830	830	830	
For converter installation		■	■	■	■	
For bar systems with centre-to-centre spacing mm		185	185	185	185	
For bar thickness mm		10	10	10	10	
Model No.	1 pc(s).	9677.015	9677.115	9677.215	9677.315	
Accessories						
Connection space cover	1 pc(s).	see page	9677.410	9677.410	9677.410	383
Contact terminal	3 pc(s).	9677.450	9677.460	9677.460	9677.460	383
Busbar terminal	3 pc(s).	9677.470	9677.480	9677.480	9677.480	384
Prism terminal	3 pc(s).	9677.420	-	-	-	384
V connection terminal	3 pc(s).	-	9677.430	9677.430	9677.440	384
Current converter	1 pc(s).	9677.810	see page	see page	see page	385
Cover	5 pc(s).	-	9677.415	9677.415	9677.415	385
Trim strip	2 pc(s).	9677.407	9677.407	9677.407	9677.407	386
Micro-switch	5 pc(s).	3071.000	3071.000	3071.000	3071.000	358

NH slimline switch-disconnectors



Busbar system Page 368 **Connection adaptors** Page 370 **Connection block** Page 371 **Component adaptors** Page 372

Functions:

- Automatic quick-break contact allows operator-independent switching
- Double-break for reliable disconnection of the contacts

Material:

- Polyamide
- Fire protection corresponding to UL 94-V0
- Contact tracks: Partially silver-plated hard copper

Colour:

- Chassis: RAL 7035
- Cover: RAL 7001
- Handle: RAL 7016

Basis of test:

- IEC/DIN EN 60 947-3
- DIN EN 60 269-2 (fuse inserts)

Size 00, design 3-pole, switchable

Size	Packs of	00	00	00	00	Page
Rated operating current max. A		160	160	160	160	
Rated operating voltage V, ~		690, 3~	690, 3~	690, 3~	690, 3~	
Number of poles		3-pole	3-pole	3-pole	3-pole	
Installation type		Clamping attachment	Clamping attachment	Screw attachment	Screw attachment	
Cable outlet		Bottom	Top	Bottom	Top	
Type of connection		Screw M8	Screw M8	Screw M8	Screw M8	
Connection of round conductors mm ²		1.5 - 95	1.5 - 95	1.5 - 95	1.5 - 95	
Width mm		50	50	50	50	
Height mm		676	676	676	676	
For converter installation		■	■	■	■	
For bar systems with centre-to-centre spacing mm		185	185	185	185	
For bar thickness mm		10	10	10	10	
Model No.	1 pc(s).	9677.060	9677.070	9677.065	9677.075	
Accessories						
Connection space cover	1 pc(s).	9677.400	9677.400	9677.400	9677.400	383
Connection space cover, rear	1 pc(s).	9677.402	9677.402	9677.402	9677.402	386
Clamp-type terminal	3 pc(s).	9677.425	9677.425	9677.425	9677.425	386
Box terminal		-	-	-	-	
Contact terminal		-	-	-	-	
Current converter	1 pc(s).	9677.810	9677.810	9677.810	9677.810	385
Trim strip	2 pc(s).	9677.407	9677.407	9677.407	9677.407	386
Micro-switch	1 pc(s).	9677.418	9677.418	9677.418	9677.418	387

NH slimline switch-disconnectors

Size 1 – 2, design 3-pole, switchable

Size	Packs of	1	1	2	Page
Rated operating current max. A		250	250	400	
Rated operating voltage V, ~		690, 3~	690, 3~	690, 3~	
Number of poles		3-pole	3-pole	3-pole	
Installation type		Screw attachment	Screw attachment	Screw attachment	
Cable outlet		Bottom	Top	Bottom	
Type of connection		Screw M12	Screw M12	Screw M12	
Connection of round conductors mm ²		6 - 240	6 - 240	6 - 240	
Width mm		100	100	100	
Height mm		772	772	772	
For converter installation		–	–	–	
For bar systems with centre-to-centre spacing mm		185	185	185	
For bar thickness mm		10	10	10	
Model No.	1 pc(s).	9677.160	9677.165	9677.260	

Accessories

Connection space cover	1 pc(s).	9677.410	9677.410	9677.410	383
Connection space cover, rear	1 pc(s).	9677.412	9677.412	9677.412	386
Clamp-type terminal		–	–	–	
Box terminal		see page	see page	see page	387
Contact terminal	3 pc(s).	9677.485	9677.485	9677.485	387
Current converter		–	–	–	
Trim strip	2 pc(s).	9677.407	9677.407	9677.407	386
Micro-switch	1 pc(s).	9677.418	9677.418	9677.418	387

Size 2 – 3, design 3-pole, switchable

Size	Packs of	2	3	3	Page
Rated operating current max. A		400	630	500	
Rated operating voltage V, ~		690, 3~	690, 3~	690, 3~	
Number of poles		3-pole	3-pole	3-pole	
Installation type		Screw attachment	Screw attachment	Screw attachment	
Cable outlet		Top	Bottom	Top	
Type of connection		Screw M12	Screw M12	Screw M12	
Connection of round conductors mm ²		6 - 240	6 - 240	6 - 240	
Width mm		100	100	100	
Height mm		772	772	772	
For converter installation		–	–	–	
For bar systems with centre-to-centre spacing mm		185	185	185	
For bar thickness mm		10	10	10	
Model No.	1 pc(s).	9677.265	9677.360	9677.365	

Accessories

Connection space cover	1 pc(s).	9677.410	9677.410	9677.410	383
Connection space cover, rear	1 pc(s).	9677.412	9677.412	9677.412	386
Clamp-type terminal		–	–	–	
Box terminal		see page	see page	see page	387
Contact terminal	3 pc(s).	9677.485	9677.485	9677.485	387
Current converter		–	–	–	
Trim strip	2 pc(s).	9677.407	9677.407	9677.407	386
Micro-switch	1 pc(s).	9677.418	9677.418	9677.418	387

NH slimline switch-disconnectors



Busbar system Page 368 **Connection adaptors** Page 370 **Connection block** Page 371 **Component adaptors** Page 372

Functions:

- Automatic quick-break contact allows operator-independent switching
- Double-break for reliable disconnection of the contacts

Material:

- Polyamide
- Fire protection corresponding to UL 94-V0
- Contact tracks: Partially silver-plated hard copper

Colour:

- Chassis: RAL 7035
- Cover: RAL 7001
- Handle: RAL 7016

Basis of test:

- IEC/DIN EN 60 947-3
- DIN EN 60 269-2 (fuse inserts)

Size 00 – 3, with electronic fuse monitoring

Size	Packs of	00	00	1	2	3	Page
Design		3-pole, switchable	3-pole, switchable	3-pole, switchable	3-pole, switchable	3-pole, switchable	
Rated operating current max. A		160	160	250	400	630	
Rated operating voltage V, ~		400, 3~	400, 3~	400, 3~	400, 3~	400, 3~	
Number of poles		3-pole	3-pole	3-pole	3-pole	3-pole	
Installation type		Clamping attachment	Screw attachment	Screw attachment	Screw attachment	Screw attachment	
Cable outlet		Bottom	Bottom	Bottom	Bottom	Bottom	
Type of connection		Screw M8	Screw M8	Screw M12	Screw M12	Screw M12	
Connection of round conductors mm ²		1.5 - 95	1.5 - 95	6 - 240	6 - 240	6 - 240	
Width mm		50	50	100	100	100	
Height mm		860	860	941	941	941	
For converter installation		■	■	-	-	-	
For bar systems with centre-to-centre spacing mm		185	185	185	185	185	
For bar thickness mm		10	10	10	10	10	
Model No.	1 pc(s).	9677.080	9677.085	9677.180	9677.280	9677.380	
Accessories							
Connection space cover	1 pc(s).	9677.400	9677.400	9677.410	9677.410	9677.410	383
Connection space cover, rear	1 pc(s).	9677.402	9677.402	9677.412	9677.412	9677.412	386
Clamp-type terminal	3 pc(s).	9677.425	9677.425	-	-	-	386
Box terminal		-	-	see page	see page	see page	387
Contact terminal	3 pc(s).	-	-	9677.485	9677.485	9677.485	387
Current converter	1 pc(s).	9677.810	9677.810	-	-	-	385
Trim strip	2 pc(s).	9677.407	9677.407	9677.407	9677.407	9677.407	386
Micro-switch	1 pc(s).	9677.418	9677.418	9677.418	9677.418	9677.418	387

Busbar system 185 mm

Accessories



System attachment

for VX

For attaching busbar systems with 185 mm centre-to-centre spacing inside the enclosure.

Material:

- Sheet steel

Surface finish:

- Zinc-plated

Supply includes:

- 2 system attachments (left/right)
- 2 punched sections without mounting flanges
- Assembly parts

For enclosure width mm	Product-specific scope of supply	Packs of	Model No.
600	–	1 pc(s).	9677.511
800	–	1 pc(s).	9677.521
1000	System attachment (centre)	1 pc(s).	9677.531
1200	System attachment (centre)	1 pc(s).	9677.541



Assembly instruction:

- For variable depth adjustment of the busbar system in the enclosure, the punched section with mounting flange 23 x 64 mm for VX (for the inner mounting level) is additionally required. Select according to the enclosure depth.



Accessories:

- Punched section with mounting flange, 23 x 64 mm, see page 991
- Captive nuts, see page 1002



Busbar connector

For connecting rectangular busbars, no drilling required.

Material:

- E-Cu

Surface finish:

- Tin-plated

Note:

- If using a 100 x 10 mm busbar, one 9677.610 and one 9677.620 are required

For busbar mm	Quantity required per bar	Length mm	Packs of	Model No.
40 x 10	1	40	1 pc(s).	9677.610
80 x 10	2			
100 x 10	1			
60 x 10	1	60	1 pc(s).	9677.620
100 x 10	1			
120 x 10	2			



End cover

for busbar supports

For contact hazard protection of the busbar system on the left and right. Attachment is on the busbar supports.

Material:

- Polyamide
- Fire protection corresponding to UL 94-V0

Colour:

- RAL 7035

Supply includes:

- 1 end cover, left
- 1 end cover, right

To fit Model No.	Packs of	Model No.
9677.500	2 pc(s).	9677.600

Busbar system 185 mm

Accessories

Contact hazard protection cover plate

for 185 mm busbar system

For contact hazard protection of the busbar assembly at the rear and front.

Material:

- Base tray: Polyphenylene ether (PPE)
- End section: Polyphenylene ether (PPE)
- Cover section: Polyamide
- Centre cover: Polyamide

Colour:

- RAL 7035

Supply includes:

- Cover section, slotted, 50 mm wide
- Cover sections, slotted, 100 mm wide
- Base trays
- Trim sections

For enclosure width mm	Product-specific scope of supply	Packs of	Model No.
600	-	1 pc(s).	9677.550
800	-	1 pc(s).	9677.560
1000	Centre cover for busbar support	1 pc(s).	9677.570
1200	Centre cover for busbar support	1 pc(s).	9677.580



Accessories:

- Cover strip, see page 381

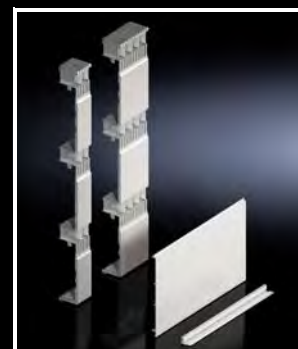

Cover strip

for contact hazard protection cover

For covering the front exposed contact slots in the cover section.

Material:

- Polyamide
- Fire protection corresponding to UL 94-V0

Colour:

- RAL 7035

Width mm	Height mm	To fit Model No.	Packs of	Model No.
100	67	9677.550/ 9677.560/ 9677.570/ 9677.580	3 pc(s).	9677.650



Contact hazard protection cover plate

for enclosure connection

For rear and front contact hazard protection of the connection points from enclosure to enclosure, with and without busbar connectors.

Material:

- Base tray: Polyphenylene ether (PPE)
- Cover section: Polyamide
- Centre cover: Polyamide

Colour:

- RAL 7035

Supply includes:

- 3 base trays
- 1 cover (front)
- 2 centre covers for busbar support

Packs of	Model No.
1 pc(s).	9677.640



Busbar system 185 mm

Accessories



Contact hazard protection cover plate

for connection block

To cover the connector block at the front.

Material:

- Polyamide
- Fire protection corresponding to UL 94-V0

Colour:

- RAL 7035

Width mm	Height mm	Packs of	Model No.
105	245	1 pc(s).	9677.925



Connector kit

for component adaptors

Preassembled connector kit for common brands of moulded-case circuit-breaker (MCCB). For electrical connection between the switch and the component adaptor (3-pole).

Material:

- E-Cu

Supply includes:

- Assembly parts

For switchgear make (model)	To fit Model No.	Packs of	Model No.
ABB (Tmax T7 - 800 A/1000 A) Schneider Electric (NS - 800 A/1000 A)	9677.700/9677.705	1 pc(s).	9677.730
Eaton (NZM4 - 800 A/1000 A) Siemens (VL1250/3VL7 - 1000 A)	9677.700/9677.705	1 pc(s).	9677.740
ABB (Tmax T7 - 1250 A/1600 A) Schneider Electric (NS - 1250 A/1600 A)	9677.710/9677.715	1 pc(s).	9677.750
Eaton (NZM4 - 1250 A/1600 A) Siemens (VL1250/3VL7 - 1250 A, VL1600/VL8 - 1600 A)	9677.710/9677.715	1 pc(s).	9677.760



Contact hazard protection cover plate

for component adaptors

To cover the connector kit at the front. The cover may also optionally be used for the switchgear cable connection. Open cable accesses in the contact hazard protection cover may be sealed using the side panels.

Material:

- Polyamide
- Fire protection corresponding to UL 94-V0

Supply includes:

- Side panels

For switchgear make (model)	Packs of	Model No.
-	1 pc(s).	9677.790
ABB (Tmax T7)	1 pc(s).	9677.792
Eaton (NZM 4)	1 pc(s).	9677.794
Siemens (3VL7/3VL8)	1 pc(s).	9677.796
Schneider Electric (NS1600)	1 pc(s).	9677.798

Connection space cover

for NH slimline fuse-switch-disconnectors/NH slimline switch-disconnectors

Cascadable connection space cover to guarantee contact hazard protection in the cable connection zone when using ring terminals with a long collar.

Material:

- Polycarbonate
- Fire protection corresponding to UL 94-V0

Note:

- When using NH slimline fuse-switch disconnectors with top cable outlet, use of the connection space cover is mandatory

For size	To fit Model No.	Cable outlet	Note on Model No.	Packs of	Model No.
00	9677.0X0/9677.0X5	Bottom	Also suitable for use with NH slimline switch-disconnectors with top cable outlet	1 pc(s).	9677.400
00	9677.000/9677.010/ 9677.015/9677.025	Top	–	1 pc(s).	9677.405
1 - 3	9677.1X0/9677.1X5/ 9677.2X0/9677.2X5/ 9677.300/9677.310/ 9677.3X5	Top/bottom	–	1 pc(s).	9677.410

Contact terminal

for NH slimline fuse-switch disconnectors/ connection adaptors

For mounting components on busbar systems with 185 mm centre-to-centre spacing, no drilling required.

Material:

- Sheet steel, zinc-plated
- E-Cu, tin-plated

Note:

- Only suitable for use on busbar system with contact hazard protection cover (cover section, slotted)

For size	Packs of	Model No.
00	3 pc(s).	9677.450
1 - 3 and connection adaptors	3 pc(s).	9677.460



Busbar system 185 mm

Accessories



Busbar terminal

for NH slimline fuse-switch disconnectors/ connection adaptors

For mounting components on busbar systems with 185 mm centre-to-centre spacing, no drilling required.

Material:

- Sheet steel

Surface finish:

- Zinc-plated

Note:

- Can only be used on busbar systems without contact hazard protection cover (cover section, slotted)

For size	Packs of	Model No.
00	3 pc(s).	9677.470
1 - 3 and connection adaptors	3 pc(s).	9677.480



Prism terminal

for NH slimline fuse-switch disconnectors

For the direct connection of round conductors.

Material:

- Brass

Surface finish:

- Tin-plated

For size	To fit Model No.	Connection of round conductors mm ²	Packs of	Model No.
00	9677.000/ 9677.010/ 9677.015	10 - 95	3 pc(s).	9677.420



V connection terminal

for NH slimline fuse-switch disconnectors

For the direct connection of round conductors.

Material:

- Brass

Surface finish:

- Tin-plated

For size	To fit Model No.	Connection of round conductors mm ²	Packs of	Model No.
1/2	9677.100/ 9677.110/ 9677.115/ 9677.200/ 9677.210/ 9677.215	70 - 240	3 pc(s).	9677.430
3	9677.300/ 9677.310/ 9677.315	120 - 300	3 pc(s).	9677.440

Current converter

for NH slimline fuse-switch-disconnectors/ NH slimline switch-disconnectors

Compact design without altering the installation depth via mechanical integration into the NH slimline switch-disconnector (185 mm centre-to-centre spacing); this allows space-saving assembly.

Material:

– Polyamide

Basis of test:

- IEC 60 044-1
- EN 60715
- DIN VDE 0414
- DIN 42 600-2

For size	00	1 - 3	1 - 3	1 - 3	1 - 3
To fit Model No.	9677.000/ 9677.010/ 9677.015/ 9677.025/ 9677.060/ 9677.065/ 9677.070/ 9677.075/ 9677.080/ 9677.085	9677.100/ 9677.110/ 9677.115/ 9677.200/ 9677.210/ 9677.215/ 9677.300/ 9677.310/ 9677.315/ 9677.340	9677.100/ 9677.110/ 9677.115/ 9677.200/ 9677.210/ 9677.215/ 9677.300/ 9677.310/ 9677.315/ 9677.340	9677.100/ 9677.110/ 9677.115/ 9677.200/ 9677.210/ 9677.215/ 9677.300/ 9677.310/ 9677.315/ 9677.340	9677.100/ 9677.110/ 9677.115/ 9677.200/ 9677.210/ 9677.215/ 9677.300/ 9677.310/ 9677.315/ 9677.340
Primary current A	150	200	250	400	600
Secondary current A	5	5	5	5	5
Accuracy class	1	1	1	1	1
Rated frequency Hz	50 - 60	50 - 60	50 - 60	50 - 60	50 - 60
Insulation voltage kV	3	3	3	3	3
Insulating material category	E	B	B	B	B
Connection of round conductors mm ²	2.5 - 4	–	–	–	–
Type of connection	Screw terminals	Round conductor 2.5 mm ² (length 1.5 m)	Round conductor 2.5 mm ² (length 1.5 m)	Round conductor 2.5 mm ² (length 1.5 m)	Round conductor 2.5 mm ² (length 1.5 m)
Rated power input VA	2.5	1.5	2.5	2.5	2.5
Packs of	1 pc(s).	1 pc(s).	1 pc(s).	1 pc(s).	1 pc(s).
Model No.	9677.810	9677.840	9677.860	9677.870	9677.880

Cover

for NH slimline fuse-switch disconnectors

To increase rear contact hazard protection of the NH slimline fuse-switch-disconnector in the top section when mounting on a 185 mm bar system with contact hazard protection.

Material:

– Polyamide

Colour:

– RAL 7035

For size	Packs of	Model No.
1 - 3	5 pc(s).	9677.415

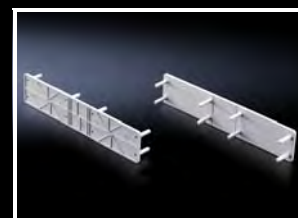

Busbar system 185 mm

Accessories



Trim strip

**for NH slimline fuse-switch-disconnectors/
NH slimline switch-disconnectors**

To create a contact surface for individual use of a front contact hazard protection cover plate. Mounted on the side of the NH strip enclosure.

Material:

– Hard PVC

Colour:

– RAL 7035

For size	Packs of	Model No.
00 - 3	2 pc(s).	9677.407



Connection space cover, rear

for NH slimline switch-disconnectors

To guarantee contact hazard protection in the rear cable connection zone when using ring terminals with long press sleeves. In conjunction with the front connection space cover (9677.400/.410), this achieves all-round contact hazard protection of the connection space.

Material:

– Polyamide

Colour:

– RAL 7035

For size	Packs of	Model No.
00	1 pc(s).	9677.402
1 - 3	1 pc(s).	9677.412



Clamp-type terminal

for NH slimline switch-disconnectors

For the connection of round conductors.

Material:

– Sheet steel

Surface finish:

– Zinc-plated

For size	Connection of round conductors mm ²	Packs of	Model No.
00	16 - 70	3 pc(s).	9677.425

Box terminal

for NH slimline switch-disconnectors

For converting NH slimline switch-disconnectors to box terminal connection for round conductors.

Material:

- Aluminium
- E-Cu, silver-plated

Supply includes:

- Connection space cover, rear

For size	Connection of round conductors mm ²	Packs of	Model No.
1 - 3	70 - 240	3 pc(s).	9677.435
1 - 3	185 - 300	3 pc(s).	9677.445



Contact terminal

for NH slimline switch-disconnectors

For mounting NH slimline switch-disconnectors on bar systems with 185 mm centre-to-centre spacing, no drilling required.

Material:

- Sheet steel, zinc-plated
- E-Cu, tin-plated
- Polyamide

Note:

- Only suitable for use on busbar system with contact hazard protection cover (cover section, slotted)

For size	Packs of	Model No.
1 - 3	3 pc(s).	9677.485



Micro-switch

for NH slimline switch-disconnectors

To indicate the switch position of the NH unit (cover).

Supply includes:

- Bracket

For size	Rated operating current max. A	Rated operating voltage V	Packs of	Model No.
00 - 3	5	250	1 pc(s).	9677.418



Busbar systems (100/185/150 mm)



NH slimline fuse-switch disconnectors Page 335/374

Material: Busbar supports, inserts

- Fibreglass-reinforced, thermo-plastic polyester (PBT)
- Fire protection corresponding to UL 94-V0

Colour:

- RAL 7035

Note:

- The base component of busbar support 3052.000 may also be used as a single-pole support

Busbar systems 1250 A (100 mm), 1600 A (185 mm), 2500 A (150 mm), 3000 A (150 mm)

Busbar supports, 3-pole		Packs of	Model No.				Page	
			A 1250 A	B 1600 A	C 2500 A	C 3000 A		
	Width x height x depth mm		22 x 320 x 70	24 x 515 x 51	30 x 420 x 160	30 x 420 x 170		
	Max. bar accommodation mm		60 x 10	80 x 10	2 x 80 x 10	2 x 100 x 10		
	Inserts for							
	a) Reducing the cross-section to mm		30 x 10 to 50 x 10	50/60 x 10	-	-		
	b) Reducing the bar width in 10 mm increments		-	-	■	■		
	Bar centre distance mm		100	185	150	150		
	Packs of		4 pc(s).	2 pc(s).	2 pc(s).	2 pc(s).		
			3073.000	3052.000	3055.000	3057.000		
	Accessories							
	Inserts to adapt the bar dimensions	30 x 10 mm	24 pc(s).	3074.000	-	-	-	
40 x 10 mm		24 pc(s).	3075.000	-	-	-		
50 x 10 mm		24 pc(s).	3076.000	3074.000	-	-		
60 x 10 mm		24 pc(s).	-	3075.000	-	-		
Spacing piece for reducing the bar width in 10 mm increments	12 pc(s).	-	-	3056.000	3056.000			
Busbars E-Cu to DIN EN 13 601, length 2400 mm								
	Dimensions mm							
	30 x 10	3 pc(s).	3586.005	-	-	-		
	40 x 10	3 pc(s).	3587.000	-	-	-		
	50 x 10	2 pc(s).	3588.005	3588.005	-	-		
	60 x 10	2 pc(s).	3589.005	3589.005	3589.005	3589.005		
	80 x 10	1 pc(s).	-	3590.005	3590.005	3590.005		
100 x 10	1 pc(s).	-	-	-	3590.015			
						342		

Busbar systems (100/185/150 mm)

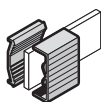
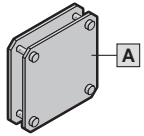
Contact hazard protection		Packs of	Model No.				Page
			1250 A	1600 A	2500 A	3000 A	
End cover for busbar supports		10 pc(s).	3083.000	-	-	-	343
	Busbar cover section, length 1 m for E-Cu	30 x 10 mm	10 pc(s).	3092.000	-	-	
		40 x 10 to 60 x 10 mm	10 pc(s).	3085.000	3085.000	-	
Connection system, see page 349 (system accessories)							
A Plate clamps for connecting laminated copper bars; no drilling required							
	For busbars mm	Clamping area for laminated copper bars mm					350
	30 x 10	34 x 10	3 pc(s).	3554.000	-	-	
	40 x 10	34 x 10	3 pc(s).	3559.000	-	-	
	50 x 10	34 x 10	3 pc(s).	3560.000	3560.000	-	
	50 x 10	54 x 10	3 pc(s).	3562.000	3562.000	-	
	60 x 10	34 x 10	3 pc(s).	3561.000	3561.000	-	
	60 x 10	54 x 10	3 pc(s).	3563.000	3563.000	-	
	80 x 10	65 x 10	3 pc(s).	-	3460.500	-	
B Push-in conductor connection clamps for 10 mm bar thickness							
Connection of round conductors mm ²		Clamping area for laminated copper bars mm					349
0.5 – 6		-	10 pc(s).	3455.505	3455.505	3455.505	
1.5 – 16		-	10 pc(s).	3456.505	3456.505	3456.505	
Conductor connection clamps for 10 mm bar thickness							
Connection of round conductors mm ²		Clamping area for laminated copper bars mm					349
C 1 – 4		-	15 pc(s).	3555.000	3555.000	3555.000	
1 – 4		-	15 pc(s).	3455.500	3455.500	3455.500	
2.5 – 16		8 x 8	15 pc(s).	3456.500	3456.500	-	
D 16 – 50		10.5 x 11	15 pc(s).	3457.500	3457.500	-	
35 – 70		16.5 x 15	15 pc(s).	3458.500	3458.500	-	
70 – 185		22.5 x 20	15 pc(s).	3459.500	3459.500	-	
E System covers for conductor connection clamps and plate clamps							
Width x depth mm							350
50 x 80			4 pc(s).	3086.000	-	-	
100 x 80			4 pc(s).	3087.000	-	-	
100 x 110			4 pc(s).	3090.000	-	-	
200 x 80			4 pc(s).	3088.000	-	-	
200 x 110			4 pc(s).	3091.000	-	-	
F Inserted screw nuts M12 , self-holding nuts with knurled ring for mounting NH slimline fuse-switch disconnectors							
For drilled holes in busbars Ø 14.5 mm			30 pc(s).	3591.060	3591.060	-	1039
G Connection plate for laminated copper bars							
For connecting laminated copper bars up to 2 x 10 x 100 x 1.0 mm to a busbar system with 2 bars per conductor		For laminated copper bars up to					399
		2 x 10 x 32 x 1 mm	1 pc(s).	-	-	9676.747 ¹⁾	
		2 x 10 x 63 x 1 mm	1 pc(s).	-	-	9676.748 ¹⁾	
		2 x 10 x 100 x 1 mm	1 pc(s).	-	-	9676.749 ¹⁾	
H Direct connection terminal							
For the direct connection of round conductors 95 – 300 mm ² (single-wire and multi-wire)			1 pc(s).	-	-	9676.730 ¹⁾	9676.730 ¹⁾

¹⁾ The required screw connection must be ordered separately according to the busbar width, see page 400

VX25 Ri4Power – Greater flexibility with interior installation



Variable adaptation

- Removal of the pre-punched knock-outs in the compartment dividers is burr-free, for flexible subdivision of the openings depending on the planned cable routing. This supports a continuous, direct power supply to the control and wiring sections.
- Cross member cutter 4054.870 for removing the pre-punched knock-outs, see page 586.

Flexible busbar routing

- The main busbars may optionally be routed in the roof section or central rear section, for enhanced planning and space flexibility.

Optimum continuity

- Because PE or N conductors are connected by directly screw-fastening the busbar supports to the frame section, this ensures an identical, consistent arrangement of bars in the rear or front enclosure area across all section types.



VX25 Ri4Power – Enhanced efficiency for bar systems



Significant reduction in parts

- The 25 mm pitch pattern allows busbar supports to be mounted directly onto the enclosure section. Just three screws is all you need. No further components are required.

A high level of standardisation

- Standard bars in sizes 30 x 10 mm and 50 x 10 mm are used.

Quick busbar connection

- The open busbar support can additionally accommodate the busbar connector, for simple, fast connection to the next section.



Power distribution



Busbar system

Flat-PLS



Busbar supports

for distribution busbar system

For assembling vertical distribution busbar systems (2 x 30 x 10 mm, 3-/4-pole, 70 mm centre-to-centre spacing) or busbar systems (30 x 5/10 mm, 3-/4-pole, 60 mm centre-to-centre spacing) with RiLine components in modular outgoing sections.

Material:

- Duroplastic
- Fire protection corresponding to UL 94-V0

Colour:

- Similar to RAL 9005

Supply includes:

- Assembly parts

For busbar mm	Bar centre distance mm	Packs of	Model No.
30 x 5/10	60	2 pc(s).	9686.100
30 x 10	70		



Also required:

- Busbars E-Cu, see page 342



Accessories:

- End cover, see page 396



Busbar supports

for busbar entry (roof section)

For inserting 3- or 4-pole flat copper busbar systems into the roof section.

Material:

- Duroplastic
- Fire protection corresponding to UL 94-V0

Colour:

- Similar to RAL 9005

Supply includes:

- Assembly parts

For busbar mm	Bar centre distance mm	Packs of	Model No.
30 x 10	80	2 pc(s).	9686.010
50 x 10	80	2 pc(s).	9686.040



Also required:

- Busbars E-Cu, see page 342
- Captive nuts, see page 1002



Assembly instruction:

- For the installation of max. 4 busbars (sub-conductors) per phase
- Cage nut (M8) 4165.500 is required to attach the busbar supports to the enclosure section.



Accessories:

- End cover, see page 396



Busbar system

Flat-PLS

Busbar supports

for busbar baying (roof section)

For baying 3- or 4-pole flat copper busbar systems from enclosure to enclosure in the roof section.

Material:

- Duroplastic
- Fire protection corresponding to UL 94-V0

Colour:

- Similar to RAL 9005

Supply includes:

- Assembly parts

For busbar mm	Bar centre distance mm	Packs of	Model No.
30 x 10	80	2 pc(s).	9686.000
50 x 10	80	2 pc(s).	9686.030



Also required:

- Busbars E-Cu, see page 342
- Longitudinal connector E-Cu, see page 397
- Captive nuts, see page 1002



Assembly instruction:

- For the installation of max. 4 busbars (sub-conductors) per phase
- Cage nut (M8) 4165.500 is required to attach the busbar supports to the enclosure section.



Accessories:

- End cover, see page 396



Possible alternative:

- Busbar E-Cu, slotted, see page 396



Power distribution

Busbar supports

for busbar entry (rear section)

For inserting 3-pole flat copper busbar systems into the rear section of the enclosure.

Material:

- Duroplastic
- Fire protection corresponding to UL 94-V0

Colour:

- Similar to RAL 9005

Supply includes:

- Assembly parts

For busbar mm	Bar centre distance mm	Packs of	Model No.
50 x 10	185	2 pc(s).	9686.070



Also required:

- Busbars E-Cu, see page 342
- Captive nuts, see page 1002



Assembly instruction:

- For the installation of max. 4 busbars (sub-conductors) per phase
- Cage nut (M8) 4165.500 is required to attach the busbar supports to the enclosure section.



Accessories:

- End cover, see page 396



Busbar system

Flat-PLS



Busbar supports

for busbar baying (rear section)

For baying 3-pole flat copper busbar systems in the rear section from enclosure to enclosure.

Material:

- Duroplastic
- Fire protection corresponding to UL 94-V0

Colour:

- Similar to RAL 9005

Supply includes:

- Assembly parts

For busbar mm	Bar centre distance mm	Packs of	Model No.
50 x 10	185	2 pc(s).	9686.060



Also required:

- Busbars E-Cu, see page 342
- Longitudinal connector E-Cu, see page 397
- Captive nuts, see page 1002



Assembly instruction:

- For the installation of max. 4 busbars (sub-conductors) per phase
- Cage nut (M8) 4165.500 is required to attach the busbar supports to the enclosure section.



Accessories:

- End cover, see page 396



Possible alternative:

- Busbar E-Cu, slotted, see page 396



End cover

for busbar supports

For shock-hazard-protected covering of the busbar ends on the busbar holder.

Material:

- Polyamide
- Fire protection corresponding to UL 94-HB

Colour:

- Similar to RAL 9005

Supply includes:

- Assembly parts

Width mm	Height mm	Packs of	Model No.
50	147	3 pc(s).	9686.080



Busbar E-Cu, slotted

Busbars with integral punchings.

Material:

- E-Cu F30

Standards:

- DIN EN 13 601

Dimensions mm	Length mm	Hole diameter mm	Packs of	Model No.
50 x 10	385	11.5	1 pc(s).	9684.004
50 x 10	585	11.5	1 pc(s).	9684.006
50 x 10	785	11.5	1 pc(s).	9684.008
50 x 10	985	11.5	1 pc(s).	9684.010
50 x 10	1185	11.5	1 pc(s).	9684.012



Accessories:

- Longitudinal connector E-Cu, see page 397

Longitudinal connector E-Cu

for busbar baying

For connecting the main busbar system from enclosure to enclosure.

Material:

- E-Cu

Supply includes:

- Assembly parts



Design for main busbar 30 x 10 mm

Dimensions mm	Length mm	No. of sub-conductors per phase	Packs of	Model No.
35 x 10	195	1	1 pc(s).	9686.210
60 x 10	195	2 4	1 pc(s).	9686.200

Design for main busbar 50 x 10 mm

Dimensions mm	Length mm	No. of sub-conductors per phase	Packs of	Model No.
55 x 10	195	1	1 pc(s).	9686.260
100 x 10	195	2 4	1 pc(s).	9686.250

Busbar system

Connection system Flat-PLS

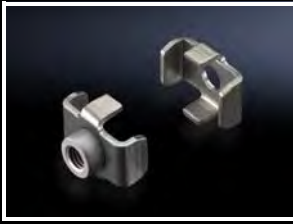

Busbar claw

for flat copper busbars

For mechanical stabilisation of busbar stacks. Suitable for 10 mm bar thickness.

Material:

- Stainless steel

For no. of busbars	Mounting dimensions mm	Packs of	Model No.
2	20	1 pc(s).	9676.017
4	20	1 pc(s).	9676.019



Also required:

- M10 screw, see page 400



Assembly instruction:

- The required screw length must be selected in line with the busbar width W, i.e. length = W + fastening measurement. Screws are not included with the supply.
- Busbar claw with threaded insert M10

Busbar claw

for connection components

For mechanical connection of connection components such as connection brackets. Suitable for 10 mm bar thickness.

Material:

- Stainless steel

For no. of busbars	Mounting dimensions mm	Packs of	Model No.
2	40	8 pc(s).	9676.832



Also required:

- M10 screw, see page 400



Assembly instruction:

- The required screw length must be selected in line with the busbar width W, i.e. length = W + fastening measurement. Screws are not included with the supply.
- Busbar claw with threaded insert M10

Direct connection terminal

for round conductors

For connecting round conductors to a busbar distributor system made from flat copper. Suitable for 10 mm bar thickness.

Material:

- Connection clamp: Brass, tin-plated
- Busbar claw: Stainless steel

Supply includes:

- Assembly parts (excluding screws)

No. of sub-conductors per phase	Connection of round conductors mm ²	Mounting dimensions mm	Packs of	Model No.
2	95 - 300	60	1 pc(s).	9676.730



Also required:

- M10 screw, see page 400



Assembly instruction:

- The required screw length must be selected in line with the busbar width W, i.e. length = W + fastening measurement. Screws are not included with the supply.
- Busbar claw with threaded insert M10

Busbar system

Connection system Flat-PLS

Connection plate

for laminated copper bars

For connecting laminated copper bars to a busbar distributor system made from flat copper. Suitable for 10 mm bar thickness.

Material:

- Connection plate: E-Cu
- Thrust piece: Stainless steel
- Busbar claw: Stainless steel

Supply includes:

- Assembly parts (excluding screws)

No. of sub-conductors per phase	Clamping area for laminated copper bars (W x H) mm	Mounting dimensions mm	Packs of	Model No.
2	32 x 20	50	1 pc(s).	9676.747
2	63 x 20	50	1 pc(s).	9676.748
2	100 x 20	50	1 pc(s).	9676.749



Also required:

- M10 screw, see page 400



Assembly instruction:

- The required screw length must be selected in line with the busbar width W, i.e. length = W + fastening measurement. Screws are not included with the supply.
- Busbar claw with threaded insert M10



Accessories:

- Laminated copper bar, see page 346



Connection plate

for ring terminals

For connecting ring terminals to a busbar distributor system made from flat copper. Suitable for 10 mm bar thickness.

Material:

- Connection plate: E-Cu, nickel-plated
- Busbar claw: Stainless steel

Supply includes:

- Assembly parts (excluding screws)

Thread	No. of sub-conductors per phase	Mounting dimensions mm	Product-specific scope of supply	Packs of	Model No.
M10	2	40	-	1 pc(s).	9676.710
M12	2	20	Grub screw	1 pc(s).	9676.700



Also required:

- M10 screw, see page 400



Assembly instruction:

- The required screw length must be selected in line with the busbar width W, i.e. length = W + fastening measurement. Screws are not included with the supply.
- Busbar claw with threaded insert M10



Busbar system

Connection system Flat-PLS



Connection set

for Flat-PLS

For attaching NH slimline fuse-switch disconnectors and NH slimline switch-disconnectors (185 mm) or for connecting busbars. Suitable for busbar system with flat copper 50 x 10 mm

Material:

- Sheet steel, zinc-plated

Note:

- Screws are not included with the supply

Thread	For no. of busbars	Packs of	Model No.
M8	2	3 pc(s).	9686.800
	4		
M10	2	3 pc(s).	9686.810
	4		

Assembly instruction:

- The connection set may only be used with top-mounting components with screw fastening
- NH slimline fuse-switch disconnectors:
The required screw length when using busbars is 2 x 50 x 10 mm = 35 mm and 4 x 50 x 10 mm = 55 mm
- NH slimline switch-disconnectors: Only suitable for attaching to busbars 2 x 50 x 10 mm
- When using 4 busbars per phase, a filler piece is additionally required

Accessories:

- M10 screw, see page 400
- Filler piece, see page 400



Filler piece

for connection set

When using top-mounting components on a busbar system with 4 busbars per phase, a filler piece is additionally required between the bars.

Material:

- E-Cu

Dimensions mm	Length mm	Packs of	Model No.
25 x 10	110	3 pc(s).	9686.820



M10 screw

For attaching the busbar claw or connection components to a flat copper busbar system.

Material:

- Stainless steel

Screw design mm	Packs of	Model No.
M10 x 60	8 pc(s).	9676.806
M10 x 70	8 pc(s).	9676.807
M10 x 80	8 pc(s).	9676.808
M10 x 90	8 pc(s).	9676.809
M10 x 100	8 pc(s).	9676.810
M10 x 110	8 pc(s).	9676.811
M10 x 120	8 pc(s).	9676.812
M10 x 130	8 pc(s).	9676.813
M10 x 140	8 pc(s).	9676.814
M10 x 150	8 pc(s).	9676.815
M10 x 160	8 pc(s).	9676.816
M10 x 170	8 pc(s).	9676.817
M10 x 190	8 pc(s).	9676.819

Busbar system

Maxi-PLS

End supports

for Maxi-PLS busbars

For attaching Maxi-PLS busbars when used as a cable connection system. The stepped configuration ensures simple cable installation.

Material:

- Polyamide
- Fire protection corresponding to UL 94-V0

Colour:

- Similar to RAL 9011

Supply includes:

- Assembly parts

For system	Packs of	Model No.
Maxi-PLS 45 S Maxi-PLS 45	2 pc(s).	9649.010
Maxi-PLS 60	2 pc(s).	9659.010



Also required:

- Maxi-PLS busbar, E-Cu for Maxi-PLS 45 S system, see page 401
- Maxi-PLS busbar, E-Cu for Maxi-PLS 45 system, see page 401
- Maxi-PLS busbar, E-Cu for Maxi-PLS 60 system, see page 402



Maxi-PLS busbar, E-Cu

for Maxi-PLS 45 S system

For assembling cable connection systems.

Material:

- E-Cu

Note:

- May be cut individually to required length

Cross-section 974 mm²

For enclosure width mm	Length mm	Packs of	Model No.
600	451	1 pc(s).	9640.207
800	651	1 pc(s).	9640.237
1000	851	1 pc(s).	9640.267
1200	1051	1 pc(s).	9640.297
-	2400	3 pc(s).	9640.365

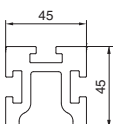

Maxi-PLS 45 S



Maxi-PLS busbar, E-Cu

for Maxi-PLS 45 system

For assembling cable connection systems.

Material:

- E-Cu

Note:

- May be cut individually to required length

Cross-section 1354 mm²

For enclosure width mm	Length mm	Packs of	Model No.
600	451	1 pc(s).	9640.202
800	651	1 pc(s).	9640.232
1000	851	1 pc(s).	9640.262
1200	1051	1 pc(s).	9640.292
-	2400	3 pc(s).	9640.360
-	2400	4 pc(s).	9649.360

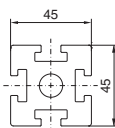

Maxi-PLS 45



Busbar system

Maxi-PLS



Maxi-PLS busbar, E-Cu

for Maxi-PLS 60 system

For assembling cable connection systems.

Material:

– E-Cu

Note:

– May be cut individually to required length

Cross-section 2323 mm²

For enclosure width mm	Length mm	Packs of	Model No.
600	451	1 pc(s).	9650.202
800	651	1 pc(s).	9650.232
1000	851	1 pc(s).	9650.262
1200	1051	1 pc(s).	9650.292
–	2400	3 pc(s).	9650.360
–	2400	4 pc(s).	9659.360

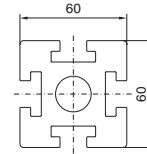

Maxi-PLS 60



Busbar system

Connection system Maxi-PLS

Connection clamp

for round conductors

For the connection of round conductors.

Material:

- Connection clamp: Brass, tin-plated
- Terminal stud: Steel, zinc-plated
- Sliding block: E-Cu

Supply includes:

- Connection clamp
- Terminal studs
- Sliding block
- Assembly parts

For system	Connection of round conductors mm ²	Packs of	Model No.
Maxi-PLS 45 S/45	95 - 300	1 pc(s).	9640.325
Maxi-PLS 60	95 - 300	1 pc(s).	9650.325



Connection plate

for laminated copper bars

For the connection of laminated flat copper bars.

Material:

- Connection plate: E-Cu
- Thrust piece: Stainless steel

Supply includes:

- Assembly parts

For system	Clamping area for laminated copper bars (W x H) mm	Packs of	Model No.
Maxi-PLS 45 S/45	32 x 20	3 pc(s).	9640.330
Maxi-PLS 45 S/45	63 x 20	3 pc(s).	9640.340
Maxi-PLS 45 S/45	100 x 20	3 pc(s).	9640.350
Maxi-PLS 60	32 x 20	3 pc(s).	9650.330
Maxi-PLS 60	63 x 20	3 pc(s).	9650.340



Accessories:

- Laminated copper bar, see page 346

Terminal studs

for Maxi-PLS

For connecting cables with ring terminals.

Material:

- Terminal stud: Steel, zinc-plated
- Sliding block: E-Cu

Supply includes:

- Terminal studs
- Sliding blocks
- Assembly parts

For system	Thread	Thread length mm	Packs of	Model No.
Maxi-PLS 45 S/45	M12	30	3 pc(s).	9640.370
Maxi-PLS 45 S/45	M16	30	3 pc(s).	9640.380
Maxi-PLS 60	M12	32	3 pc(s).	9650.370
Maxi-PLS 60	M16	32	3 pc(s).	9650.380

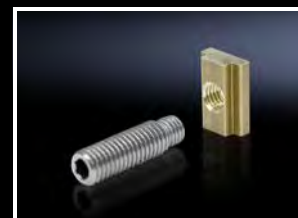

Sliding block

for Maxi-PLS busbars

For attaching flat copper bars and connection components to Maxi-PLS busbars. For sliding into the busbar section at the side and tightening the threaded bolts.

Material:

- E-Cu

For system	Length mm	Thread	Packs of	Model No.
Maxi-PLS 45 S/45	20	M8	15 pc(s).	9640.970
Maxi-PLS 45 S/45	25	M10	15 pc(s).	9640.980
Maxi-PLS 60	25	M10	15 pc(s).	9650.980
Maxi-PLS 60	35	M12	15 pc(s).	9650.990

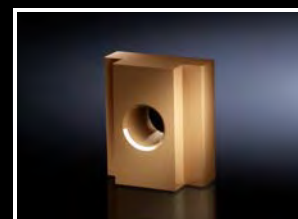

Also required:

- Threaded bolts, see page 404

Busbar system

Connection system Maxi-PLS



Sliding nut

for Maxi-PLS busbars

For attaching flat copper bars and connection components to Maxi-PLS busbars. For sliding into the busbar section retrospectively and tightening the threaded bolts.

Material:

- E-Cu

For system	Thread	Packs of	Model No.
Maxi-PLS 45 S/45	M6	15 pc(s).	9640.900
Maxi-PLS 45 S/45	M8	15 pc(s).	9640.910
Maxi-PLS 45 S/45	M10	15 pc(s).	9640.920
Maxi-PLS 60	M6	15 pc(s).	9650.900
Maxi-PLS 60	M8	3 pc(s).	9650.905
Maxi-PLS 60	M10	15 pc(s).	9650.910
Maxi-PLS 60	M12	15 pc(s).	9650.920



Also required:

- Threaded bolts, see page 404



Threaded bolts

for sliding blocks and sliding nuts

For individual connection options.

Material:

- Steel

Supply includes:

- Assembly parts



Also required:

- Sliding block, see page 403
- Sliding nut, see page 404

For system	Thread	Thread length mm	Packs of	Model No.
Maxi-PLS 45 S/45 Maxi-PLS 60	M6	35	6 pc(s).	9640.930
Maxi-PLS 45 S/45 Maxi-PLS 60	M8	35	6 pc(s).	9640.940
Maxi-PLS 45 S/45 Maxi-PLS 60	M10	35	8 pc(s).	9676.971
Maxi-PLS 45 S/45 Maxi-PLS 60	M10	45	8 pc(s).	9676.972
Maxi-PLS 45 S/45 Maxi-PLS 60	M10	55	8 pc(s).	9676.973
Maxi-PLS 45 S/45 Maxi-PLS 60	M10	70	8 pc(s).	9676.976
Maxi-PLS 45 S/45 Maxi-PLS 60	M10	80	8 pc(s).	9676.977
Maxi-PLS 60	M12	40	8 pc(s).	9676.981
Maxi-PLS 60	M12	50	8 pc(s).	9676.982
Maxi-PLS 60	M12	60	8 pc(s).	9676.983
Maxi-PLS 60	M12	70	8 pc(s).	9676.986
Maxi-PLS 60	M12	80	8 pc(s).	9676.987



Compact infeed

for Maxi-PLS

For individual use as a 3-pole cable connection bar system. Direct mounting on the mounting plate or punched section without mounting flange.

Material:

- End support: Polyamide (PA 6)
- Retaining plate: Sheet steel, zinc-plated
- Punched rail: Sheet steel, zinc-plated

Supply includes:

- 6 end supports
- 2 support plates for end supports
- 1 punched rail 23 x 23 mm (length 495 mm)
- Assembly parts

For system	Packs of	Model No.
Maxi-PLS 45 S/45	1 pc(s).	9660.980

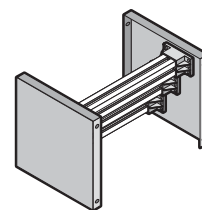

Busbar system

Accessories for connection components

Screw

for connection components

For connecting components such as connection brackets and connection kits.

Material:

- Sheet steel, zinc-plated

Supply includes:

- 8 nuts and 16 washers

Screw design mm	Packs of	Model No.
M10 x 40	8 pc(s).	9676.966
M10 x 45	8 pc(s).	9686.845
M10 x 55	8 pc(s).	9686.865
M10 x 60	8 pc(s).	9676.967
M10 x 80	8 pc(s).	9676.968



Support set (stabiliser)

for connector kit

To support connector kits, top or bottom, for open air circuit-breakers (ACB).

Material:

- Stabiliser: Fibreglass-reinforced polyester
- Angle bracket: Sheet steel

Supply includes:

- 4 plastic stabilisers
- 2 angle brackets
- Assembly parts

Note:

- The angle brackets included with the supply are only suitable for use in TS enclosures
- When using the support set in VX enclosures, angle bracket 9686.495 is additionally required

Packs of	Model No.
1 pc(s).	9660.205

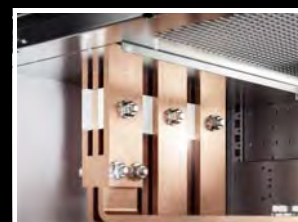

Angle bracket

for support set (stabiliser)

For positioning and securing the holder set (stabiliser) to the enclosure section.

Material:

- Sheet steel, zinc-plated

Supply includes:

- Assembly parts

Note:

- An angle bracket consists of one bracket to be fastened to the enclosure section or the compartment side panel, and one bracket for mounting plastic stabilisers

Packs of	Model No.
4 pc(s).	9686.495



Busbar system

Connection components

Connection components for air circuit-breakers and busbar connections

For connecting air circuit-breakers (ACB) or for connecting horizontal and vertical busbar systems (T-connectors).

Material:

- E-Cu

Note:

- The design code required for the configuration code is generated by the VX25 Rittal Power Engineering software (www.rittal.com/rpevx25/)
- Please quote the complete configuration code on all enquiries and orders (see example)

Configuration code = order number + design code	Description	Section types
Model No. 9686.912 + design code	Connector kit for top/bottom	Air circuit-breakers (ACB), coupling section, cable transition section
Model No. 9686.924 + design code	T-connector kit for top/bottom	Modular outgoing feeder section, fuse-switch disconnect section horizontal/vertical, multi-terminal busbar section, riser section, corner section

Example of creating the configuration code

1. Select section type "air circuit-breaker"



Busbar system

Connection components

2. Select switch and manufacturer and enter other technical parameters, such as busbar position, number of poles, rated current etc.



3. The connector kit data is output using the "Determine prices and weights" function. Design code and associated drawings (.dwg, .pdf) are available via the "Download" function. The configuration code for the enquiry or order will then look like this:
Air circuit-breaker (ACB) Model No. 9686.912 + 8068A1A4H3V661O4-70



Power distribution

Cover systems

Form 1

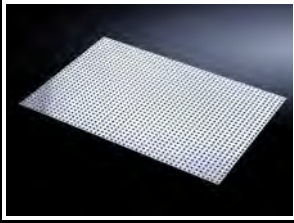

Cover plate

Slotted

To cover live parts and comply with the internal protection category IP 2X and IP XXB within low-voltage switchgear and controlgear. Integral vent holes allow convection inside a system.

Material:

- PVC

Width mm	Height mm	Packs of	Model No.
1200	800	1 pc(s).	9674.990



Accessories:

- Mounting bracket, see page 408



Mounting bracket

for contact hazard protection cover

For the attachment of contact hazard protection covers. Tapped hole M6.

Material:

- Sheet steel

Surface finish:

- Zinc-plated

Supply includes:

- Assembly screws

Packs of	Model No.
24 pc(s).	9660.090

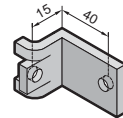

Contact hazard protection cover plate

for enclosures with NH slimline fuse-switch disconnectors

To cover outgoing sections with NH slimline fuse-switch disconnectors and busbar system in the rear enclosure section so that they are safe from finger contact (IP 2X).

Material:

- Sheet steel, 1.5 mm

Surface finish:

- Zinc-plated

Supply includes:

- 4 side panels (left/right side)
- 2 side panels (top/bottom)
- Assembly parts

Note:

- The specified installation width when using the contact hazard protection cover only applies when using busbar supports 9686.060/9686.070

For enclosure width mm	Free installation width when using Flat-PLS mm	Packs of	Model No.
600	400	1 pc(s).	9684.960
800	600	1 pc(s).	9684.980
1000	800	1 pc(s).	9684.900
1200	1000	1 pc(s).	9684.920



Accessories:

- Blanking cover, see page 409



Blanking cover

for contact hazard protection cover

To cover free NH slimline fuse-switch disconnector slots.

Material:

- Sheet steel, 1.5 mm

Surface finish:

- Zinc-plated

Supply includes:

- 2 covers
- 2 cover brackets
- Assembly parts

Width mm	Packs of	Model No.
50	2 pc(s).	9684.990



Compartment configuration

Form 1-4



Compartment side panel

for VX

Side divider panel for attaching partial mounting plates and compartment dividers.

Material:

- Sheet steel, 1.5 mm

Surface finish:

- Zinc-plated

Supply includes:

- Assembly parts



For busbar system assembly in the rear section

For enclosure height mm	For enclosure depth mm	Height mm	Depth mm	Packs of	Model No.
2000	600	1881	538	2 pc(s).	9683.006
2000	800	1881	738	2 pc(s).	9683.008

For busbar system assembly in the roof section

For enclosure height mm	For enclosure depth mm	Height mm	Depth mm	Packs of	Model No.
2000	600	1731	538	2 pc(s).	9683.016
2000	800	1731	738	2 pc(s).	9683.018
2200	600	1931	538	2 pc(s).	9683.036
2200	800	1931	738	2 pc(s).	9683.038



Accessories:

- Plastic gland plate, see page 410
- Compartment divider, see page 411
- Partial mounting plate, see page 413



Plastic gland plate

for compartment side panel

For closing cable entry openings.

Material:

- PVC, 3 mm

Colour:

- Similar to RAL 7045

Supply includes:

- Assembly parts

Width mm	Height mm	Packs of	Model No.
152	48	10 pc(s).	9683.040



Retaining plate

for cable connection space

For mounting Maxi-PLS busbars including end supports in the cable connection area.

Material:

- Sheet steel, 1.5 mm

Surface finish:

- Zinc-plated

Supply includes:

- Assembly parts

For enclosure depth mm	Height mm	Depth mm	Packs of	Model No.
600	375	543	2 pc(s).	9683.200
800	375	743	2 pc(s).	9683.210



Also required:

- End supports, see page 401

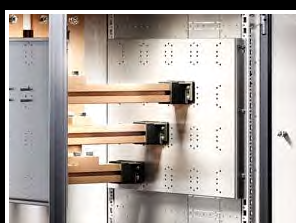

Compartment configuration

Form 1-4

Terminal box

for modular outgoing section

For shielding the connections (terminals) of the compartment, busbar space and cable chamber in accordance with Form 4b to IEC 61 439-2.

Material:

- Lid and cover: Sheet steel, 1.5 mm
- Cable retainer: Sheet steel

Surface finish:

- Lid and cover: Zinc-plated

Supply includes:

- 2 lids (top/bottom)
- 2 covers (front/rear)
- 2 cable retainers
- Assembly parts

For enclosure depth mm	For compartment height mm	Packs of	Model No.
600 800	150	1 pc(s).	9683.701
600 800	200	1 pc(s).	9683.702
600 800	300	1 pc(s).	9683.703
600 800	400	1 pc(s).	9683.704
600 800	600	1 pc(s).	9683.706



Also required:

- Compartment side panel, see page 410



Assembly instruction:

- The terminal boxes are externally mounted on the compartment side panel in the cable chamber, to match the heights of the compartments
- If necessary, a clamping strip may be mounted on the cable retainer included with the supply



Compartment divider

for VX

For the horizontal separation of compartments. In combination with the side panels, this creates Form separation to Form 1 to 4. For attachment to the compartment side panel or the enclosure section. The integral cut-outs with pre-punched knock-out option are used for the vertical routing of control lines or cable ducts and for the routing of distribution busbars or connection kits.

Design:

- With louvres

Material:

- Sheet steel, 1.5 mm

Surface finish:

- Zinc-plated

Supply includes:

- Assembly parts



Assembly instruction:

- For assembling compartments as internal Form separation, compartment side panels are required



Accessories:

- Plastic gland plate, see page 412
- Compartment side panel, see page 410



For enclosure width mm	For enclosure depth mm	Width mm	Depth mm	Packs of	Model No.
400	400	311	380	2 pc(s).	9683.444
400	600	311	580	2 pc(s).	9683.446
400	800	311	780	2 pc(s).	9683.448
600	400	511	380	2 pc(s).	9683.464
600	600	511	580	2 pc(s).	9683.466
600	800	511	780	2 pc(s).	9683.468
800	400	711	380	2 pc(s).	9683.484
800	600	711	580	2 pc(s).	9683.486
800	800	711	780	2 pc(s).	9683.488
1000	600	911	580	2 pc(s).	9683.406
1000	800	911	780	2 pc(s).	9683.408
1200	600	1111	580	2 pc(s).	9683.426
1200	800	1111	780	2 pc(s).	9683.428

Compartment configuration

Form 1-4

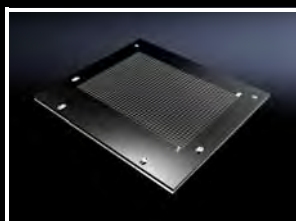

Plastic gland plate

for compartment divider

To cover the compartment divider with gland.

Material:

- ABS

Colour:

- Similar to RAL 9005

Supply includes:

- Assembly parts

Width mm	Height mm	Packs of	Model No.
250	251	2 pc(s).	9683.504
450	251	2 pc(s).	9683.506
650	251	2 pc(s).	9683.508
850	251	2 pc(s).	9683.500



Air circuit-breaker support bar

For the configuration of air circuit-breakers (ACB) in compartments.

Material:

- Sheet steel, 2.5 mm

Surface finish:

- Zinc-plated

Supply includes:

- Assembly parts

For enclosure width mm	Length mm	Packs of	Model No.
400	296	2 pc(s).	9683.304
600	496	2 pc(s).	9683.306
800	696	2 pc(s).	9683.308
1000	896	2 pc(s).	9683.310
1200	1096	2 pc(s).	9683.312

**Also required:**

- Mounting bracket, see page 412



Mounting bracket

for air circuit-breaker support rail

For attaching the air circuit-breaker support rail to the enclosure section or compartment side panel.

Material:

- Sheet steel, 2.5 mm

Surface finish:

- Zinc-plated

Supply includes:

- Assembly parts

For enclosure depth mm	Packs of	Model No.
600	2 pc(s).	9683.326
800	2 pc(s).	9683.328

Compartment configuration

Form 1-4

Partial mounting plate

for compartment side panel

For direct attachment to the compartment side panel for internal compartmentalisation. Universal interior installation with switchgear and controlgear. Creation of additional mounting levels. In combination with compartment dividers and side panel, internal compartmentalisation in accordance with Form 1 to 4 is possible.

Material:

– Sheet steel, 2 mm

Surface finish:

– Zinc-plated

Supply includes:

– Angle brackets and assembly parts

Design Solid

For enclosure width mm	For compartment height mm	Width mm	Height mm	Packs of	Model No.
400	200	302	193	1 pc(s).	9683.642
400	300	302	293	1 pc(s).	9683.643
400	400	302	393	1 pc(s).	9683.644
400	600	302	593	1 pc(s).	9683.646
400	800	302	793	1 pc(s).	9683.648
600	1000	502	993	1 pc(s).	9683.660
600	150	502	143	1 pc(s).	9683.661
600	200	502	193	1 pc(s).	9683.662
600	300	502	293	1 pc(s).	9683.663
600	400	502	393	1 pc(s).	9683.664
600	600	502	593	1 pc(s).	9683.666
600	800	502	793	1 pc(s).	9683.668
800	1000	702	993	1 pc(s).	9683.680
800	150	702	143	1 pc(s).	9683.681
800	200	702	193	1 pc(s).	9683.682
800	300	702	293	1 pc(s).	9683.683
800	400	702	393	1 pc(s).	9683.684
800	600	702	593	1 pc(s).	9683.686
800	800	702	793	1 pc(s).	9683.688
1000	400	902	393	1 pc(s).	9683.604
1000	600	902	593	1 pc(s).	9683.606
1000	800	902	793	1 pc(s).	9683.608
1200	400	1102	393	1 pc(s).	9683.624
1200	600	1102	593	1 pc(s).	9683.626
1200	800	1102	793	1 pc(s).	9683.628

Design with gland made from insulating material

For enclosure width mm	For compartment height mm	Width mm	Height mm	Packs of	Model No.
600	150	502	143	1 pc(s).	9683.561
600	200	502	193	1 pc(s).	9683.562
600	300	502	293	1 pc(s).	9683.563
600	400	502	393	1 pc(s).	9683.564

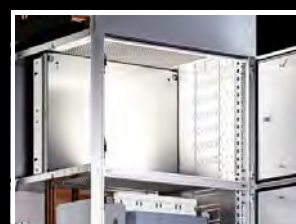

Power distribution

Compartment configuration

Form 1-4



Support frame

for DIN rail-mounted devices

Support frame set for accepting DIN rail-mounted devices (e.g. MCBs). The support rails are fastened with two mounting brackets to the compartment side panel. The cover is fastened to the support frame with knurled screws. In combination with functional space dividers, partial mounting plates and side panel modules, internal compartmentalisation in accordance with Form 2, 3 or 4 is possible.

Material:

- Support frame: Sheet steel, zinc-plated, passivated, 1.5 mm
- Cover: Sheet steel, spray finished, 1.5 mm

Supply includes:

- Support rails
- 2 mounting brackets
- 1 cover with cut-out
- Assembly parts

For enclosure width mm	For compartment height mm	No. of pitch units 17.5 mm	Packs of	Model No.
600	300	2 x 24	1 pc(s).	9683.763
800	300	2 x 36	1 pc(s).	9683.783

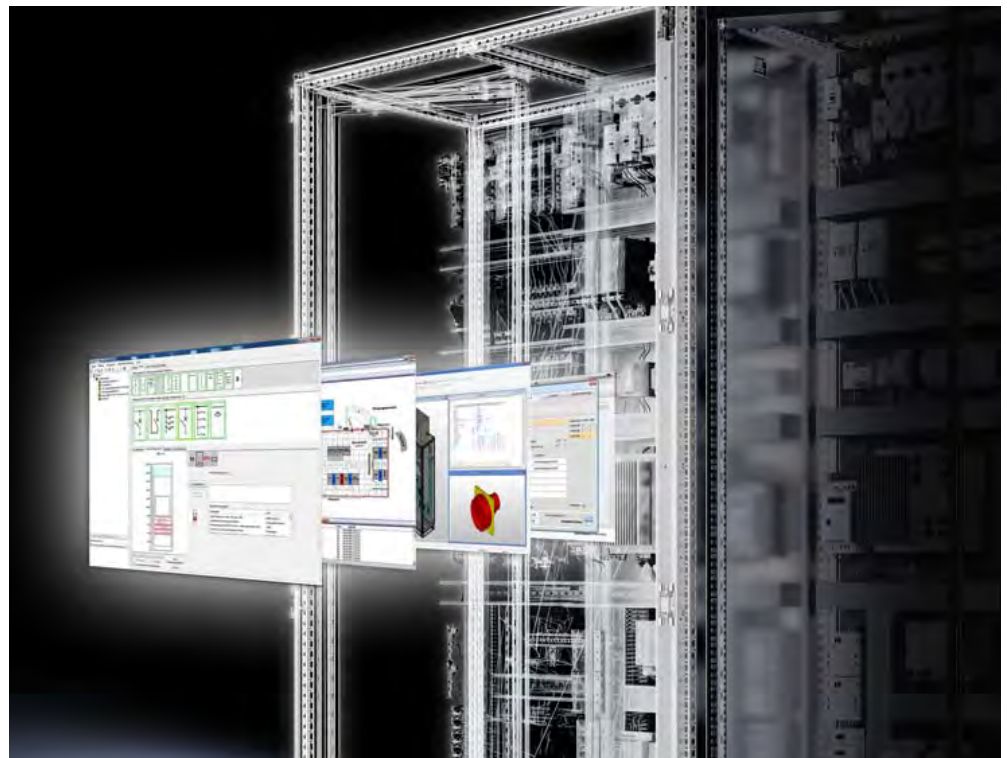

Certainty for engineering: optimum conversion and planning tools, see page 1160

Fuse-switch disconnecter section

Busbar support

for fuse-switch disconnecter section

Busbar supports for the distribution busbar system of the fuse-switch disconnecter section.

Material:

- Duroplastic polyester

Supply includes:

- Mounting bracket and screws

For busbars mm	Number of poles	Packs of	Model No.
60 x 10	3-pole 4-pole	1 pc(s).	9674.416
80 x 10	3-pole 4-pole	1 pc(s).	9674.418
100 x 10	3-pole 4-pole	1 pc(s).	9674.410



Also required:

- Busbars E-Cu, see page 342
- End support, see page 415



End support

for fuse-switch disconnecter section

End support for the distribution busbar system of the fuse-switch disconnecter section, for vertical support of the distribution busbar system with infeed from above.

Material:

- Duroplastic polyester

Supply includes:

- Mounting bracket and screws

For busbars mm	Number of poles	Packs of	Model No.
60 x 10	3-pole 4-pole	1 pc(s).	9674.436
80 x 10	3-pole 4-pole	1 pc(s).	9674.438
100 x 10	3-pole 4-pole	1 pc(s).	9674.430



Also required:

- Busbars E-Cu, see page 342



Cover

Set for distribution busbar

(Jean Müller fuse-switch disconnecter section)

To cover the distribution busbar system of a fuse-switch disconnecter section, designed to accommodate Jean Müller devices. The 150 mm high busbar and cable connection space covers shield the busbar compartment from the functional space so that it is safe from finger contact, with a protection category of IP 20.

Material:

- PVC, black

Supply includes:

- Set consisting of 12 busbar covers and cable connection space covers

For enclosure height mm	Packs of	Model No.
2000 2200	1 pc(s).	9674.380



Also required:

- Punched rail, see page 416



Fuse-switch disconnecter section



Punched rail

Set for cover, distribution busbar (Jean Müller fuse-switch disconnecter section)
Required for mounting the distribution busbar cover.

Material:

- Sheet steel, zinc-plated

Supply includes:

- Set consisting of 2 punched rails
- Assembly parts

Note:

- For 1 fuse-switch disconnecter section, 1 pack of punched rails is required.

For enclosure height mm	Packs of	Model No.
2000 2200	1 pc(s).	9674.381

Cover

for distribution busbar (ABB/Siemens fuse-switch disconnecter section)

To cover the distribution busbar system of a switch-disconnector-fuse section, designed to accommodate ABB (SlimLine) or Siemens (3NJ62) devices. The 200 mm high busbar compartment covers shield the busbar compartment from the functional space so that it is safe from finger contact, with a protection category of IP 20.

Material:

- PVC, black

Note:

- The cover may be ordered from ABB under model number NHP 407062R000X
- For enclosure height 2000 mm, a height of 1500 mm should be covered, and for enclosure height 2200 mm, a height of 1700 mm should be covered

Ri4Power accessories

Busbar system/wiring system

Copper spacer roll

for Maxi-PLS busbars and flat copper bars

For use as a universal spacer.

Material:

- E-Cu

Height mm	Diameter mm	Hole Ø mm	Packs of	Model No.
20	30	13	4 pc(s).	9676.503
20	40	13	4 pc(s).	9676.504
20	50	13	4 pc(s).	9676.505



Wiring trim panel

for VX

Inner front cover of the main busbar system with the option of mounting a 40 x 20 mm (WxD) wiring channel. Suitable for use in Ri4Power switchgear with 300 mm high front trim panels. Horizontal cable routing behind the front trim panels. Also supports the installation of support rails with DIN rail mounted devices.

Material:

- Sheet steel

Surface finish:

- Zinc-plated

Supply includes:

- 1 wiring trim panel, 3-part
- Assembly parts

Note:

- For vertical cable routing, compartment dividers enable the installation of a wiring channel, thanks to pre-punched cut-outs.

For enclosure width mm	Packs of	Model No.
600 800	1 pc(s).	9683.736
1000 1200	1 pc(s).	9683.738



Rittal – The System.

Faster – better – everywhere.

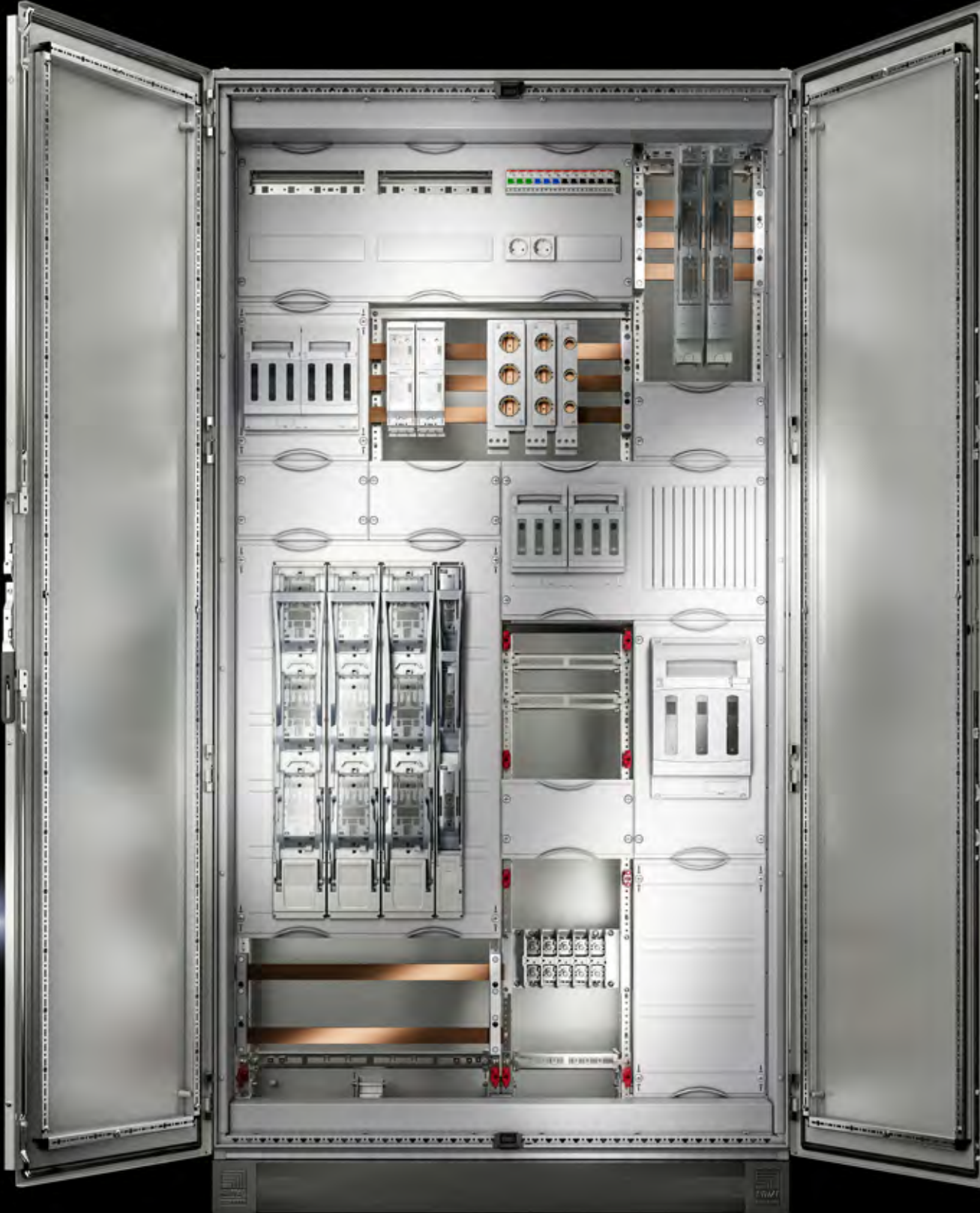

VX25 Ri4Power ISV distribution enclosures

Distribution enclosures

- Based on baying enclosure system VX25, see page 116
- Mounting kits, see page 420

Wall-mounted distributors

- Based on compact enclosure AX, see page 84
- Mounting kits, see page 420

Installation modules

- Easy mounting on support frame or support plate
- Individual combination and configuration
- Pitch pattern 150 x 250 mm
- Installation modules, see page 421

Power distribution components

- Bus-mounting fuse bases, see page 323
- NH fuse-switch disconnectors, see page 325
- NH slimline fuse-switch disconnectors, see page 335



Power distribution



ISV distribution enclosures

Mounting kits



ISV installation kit

for VX

For mounting ISV installation modules in the enclosure.

Material:

- Mounting frame holder: Sheet steel, zinc-plated
- Contact hazard protection: sheet steel, spray-finished
- Contact hazard protection, sides: PVC

Supply includes:

- Mounting aid support
- Contact hazard protection
- Assembly parts



Accessories:

- Cross rail ISV, see page 429
- Mounting angles ISV, see page 429
- Depth stay, see page 430
- Equipment support connectors, see page 430

For enclosure width mm	For enclosure height mm	For enclosure depth mm	Width units (WU) @ 250 mm	Height units (U) @ 150 mm	To fit Model No.	Note on Model No.	Packs of	Model No.
600	1800	400 500 600	2	11	8457.000/ 8684.000/ 8685.000/ 8686.000	Mounting angle 9666.711 and mounting plate 8612.400 are additionally required	1 pc(s).	9666.932
600	2000	400 500 600	2	12	8452.000/ 8604.000/ 8605.000/ 8606.000	Mounting angle 9666.712 and mounting plate 8612.400 are additionally required	1 pc(s).	9666.902
850	2000	400 600	3	12	9666.916/ 9666.956	Mounting angle 9666.712 and mounting plate 8612.400 are additionally required	1 pc(s).	9666.912
1100	2000	400 600	4	12	9666.926/ 9666.966	Mounting angle 9666.712, depth stay 9666.732 and mounting board 8612.400 are additionally required	1 pc(s).	9666.922



ISV installation kit

for AX

For mounting ISV installation modules in enclosures.

Material:

- Assembly kit: Sheet steel, zinc-plated
- Support rail: Sheet steel, zinc-plated
- Contact hazard protection: Sheet steel, spray-finished

Supply includes:

- Assembly kit
- Support rails
- Contact hazard protection
- Assembly parts



Also required:

- Mounting angles ISV, see page 429

For enclosure width mm	For enclosure height mm	For enclosure depth mm	Width units (WU) @ 250 mm	Height units (U) @ 150 mm	To fit Model No.	Packs of	Model No.
380	600	210	1	3	1008.X00/ 1038.X00	1 pc(s).	9666.801
500	700	250	1	4	1057.X00	1 pc(s).	9666.811
600	760	210	2	4	1012.X00/ 1076.X00	1 pc(s).	9666.821
600	1000	250	2	6	1090.X00	1 pc(s).	9666.831
600	1200	300	2	7	1260.X00	1 pc(s).	9666.841
1000	1200	300	3	7	1019.X00/ 1213.X00/ 1305.X00	1 pc(s).	9666.851

ISV distribution enclosures

Installation modules

Contact hazard protection module

For covering free installation areas. Cover is prepared for a lead seal.

Material:

– Cover: Polystyrene

Colour:

– RAL 7035

Supply includes:

– Assembly parts

Width mm	Height mm	Width units (WU) @ 250 mm	Height units (U) @ 150 mm	Packs of	Model No.
250	150	1	1	1 pc(s).	9666.000
250	300	1	2	1 pc(s).	9666.010
250	450	1	3	1 pc(s).	9666.020
250	600	1	4	1 pc(s).	9666.030
500	150	2	1	1 pc(s).	9666.040
500	300	2	2	1 pc(s).	9666.050
500	450	2	3	1 pc(s).	9666.060
500	600	2	4	1 pc(s).	9666.070
750	300	3	2	1 pc(s).	9666.053
750	450	3	3	1 pc(s).	9666.063
750	600	3	4	1 pc(s).	9666.073

Mounting plate module

Possible installation depth 105 - 140 mm. Cover is prepared for a lead seal.

Material:

– Cover: Polystyrene
– Mounting plate: Sheet steel, zinc-plated

Colour:

– RAL 7035

Supply includes:

– Assembly parts

Width mm	Height mm	Width units (WU) @ 250 mm	Height units (U) @ 150 mm	Dimensions mounting plate (W x H) mm	Packs of	Model No.
250	150	1	1	188 x 116	1 pc(s).	9666.080
250	300	1	2	188 x 266	1 pc(s).	9666.090
250	450	1	3	188 x 416	1 pc(s).	9666.100
250	600	1	4	188 x 566	1 pc(s).	9666.110
500	150	2	1	438 x 116	1 pc(s).	9666.120
500	300	2	2	438 x 266	1 pc(s).	9666.130
500	450	2	3	438 x 416	1 pc(s).	9666.140
500	600	2	4	438 x 566	1 pc(s).	9666.150
750	300	3	2	688 x 266	1 pc(s).	9666.133
750	450	3	3	688 x 416	1 pc(s).	9666.143

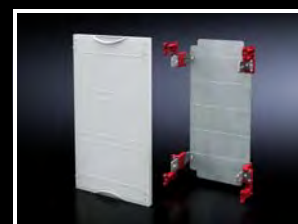

ISV distribution enclosures

Installation modules

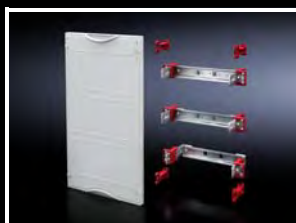

Support rail module

For installing terminal blocks, switchgear, etc. with support rails 35 x 15 mm. Adjustable on a 25 mm pitch pattern. Cover is prepared for a lead seal.

Material:

- Cover: Polystyrene
- Support rail: Sheet steel, zinc-plated

Colour:

- RAL 7035

Supply includes:

- Assembly parts



Accessories:

- Wiring bracket, see page 428

Width mm	Height mm	Width units (WU) @ 250 mm	Height units (U) @ 150 mm	Number of support rails	Packs of	Model No.
250	150	1	1	1	1 pc(s).	9666.160
250	300	1	2	2	1 pc(s).	9666.170
250	450	1	3	3	1 pc(s).	9666.180
250	600	1	4	4	1 pc(s).	9666.190
500	150	2	1	1	1 pc(s).	9666.200
500	300	2	2	2	1 pc(s).	9666.210
500	450	2	3	3	1 pc(s).	9666.220
500	600	2	4	4	1 pc(s).	9666.230
750	300	3	2	2	1 pc(s).	9666.213
750	450	3	3	3	1 pc(s).	9666.223

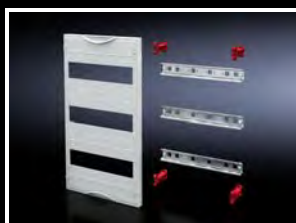

DIN rail mounted device module

To accommodate DIN rail mounted devices. With support rails 35 x 15 mm. Cover is prepared for a lead seal.

Material:

- Cover: Polystyrene
- Support rail: Sheet steel, zinc-plated

Colour:

- RAL 7035

Supply includes:

- Assembly parts



Accessories:

- Cover strip, see page 428

Width mm	Height mm	Width units (WU) @ 250 mm	Height units (U) @ 150 mm	Max. pitch units @ 18 mm	Number of cut-outs	Number of support rails	Packs of	Model No.
250	150	1	1	12	1	1	1 pc(s).	9666.240
250	300	1	2	24	2	2	1 pc(s).	9666.250
250	450	1	3	36	3	3	1 pc(s).	9666.260
250	600	1	4	48	4	4	1 pc(s).	9666.270
500	150	2	1	24	2	1	1 pc(s).	9666.280
500	300	2	2	48	4	2	1 pc(s).	9666.290
500	450	2	3	72	6	3	1 pc(s).	9666.300
750	300	3	2	72	6	2	1 pc(s).	9666.293
750	450	3	3	108	9	3	1 pc(s).	9666.303

ISV distribution enclosures

Installation modules

Connection terminal block

For connecting copper and aluminium conductors.
For laminated copper bars or solid and stranded conductors with a pressed wire end ferrule.

Material:

– Duroplastic

Colour:

– RAL 7035

Supply includes:

– Assembly parts

**Also required:**

- Contact hazard protection module, see page 421
- Mounting set, see page 423

**Assembly instruction:**

- Contact hazard protection module 9666.020 is additionally required to cover the connection terminal block



Rated current max. A	Number of poles	Connection of round conductors mm ²	Clamping area for laminated copper bars (W x H) mm	Packs of	Model No.
250	5-pole	16 - 150 2 x 16 - 70	17 x 21	1 pc(s).	9666.340
400	5-pole	50 - 240 2 x 25 - 120	25 x 21	1 pc(s).	9666.350

Mounting set

for connection terminal block

For attaching the connection terminal block to the frame of the ISV installation kit.

Material:

– Sheet steel, zinc-plated

Supply includes:

– Assembly parts



Width units (WU) @ 250 mm	Height units (U) @ 150 mm	Packs of	Model No.
1	3	1 pc(s).	9666.310

ISV distribution enclosures

Installation modules



NH fuse-switch-disconnector module

Suitable for accommodating NH fuse-switch disconnectors for mounting plate assembly. Cover is prepared for a lead seal.

Material:

- Cover: Polystyrene
- Cross member: Sheet steel

Colour:

- RAL 7035

Supply includes:

- Assembly parts

 **Assembly instruction:**

- When using the NH fuse-switch disconnector 2 x size 2 (9344.210/.230/.250) or 1 x size 3 (9344.310/.330/.350), the disconnector cross-member 9666.420 and contact hazard protection module 9666.060 should be used as the module unit

 **Accessories:**

- Blanking cover, see page 428

Width mm	Height mm	Width units (WU) @ 250 mm	Height units (U) @ 150 mm	For size	To fit Model No.	Packs of	Model No.
250	300	1	2	2 x size 00	9344.000/ 9344.010/ 9344.020/ 9344.030/ 9344.040/ 9344.050	1 pc(s).	9666.380
500	300	2	2	4 x size 00	9344.000/ 9344.010/ 9344.020/ 9344.030/ 9344.040/ 9344.050	1 pc(s).	9666.390
250	450	1	3	1 x size 1	9344.100/ 9344.110/ 9344.130/ 9344.150	1 pc(s).	9666.400
250	450	1	3	1 x size 2	9344.210/ 9344.230/ 9344.250	1 pc(s).	9666.410



Disconnector cross member

for NH fuse-switch disconnectors

Suitable for accommodating NH fuse-switch disconnectors for mounting plate assembly.

Material:

- Sheet steel

Supply includes:

- Assembly parts

Note:

- When using the disconnector cross-member, contact hazard protection module 9666.060 is additionally required

 **Also required:**

- Contact hazard protection module, see page 421

Width mm	Height mm	Width units (WU) @ 250 mm	Height units (U) @ 150 mm	For size	To fit Model No.	Packs of	Model No.
500	450	2	3	2 x size 2 1 x size 3	9344.210/ 9344.230/ 9344.250/ 9344.310/ 9344.330/ 9344.350	1 pc(s).	9666.420

ISV distribution enclosures

Installation modules

NH slimline fuse-switch-disconnector module

For NH slimline fuse-switch disconnectors, sizes 00 to 3 (3-pole, 100/185 mm bar centre distance).

Material:

- Cover: Polystyrene
- Holder: Fibreglass-reinforced plastic

Colour:

- RAL 7035

Supply includes:

- Assembly parts

Note:

- In order to ensure problem-free cable connection, a contact hazard protection module or an N/PE busbar module must be installed above or below the NH slimline fuse-switch disconnector modules.



Also required:

- Busbars E-Cu, see page 342



Accessories:

- Contact hazard protection module, see page 421
- Busbar module N/PE, see page 426



Width mm	Height mm	Width units (WU) @ 250 mm	Height units (U) @ 150 mm	For size	To fit Model No.	For busbar mm	Bar centre distance mm	Packs of	Model No.
250	450	1	3	3 x size 00	9346.020/ 9346.030	40 x 10	100	1 pc(s).	9666.570
500	450	2	3	6 x size 00	9346.020/ 9346.030	40 x 10	100	1 pc(s).	9666.580
500	750	2	5	8 x size 00 4 x size 1 4 x size 2 4 x size 3	9677.XXX	60 x 10	185	1 pc(s).	9666.550
750	450	3	3	10 x size 00	9346.020/ 9346.030	40 x 10	100	1 pc(s).	9666.583
750	750	3	5	12 x size 00 6 x size 1 6 x size 2 6 x size 3	9677.XXX	60 x 10	185	1 pc(s).	9666.560

Circuit-breaker module

Suitable for accommodating standard moulded-case circuit-breakers from ABB, Eaton, Schneider Electric and Siemens. Cover is prepared for a lead seal.

Material:

- Cover: Polystyrene
- Support rail: Sheet steel, zinc-plated

Colour:

- RAL 7035

Supply includes:

- Assembly parts

Width mm	Height mm	Width units (WU) @ 250 mm	Height units (U) @ 150 mm	For switchgear make (model)	Packs of	Model No.
250	300	1	2	ABB (T1, T2, T3) Eaton (NZM1, NZM2, BZM B1, BZM B2) Schneider Electric (NSX100, NSX160, NSX250) Siemens (3RV13 53, VL160(X), VL250, VT1, VT2)	1 pc(s).	9666.430
500	450	2	3	ABB (T4, T5) Eaton (NZM3) Schneider Electric (NSX400, NSX630) Siemens (3RV1.6., 3RV1.7., VL400, VL630, VT3)	1 pc(s).	9666.440



ISV distribution enclosures

Installation modules



Meter mounting board module

Open module for internal measurements. Clearance depth available for meter installation 170 mm.

Design:

- Attachment rails to accommodate a meter

Material:

- Meter mounting board: Polystyrene
- Mounting rails: sheet steel, zinc-plated

Colour:

- RAL 7035

Supply includes:

- Assembly parts

Note:

- The meter mounting board module does not comply with meter mounting board standard DIN 43 870/VDE 0603 and does not meet the conditions for total insulation. Use in unmetered areas only by arrangement with the local electricity supply company.

 **Assembly instruction:**

- 1 contact hazard protection module / DIN rail-mounted device module or support rail module with 1 WU and at least 1 U is required both above and below the meter mounting board module

 **Accessories:**

- Contact hazard protection module, see page 421
- Support rail module, see page 422
- DIN rail mounted device module, see page 422

Width mm	Height mm	Width units (WU) @ 250 mm	Height units (U) @ 150 mm	Packs of	Model No.
250	450	1	3	1 pc(s).	9666.640



Busbar module N/PE

For attaching busbars 12 x 5/10 mm, 20 x 5/10 and 30 x 5/10 mm for N and PE. Cover is prepared for a lead seal.

Material:

- Cover: Polystyrene
- Holder: Fibreglass-reinforced plastic
- Support rail: Sheet steel, zinc-plated

Colour:

- RAL 7035

 **Also required:**

- Busbars E-Cu, see page 342

Width mm	Height mm	Width units (WU) @ 250 mm	Height units (U) @ 150 mm	Packs of	Model No.
250	300	1	2	1 pc(s).	9666.590
500	300	2	2	1 pc(s).	9666.600
750	300	3	2	1 pc(s).	9666.603

ISV distribution enclosures

Installation modules

Busbar module

for fuse elements

For assembling bus-mounting fuse bases E18, E27, E33 and D-Switch as well as NH fuse-switch disconnectors, sizes 000 and 00 (3-pole, 60 mm bar centre distance).

Material:

- Cover: Polystyrene
- Holder: Fibreglass-reinforced plastic

Colour:

- RAL 7035

Supply includes:

- Assembly parts



Also required:

- Busbars E-Cu, see page 342



Accessories:

- Blanking cover, see page 428



Width mm	Height mm	Width units (WU) @ 250 mm	Height units (U) @ 150 mm	To fit Model No.	For busbar mm	Packs of	Model No.
250	300	1	2	3418.010/ 3427.010/ 3433.010/ 3431.020/ 3431.030/ 3431.035/ 9340.950/ 9343.000/ 9343.020/ 9343.040	30 x 10	1 pc(s).	9666.520
500	300	2	2	3418.010/ 3427.010/ 3433.010/ 3431.020/ 3431.030/ 3431.035/ 9340.950	30 x 10	1 pc(s).	9666.530
750	300	3	2	3418.010/ 3427.010/ 3433.010/ 3431.020/ 3431.030/ 3431.035/ 9340.950	30 x 10	1 pc(s).	9666.533

ISV distribution enclosures

Accessories



Cover strip

for DIN rail mounted device module

For sealing unused component cut-outs in DIN rail mounted device modules, max. 12 pitch units (12 x 18 mm), divisible every 9 mm.

Material:

– ABS

Colour:

– RAL 7035

Packs of	Model No.
5 pc(s).	9666.650



Blanking cover

for busbar module

For sealing unused cut-outs. Width: 16 – 34 mm, variable.

Material:

– Polypropylene

Colour:

– RAL 7035

Width mm	To fit Model No.	Packs of	Model No.
34	9666.520/ 9666.530/ 9666.533	10 pc(s).	9666.660



Blanking cover

for NH fuse-switch-disconnector module

For sealing unused cut-outs (size 00).

Material:

– PVC

Colour:

– RAL 7035

Width mm	To fit Model No.	Packs of	Model No.
117	9666.380/ 9666.390	1 pc(s).	9666.665



Wiring bracket

For tool-free attachment to the support rail 35 x 15 mm, for cable entry at the rear of support rail modules.

Material:

– Polyamide

Packs of	Model No.
10 pc(s).	9666.670

ISV distribution enclosures

Accessories

Depth extension frame

for NH fuse-switch disconnectors size 00

For extending the depth of the contact hazard protection cover. Allows unrestricted connection of NH fuse-switch disconnectors, size 00 (3-pole, 60 mm bar centre distance).

Material:

– Polystyrene

Colour:

– RAL 7035

Supply includes:

– Assembly parts

Note:

– NH fuse-switch disconnectors size 00 with covers and depth extension frame cannot be used in conjunction with other equipment

Width mm	Height mm	Width units (WU) @ 250 mm	Height units (U) @ 150 mm	Packs of	Model No.
250	300	1	2	1 pc(s).	9666.680



Cross rail ISV

for VX

For horizontal sub-division of the support frame in the enclosure.

Material:

– Sheet steel

Surface finish:

– Zinc-plated

Width mm	Width units (WU) @ 250 mm	Packs of	Model No.
500	2	2 pc(s).	9666.722
750	3	2 pc(s).	9666.723
1000	4	2 pc(s).	9666.724



Mounting angles ISV

for VX

For vertical sub-division of the support frame in the enclosure.

Material:

– Sheet steel

Surface finish:

– Zinc-plated

Height mm	Height units (U) @ 150 mm	Packs of	Model No.
300	2	2 pc(s).	9666.702
450	3	2 pc(s).	9666.703
600	4	2 pc(s).	9666.704
750	5	2 pc(s).	9666.705
900	6	2 pc(s).	9666.706
1050	7	2 pc(s).	9666.707
1650	11	2 pc(s).	9666.711
1800	12	2 pc(s).	9666.712



Accessories:

– Equipment support connectors, see page 430

Mounting angles ISV

for AX

For vertical sub-division of the support frame in the enclosure.

Material:

– Sheet steel

Surface finish:

– Zinc-plated

Height mm	Height units (U) @ 150 mm	Packs of	Model No.
450	3	2 pc(s).	9666.753
600	4	2 pc(s).	9666.754
900	6	2 pc(s).	9666.756
1050	7	2 pc(s).	9666.757



ISV distribution enclosures

Accessories



Depth stay

for installation kit ISV

For attaching the installation kit in the enclosure.

Material:

- Sheet steel

Surface finish:

- Zinc-plated

Supply includes:

- Assembly parts

For enclosures	For enclosure depth mm	To fit Model No.	Packs of	Model No.
VX	400 500 600	9666.902/ 9666.912/ 9666.922/ 9666.932	2 pc(s).	9666.732



Equipment support connectors

for mounting angles ISV

For connecting 2 mounting angles. Increases the stability of the frame structure.

Material:

- T-section: Aluminium

Supply includes:

- Assembly parts

To fit Model No.	Packs of	Model No.
9666.702/ 9666.703/ 9666.704/ 9666.705/ 9666.706/ 9666.707/ 9666.711/ 9666.712	4 pc(s).	9666.740

Wall-mounted distributor

Based on compact enclosure AX, see page 78



Rittal Energy and Power Solutions

End-to-end solutions from generation to consumer

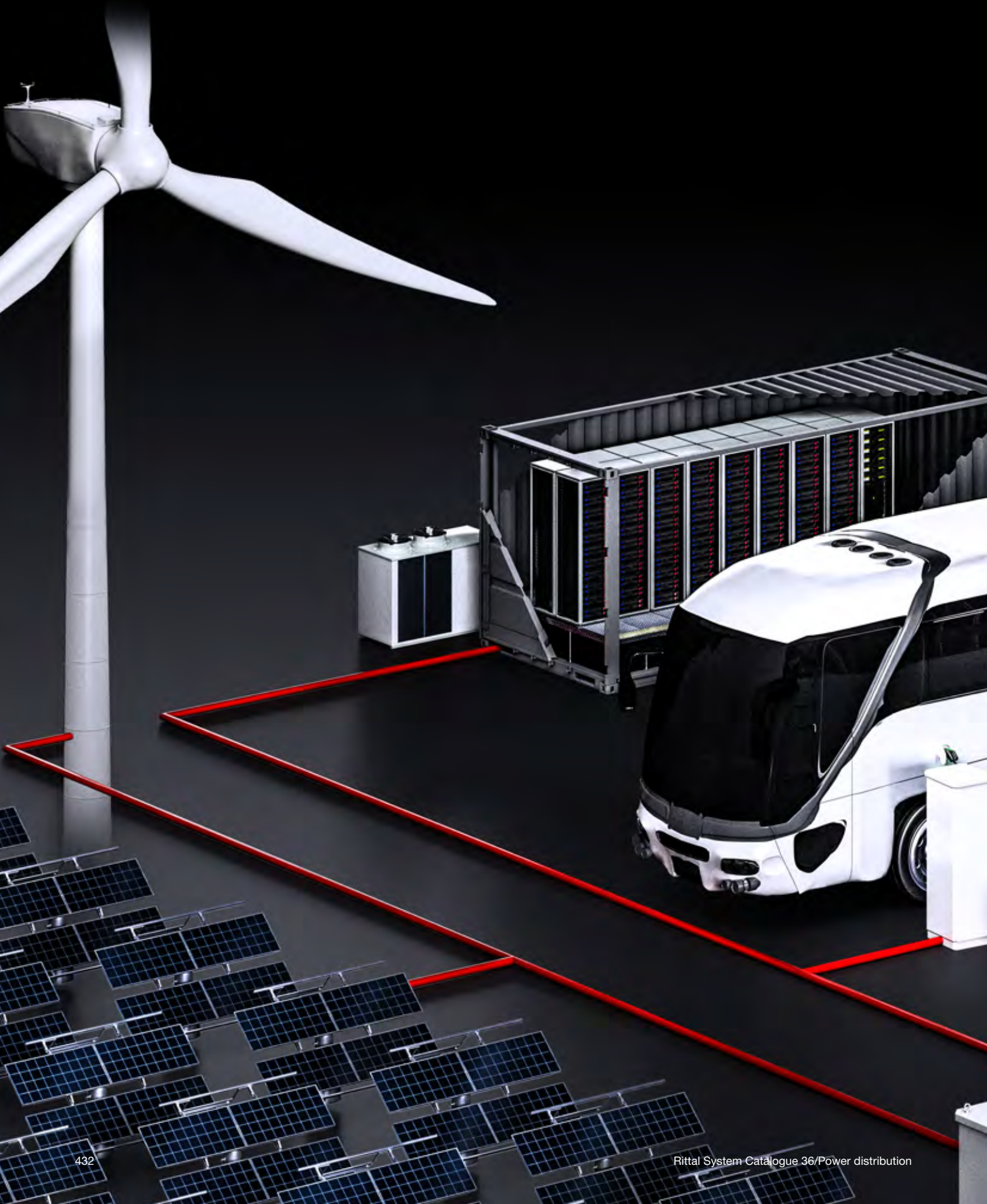

Renewable energies

- Reliable energy generation and infeed, together with smart connectivity, are the key to the new energy world, where energy solutions must transcend individual sectors.
- There is a demand for solutions with global availability and internationally recognised approvals plus effective protection from a wide range of ambient conditions.
- Plant and systems engineering needs solutions to create significant competitive advantages through energy efficiency plus time and money savings.



Power distribution

Energy storage solutions

- Battery stores can help to stabilise the power supply in the renewable energies environment, e.g. by means of peak load management, frequency retention and an uninterruptible power supply (UPS).
- The different battery module designs available on the market necessitate a variable solution for building energy storage systems. The standardised modular system offers the required degree of variability and supports the integration of 482.6 mm (19") battery types and other variants using rails and heavy-duty shelves.
- The range of products includes indoor, outdoor and even container solutions. Our standard products will help to reduce your planning and production costs.



Charging infrastructure

- Charging centres generally comprise a scalable number of charging pillars, the requisite backend infrastructure, plus a low-voltage main distributor.
- We usually distinguish between normal charging in the range < 50 kW (primarily AC technology), fast charging from 50 kW upwards, and high-power charging > 150 kW (DC technology).



Renewable energies

Flexible enclosure solutions for wind power and photovoltaics



Rotor hub / nacelle

- Rittal provides suitable enclosure and case systems for all areas of wind farms, based on impressive modular technology.
- Control cabinets in the nacelle and pitch enclosure directly in the rotor hub, to reliably withstand even the highest dynamic forces

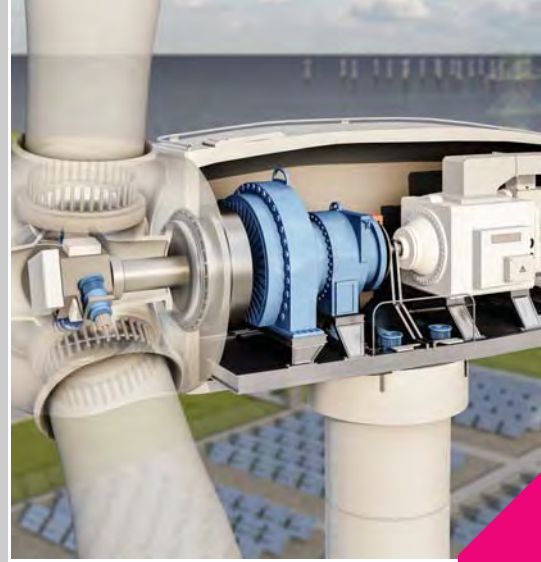

Tower

- The components we use are modular, efficient and low-maintenance, for fast (and in some cases, customised) configuration.
- Complete system solutions for powerful frequency converters including climate control



Central inverter

- There is a growing use of inverter systems under difficult ambient conditions.
- Smart standard solutions offer a high level of physical protection for the enclosure, equipped with power distributor and climate control.



Solar panel

- Compact enclosures in the AX and KX series are ideal for housing the electronics for solar tracking systems or as a general junction box. The small and compact enclosures offer simpler, faster assembly coupled with greater flexibility and security.



Renewable energies



Application		Enclosure	
System solution		<p>Rittal enclosure solutions provide optimum protection for your components.</p> <ul style="list-style-type: none"> ■ Protection category-tested enclosure technology to IP, IK, RC ■ Accredited in-house laboratory ■ 3-phase surface treatment for maximum corrosion protection ■ Choice of materials depending on the climate and requirement profile: Aluminium, stainless steel, sheet steel ■ EMC protection ■ Static load capacity up to 14,000 N 	
		Requirements	
Wind energy	Rotor hub	<ul style="list-style-type: none"> ■ Dynamic loads ■ Walkable ■ Easy access 	<ul style="list-style-type: none"> ■ Small and compact enclosures, material: sheet steel, stainless steel, from page 43
	Nacelle	<ul style="list-style-type: none"> ■ Dynamic loads ■ Thermal management ■ Prevent condensation 	<ul style="list-style-type: none"> ■ Large enclosure, material: Sheet steel, from page 116
	Tower	<ul style="list-style-type: none"> ■ Confined space ■ Thermal management 	<ul style="list-style-type: none"> ■ Large enclosure, material: Sheet steel, from page 116
Photovoltaics	Central inverter	<ul style="list-style-type: none"> ■ Weather influences ■ Environmental conditions 	<ul style="list-style-type: none"> ■ Large outdoor enclosure, material: Stainless steel, aluminium, from page 268
	Solar panel		<ul style="list-style-type: none"> ■ Small enclosure/PK, material: Plastic, sheet steel, from page 43



Power distribution

	Climate control	Power distribution	Accessories	Quality management
	<p>Efficient, innovative climate control solutions provide reliable protection for your power electronics.</p> <ul style="list-style-type: none"> ■ Fans, cooling units and heaters for temperature control of the built-in equipment. ■ Individual design of the required climate control using our Therm software 	<p>Rittal offers a modular system for demand-based power distribution (from page 277).</p> <ul style="list-style-type: none"> ■ Distribution and protection of the power supply focussing on standardisation and availability ■ Planning and design of low-voltage switchgear to IEC 61 439 with design certificate using Power Engineering software 		<p>Rittal will support you from day one:</p> <ul style="list-style-type: none"> ■ Project planning of technical specifications ■ Prototype assembly, testing and simulations ■ Manufacturing and assembly ■ Warehousing service and on-time delivery ■ Your own personal point of contact throughout the entire project
	<ul style="list-style-type: none"> ■ Fan-and-filter units with protection category IP 54 as standard. More products from page 456 ■ Fan-and-filter units and Blue e+ (energy-efficient) More products from page 456 ■ Roof-mounted cooling unit; doors or side panels and escape routes are kept free More products from page 498 ■ TopTherm Blue e wall-mounted cooling unit, NEMA 4X, also as IloT bundle ■ Outdoor cooling unit, from page 496 More products from page 477 ■ Fan-and-filter units ■ Thermoelectric coolers More products from page 456 	<ul style="list-style-type: none"> ■ Modular system for low-voltage switchgear with design verification to IEC 61 439 up to 1600 A for DC and AC applications, from page 446 ■ Rated current < 125 A RiLine Compact, from page 285 ■ Rated current < 250 A Mini-PLS, from page 294 ■ Rated current < 1600 A RiLine PLS, from page 300 ■ Rated current < 6300 A VX25 Ri4Power, from page 314 	<ul style="list-style-type: none"> ■ Earthquake kit, from page 1032 ■ EMC, from page 1028 ■ Monitoring, from page 799 ■ IoT interface, from page 554 ■ Base/plinths, from page 880 ■ Lock systems, from page 933 ■ Rain canopies, from page 958 ■ Interior installation, mounting plates, bar systems, from page 970 ■ Industry-specific accessories available on request 	<p>Accredited Rittal test laboratory</p> <ul style="list-style-type: none"> ■ Simulation of climatic conditions ■ Dynamic and static load tests ■ 3D measurement ■ Corrosion testing ■ Electrical safety and function tests ■ Software tests ■ Performance testing of chillers, cooling units and heat exchangers

Energy Storage Solutions (ESS)

The perfect system solution for every storage task



Heavy-duty shelves for loads up to 100 kg per level

- Rittal's modular product system includes standard components for flexible assembly of an infrastructure with a battery energy storage system (BESS).
- Battery types not compliant with the 482.6 mm (19") standard may be integrated, e.g. using heavy-duty shelves with a load-bearing capacity of up to 100 kg.

Integration with the 482.6 mm (19") rack mounting system

- The technology behind the 482.6 mm (19") standard is exceptionally assembly-friendly and supports simple integration of these battery types.
- For larger battery capacities, Rittal enclosures may be bayed.

Efficient monitoring

- For seamless monitoring of performance and risk of failure, ESS may be combined with CMC and RiZone for the monitoring system.
- Web connectivity is provided via the Rittal IoT interface.

Efficiency in plant design

- Lithium ion batteries have a specific thermal operating window which must be observed for safety reasons. Depending on the installation site and use of the system, therefore, a range of design features from active ventilation through to climate control may be required.
- Rittal offers FEM and CFD analyses to represent your individual project in its specific situation, so that you can gauge which concepts are viable and which are not.



Power distribution

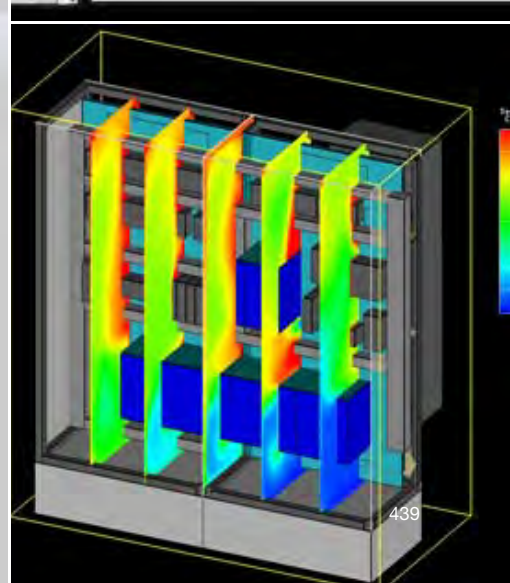
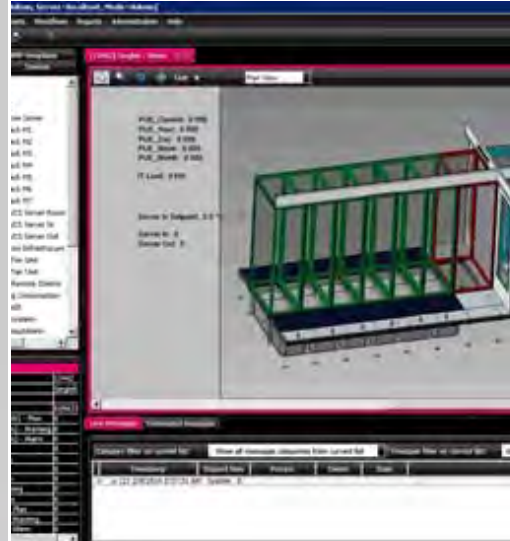

Energy storage solutions



Type	Enclosures			Climate control	
	VX25 rack system	Outdoor enclosure system	Container	Wall-mounted cooling unit Blue e+	Roof-mounted cooling unit Blue e+
System solution	The modular VX25 enclosure system is available in a range of sizes, both as a standalone rack and as a bayable solution. Our extensive range of accessories supports a broad range of solutions. With a weight capacity of 1500 kg, all standard battery types may be integrated.	Identical system platform in the outdoor sector as for IE or IT enclosure systems. Additionally with weather canopy, with projection on all sides. The double-walled design reduces the influence of sunlight. The open frame structure offers installation benefits. Also available as a baying variant.	On a project-specific basis, we offer 20ft and 40ft containers with up to 18/36 bays. Where required, these may be designed with suitable climate control.	Our energy-efficient Blue e+ wall-mounted cooling units ensure the correct temperature inside the enclosure. The outputs range from 1.6 to 6 kW. Their unique multi-voltage capability makes them suitable for international use. The cooling units are IoT-compatible and support modern condition monitoring.	Our energy-efficient Blue e+ roof-mounted cooling units ensure the correct temperature inside the enclosure. The output is 1.3 kW. Their unique multi-voltage capability makes them suitable for international use. The cooling units are IoT-compatible and support modern condition monitoring.
Approvals	CSA, DNV-GL, UL and C-UL	–		CE, TÜV-tested safety, UL/cUL, UL/cUL-FTTA, EAC	CE, TÜV-tested safety, UR/cUR, EAC
482.6 mm (19') configuration	Indoor	■	–	■	■
	Outdoor	–	■	–	–
Heavy-duty shelf	Indoor	■	–	■	■
	Outdoor	–	■	–	–
From page	116	263	On request	486	504



	Climate control	Power distribution	Interior installation	Accessories	
	Outdoor cooling unit	Busbars	Component shelf for frame attachment	Adaptor section, 482.6 mm (19')	Slide rails, static installation for VX IT
	Useful cooling output 1500 W, temperature control via e+ controller on the rear of the cooling unit. For universal attachment to outdoor enclosures for external, partial internal and full internal mounting. Average 75% energy savings thanks to speed-regulated components and heat pipe technology. Multi-voltage capability for global use. In conjunction with the IoT interface, the cooling unit can be networked and digitalised	Flexible power distribution solutions, highly adaptable up to 6300 A. Project planning is child's play with the user-friendly Power Engineering software.	Mounting bolts / mounting rails may be installed on a 25 mm pitch pattern pattern in the enclosure depth. For frame attachment, for installation in enclosures without 482.6 mm (19') accommodation. Load capacity up to 100 kg.	The adaptor mounting angles are available for enclosure heights 1600 mm (33 U), 1800 mm (38 U) and 2000 mm (42 U). The 482.6 mm (19') measurement applies when mounting on the frame of 600 mm wide enclosures. Depth-offset installation in 600 mm wide enclosures is supported using punched sections with mounting flanges, 18 x 64 mm.	For mounting between the front and rear mounting levels. To support heavy installed equipment. Side system punchings for mounting accessories and cooling components that expel to the side. Load capacity up to 80 kg static load.
	International approvals (cULus Listed, cULus FTTA, CE and EAC)	–	–	–	–
	–	■	–	■	■
	■	■	–	■	■
	–	■	■	–	–
	■	■	■	–	–
	497	281	1006	1080	1086

Charging infrastructure

System solutions to meet the challenges of a charging infrastructure



Normal charging

- Normal charging refers to the output category below 22 kW, primarily with AC voltage. The charge control may be accommodated in the charging pillar itself or in a backend infrastructure supplying multiple charging pillars simultaneously. Typical application areas include company car parks, supermarkets, hotels or multi-storey car parks where vehicles are parked for long periods and therefore have sufficient time to charge the battery.



Power distribution

Quick charging

- Quick charging refers to an output category of more than 22 kW. Quick charging is primarily achieved with DC voltage. As with normal charging, the charge control may be accommodated in the charging pillar itself or in a backend infrastructure supplying multiple charging pillars. Once again, typical applications include supermarkets, hotels and multi-storey car parks where the electric vehicles are parked for long periods and therefore have time to charge the battery.



High-power charging

- High-power charging is always DC-based and in the output category of above 150 kW. The most common applications are service areas, bus stops and fuel stations where a quick recharge of the vehicle battery is needed. The enclosures must provide protection from harsh environmental conditions as well as access control.



Charging infrastructure



Application		Enclosures		Accessories
System solution		Rittal enclosure solutions provide optimum protection for your components. <ul style="list-style-type: none"> ■ Protection category-tested enclosure technology to IP, IK, RC ■ Accredited in-house laboratory ■ 3-phase surface treatment for maximum corrosion protection ■ Choice of materials depending on the climate and requirement profile: Aluminium, stainless steel, sheet steel ■ EMC protection ■ Static load capacity up to 14,000 N 		
	Construction	Front end/charging pillar	Backend/infrastructure	
Normal charging <ul style="list-style-type: none"> ■ Company car park ■ Supermarket ■ Multi-storey car park ■ Hotel ■ Restaurant 	AC 1 charging point (< 22 kW)	<ul style="list-style-type: none"> ■ Compact enclosures AX, from page 84 ■ Stainless steel (HD), from page 217 	<ul style="list-style-type: none"> ■ Toptec, from page 270 ■ New Basic, from page 268 ■ Baying systems VX25, from page 116 	<ul style="list-style-type: none"> ■ Base/plinths, from page 880 ■ Lock systems, from page 933 ■ Rain canopies, from page 958 ■ Interior installation, mounting plates, 482.6 mm (19) frame, bar systems, from page 970 ■ System light, from page 1014 ■ EMC, from page 1028 ■ Cable entry/cable management, from page 1044
	AC n charging points (< 22 kW)	<ul style="list-style-type: none"> ■ Stainless steel (HD), from page 217 		
Quick charging <ul style="list-style-type: none"> ■ Supermarket ■ Multi-storey car park ■ Hotel ■ Restaurant 	DC 1 charging point	<ul style="list-style-type: none"> ■ Compact enclosures, from page 84 ■ Stainless steel (HD), from page 217 ■ Toptec, from page 270 ■ New Basic, from page 268 ■ Baying systems VX25, from page 116 		
	DC n charging points	<ul style="list-style-type: none"> ■ Compact enclosures AX, from page 84 ■ Toptec, from page 270 ■ New Basic, from page 268 ■ Baying systems VX25, from page 116 		
High-power charging <ul style="list-style-type: none"> ■ Service area ■ Bus stop 	DC-HPC (> 150 kW)	<ul style="list-style-type: none"> ■ Compact enclosures AX, from page 84 ■ Toptec, from page 270 ■ New Basic, from page 268 ■ Baying systems VX25, from page 116 	<ul style="list-style-type: none"> ■ Toptec, from page 270 ■ New Basic, from page 268 ■ Baying systems VX25, from page 116 	

Other enclosure variants available on request (emobility@rittal.de)



Climate control	Power distribution
<p>A charging centre may require various forms of climate control.</p> <ul style="list-style-type: none"> ■ Fans, cooling units and heaters for temperature control of the built-in equipment. ■ Chillers for water cooling of the charging cable in the HPC sector or components with liquid cooling inside the enclosure ■ Individual design of the required climate control using Therm software 	<p>Rittal offers a modular system for demand-based power distribution.</p> <ul style="list-style-type: none"> ■ Distribution and protection of the power supply focussing on standardisation and availability ■ Power Engineering software is used to plan and design low-voltage switchgear to IEC 61 439 with design verification, from page 446
<ul style="list-style-type: none"> ■ Heaters, from page 530 ■ Passive cooling: TopTherm fan-and-filter units, from page 456 ■ Protective canopies, from page 958 ■ Active: Thermoelectric coolers, from page 474 ■ Cooling units, from page 473 ■ Liquid cooling, from page 509 ■ Outdoor cooling unit, from page 496 ■ Accessories: IoT interface, from page 554 	<ul style="list-style-type: none"> ■ Rated current < 125 A RiLine Compact, from page 282 ■ Rated current < 250 A Mini-PLS, from page 294 ■ Rated current < 1600 A RiLine PLS, from page 299 ■ Rated current < 6300 A VX25 Ri4Power, from page 361

Power distribution software

Configurators/tools/CAD data

Power distribution

The VX25 Power Engineering planning software sets brand new standards when planning low-voltage switchgear. The Web-based tool guides users quickly and efficiently through the planning process in simple, logical steps.



VX25 Power Engineering

Efficient planning of low-voltage switchgear

From plant configuration, to calculation of the copper bars, through to generation of the design verification to IEC 61 439.

Benefits:

- The web-based application ensures that planning data is always up-to-date
- Parts list creation and assembly based on a specific set of rules
- Automatic calculation and documentation of the copper busbars
- Generation of a design verification to IEC 61 439

Note:

- Download free at www.rittal.com/software

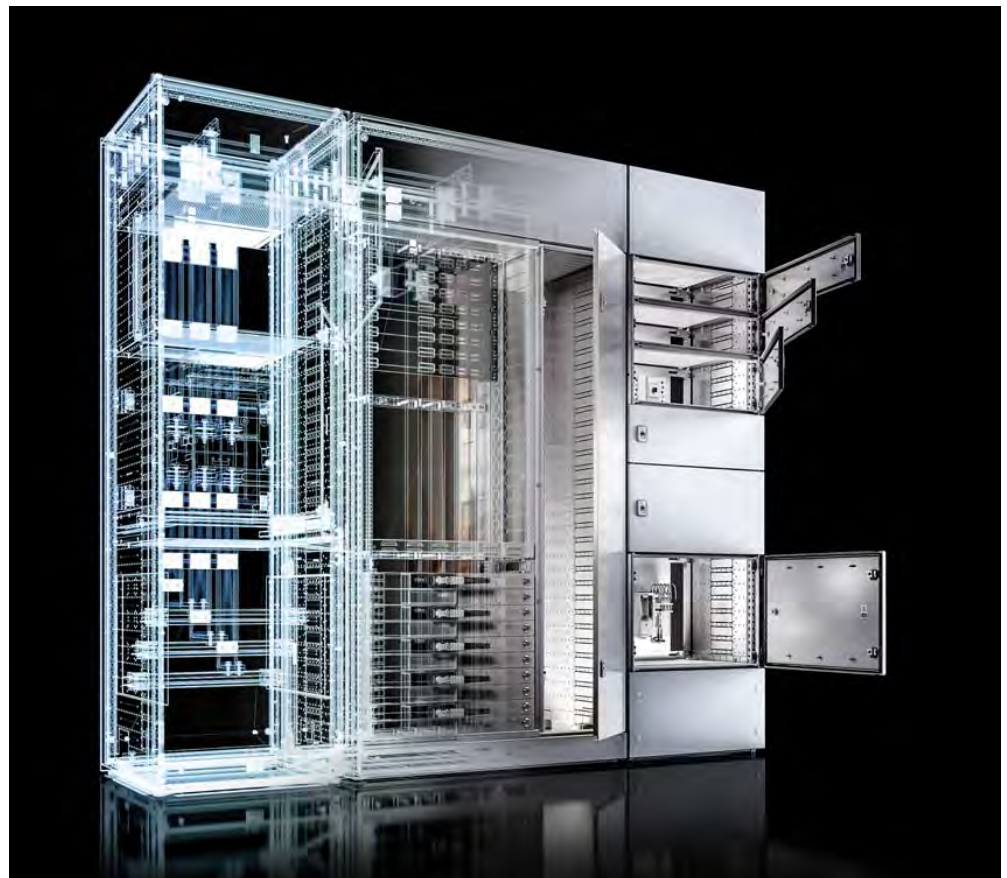

Rittal Automation Systems

High productivity levels and consistent optimisation of all process steps, from page 561

Rittal – The System.

Faster – better – everywhere.



ENCLOSURES

POWER DISTRIBUTION

CLIMATE CONTROL

FRIEDHELM LOH GROUP

X-ON Electronics

Largest Supplier of Electrical and Electronic Components

Click to view similar products for [Fuse Holder](#) category:

Click to view products by [Rittal](#) manufacturer:

Other Similar products are found below :

[0031.1351.01](#) [6R30A1B](#) [6SC30A2IC](#) [F30A3S](#) [F600A3B](#) [80910030](#) [80910080](#) [9-3557-GP REV A](#) [HFH-1](#) [RF30A1S](#) [RF30A2B](#) [RF30A3SP](#)
[15600-08-10](#) [15602-04-08-21](#) [HTJ-LES-FUSE](#) [RTMF-SC](#) [2602](#) [2650](#) [178.000100](#) [178.000200](#) [T30A2B](#) [G4PB8](#) [2660](#) [HKP-CCHH](#)
[R6F30A2S](#) [341001A](#) [345621A](#) [348670](#) [CVRMCC](#) [4202](#) [4408](#) [4532](#) [4537](#) [HPC](#) [55900008011](#) [32NNL](#) [345602-010](#) [345603-010](#) [345612](#)
[345903A](#) [3578](#) [3833-5](#) [3833-7](#) [3992](#) [4393](#) [4409](#) [4522](#) [4574](#) [02800031Z](#) [ESFH04/HTCC35M](#)