



RVT50HQTNWC00-B

IPS RGB 5.0" LCD TFT Datasheet

Rev.1.0

2020-08-10

ITEM	CONTENTS	UNIT
LCD Type	TFT/Transmissive/Normally black/IPS	/
Size	5.0	Inch
Viewing Direction	Free	/
Outside Dimensions (W × H × D)	136.00 × 92.80 × 5.40	mm ³
Active Area (W × H)	108.0 × 64.8	mm ²
Pixel Pitch (W × H)	0.135 × 0.135	mm ²
Resolution	800 (RGB) × 480	/
Brightness	850	cd/m ²
LCD Interface Type	RGB	/
Color Depth	16.7 M	/
Pixel Arrangement	RGB Vertical Stripe	/
LCD Driver	ST7262-G4	/
With/Without Touch	With Projected Capacitive Touch Panel	/
CTP Driver	ILI2132A	/
Touch Interface	USB /I2C/ Optional UART	/
Bonding Technology	Optical Bonding	/
Weight	TBD	g

Note 1: RoHS compliant

Note 2: LCM weight tolerance: ± 5%.

REVISION RECORD

REVNO.	REVDATE	CONTENTS	REMARKS
1.0	2020-08-11	Initial Release	

CONTENTS

REVISION RECORD.....	2
CONTENTS	2
1 MODULE CLASSIFICATION INFORMATION	3
2 MODULE DRAWING.....	4
3 ABSOLUTE MAXIMUM RATINGS.....	5
4 ELECTRICAL CHARACTERISTICS.....	5
5 BACKLIGHT DRIVING CONDITIONS	5
6 ELECTRO-OPTICAL CHARACTERISTICS	6
7 BLOCK DIAGRAM	8
8 INTERFACE DESCRIPTION	9
8.1 TFT assignment.....	9
8.2 Touch panel assignment.....	9
8.3 CON1 assignment.....	9
9 TIMING CHARACTERISTICS	10
9.1 System bus timing for RGB interface.....	10
9.1.1 SYNC Mode	10
9.1.2 SYNC-DE Mode	11
9.1.3 DE Mode	12
9.2 Parallel 24-bit RGB input timing table.....	12
9.3 Power ON/OFF sequence	13
9.3.1 Power On sequence.....	13
9.3.2 Power Off sequence	13
10 CAPACITIVE TOUCH SCREEN PANEL SPECIFICATIONS	13
10.1 Mechanical characteristics	13
10.2 Electrical characteristics	14
11 INSPECTION	14
11.1 Inspection condition.....	14
11.2 Inspection standard.....	15
12 RELIABILITY TEST.....	17
13 LEGAL INFORMATION.....	18

1 MODULE CLASSIFICATION INFORMATION

RV	T	50	H	Q	T	N	W	C	00	B
1.	2.	3.	4.	5.	6.	7.	8.	9.	10.	11.

1.	BRAND	RV – Riverdi
2.	PRODUCT TYPE	T – TFT Standard
3.	DISPLAY SIZE	50 – 5.0”
4.	MODEL SERIAL NO.	H – High Brightness, IPS
5.	RESOLUTION	Q – 800 x 480 px
6.	INTERFACE	T– TFT LCD, RGB
7.	FRAME	N – No Frame
8.	BACKLIGHT TYPE	W – LED White
9.	TOUCH PANEL	C – With Capacitive Touch Panel
10.	VERSION	00 – (00-99)
11.	BONDING TECHNOLOGY	B – Optical Bonding

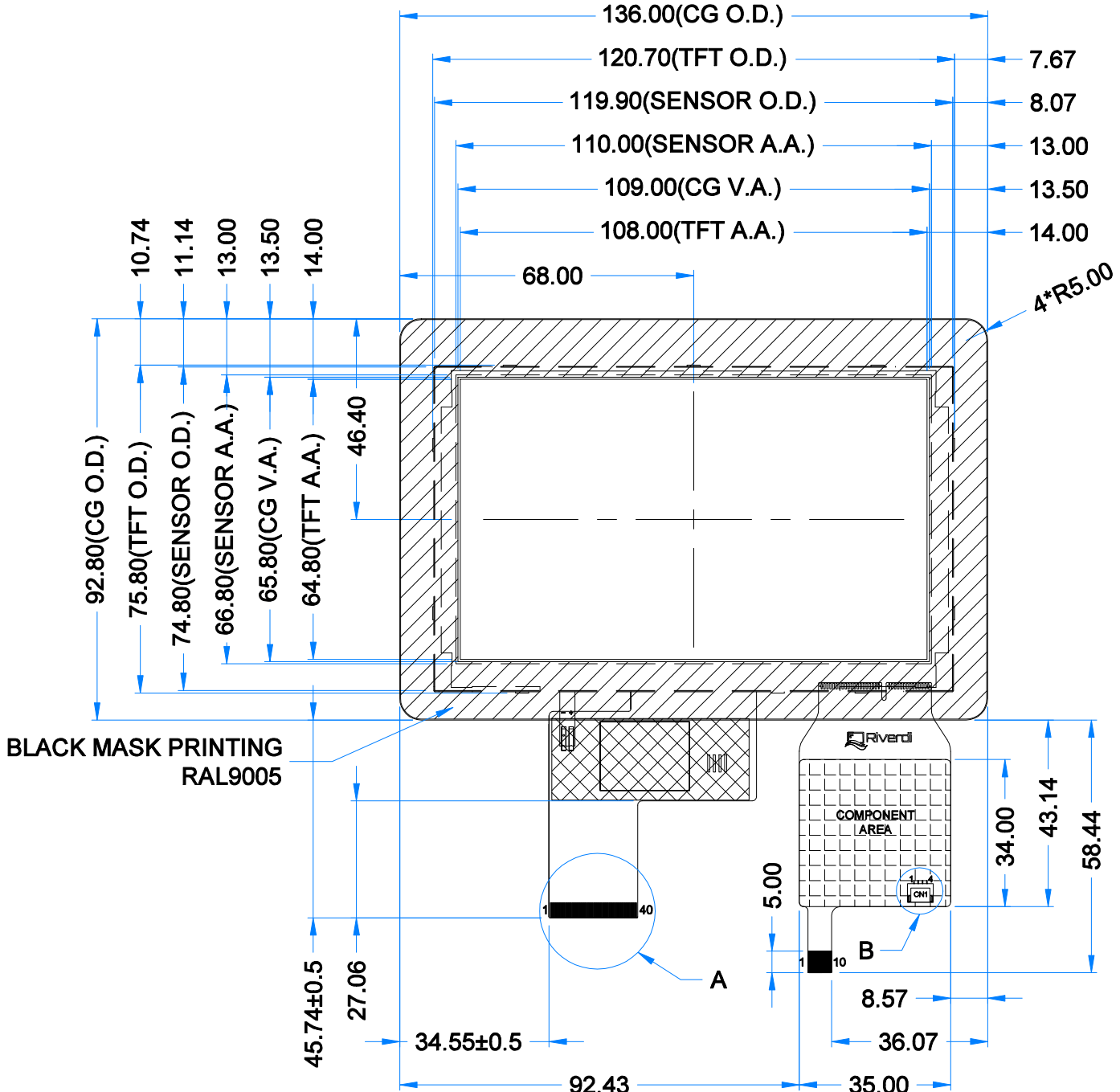

DETAIL A
SCALE 2:1

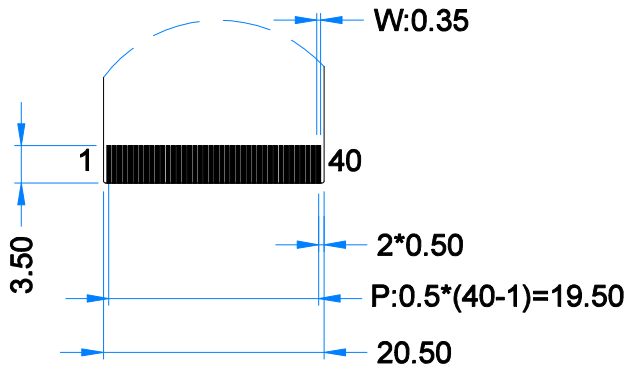

DETAIL B
SCALE 4:1

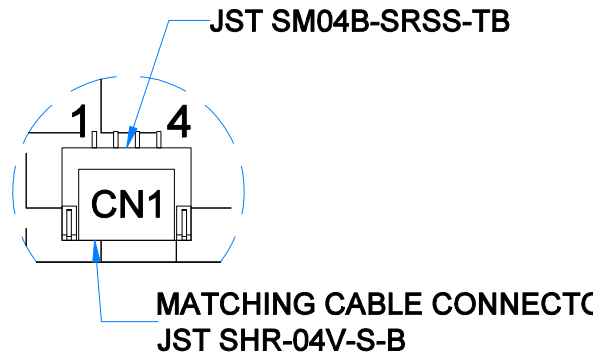

TFT NOTES:

1. LCD TYPE: TRANSMISSIVE, NORMALLY BLACK, IPS
2. RESOLUTION: 800x480
3. VIEWING ANGLE: FREE
4. IC CONTROLLER: ST7262-G4
5. OPERATING VOLTAGE: 3.3V
6. BACKLIGHT: 14-LED WHITE, Vf =12.0V, If =140mA

TP NOTES:

1. TP STRUCTURE: G+G
2. CG THICKNESS: 1.10 mm
3. DRIVER IC: ILI2132A
4. INTERFACE: USB; I2C; OPTIONAL UART
5. OPERATING VOLTAGE: 3.3V(I2C); 5.0V(USB)

GENERAL NOTES:

1. MODULE SURF
2. OPERATING T
3. STORAGE TE
4. WITHOUT IND
5. RoHS COMPL

3 ABSOLUTE MAXIMUM RATINGS

PARAMETER	SYMBOL	MIN	MAX	UNIT	NOTE
Operating Ambient temperature	T _{OP}	-20	70	°C	
Storage Temperature	T _{ST}	-30	80	°C	
Operating Ambient Humidity	H _{OP}	10	-	% RH	
Power for Circuit Driving	VDD	-0.3	5	V	
Backlight Forward Current	I _{LED}	-	25	mA	For Each LED

Note. The following are maximum values. If exceeded it may cause operation or damage to the unit.

4 ELECTRICAL CHARACTERISTICS

PARAMETER	SYMBOL	MIN	TYP	MAX	UNIT	
Power Supply for Analog Circuit	VDD	3.0	3.3	3.6	V	
Logic Input Voltage	Low Voltage	V _{IL}	0	-	0.3VDD	V
	High Voltage	V _{IH}	0.7VDD	-	VDD	V
Logic Output Voltage	Low Voltage	V _{OL}	-	-	GND+0.4	V
	High Voltage	V _{OH}	VDD - 0.4	-	-	V
Power Consumption	Black Mode	P _b	-	80	85	mA
	Standby Mode	P _w	-	40	50	uA

5 BACKLIGHT DRIVING CONDITIONS

PARAMETER	SYMBOL	MIN	TYP	MAX	UNIT	NOTE
Backlight Driving Voltage	V _F	11.2	12.0	12.8	V	Note 1,2
Backlight Driving Current	I _F	-	140	-	mA	
Backlight Power Consumption	W _{BL}	-	1680	-	mW	
Backlight Life Time	-	-	50,000	-	Hrs	Note 3

Note 1. Unless specified, the ambient temperature Ta=25°C

Note 2. The recommended operating conditions refer to a range in which operation of this product is guaranteed. Should this range is exceeded, the operation cannot be guaranteed even if the values may be without the absolute maximum ratings.

Note 3. If LED is driven by high current, high ambient temperature & humidity condition. The life time of LED will be reduced. Operating life means brightness goes down to 50% initial brightness. Typical operating life time is estimated data.

6 ELECTRO-OPTICAL CHARACTERISTICS

ITEM	SYMBOL	CONDITION	MIN	TYP	MAX	UNIT	REMARK	NOTE
Response Time	Tr+Tf	$\theta=0^\circ$ $\phi=0^\circ$ $T_a=25^\circ\text{C}$	-	30	-	ms	FIG 1.	4
Contrast Ratio	Cr		-	1000	-	---	FIG 2.	1
Luminance Uniformity	δ WHITE		-	75	-	%	FIG 2.	3
Surface Luminance	Lv		720	850	-	cd/m ²	FIG 2.	2
Viewing Angle Range	θ	$\phi = 90^\circ$	-	80	-	deg	FIG 3.	6
		$\phi = 270^\circ$	-	80	-	deg	FIG 3.	
		$\phi = 0^\circ$	-	80	-	deg	FIG 3.	
		$\phi = 180^\circ$	-	80	-	deg	FIG 3.	
CIE (x, y) Chromaticity	Red	x	0.575	0.615	0.655	FIG 2.	5	
		y	0.296	0.336	0.376			
	Green	x	0.352	0.392	0.432			
		y	0.512	0.552	0.592			
	Blue	x	0.100	0.140	0.180			
		y	0.085	0.125	0.165			
	White	x	0.274	0.316	0.358			
		y	0.295	0.336	0.378			

Note 1. Contrast Ratio(CR) is defined mathematically as below, for more information see Figure 1.

$$\text{Contrast Ratio} = \frac{\text{Average Surface Luminance with all white pixels (P1, P2, P3, P4, P5)}}{\text{Average Surface Luminance with all black pixels (P1, P2, P3, P4, P5)}}$$

Note 2. Surface luminance is the LCD surface from the surface with all pixels displaying white. For more information see Figure 2.

$$L_v = \text{Average Surface Luminance with all white pixels (P1, P2, P3, P4, P5)}$$

Note 3. The uniformity in surface luminance δ WHITE is determined by measuring luminance at each test position 1 through 5, and then dividing the maximum luminance of 5 points luminance by minimum luminance of 5 points luminance. For more information see Figure 2.

$$\delta \text{ WHITE} = \frac{\text{Minimum Surface Luminance with all white pixels (P1, P2, P3, P4, P5)}}{\text{Maximum Surface Luminance with all white pixels (P1, P2, P3, P4, P5)}}$$

Note 4. Response time is the time required for the display to transition from white to black (Rise Time, Tr) and from black to white (Decay Time, Tf). For additional information see Figure 1. The test equipment is Autronic-Melchers's ConoScope series.

Note 5. CIE (x, y) chromaticity, the x, y value is determined by measuring luminance at each test position 1 through 5, and then make average value.

Note 6. Viewing angle is the angle at which the contrast ratio is greater than 2. For TFT module the contrast ratio is greater than 10. The angles are determined for the horizontal or x axis and the vertical or y axis with respect to the z axis which is normal to LCD surface. For more information see Figure 3.

Note 7. For viewing angle and response time testing, the testing data is based on Autronic-Melchers’s ConoScope series. Instruments for Contrast Ratio, Surface Luminance, Luminance Uniformity, CIE the test data is based on TOPCON’s BM-5 photo detector.

Figure 1. The definition of response time

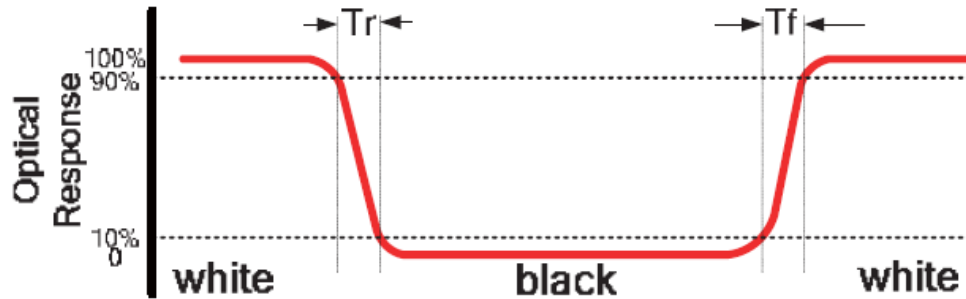

Figure 2. Measuring method for Contrast ratio, surface luminance, Luminance uniformity, CIE (x, y) chromaticity

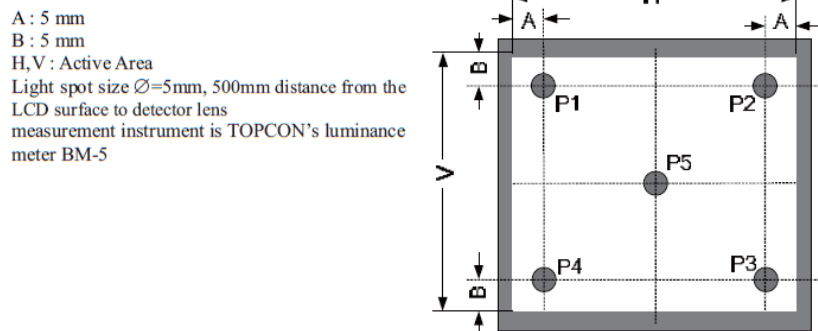
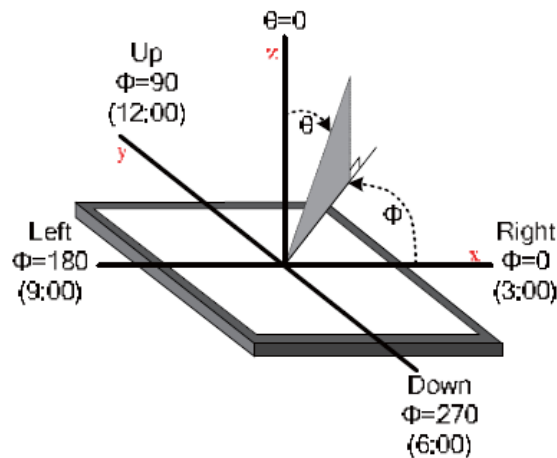
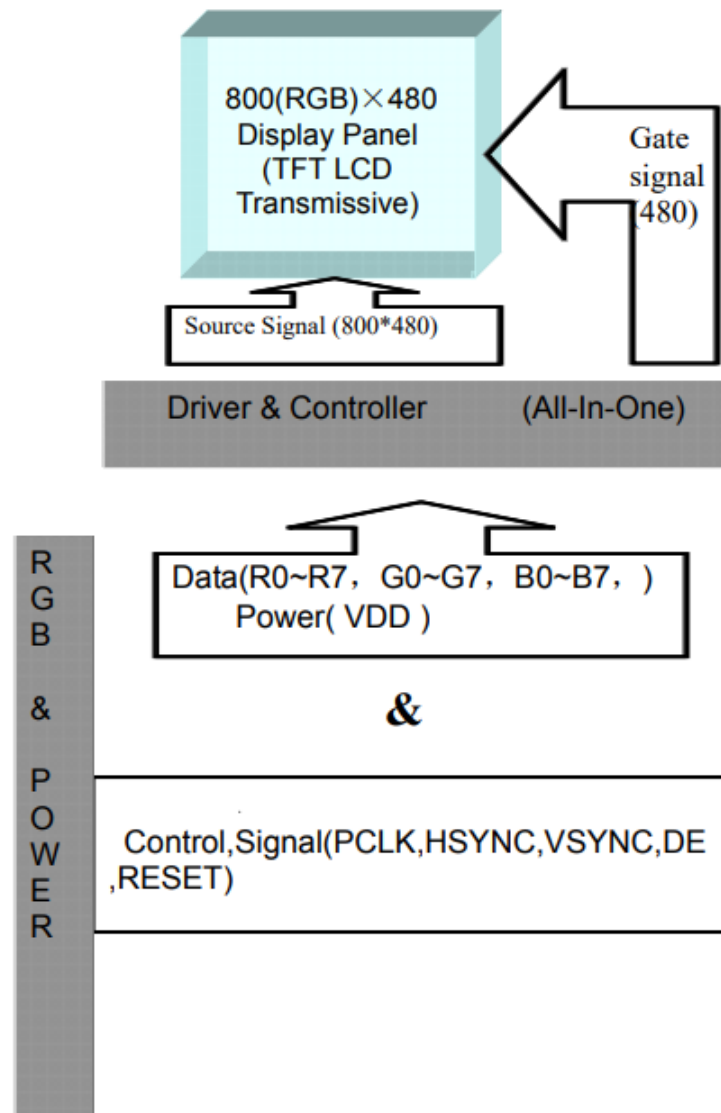

Figure 3. The definition of viewing angle



7 BLOCK DIAGRAM



8 INTERFACE DESCRIPTION

8.1 TFT assignment

PIN NO.	SYMBOL	DESCRIPTION
1	VLED-	Backlight Power Input PIN Cathode
2	VLED+	Backlight Power Input PIN Anode
3	GND	Ground
4	VDD	Power Supply Voltage
5-12	R0-R7	Red Data
13-20	G0-G7	Green Data
21-28	B0-B7	Blue Data
29	GND	Ground
30	DCLK	Clock for Input Data
31	DISP	Display on/off Control
32	HSYNC	Horizontal Synchronized Signal
33	VSNC	Vertical Synchronized Signal
34	DE	Data Input Enable
35	NC	Not Connect
36	GND	Ground
37	NC/XR	No Connect
38	NC/YD	No Connect
39	NC/XL	No Connect
40	NC/YU	No Connect

8.2 Touch panel assignment

PIN NO.	SYMBOL	DESCRIPTION
1	USB_GND	USB_Ground
2	USB_VDD	USB_Power for CTP, DC 5.0 V
3	USB_D-	USB_Data Signal -
4	USB_D+	USB_Data Signal +
5	I2C_GND	I2C_Ground
6	I2C_VDD	I2C_Power For CTP, DC 3.3 V
7	I2C_RST	I2C_Reset Pin
8	I2C_SCL	I2C_Clock Input
9	I2C_INT	I2C_Interrupt Signal from CTP
10	I2C_SDA/TXD	I2C_Data Signal

8.3 CON1 assignment

PIN NO.	SYMBOL	DESCRIPTION
1	USB_VDD	USB_Power for CTP, DC 5.0V
2	USB_D-	USB_Data Signal -
3	USB_D+	USB_Data Signal +
4	USB_GND	USB_Ground

9 TIMING CHARACTERISTICS

9.1 System bus timing for RGB interface

9.1.1 SYNC Mode

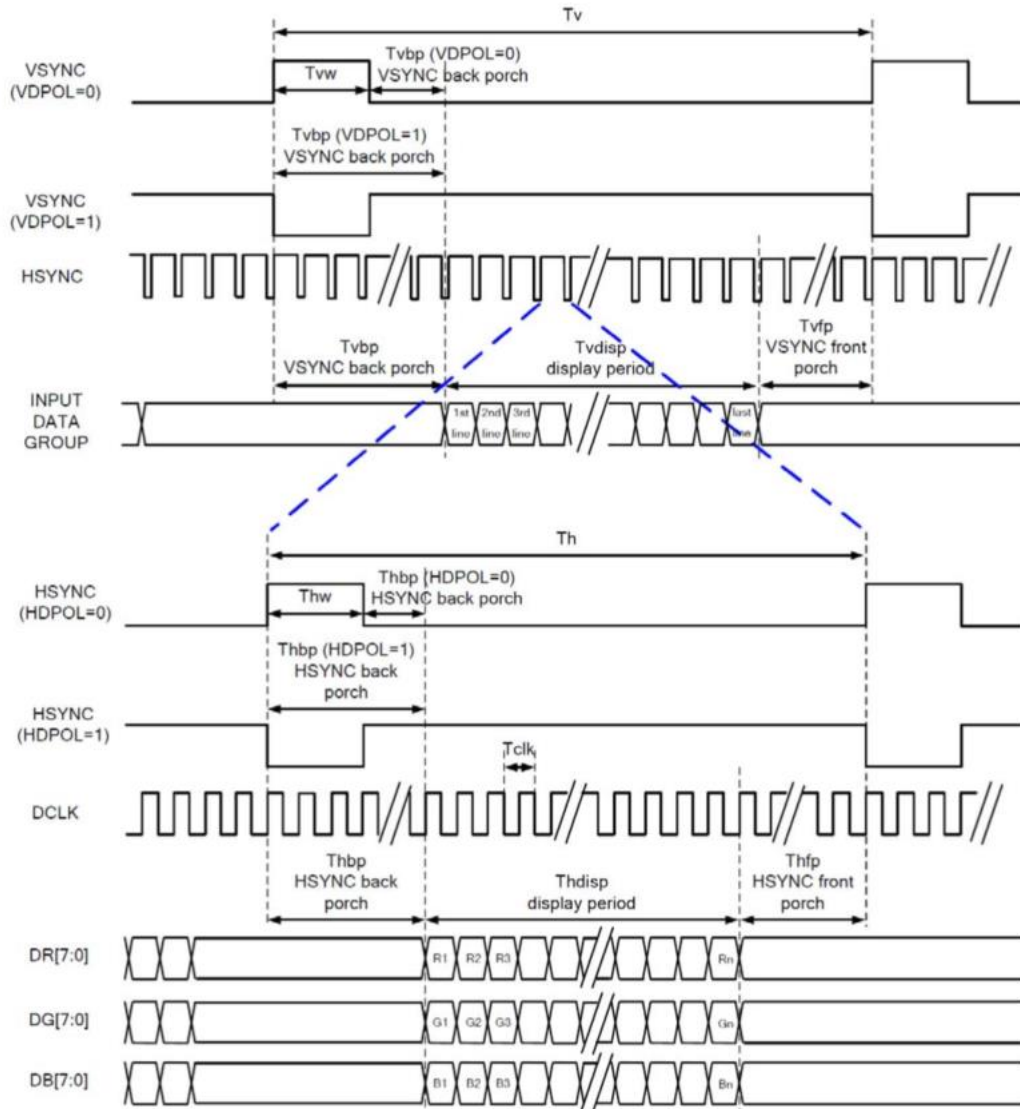

9.1.2 SYNC-DE Mode

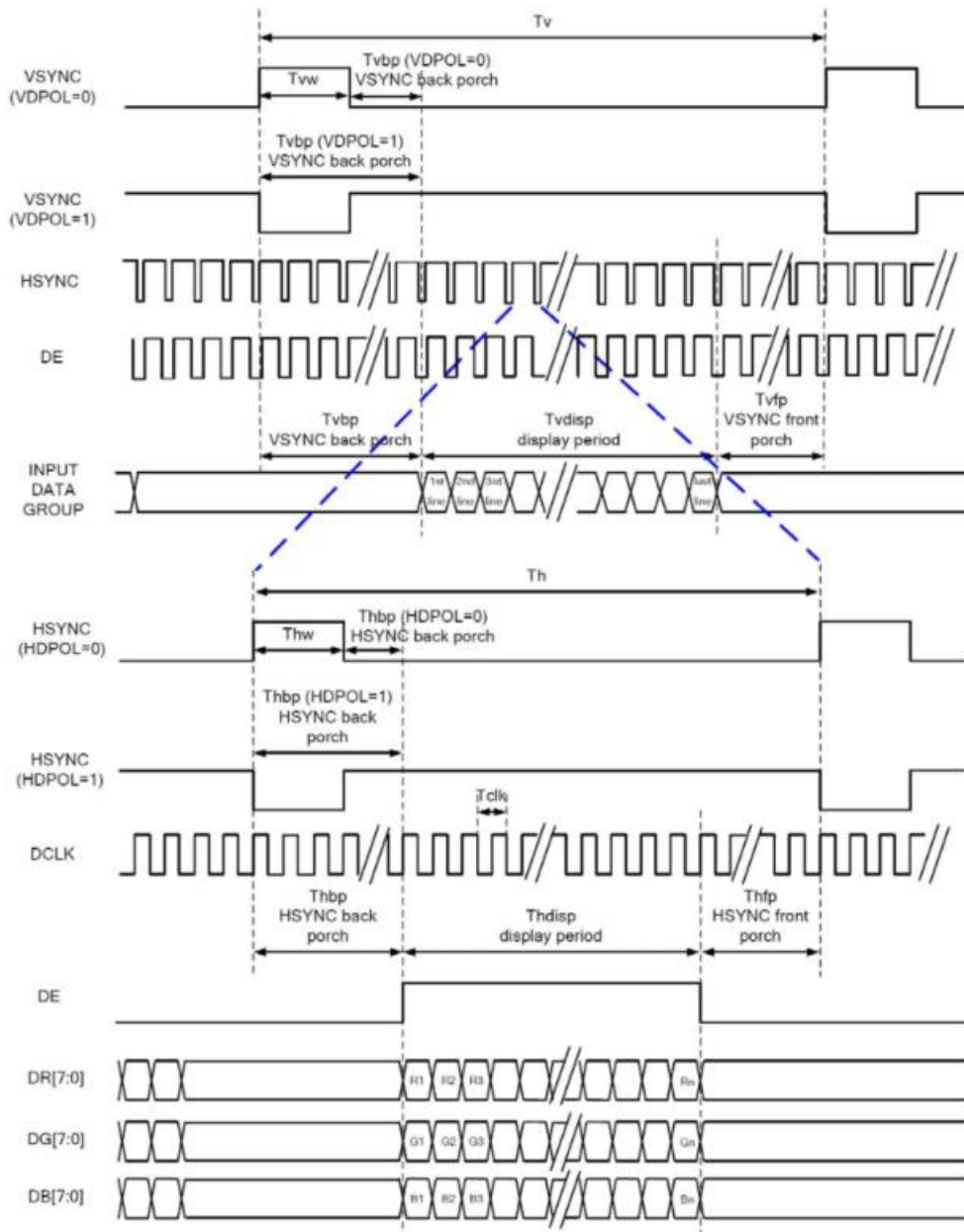

9.1.3 DE Mode

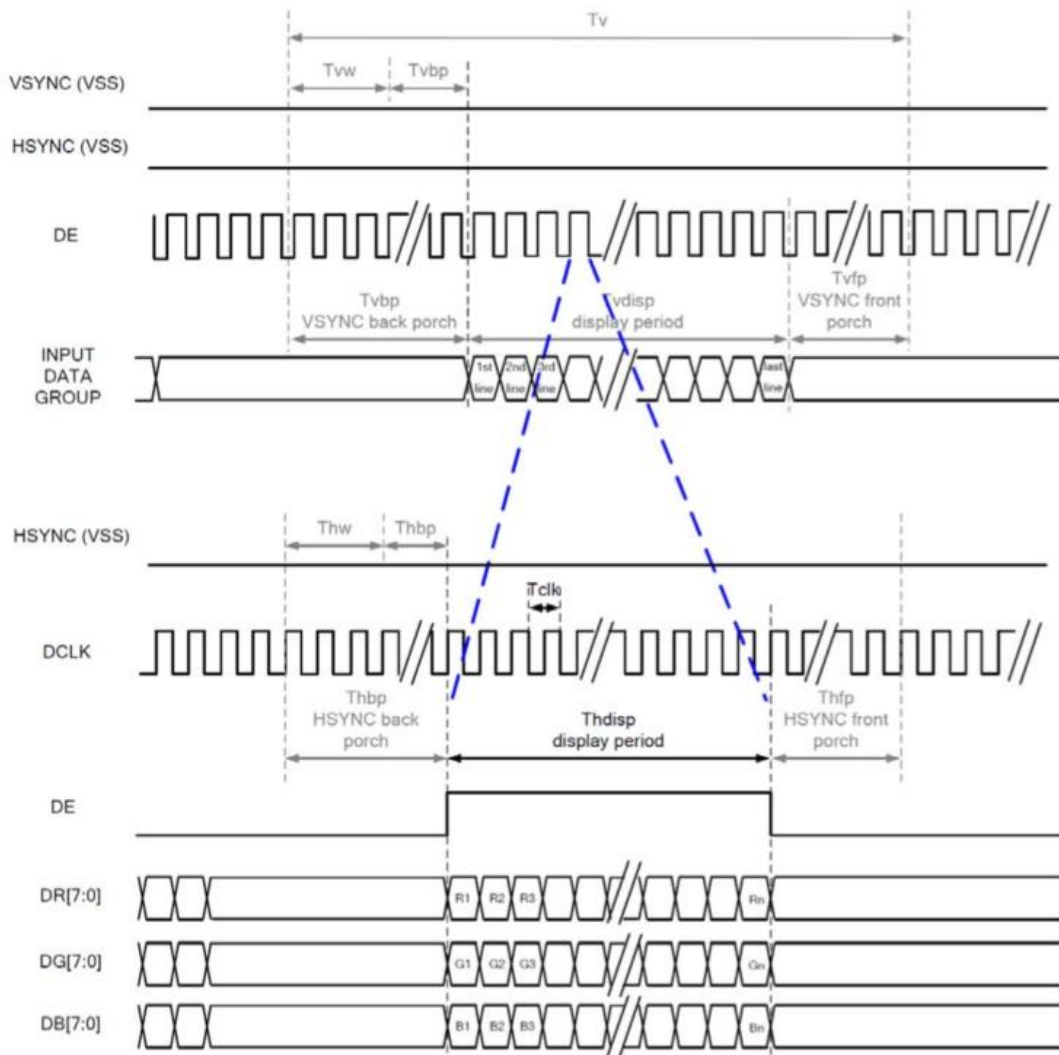

9.2 Parallel 24-bit RGB input timing table

Parallel 24-bit RGB input Timing (PVDD=VDD=VDDI=3.3V,AGND=0V,Ta=25 °C)

PARAMETER		SYMBOL	MIN	TYP	MAX	UNIT
DCLK Frequency		Fclk	23	25	27	MHz
HSYNC	Period Time	Th	808	816	896	DCLK
	Display Period	Thdisp		800		DCLK
	H _{sync} Back Porch	Thbp	4	8	48	DCLK
	H _{sync} Front Porch	Thfp	4	8	48	DCLK
	H _{sync} Pluse Width	Thw	2	4	8	DCLK
VSYNC	Period Time	Tv	488	496	504	HSYNC
	Display Period	Tvdisp		480		HSYNC
	V _{sync} Back Porch	Tvbp	4	8	12	HSYNC
	V _{sync} Front Porch	Tvfp	4	8	12	HSYNC
	V _{sync} Pluse Width	Tvw	2	4	8	HSYNC

9.3 Power ON/OFF sequence

9.3.1 Power On sequence

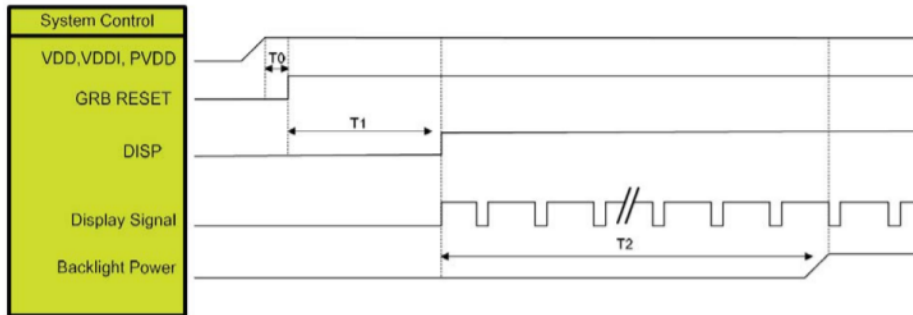

SYMBOL	DESCRIPTION	MIN. TIME	UNIT
T0	System power stability to GRB RESET signal	0	ms
T1	GRB RESET="High " to DISP="High "	10	ms
T2	Display Signal output to Backlight Power on	250	ms

Note. RGB interface display signal: DCLK, VSYNC, HSYNC, DE, DR[7:0], DB[7:0].

9.3.2 Power Off sequence

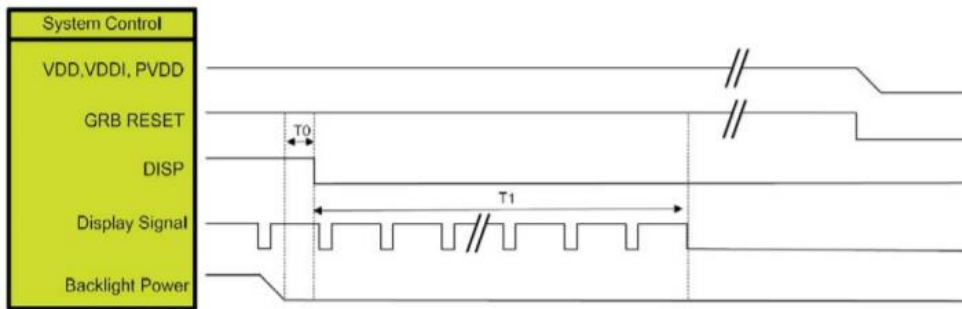

SYMBOL	DESCRIPTION	MIN. TIME	UNIT
T0	Backlight Power off to DISP="Low "	5	ms
T1	DISP = "Low " to IC internal voltage discharge complete	100	ms

Note. RGB interface display signal: DCLK, VSYNC, HSYNC, DE, DR[7:0], DB[7:0]

10 CAPACITIVE TOUCH SCREEN PANEL SPECIFICATIONS

10.1 Mechanical characteristics

DESCRIPTION	SPECIFICATION	REMARK
Touch Panel Size	5.0 inch	UxTouch
Outline Dimension of CTP	136.00 mm x 92.80 mm	UxTouch
Product Thickness	2.45 mm	UxTouch
Glass Thickness	1.1 mm	UxTouch
CTP View Area	109.00 mm x 65.80 mm	UxTouch
Sensor Active Area	110.00 mm x 66.80 mm	UxTouch
Structure type	Glass + Glass	UxTouch
Surface Hardness	6H	UxTouch

10.2 Electrical characteristics

DESCRIPTION		SPECIFICATION
Operating Voltage		DC 5.0 V (USB)
		DC 3.3 V (I ² C)
Power Consumption (IDD)	Active Mode	90 mA
	Sleep Mode	10 mA
Interface		USB / I ² C/Optional UART
Linearity		+/-1.5mm
Controller		ILI2132A
I2C address		0X82
Resolution		800 x 480

11 INSPECTION

Standard acceptance/rejection criteria for TFT module.

11.1 Inspection condition

Ambient conditions:

- Temperature: 25±2°C
- Humidity: (60±10)%RH
- Illumination: Single fluorescent lamp non-directive (300 to 700 lux)

Viewing distance:

35±5cm between inspector bare eye and LCD.

Viewing Angle:

U/D: 45°/45°, L/R 45°/45°

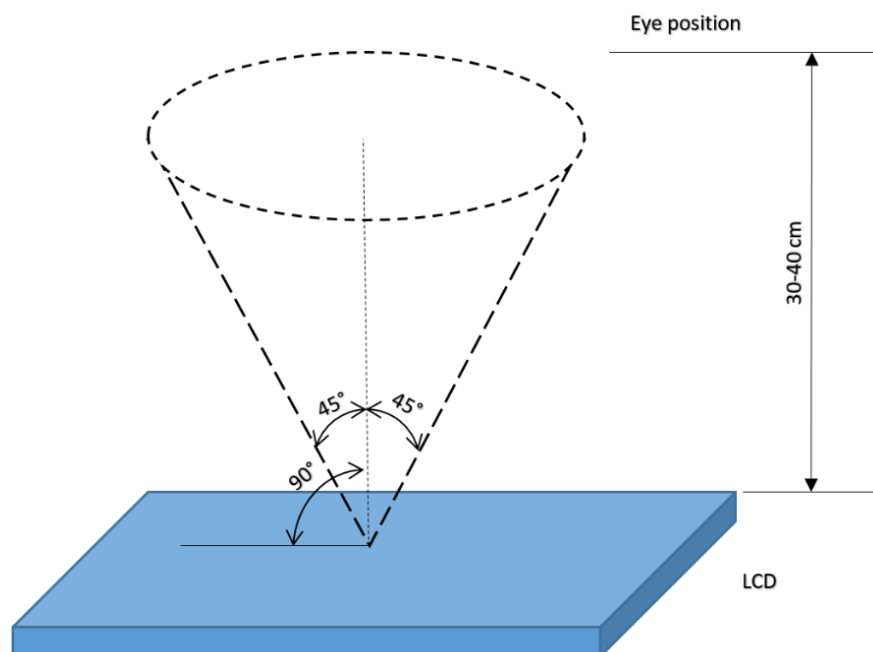

11.2 Inspection standard

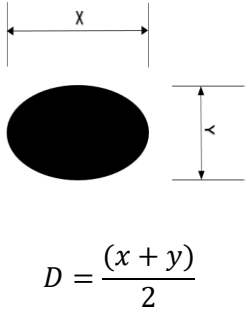
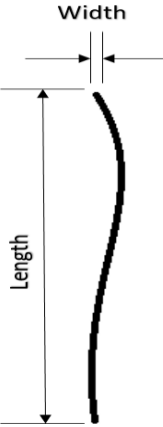
Item	Criterion																																	
Black spots, white spots, light leakage, Foreign Particle (round Type)	 <p style="text-align: center;">$D = \frac{(x + y)}{2}$</p> <p>*Spots density: 10 mm</p> <table border="1" style="width: 100%; border-collapse: collapse;"> <thead> <tr> <th colspan="2" style="background-color: #cccccc;">3.5" ≤ Size ≤ 5"</th> </tr> <tr> <th style="width: 50%;">Average Diameter</th> <th style="width: 50%;">Qualified Qty</th> </tr> </thead> <tbody> <tr> <td>D ≤ 0.15 mm</td> <td>Ignored</td> </tr> <tr> <td>0.15 mm < D ≤ 0.30 mm</td> <td>N≤3</td> </tr> <tr> <td>0.3mm < D</td> <td>Not allowed</td> </tr> </tbody> </table> <table border="1" style="width: 100%; border-collapse: collapse;"> <thead> <tr> <th colspan="2" style="background-color: #cccccc;">Size =7"</th> </tr> <tr> <th style="width: 50%;">Average Diameter</th> <th style="width: 50%;">Qualified Qty</th> </tr> </thead> <tbody> <tr> <td>D ≤ 0.2 mm</td> <td>Ignored</td> </tr> <tr> <td>0.2 mm < D ≤ 0.3 mm</td> <td>N≤3</td> </tr> <tr> <td>0.5mm < D</td> <td>Not allowed</td> </tr> </tbody> </table>	3.5" ≤ Size ≤ 5"		Average Diameter	Qualified Qty	D ≤ 0.15 mm	Ignored	0.15 mm < D ≤ 0.30 mm	N≤3	0.3mm < D	Not allowed	Size =7"		Average Diameter	Qualified Qty	D ≤ 0.2 mm	Ignored	0.2 mm < D ≤ 0.3 mm	N≤3	0.5mm < D	Not allowed													
3.5" ≤ Size ≤ 5"																																		
Average Diameter	Qualified Qty																																	
D ≤ 0.15 mm	Ignored																																	
0.15 mm < D ≤ 0.30 mm	N≤3																																	
0.3mm < D	Not allowed																																	
Size =7"																																		
Average Diameter	Qualified Qty																																	
D ≤ 0.2 mm	Ignored																																	
0.2 mm < D ≤ 0.3 mm	N≤3																																	
0.5mm < D	Not allowed																																	
LCD black spots, white spots, light leakage (line Type)	 <p>*Spots density: 10 mm</p> <table border="1" style="width: 100%; border-collapse: collapse;"> <thead> <tr> <th colspan="3" style="background-color: #cccccc;">3.5" ≤ Size ≤ 5"</th> </tr> <tr> <th style="width: 33%;">Length/mm</th> <th style="width: 33%;">Width/mm</th> <th style="width: 33%;">Qualified Qty</th> </tr> </thead> <tbody> <tr> <td>-</td> <td>W ≤ 0.03</td> <td>Ignored</td> </tr> <tr> <td>L ≤ 3.0</td> <td>0.03 < W ≤ 0.05</td> <td>2</td> </tr> <tr> <td>L ≤ 3.0</td> <td>0.05 < W ≤ 0.1</td> <td>1</td> </tr> <tr> <td>3.0 < L</td> <td>0.1 < W</td> <td>Not allowed</td> </tr> </tbody> </table> <table border="1" style="width: 100%; border-collapse: collapse;"> <thead> <tr> <th colspan="3" style="background-color: #cccccc;">Size =7"</th> </tr> <tr> <th style="width: 33%;">Length</th> <th style="width: 33%;">Width</th> <th style="width: 33%;">Qualified Qty</th> </tr> </thead> <tbody> <tr> <td>-</td> <td>W ≤ 0.05</td> <td>Ignored</td> </tr> <tr> <td>L ≤ 5.0</td> <td>0.05 < W ≤ 0.1</td> <td>3</td> </tr> <tr> <td>5.0 < L</td> <td>0.10 < W</td> <td>Not allowed</td> </tr> </tbody> </table>	3.5" ≤ Size ≤ 5"			Length/mm	Width/mm	Qualified Qty	-	W ≤ 0.03	Ignored	L ≤ 3.0	0.03 < W ≤ 0.05	2	L ≤ 3.0	0.05 < W ≤ 0.1	1	3.0 < L	0.1 < W	Not allowed	Size =7"			Length	Width	Qualified Qty	-	W ≤ 0.05	Ignored	L ≤ 5.0	0.05 < W ≤ 0.1	3	5.0 < L	0.10 < W	Not allowed
3.5" ≤ Size ≤ 5"																																		
Length/mm	Width/mm	Qualified Qty																																
-	W ≤ 0.03	Ignored																																
L ≤ 3.0	0.03 < W ≤ 0.05	2																																
L ≤ 3.0	0.05 < W ≤ 0.1	1																																
3.0 < L	0.1 < W	Not allowed																																
Size =7"																																		
Length	Width	Qualified Qty																																
-	W ≤ 0.05	Ignored																																
L ≤ 5.0	0.05 < W ≤ 0.1	3																																
5.0 < L	0.10 < W	Not allowed																																
Bright/Dark Dots	<table border="1" style="width: 100%; border-collapse: collapse;"> <thead> <tr> <th colspan="2" style="background-color: #cccccc;">3.5" ≤ Size ≤ 5"</th> </tr> <tr> <th style="width: 70%;">item</th> <th style="width: 30%;">Qualified Qty</th> </tr> </thead> <tbody> <tr> <td>Bright Dots</td> <td>N≤1</td> </tr> <tr> <td>Dark Dots</td> <td>N≤2</td> </tr> <tr> <td>Total Bright and Dark Dots</td> <td>N≤3</td> </tr> </tbody> </table> <table border="1" style="width: 100%; border-collapse: collapse;"> <thead> <tr> <th colspan="2" style="background-color: #cccccc;">Size =7"</th> </tr> <tr> <th style="width: 70%;">item</th> <th style="width: 30%;">Qualified Qty</th> </tr> </thead> <tbody> <tr> <td>Bright Dots</td> <td>N≤2</td> </tr> <tr> <td>Dark Dots</td> <td>N≤3</td> </tr> <tr> <td>Total Bright and Dark Dots</td> <td>N≤4</td> </tr> </tbody> </table>	3.5" ≤ Size ≤ 5"		item	Qualified Qty	Bright Dots	N≤1	Dark Dots	N≤2	Total Bright and Dark Dots	N≤3	Size =7"		item	Qualified Qty	Bright Dots	N≤2	Dark Dots	N≤3	Total Bright and Dark Dots	N≤4													
3.5" ≤ Size ≤ 5"																																		
item	Qualified Qty																																	
Bright Dots	N≤1																																	
Dark Dots	N≤2																																	
Total Bright and Dark Dots	N≤3																																	
Size =7"																																		
item	Qualified Qty																																	
Bright Dots	N≤2																																	
Dark Dots	N≤3																																	
Total Bright and Dark Dots	N≤4																																	

Item	Criterion		
Clear spots	Size < 5"		
	Average Diameter	Qualified Qty	
	D < 0.2 mm	Ignored	
	0.2 mm < D < 0.3 mm	3	
	0.3 mm < D < 0.5 mm	2	
	0.5 mm < D	0	
	Size >= 5"		
	Average Diameter	Qualified Qty	
	D<0.2 mm	Ignored	
	0.2 mm < D < 0.3 mm	4	
	0.3 mm < D < 0.5 mm	2	
	0.5 mm < D	0	
	*Spots density: 10 mm		
	Polarizer bubbles	3.5" ≤ Size ≤ 5"	
Average Diameter		Qualified Qty	
D ≤ 0.2 mm		Ignored	
0.2 mm < D ≤ 0.3 mm		2	
0.3 mm < D ≤ 0.5mm		1	
0.5 mm < D		0	
Total Q'ty		3	
Size >= 5"			
Average Diameter		Qualified Qty	
D<0.25 mm		Ignored	
0.25 mm < D < 0.5 mm		3	
0.5 mm < D		0	
Touch panel spot		Size < 5"	
		Average Diameter	Qualified Qty
	D < 0.2 mm	Ignored	
	0.2 mm < D < 0.4 mm	5	
	0.4 mm < D < 0.5 mm	2	
	0.5 mm < D	0	
Touch panel White line Scratch	Size < 5"		
	Length	Width	Qualified Qty
	-	W< 0.02	Ignored
	L < 3.0	0.02 < W <0.05	2
	L < 2.5	0.05 < W <0.08	
	-	0.08 < W	0

12 RELIABILITY TEST

NO.	TEST ITEM	TEST CONDITION
1	High Temperature Storage	80°C/120 hours
2	Low Temperature Storage	-30°C/120 hours
3	High Temperature Operating	70 °C /120 hours
4	Low Temperature Operating	-20°C/120 hours
5	High Temperature and High Humidity	Humidity 40°C, 90%RH, 120Hrs
6	Thermal Cycling Test (No operation)	-20°C for 30min, 70°C for 30 min. 100 cycles. Then test at room temperature after 1 hour
7	Damp Proof Test	40°C, 90%RH/120 hours
8	Vibration Test	Frequency :10~55 HZ; Stroke :1.5mm; Sweep:10HZ~55HZ~10HZ; 2 hours for each direction of X, Y, Z(6 hours for total)
9	Package Drop Test	Height: 60 cm 1 corner,3 edges,6 surfaces
10	ESD Test	Air: ±2 KV , Human Body Mode, 100 pF /1500 Ω

Note 1. Sample quantity for each test item is 5 ~ 10 pcs.

Note 2. Before cosmetic and function test, the product must have enough recovery time, at least 2 hours at room temperature.

13 LEGAL INFORMATION

Riverdi grants the guarantee for the proper operation of the goods for a period of 12 months from the date of possession of the goods. If as a consequence of performing the obligation resulting from this guarantee the customer received a good free of defect instead of the defective good, then the period for the effectiveness of the guarantee shall commence anew from the moment the customer receives the good free of defects. Information about device is the property of Riverdi and may be the subject of patents pending or granted. It is not allowed to copy or disclosed this document without prior written permission.

Riverdi endeavors to ensure that the all contained information in this document is correct but does not accept liability for any error or omission. Riverdi products are in developing process and published information may be not up to date. Riverdi reserves the right to update and makes changes to Specifications or written material without prior notice at any time. It is important to check the current position with Riverdi.

Images and graphics used in this document are only for illustrative the purpose. All images and graphics are possible to be displayed on the range products of Riverdi, however the quality may vary. Riverdi is no liable to the buyer or to any third party for any indirect, incidental, special, consequential, punitive or exemplary damages (including without limitation lost profits, lost savings, or loss of business opportunity) relating to any product, service provided or to be provided by Riverdi, or the use or inability to use the same, even if Riverdi has been advised of the possibility of such damages.

Riverdi products are not fault tolerant nor designed, manufactured or intended for use or resale as on line control equipment in hazardous environments requiring fail–safe performance, such as in the operation of nuclear facilities, aircraft navigation or communication systems, air traffic control, direct life support machines or weapons systems in which the failure of the product could lead directly to death, personal injury or severe physical or environmental damage ('High-Risk Activities'). Riverdi and its suppliers specifically disclaim any expressed or implied warranty of fitness for High-Risk Activities. Using Riverdi products and devices in 'High-Risk Activities' and in any other application is entirely at the buyer's risk, and the buyer agrees to defend, indemnify and hold harmless Riverdi from any and all damages, claims or expenses resulting from such use. No licenses are conveyed, implicitly or otherwise, under any Riverdi intellectual property rights.



X-ON Electronics

Largest Supplier of Electrical and Electronic Components

Click to view similar products for [TFT Displays & Accessories](#) category:

Click to view products by [Riverdi](#) manufacturer:

Other Similar products are found below :

[OAI-80038AA-2013-A](#) [LQ070Y3LG05](#) [HDA430T-3G1H](#) [TCG057VGLCA-G00](#) [EA CARREDIPTFT02](#) [NL6448BC20-21D](#)
[TM022HDHT11-00](#) [NB7W-KBA04](#) [NB-ATT01](#) [NB5Q-ATT01](#) [NB5Q-KBA04](#) [NB-CN001](#) [NL8060BC26-35C](#) [NL8060BC26-35F](#)
[TCG104SVLQAPNN-AN20](#) [OAI-80038AA-2008-A](#) [315-U004B15300](#) [UMSH-8596MD-34T \(REV D\)](#) [98-0003-3490-8](#) [1044278](#) [1029343](#)
[1060549](#) [DE 127-TU-30/7,5](#) [DE 128-TU-20/7,5](#) [EP-LK007TFTPCAP](#) [FR7.0A00](#) [RC2002A-TIG-CSX](#) [NL6448BC2021C](#)
[TX17D01VM2EAB](#) [TX14D23VM5BAA](#) [TCG121WXLRXVNNANX35](#) [EIC-LCD-1080P](#) [T272480C07VR01](#) [1060632](#)
[TCG070WVLPAANN-AN50](#) [TCG035QVLPDANN-GN50](#) [1060630](#) [RFK101VF-1YH-LHS](#) [NHD-1.8-128160EF-SSXN-FT](#)
[TCG104SVLPEANN-AN30](#) [EA uniTFTs020-ATC](#) [RVT43HLTFWN00](#) [RVT43HLTNWC00](#) [RVT43HLTNWC00-B](#) [RVT43HLTNWN00](#)
[RVT50HQTFWN00](#) [RVT50HQTNWC00](#) [RVT50HQTNWC00-B](#) [RVT50HQTNWN00](#) [RVT70HSLFWN00](#)