



RVT101HVHFWN00

IPS HDMI 10.1" LCD DATASHEET

Rev.1.0

2021-08-27

ITEM	CONTENTS	UNIT
LCD Type	TFT/Transmissive/Normally Black/IPS	/
Size	10.1	Inch
Viewing Direction	Free	/
Outside Dimensions (W x H x D)	246.66 x 151.30 x 18.56	mm
Active Area (W x H)	216.96 x 135.60	mm
Pixel Pitch (W x H)	0.1695 x 0.1695	mm
Resolution	1280 (RGB) x 800	/
Brightness	Max. 1000	cd/m ²
Color Depth	16.7 M	/
Pixel Arrangement	RGB Vertical Stripe	/
Controller of the Main Board	RTD2556T	/
Video Interface	HDMI	/
With/Without Touch	Without Capacitive Touch Panel	/
Power Supply	Power Jack (DC 8.0V - 14.0 V)	V
Weight	565	g

Note 1: RoHS3 compliant

Note 2: LCM weight tolerance: $\pm 5\%$.



1. REVISION RECORD

REV NO.	REV DATE	CONTENTS	REMARKS
1.0	2021-08-27	Initial Release	



2. CONTENTS

1.	REVISION RECORD.....	2
2.	CONTENTS.....	3
3.	MODULE CLASSIFICATION INFORMATION.....	4
4.	ASSEMBLY GUIDE.....	5
4.1	Mounting frame.....	5
5.	MODULE DRAWING.....	6
6.	ABSOLUTE MAXIMUM RATINGS.....	7
7.	ELECTRICAL CHARACTERISTICS.....	7
8.	BACKLIGHT DRIVING CONDITIONS.....	7
9.	ELECTRO-OPTICAL CHARACTERISTICS.....	8
10.	INTERFACE DESCRIPTION.....	10
10.1	PCB overview.....	10
10.2	Power connector - DC.....	11
10.3	HDMI connector – JP1.....	11
10.4	Touch panel connector - USB-C.....	11
10.5	External keyboard extension - J1.....	12
10.6	Backlight PWM & power - J5.....	12
10.7	UART connector - J2.....	12
11.	DISPLAY SPECIFICATION.....	12
11.1	TFT resolution.....	12
11.2	Full TFT specification.....	12
12.	INSPECTION.....	13
12.1	Inspection condition.....	13
12.2	Inspection standard.....	14
13.	RELIABILITY TEST.....	15
14.	LEGAL INFORMATION.....	16



3. MODULE CLASSIFICATION INFORMATION

RV	T	101	H	V	H	F	W	N	00
1.	2.	3.	4.	5.	6.	7.	8.	9.	10.

NO.	PARAMETER	SYMBOL
1.	BRAND	RV – Riverdi
2.	PRODUCT TYPE	T – TFT Standard
3.	DISPLAY SIZE	101 – 10.1"
4.	MODEL SERIAL NO.	H – High Brightness, IPS
5.	RESOLUTION	V – 1280 x 800 px
6.	INTERFACE	H – HDMI
7.	FRAME	F – With Mounting Metal Frame
8.	BACKLIGHT TYPE	W – LED White
9.	TOUCH PANEL	N – With Capacitive Touch Panel
10.	VERSION	00 – (00-99)

4. ASSEMBLY GUIDE

4.1 Mounting frame

For dimensions 3.5", 4.3", 5.0", 7.0" and 10.1", the product with mounting frame version is available. Thanks to the four catches attached to the side, frame provides strong assembly to the surface by mounting element (like the screw, see Figure 1). The frames are specially designed to fit Riverdi products perfectly. The diameter of the mounting hole is 3.5mm.

Figure 1. Mounting frame



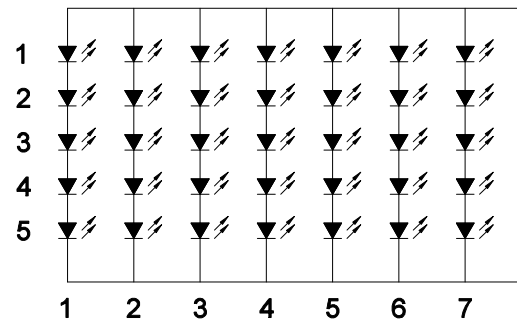
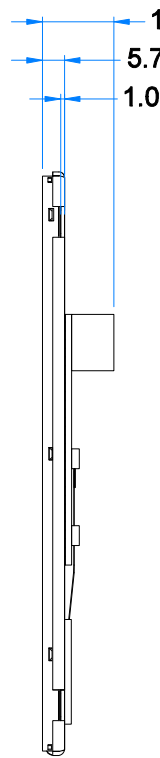
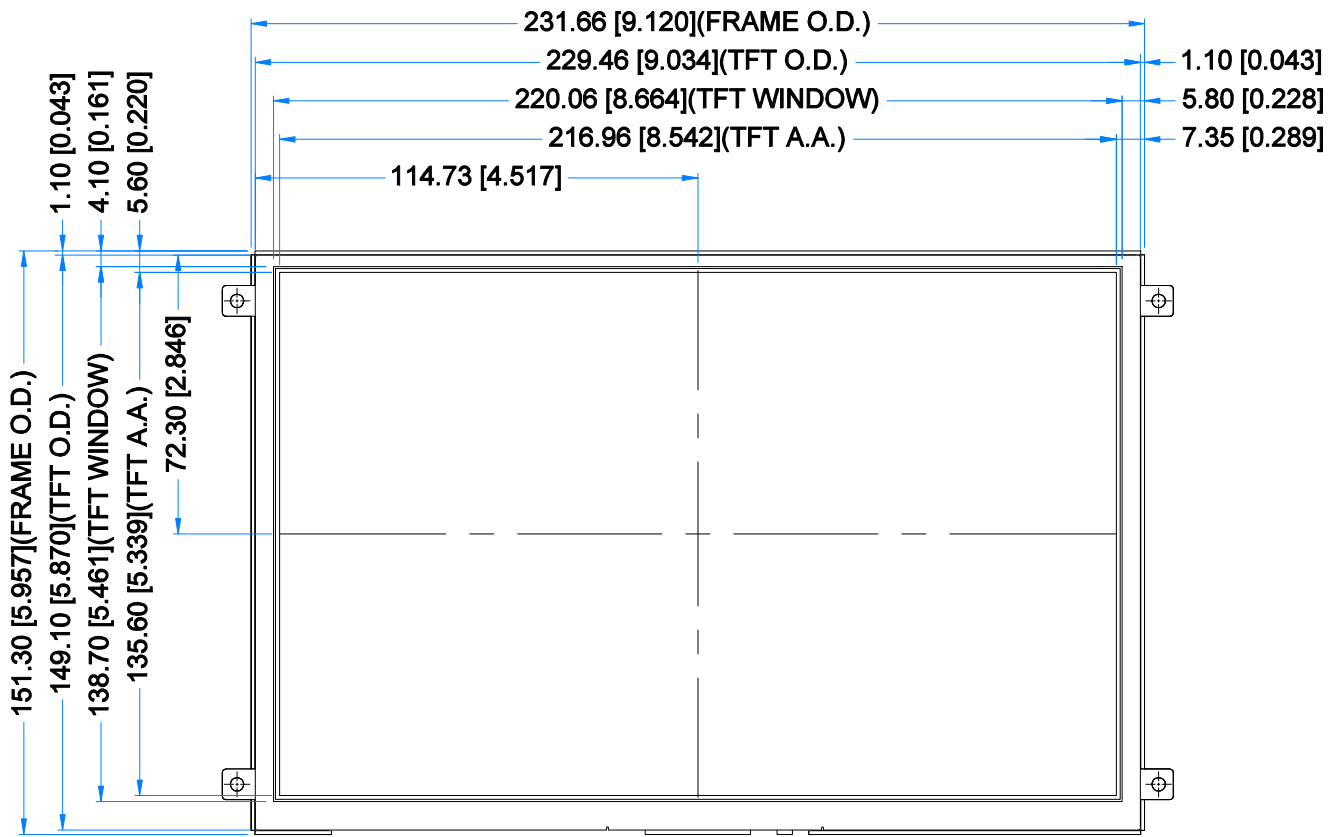

LED Diagram Circ

LCM NOTES:

1. LCD TYPE: TRANSMISSIVE, NORMALLY BLACK, IPS
2. RESOLUTION: 1280x800
3. VIEWING ANGLE: FREE
4. SURFACE LUMINANCE: 1000cd/m²
5. CONTROLLER IC OF MAIN BOARD: RTD2556T
6. VIDEO INTERFACE: HDMI
7. POWER SUPPLY: POWER JACK (7.0-14.0V)
8. ZERO BAD PIXEL

GENERAL NOTES:

1. OPERATING TEMPERATURE: -20°C ~ 70°C
2. STORAGE TEMPERATURE: -30°C ~ 80°C
3. WITHOUT INDIVIDUAL TOLERANCE:
±0.3mm[0.012inch]
4. RoH3 COMPLIANT



6. ABSOLUTE MAXIMUM RATINGS

PARAMETER	SYMBOL	MIN	MAX	UNIT
Supply Voltage for Module	VDD	8.0	14.0	V
Operating Temperature	T _{OP}	-20	70	°C
Storage Temperature	T _{ST}	-30	80	°C
Storage Humidity (@ 25 ± 5°C)	H _{ST}	10	-	% RH
Operating Ambient Humidity (@ 25 ± 5°C)	H _{OP}	10	-	% RH

Note. Exceeding maximum values may cause operation or damage to the unit.

7. ELECTRICAL CHARACTERISTICS

PARAMETER	SYMBOL	MIN	TYP	MAX	UNIT	NOTE
Supply Voltage for Module	VDD	8.0	12.0	14.0	V	
Current Drawn from VDD	I _{VDD=8.0V}	293	946	1600	mA	NOTE 1
Current Drawn from VDD	I _{VDD=12.0V}	189	569	950	mA	
Current Drawn from VDD	I _{VDD=14.0V}	194	495	796	mA	

Note 1. Mi. Current was measured with BL brightness set to 0%,
 Typ. current was measured with BL brightness set to 50%,
 Max. current was measured with BL brightness set to 100%.

8. BACKLIGHT DRIVING CONDITIONS

PARAMETER	SYMBOL	MIN	TYP	MAX	UNIT
Backlight Power Consumption	WBL	-	5760	-	mW
Lifetime	-	-	50,000	-	

Note. Operating life means the period in which the LED brightness goes down to 50% of the initial brightness. Typical operating lifetime is the estimated parameter.



9. ELECTRO-OPTICAL CHARACTERISTICS

Optical characteristics are determined after the unit has been ‘ON’ and stable for approximately 30 minutes in a dark environment at 25 °C. The values specified are at an approximate distance 500mm from the LCD surface at a viewing angle of Φ and θ equal to 0°.

ITEM	SYMBOL	CONDITION	MIN	TYP	MAX	UNIT	RMK	NOTE
Response Time	Tr+Tf	$\theta=0^\circ$ $\phi=0^\circ$ Ta=25 °C	-	25	35	ms	FIG 2.	4
Contrast Ratio	Cr		-	800	1000	---	FIG 3.	1
Luminance Uniformity	δ WHITE		-	75	-	%	FIG 3.	3
Surface Luminance	Lv		-	-	1000	cd/m2	FIG 3.	2
Viewing Angle Range	θ	$\phi = 90^\circ$	75	85	-	deg	FIG 4.	6
		$\phi = 270^\circ$	75	85	-	deg	FIG 4.	
		$\phi = 0^\circ$	75	85	-	deg	FIG 4.	
		$\phi = 180^\circ$	75	85	-	deg	FIG 4.	
CIE (x, y) Chromaticity	Rx	$\theta=0^\circ$ $\phi=0^\circ$ Ta=25 °C	0.22	0.26	0.30	-	FIG 3.	5
	Ry		0.20	0.24	0.28	-		
	Gx		0.34	0.38	0.42	-		
	Gy		0.50	0.54	0.58	-		
	Bx		0.10	0.14	0.18	-		
	By		0.09	0.13	0.17	-		
	Wx		0.28	0.32	0.36	-		
	Wy		0.29	0.33	0.37	-		

Note 1. Contrast Ratio (CR) is defined mathematically as below, for more information see Figure 3.

$$\text{Contrast Ratio} = \frac{\text{Average Surface Luminance with all white pixels (P1, P2, P3, P4, P5)}}{\text{Average Surface Luminance with all black pixels (P1, P2, P3, P4, P5)}}$$

Note 2. Surface luminance is the LCD surface from the surface with all pixels displaying white. For more information see Figure 3.

$$Lv = \text{Average Surface Luminance with all white pixels (P1, P2, P3, P4, P5)}$$

Note 3. The uniformity in surface luminance δ WHITE is determined by measuring luminance at each test position 1 through 5, and then dividing the minimum luminance of 5 points luminance by maximum luminance of 5 points luminance. For more information see Figure 3.

$$\delta \text{ WHITE} = \frac{\text{Minimum Surface Luminance with all white pixels (P1, P2, P3, P4, P5)}}{\text{Maximum Surface Luminance with all white pixels (P1, P2, P3, P4, P5)}}$$

Note 4. Response time is the time required for the display to transition from white to black (Rise Time, Tr) and from black to white (Decay Time, Tf). For additional information see Figure 2. The test equipment is Autronic-Melchers's ConoScope series.

Note 5. CIE (x, y) chromaticity, the x, y value is determined by measuring luminance at each test position 1 through 5, and then calculating the average value.

Note 6. Viewing angle is the angle at which the contrast ratio is greater than 2. For TFT module the contrast ratio is greater than 10. The angles are determined for the horizontal

or x axis and the vertical or y axis with respect to the z axis which is normal to LCD surface. For more information see Figure 4.

Note 7. For viewing angle and response time testing, the testing data is based on Autronic-Melchers's ConoScope series. Instruments for Contrast Ratio, Surface Luminance, Luminance Uniformity, CIE the test data is based on TOPCON's BM-5 photo detector.

Figure 2. The definition of response time

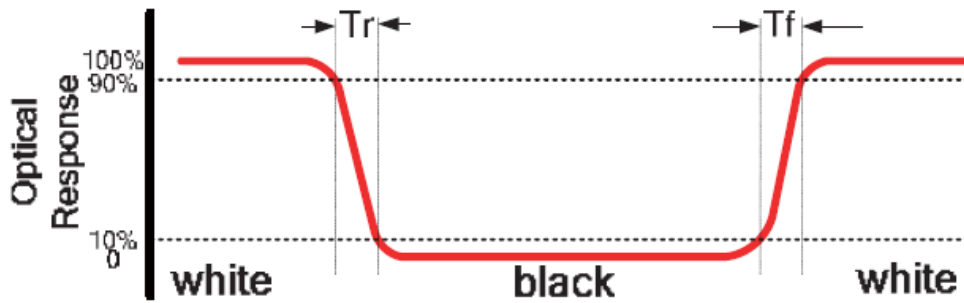
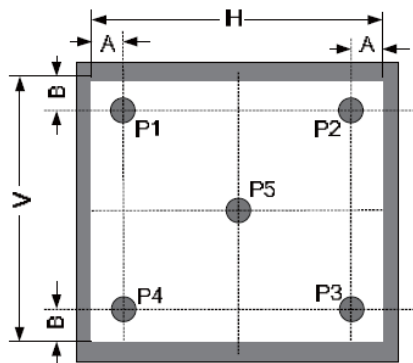

Figure 3. Measuring method for Contrast ratio, surface luminance, Luminance uniformity, CIE (x, y) chromaticity



A: 5mm

B: 5mm

H, V: Active Area

Light spot size $\varnothing=5\text{mm}$, 500mm distance from the LCD surface to detector lens.

Measurement instrument is TOPCON'S luminance meter BM-5

Figure 4. The definition of viewing angle

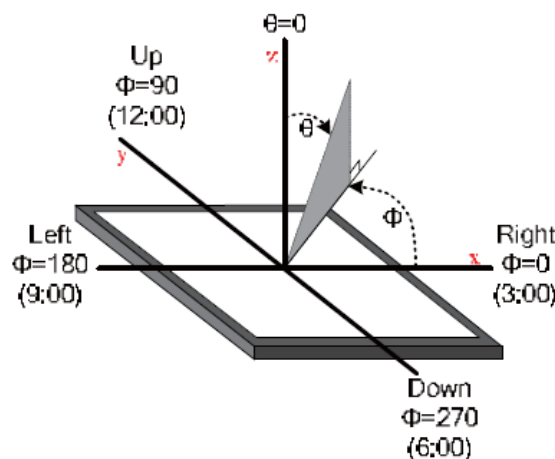

10. INTERFACE DESCRIPTION

10.1 PCB overview

Picture below shows the connectors exact placement and their descriptions.

The descriptions were extended for legibility reasons (table references)

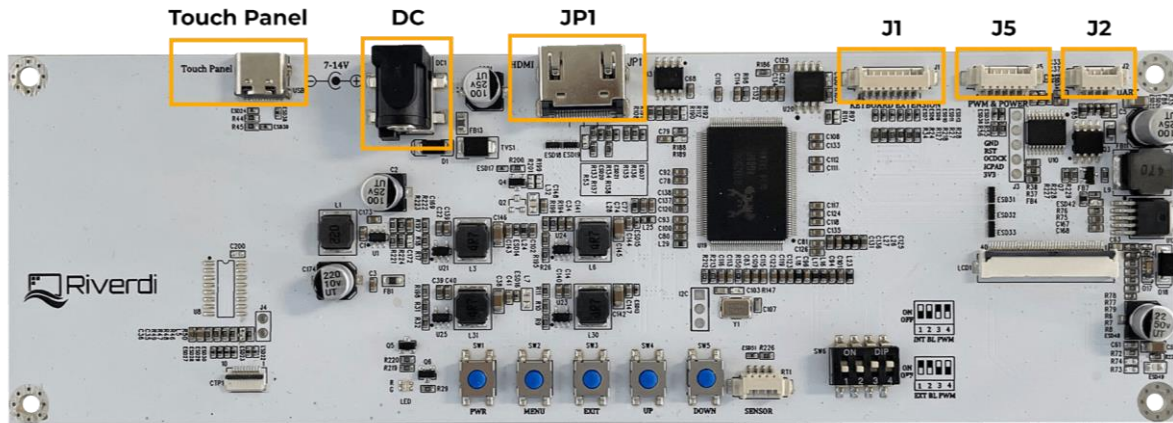

NAME	CONNECTOR	DESCRIPTION	NOTE
Touch Panel	USB-C	Touch panel interface This is only for versions with touch panel.	
DC	Power Jack	DC Jack, (5.5 mm OD; 2.1mm ID) This is the connector to power on the TFT module. It allows DC for voltage range from 7.0V to 14.0V	
JP2	HDMI connector	This is the connector to which you can connect the HDMI signal source to the module.	
J1	External keyboard connector	Molex 53261-0871; Horizontal, 1.25mm; 8 pins. The connector is reserved for external keyboard. Performs the same functions: PWR, MENU, EXIT, UP, DOWN as the push buttons on PCB.	Note 1
J5	Backlight PWM & Power	Molex 53261-0671; Horizontal, 1.25mm; 6 pins. The unit realizes the function of digital dimming. This connector enables to control backlight PWM externally.	Note 2
J2	UART	Molex 53261-0471; Horizontal, 1.25mm; 4 pins. It supports asynchronous serial communication UART port.	Note 3

Note 1. External keyboards are optional, not included in the standard completion.

Note 2. 4 position-DIP onboard switch SW6 is used to choose the power to backlight.

The settings are:

INTERNAL BL PWM: Set 1&2 to OFF, and 3&4 to ON,

EXTERNAL BL PWM: Set 1&2 to ON, and 3&4 to OFF.

Note 3. UART functionality is under development process and will be documented in next version of this datasheet.

Note 4. The feature of the light sensor is currently unavailable. If it's in demand, please contact us for confirmation.



10.2 Power connector - DC

PIN NO.	SYMBOL	DESCRIPTION
1	VDD	Power supply DC
2	GND	GND

10.3 HDMI connector – JPI

PIN NO.	SYMBOL	DESCRIPTION
1	TMDS Data 2+	TMDS differential signal 2+
2	TMDS Data2 Shield	Data2 shielding ground
3	TMDS Data 2-	TMDS differential signal 2-
4	TMDS Data 1+	TMDS differential signal 1+
5	TMDS Data1 Shield	Data1 shielding ground
6	TMDS Data 1-	TMDS differential signal 1-
7	TMDS Data 0+	TMDS differential signal 0+
8	TMDS Data 0 Shield	Data0 shielding ground
9	TMDS Data 0-	TMDS differential signal 0-
10	TMDS Data Clock+	TMDS differential signal Clock+
11	TMDS Data Shield	Clock shielding ground
12	TMDS Data Clock-	TMDS differential signal Clock-
13	CEC	Electronic protocol CEC
14	NC	No Connection
15	SCL	I ² C clock Line
16	SDA	I ² C data Line
17	DDC/CEC GND	Data display channel
18	+5V	HDMI 5V
19	Hot Plug Detect	Hot plug Detect

10.4 Touch panel connector - USB-C

PIN NO.	SYMBOL	DESCRIPTION
A1	USB_GND	USB_Ground
B12	USB_GND	USB_Ground
A4	V_BUS	V_Bus Power; 5V
B9	V_BUS	V_Bus Power; 5V
A5	CC1	Configuration channel
A6	DP1	USB differential pair, position 1, positive
A7	DN1	USB differential pair, position 1, negative
A8	SBU1	Sideband use
B5	CC2	Configuration channel
B6	DP2	USB differential pair, position 2, positive
B7	DN2	USB differential pair, position 2, negative
B8	SBU2	Configuration channel
A9	V_BUS	V_Bus Power; 5V
B4	V_BUS	V_Bus Power; 5V
A12	USB_GND	USB_Ground
B1	USB_GND	USB_Ground



Note 1. All the signals in Touch panel connector are in accordance with USB-C standard.

10.5 External keyboard extension - J1

PIN NO.	SYMBOL	DESCRIPTION
1	Down	Page down
2	Up	Page up
3	Exit	Exit
4	Menu	Menu
5	PWR	Power on/off
6	LED_EN	LED Enable. Active H, 3.3V
7	GND	Ground
8	Keyboard VDD	Keyboard VDD, max. 3.3 V

10.6 Backlight PWM & power - J5

PIN NO.	SYMBOL	DESCRIPTION
1	GND	Ground
2	GND	Ground
3	EN	Backlight enable, active H
4	PWM	PWM input (frequency - TBD)
5	VDD	Power supply (max. 10.6 V)
6	VDD	Power supply (max. 10.6 V)

Note. 4 position-DIP onboard switch **SW6** is used to choose the power source to backlight. The settings are:

- INTERNAL BL PWM: Set 1&2 to OFF, and 3&4 to ON,
- EXTERNAL BL PWM: Set 1&2 to ON, and 3&4 to OFF.

10.7 UART connector - J2

PIN NO.	SYMBOL	DESCRIPTION
1	GND	Ground
2	RXD	Receive Data
3	TXD	Transmit Data
4	VDD	VDD 3.3V

Note. UART functionality is under development process and will be documented in next version of this datasheet.

11. DISPLAY SPECIFICATION

11.1 TFT resolution

The supported resolution of the display in this module is 1280*800.

11.2 Full TFT specification

For detailed information on the display, please refer to datasheet of display RVT101HVLFWN00

12. INSPECTION

Standard acceptance/rejection criteria for TFT module

12.1 Inspection condition

Ambient conditions:

- Temperature: $25 \pm 2^{\circ}\text{C}$
- Humidity: $(60 \pm 10) \%RH$
- Illumination: Single fluorescent lamp non-directive (300 to 700 lux)

Viewing distance: $35 \pm 5\text{cm}$ between inspector bare eye and LCD.

Viewing Angle: U/D: $45^{\circ}/45^{\circ}$, L/R: $45^{\circ}/45^{\circ}$

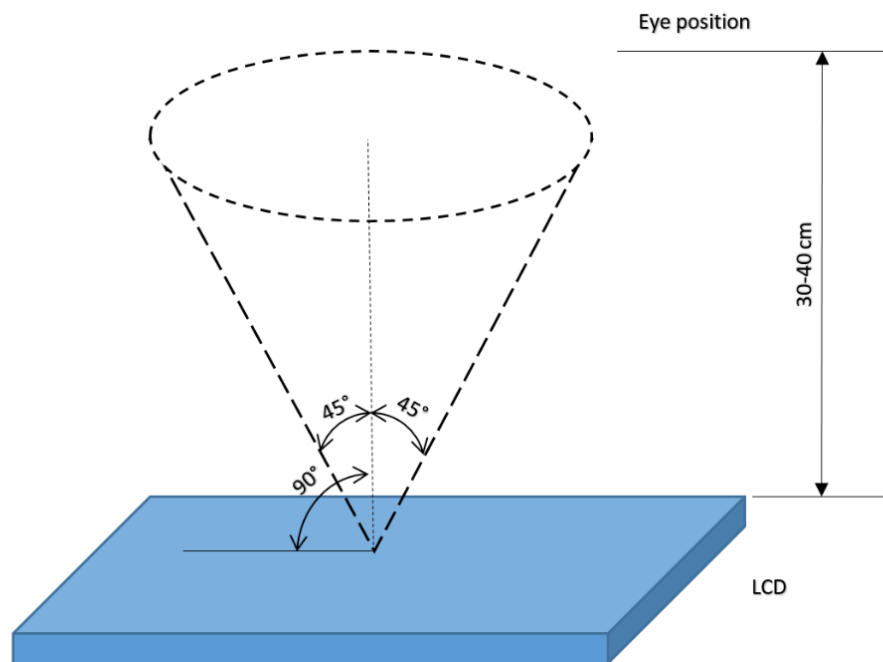



12.2 Inspection standard

The LCD TFT has zero bad pixels. Please refer the item “Bright/Dark dots”.

ITEM		CRITERION		
Black spots, white spots, light leakage, Foreign Particle (round Type)	<p>$D=(x+y)/2$ Spots density: 10 mm</p>	Size = 10.1"		
		Average Diameter	Qualified Qty	
		$D \leq 0.2$ mm	Ignored	
		$0.2 \text{ mm} < D \leq 0.3$ mm	N \leq 4	
		$0.5\text{mm} < D$	Not allowed	
LCD black spots, white spots, light leakage (line Type)	<p>Spots density: 10 mm</p>	Size = 10.1"		
		Length	Width	Qualified Qty
		-	$W \leq 0.05$	Ignored
		$L \leq 5.0$	$0.05 < W \leq 0.1$	N \leq 3
		$5.0 < L$	$0.10 < W$ $5.0 < L$	Not allowed
Bright/Dark Dots	Size = 10.1			
	Item	Qualified Qty		
	Bright dots	0		
	Dark dots	0		
	Cluster Bright Dots or Dark Dots	0		
Clear spots	Size \geq 5.0"			
	Average Diameter	Qualified Qty		
	$D < 0.2$ mm	Ignored		
	$0.2 \text{ mm} < D < 0.3$ mm	4		
	$0.3 \text{ mm} < D < 0.5$ mm	2		
	$0.5 \text{ mm} < D$	0		
Touch panel spots	Size \geq 5.0"			
	Average Diameter	Qualified Qty		
	$D < 0.25$ mm	Ignored		
	$0.25 \text{ mm} < D < 0.5$ mm	4		
Touch panel white line scratch	Size \geq 5.0"			
	Length	Width	Qualified Qty	
	-	$W < 0.03$	Ignored	
	$L < 5.0$	$0.03 < W < 0.05$	2	
	-	$0.05 < W$	0	



13. RELIABILITY TEST

NO.	TEST ITEM	TEST CONDITION	NOTE
1	High Temperature Storage	80°C/120 hours	Note 1
2	Low Temperature Storage	-30°C/120 hours	
3	High Temperature Operating	70 °C /120 hours	
4	Low Temperature Operating	-20°C/120 hours	
5	High Temperature and High Humidity	Humidity 40°C, 90%RH, 120Hrs	
6	Thermal Cycling Test (No operation)	-20°C for 30min, 70°C for 30 min. 100 cycles. Then test at room temperature after 1 hour	Note 2
7	Vibration Test	Frequency: 10 ÷ 55 Hz. Stroke: 1.5 mm. Sweep: 10Hz ÷ 55Hz ÷ 10 Hz. 2 hours for each direction of X, Y, Z (Total 6 hours)	
8	Package Drop Test	Height: 60 cm 1 corner, 3 edges, 6 surfaces	

Note 1. Sample quantity for each test item is 5 ÷ 10 pcs.

Note 2. Before cosmetic and function test, the product must have enough recovery time, at least 2 hours at room temperature.



14. LEGAL INFORMATION

Riverdi grants the guarantee for the proper operation of the goods for a period of 12 months from the date of possession of the goods. If in a consequence of this guaranteed execution the customer has received the defects-free item as replacement for the defective item, the effectiveness period of this guarantee shall start anew from the moment the customer receives the defects-free item.

Information about device is the property of Riverdi and may be the subject of patents pending or granted. It is not allowed to copy or disclosed this document without prior written permission.

Riverdi endeavors to ensure that all contained information in this document is correct but does not accept liability for any error or omission. Riverdi products are in developing process and published information may be not up to date. Riverdi reserves the right to update and makes changes to Specifications or written material without prior notice at any time. It is important to check the current position with Riverdi.

Images and graphics used in this document are only for illustrative the purpose. All images and graphics are possible to be displayed on the range products of Riverdi, however the quality may vary. Riverdi is no liable to the buyer or to any third party for any indirect, incidental, special, consequential, punitive, or exemplary damages (including without limitation lost profits, lost savings, or loss of business opportunity) relating to any product, service provided or to be provided by Riverdi, or the use or inability to use the same, even if Riverdi has been advised of the possibility of such damages.

Riverdi products are not fault tolerant nor designed, manufactured or intended for use or resale as on line control equipment in hazardous environments requiring fail-safe performance, such as in the operation of nuclear facilities, aircraft navigation or communication systems, air traffic control, direct life support machines or weapons systems in which the failure of the product could lead directly to death, personal injury or severe physical or environmental damage ('High-Risk Activities'). Riverdi and its suppliers specifically disclaim any expressed or implied warranty of fitness for High-Risk Activities. Using Riverdi products and devices in 'High-Risk Activities' and in any other application is entirely at the buyer's risk, and the buyer agrees to defend, indemnify, and hold harmless Riverdi from all damages, claims or expenses resulting from such use. No licenses are conveyed, implicitly or otherwise, under any Riverdi intellectual property rights.

Hi, I am here to help you!
If you have any additional
questions, please contact
our support via email:
contact@riverdi.com



X-ON Electronics

Largest Supplier of Electrical and Electronic Components

Click to view similar products for [TFT Displays & Accessories](#) category:

Click to view products by [Riverdi](#) manufacturer:

Other Similar products are found below :

[F3ET2-005-150](#) [HDA430T-3G1H](#) [NB7W-KBA04](#) [NB-ATT01](#) [NB5Q-ATT01](#) [NB5Q-KBA04](#) [NB-CN001](#) [OAI-80038AA-2008-A](#) [315-U004B15300](#) [TCG121WXLRXVNNANX35](#) [EIC-LCD-1080P](#) [T-55619GD065J-LW-ABN](#) [NLB150XG02L-01](#) [NL192108AC10-01D](#) [NL6448AC18-08F](#) [NL8060BC26-35BA](#) [NL6448BC26-26D](#) [NL8060BC31-50F](#) [TM070DDHG03-40](#) [PTPW16-070WV1S02](#) [PTPW16-084SV1S02](#) [MTD0300ECP06DF-1](#) [4DLCD-35480320-CTP-IPS](#) [4DLCD-35480320-IPS](#) [4DLCD-35480320-RTP-IPS](#) [4DLCD-50800480-CTP-IPS](#) [RFA6400E-AWH-DNG](#) [RFE430V-AZW-DNS](#) [RFF70BQ-1IW-DBG](#) [RFF70VA2-1IW-DHS](#) [RFH700A8-AYH-MNN](#) [RFK101VF-1YH-LHG](#) [RFS52VA-1ZH-DHN](#) [SM-RVT101HVHFWN00](#) [SM-RVT101HVHNWC00](#) [SM-RVT101HVHNWCA0](#) [SM-RVT101HVHNWN00](#) [SM-RVT101HVLFWCA0](#) [SM-RVT101HVLNWCA0](#) [SM-RVT35HHTFWCA0](#) [SM-RVT35HHTNWCA0](#) [SM-RVT43HLTFWCA0](#) [SM-RVT43HLTNWCA0](#) [SM-RVT50HQTFWCA0](#) [SM-RVT50HQTNWCA0](#) [SM-RVT70AQLFWR00](#) [SM-RVT70AQLNWR00](#) [SM-RVT70HSLFWCA0](#) [SM-RVT70HSMFWCA0](#) [SM-RVT70HSMFWN00](#)