



RVT35HHTNWC00

## IPS RGB 3.5" LCD TFT DATASHEET

Rev.1.1

2021-07-27

ITEM	CONTENTS	UNIT
LCD Type	TFT/Transmissive/Normally Black/IPS	/
Size	3.5	Inch
Viewing Direction	Free	/
Outside Dimensions (W x H x D)	93.96 x 76.44 x 5.41	mm
Active Area (W x H)	70.08 x 52.56	mm
Pixel Pitch (W x H)	0.219 x 0.219	mm
Resolution	320 x 240 (RGB)	/
Brightness	800	cd/m <sup>2</sup>
Color Depth	16.7 M	/
Pixel Arrangement	RGB Vertical Stripe	/
Driver IC of Board	ST7272A	/
Interface	RGB	/
With/Without Touch	With Projected Capacitive Touch Panel	/
CTP Driver	ILI2132A	/
Touch Interface	USB/I2C/Optional UART	/
Weight	60	g

**Note 1:** RoHS3 compliant

**Note 2:** LCM weight tolerance:  $\pm 5\%$ .



## 1. REVISION RECORD

REV NO.	REV DATE	CONTENTS	REMARKS
1.0	202-08-18	Initial Release	
1.1	2021-07-27	Updating new template	



## 2. CONTENTS

1.	REVISION RECORD.....	2
2.	CONTENTS.....	3
3.	MODULE CLASSIFICATION INFORMATION.....	4
4.	uxTouch ASSEMBLY .....	5
5.	MODULE DRAWING.....	6
6.	ABSOLUTE MAXIMUM RATINGS.....	7
7.	ELECTRICAL CHARACTERISTICS.....	7
8.	BACKLIGHT ELECTRICAL CHARACTERISTICS.....	7
9.	ELECTRO-OPTICAL CHARACTERISTICS.....	8
10.	BLOCK DIAGRAM .....	10
11.	INTERFACE DESCRIPTION.....	10
11.1	Touch panel assignment.....	11
11.2	CON1 assignment.....	11
12.	TIMING CHARACTERISTICS .....	12
12.1	Input setup timing setting.....	12
12.1.1	Parallel 24-bit RGB Timing Table .....	12
12.1.2	SYNC-DE mode timing diagram.....	14
12.1.3	DE mode timing diagram .....	15
12.2	System Bus Timing for RGB Interface .....	16
12.3	Power ON/OFF sequence.....	17
12.3.1	Power on sequence.....	17
12.3.2	Power off sequence.....	17
13.	CAPACITIVE TOUCH SCREEN PANEL SPECIFICATIONS.....	18
13.1	Mechanical characteristics.....	18
13.2	Electrical characteristics.....	18
14.	INSPECTION .....	19
14.1	Inspection condition .....	19
14.2	Inspection standard.....	20
15.	RELIABILITY TEST.....	21
16.	LEGAL INFORMATION .....	22



### 3. MODULE CLASSIFICATION INFORMATION

RV	T	35	H	H	T	N	W	C	00
1.	2.	3.	4.	5.	6.	7.	8.	9.	10.

NO.	PARAMETER	SYMBOL
1.	BRAND	RV – Riverdi
2.	PRODUCT TYPE	T – TFT Standard
3.	DISPLAY SIZE	35 – 3.5"
4.	MODEL SERIAL NO.	H – High Brightness, IPS
5.	RESOLUTION	H – 320 x 240 px
6.	INTERFACE	T – TFT LCD, RGB
7.	FRAME	N – Without Mounting Metal Frame
8.	BACKLIGHT TYPE	W – LED White
9.	TOUCH PANEL	C – With Capacitive Touch Panel
10.	VERSION	00 – (00-99)

#### 4. uxTouch ASSEMBLY

uxTouch are LCD TFT displays with specially designed projected capacitive touch panels. uxTouch display can be mounted without any hole in the housing. Our standard uxTouch displays include double-sided adhesive tape (DST) to stick TFT easily to the housing. Basic series include 4.3", 5.0", 7.0" and 10.1" display sizes.

uxTouch models with double-side adhesive tape can be mounted by connecting the glass to the housing. Riverdi recommends using support brackets assembled to display's back. An additional support will stiffen the whole structure and minimize the influence of external factors such as vibration. Figure 1 below shows examples of using support elements.

*Figure 1. Example of using support brackets*

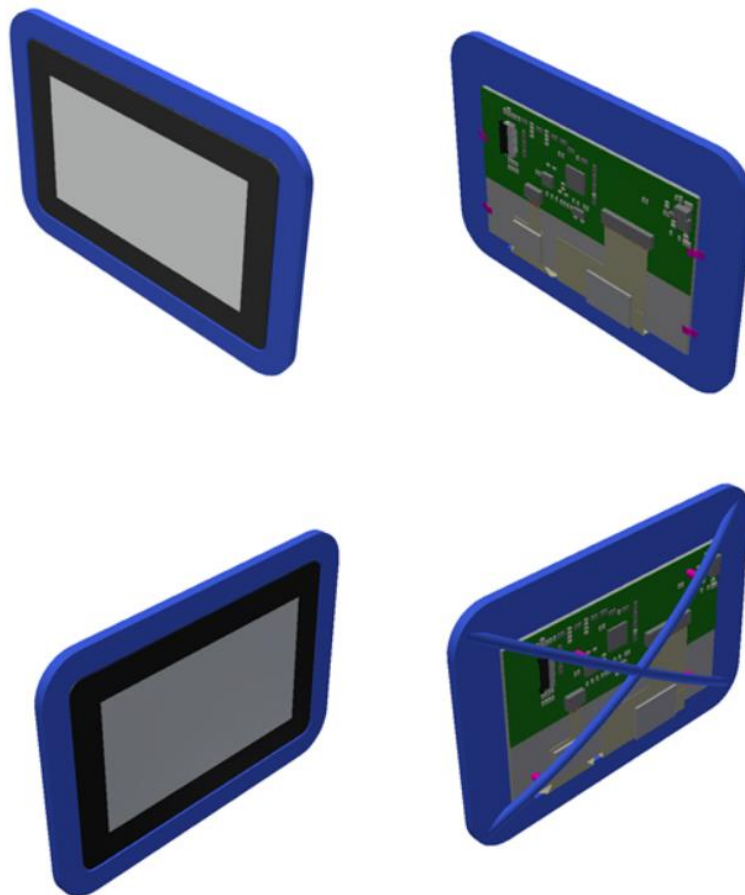

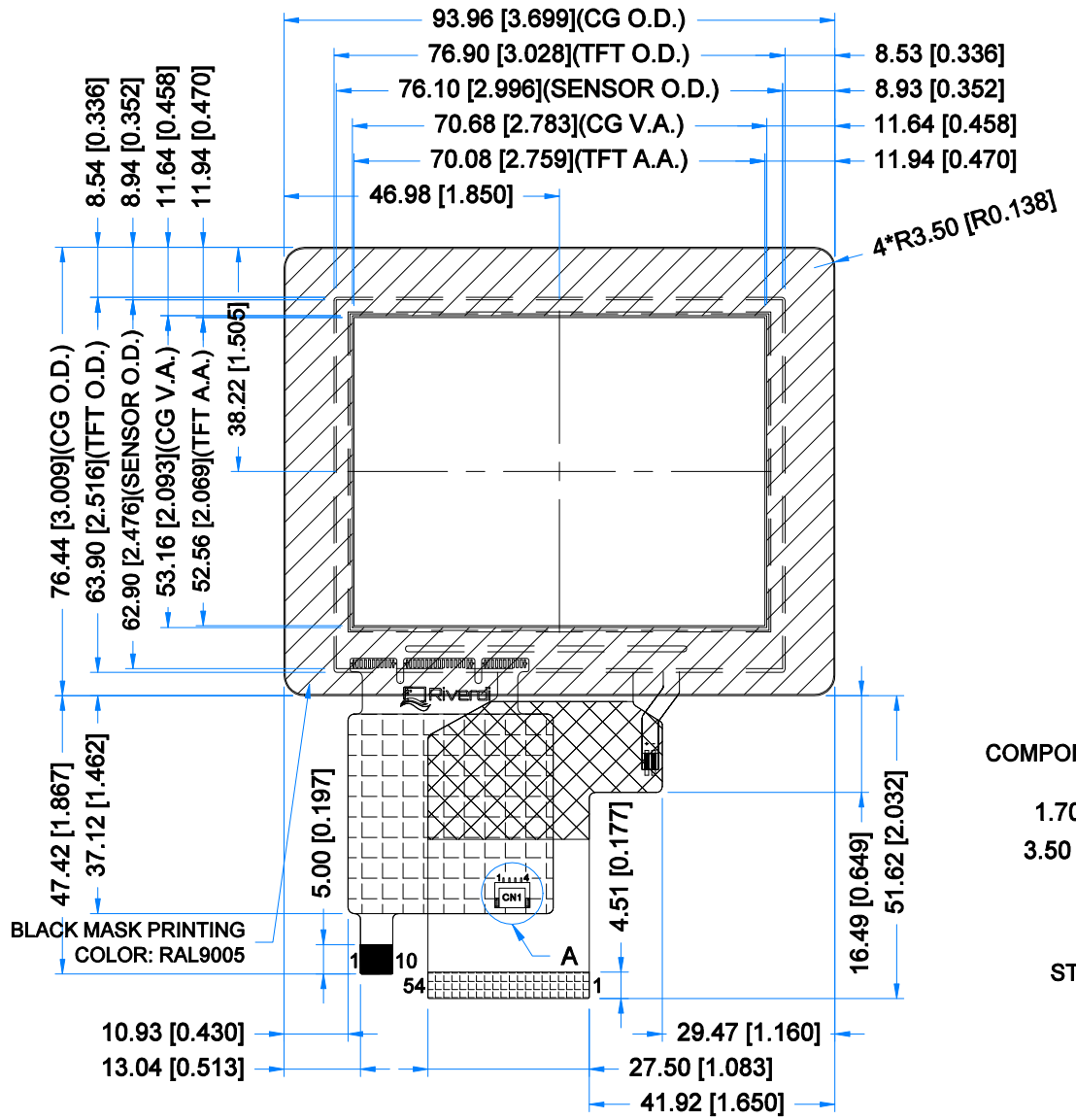

DETAIL A  
 SCALE 4:1

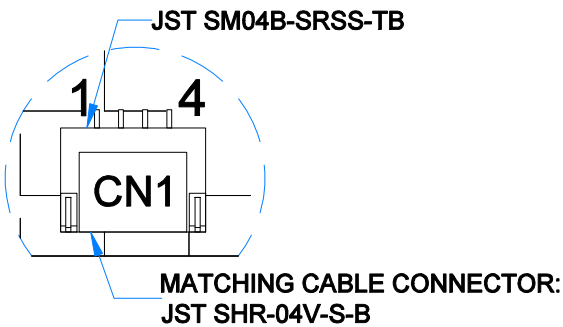

DETAIL B  
 SCALE 4:1

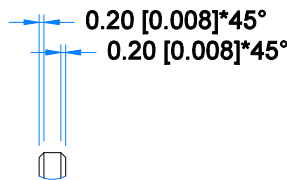

DETAIL C  
 SCALE 2:1

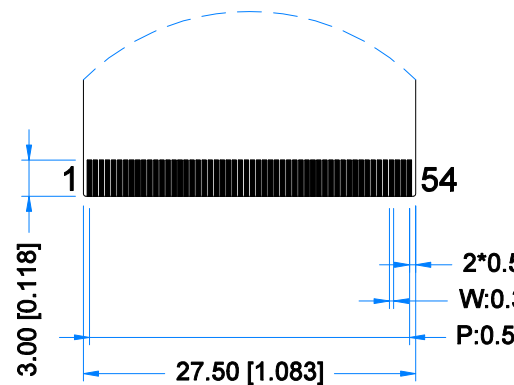

**TFT NOTES:**

1. LCD TYPE: TRANSMISSIVE, NORMALLY BLACK, IPS
2. RESOLUTION: 320x240
3. VIEWING ANGLE: FREE
4. DRIVER IC: ST7272A
5. DRIVING VOLTAGE: 3.3V
7. BACKLIGHT: 9 LEDs,  $V_f=9.6V$ ,  $I_f=60mA$

**TP NOTES:**

1. TP STRUCTURE: G+G
2. CG THICKNESS: 1.10mm [0.043inch]
3. DRIVER IC: ILI2132A
4. INTERFACE: USB; I2C; OPTIONAL UART
5. OPERATING VOLTAGE: 3.3V(CTP I2C); 5.0V(CTP USB);

**GENERAL NOTES:**

1. MODULE SURF
2. OPERATING T
3. STORAGE TE
4. WITHOUT IND  
 $\pm 0.3mm[0.012i$
5. RoHS COMPL



## 6. ABSOLUTE MAXIMUM RATINGS

PARAMETER	SYMBOL	MIN	MAX	UNIT	NOTE
Operating Ambient Temperature	$T_{OP}$	-20	70	°C	At 25±5°C
Storage Temperature	$T_{ST}$	-30	80	°C	
Operating Ambient Humidity	$H_{OP}$	10	-	% RH	
Power for Circuit Driving	$V_{DD}$	-0.3	5.0	V	

**Note** Exceeding the maximum values may cause improper operation or permanent damage to the unit.

## 7. ELECTRICAL CHARACTERISTICS

PARAMETER	SYMBOL	MIN	TYP	MAX	UNIT	
Power Supply for Analog Circuit	VDD	3.0	3.3	3.6	V	
Logic Input Voltage	Low Voltage	VIL	0	-		0.3 V <sub>DD</sub>
	High Voltage	VIH	0.7 V <sub>DD</sub>	-		V <sub>DD</sub>
Logic Output Voltage	Low Voltage	VOL	0	-		0.2 V <sub>DD</sub>
	High Voltage	VOH	0.8 V <sub>DD</sub>	-	-	
Current of Power Supply	Black Mode	I <sub>b</sub>	-	25	30	mA
	Standby Mode	I <sub>w</sub>	-	50	60	uA

## 8. BACKLIGHT ELECTRICAL CHARACTERISTICS

PARAMETER	SYMBOL	MIN	TYP	MAX	UNIT	NOTE
Backlight Driving Voltage	$V_F$	9.0	9.6	10.2	V	Notes 1,2
Backlight Driving Current	$I_F$	-	60	-	mA	
Backlight Power Consumption	$W_{BL}$	-	576	-	mW	
Backlight Lifetime	-	-	50,000	-	hours	Note 3

**Note 1.** Unless specified, the ambient temperature  $T_a=25^\circ\text{C}$ .

**Note 2.** The recommended operating conditions refer to a range in which operation of this product is guaranteed. Should this range be exceeded, the operation cannot be guaranteed even if the values may be without the absolute maximum ratings.

**Note 3.** Operating life means the period in which the LED brightness goes down to 50% of the initial brightness. Typical operating lifetime is the estimated parameter.



## 9. ELECTRO-OPTICAL CHARACTERISTICS

Optical characteristics are determined after the unit has been 'ON' and stable for approximately 30 minutes in a dark environment at 25 °C. The values specified are at an approximate distance 500mm from the LCD surface at a viewing angle of  $\Phi$  and  $\theta$  equal to 0°.

ITEM	SYMBOL	CONDITION	MIN	TYP	MAX	UNIT	RMK	NOTE
Response Time	Tr+Tf	$\theta=0^\circ$ $\varnothing=0^\circ$ Ta=25 °C	-	50	-	ms	FIG 2.	4
Contrast Ratio	Cr		-	700	-	---	FIG 3.	1
Luminance Uniformity	$\delta$ WHITE		-	75	-	%	FIG 3.	3
Surface Luminance	Lv		-	800	-	cd/m <sup>2</sup>	FIG 3.	2
Viewing Angle Range	$\theta$	$\varnothing = 90^\circ$	-	80	-	deg	FIG 4.	6
		$\varnothing = 270^\circ$	-	80	-	deg	FIG 4.	
		$\varnothing = 0^\circ$	-	80	-	deg	FIG 4.	
		$\varnothing = 180^\circ$	-	80	-	deg	FIG 4.	
CIE (x, y) Chromaticity	Rx	$\theta=0^\circ$ $\varnothing=0^\circ$ Ta=25 °C	0.573	0.613	0.653	-	FIG 3.	5
	Ry		0.317	0.357	0.397	-		
	Gx		0.324	0.364	0.404	-		
	Gy		0.263	0.603	0.643	-		
	Bx		0.110	0.150	0.190	-		
	By		0.069	0.109	0.149	-		
	Wx		0.277	0.317	0.357	-		
	Wy		0.299	0.339	0.379	-		

**Note 1.** Contrast Ratio (CR) is defined mathematically as below, for more information see Figure 3.

$$\text{Contrast Ratio} = \frac{\text{Average Surface Luminance with all white pixels (P1, P2, P3, P4, P5)}}{\text{Average Surface Luminance with all black pixels (P1, P2, P3, P4, P5)}}$$

**Note 2.** Surface luminance is the LCD surface from the surface with all pixels displaying white. For more information see Figure 3.

$$L_v = \text{Average Surface Luminance with all white pixels (P1, P2, P3, P4, P5)}$$

**Note 3.** The uniformity in surface luminance  $\delta$  WHITE is determined by measuring luminance at each test position 1 through 5, and then dividing the minimum luminance of 5 points luminance by maximum luminance of 5 points luminance. For more information see Figure 3.

$$\delta \text{ WHITE} = \frac{\text{Minimum Surface Luminance with all white pixels (P1, P2, P3, P4, P5)}}{\text{Maximum Surface Luminance with all white pixels (P1, P2, P3, P4, P5)}}$$

**Note 4.** Response time is the time required for the display to transition from white to black (Rise Time, Tr) and from black to white (Decay Time, Tf). For additional information see Figure 2. The test equipment is Autronic-Melchers's ConoScope series.

**Note 5.** CIE (x, y) chromaticity, the x, y value is determined by measuring luminance at each test position 1 through 5, and then make average value.



**Note 6.** Viewing angle is the angle at which the contrast ratio is greater than 2. For TFT module the contrast ratio is greater than 10. The angles are determined for the horizontal or x axis and the vertical or y axis with respect to the z axis which is normal to LCD surface. For more information see Figure 4.

**Note 7.** For viewing angle and response time testing, the testing data is based on Autronic-Melchers's ConoScope series. Instruments for Contrast Ratio, Surface Luminance, Luminance Uniformity, CIE the test data is based on TOPCON's BM-5 photo detector.

Figure 2. The definition of response time

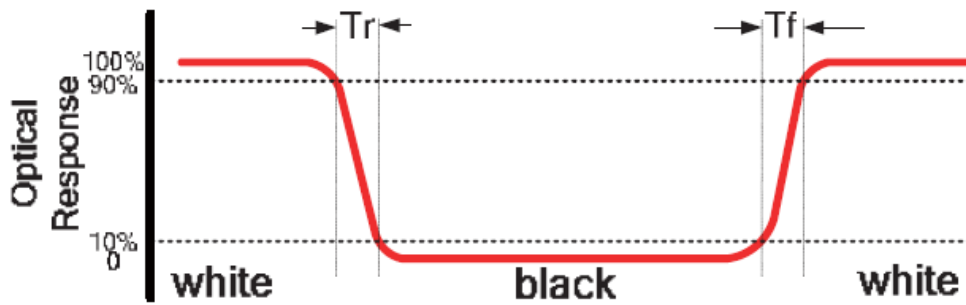
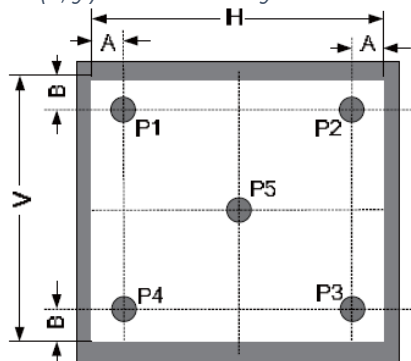

Figure 3. Measuring method for Contrast ratio, surface luminance, Luminance uniformity, CIE (x, y) chromaticity



A: 5mm

B: 5mm

H, V: Active Area

Light spot size  $\phi=5\text{mm}$ , 500mm distance from the LCD surface to detector lens.

Measurement instrument is TOPCON'S luminance meter BM-5

Figure 4. The definition of viewing angle

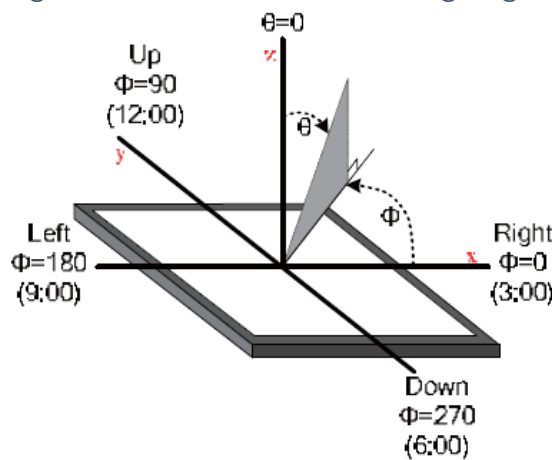





## 11.1 Touch panel assignment

PIN NO.	SYMBOL	DESCRIPTION	NOTE
1	USB_GND	USB_ Ground	
2	USB_VDD	USB Power for CTP, 5.0V	
3	USB_D-	USB _Data Signal -	
4	USB_D+	USB _Data Signal +	
5	I2C_GND	I2C _ Ground	
6	I2C_VDD	I2C _Power for CTP, 3.3 V	
7	I2C_RST	I2C _Reset Pin, Active low	Note 1
8	I2C_SCL	I2C _Clock Input	
9	I2C_INT	I2C _Interrupt Signal from CTP, Active low	
10	I2C_SDA	I2C _Data Signal	

**Note 1.** External pull-up resistors are required.

## 11.2 CON1 assignment

PIN NO.	SYMBOL	DESCRIPTION
1	USB_VDD	USB_Power for CTP, DC 5.0V
2	USB_D-	USB _Data Signal -
3	USB_D+	USB _Data Signal +
4	USB_GND	USB_Ground



## 12. TIMING CHARACTERISTICS

### 12.1 Input setup timing setting

RGB MODE SELECTION	DCLK	HSYNC	VSYNC	DE
SYNC-DE Mode	Input	Input	Input	Input
SYNC Mode	Input	Input	Input	GND
DE Mode	Input	GND	GND	Input

**Note.** "Input" means these signals are driven by host side.

#### 12.1.1 Parallel 24-bit RGB Timing Table

PARAMETER	SYMBOL	MIN	TYP	MAX	UNIT	NOTE	
DCLK Frequency	Fclk	5	6	8	MHz		
DCLK Period	Tclk	125	167	200	ns		
HSYNC	Period Time	Th	325	371	438	DCLK	
	Display Period	Thdisp	320				
	Back Porch	Thbp	3	43	43		SYNC mode back porch control by H_BLANKING [7:0] setting Thbp= H_BLANKING [7:0]
	Front Porch	Thfp	2	8	75		
	Pluse Width	Thw	2	4	43		
VSYNC	Period Time	Tv	244	260	289	HSYNC	
	Display Period	Tvdisp	240				
	Back Porch	Tvbp	2	12	12		SYNC mode back porch control by V_BLANKING [7:0] setting Tvbp= V_BLANKING [7:0]
	Front Porch	Tvfp	2	8	37		
	Pluse Width	Tvw	2	4	12		

**Note.** It's necessary to keep Tvbp=12 and Thbp=43 in sync mode. DE mode is unnecessary to keep it.

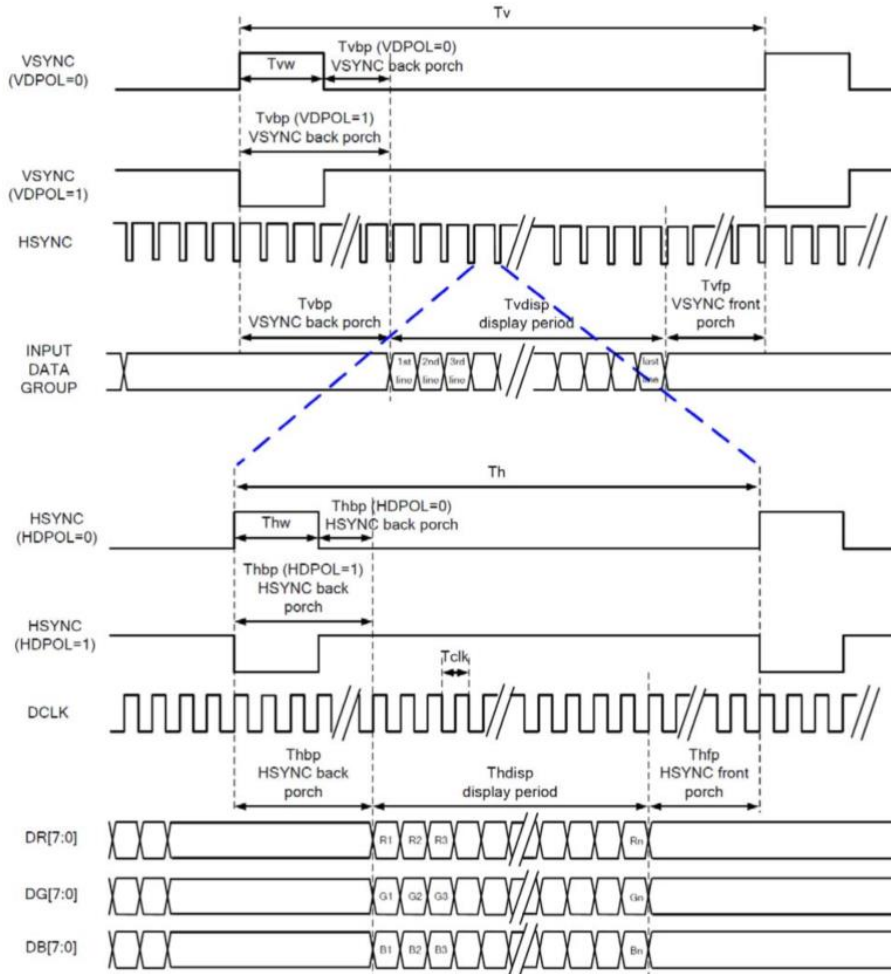



12.1.2 SYNC-DE mode timing diagram

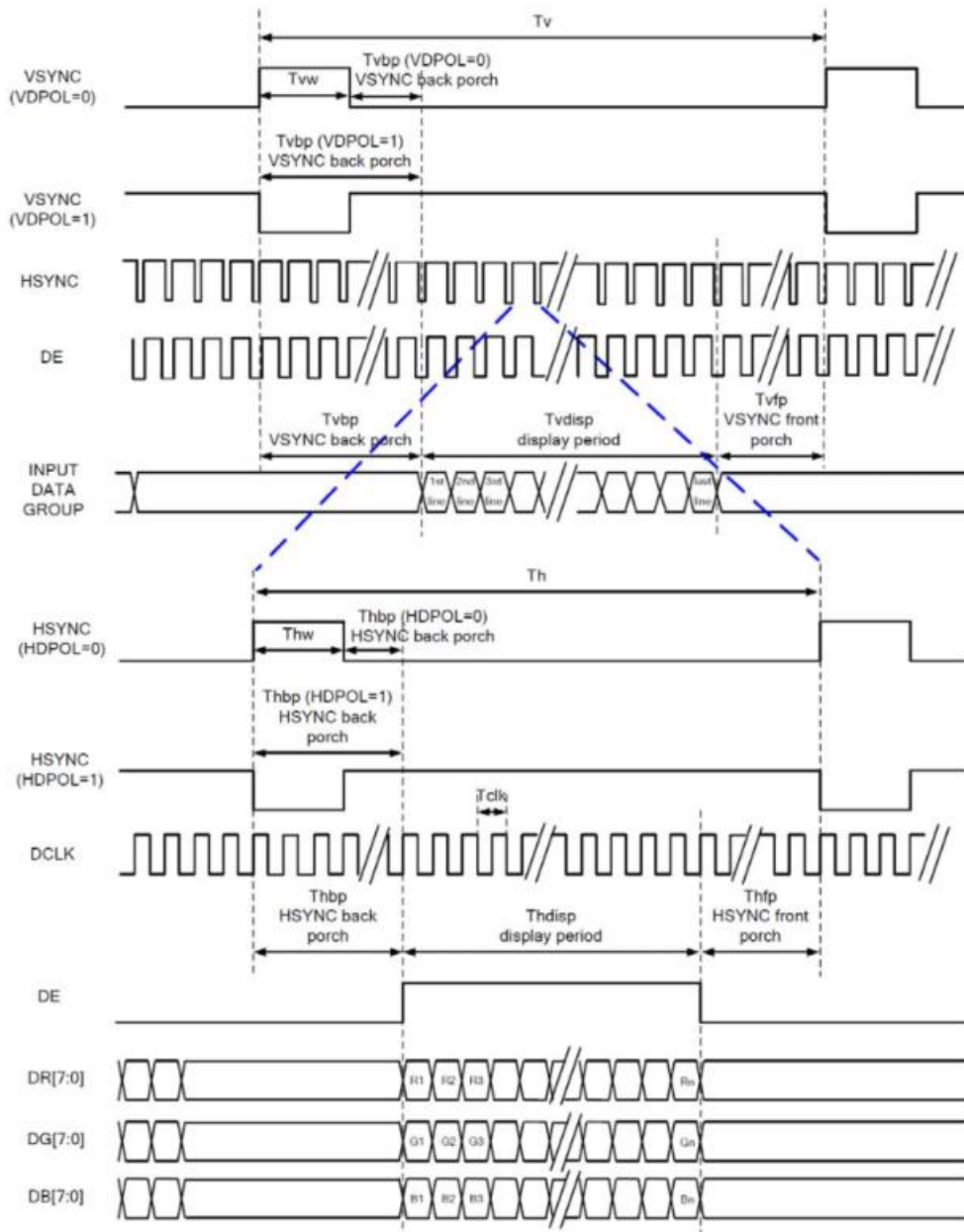



12.1.3 DE mode timing diagram

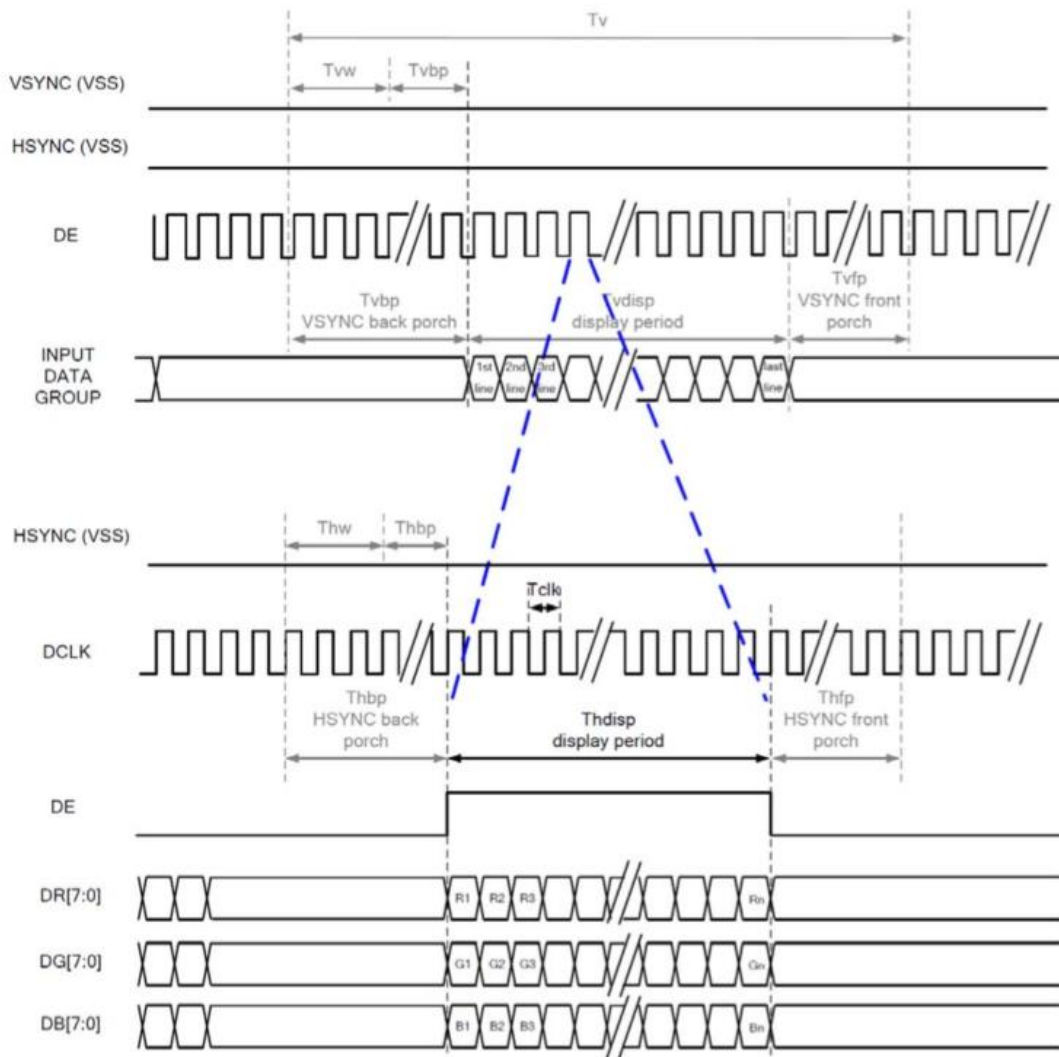



## 12.2 System Bus Timing for RGB Interface

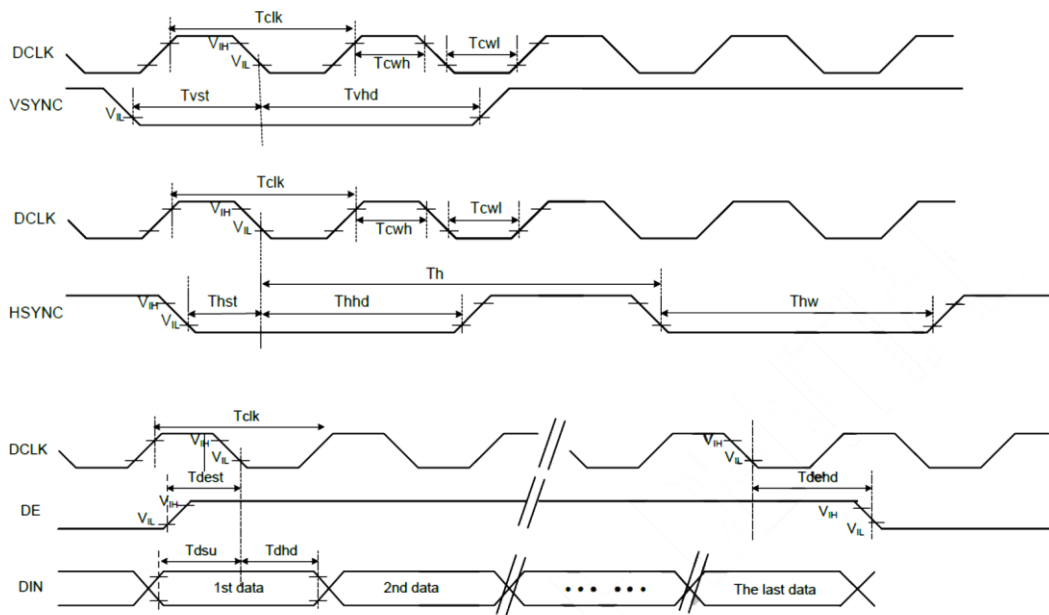

PARAMETER	SYMBOL	MIN	TYP	MAX	UNIT
CLK Pulse Duty	Tclk	40	50	60	%
HSYNC Width	Thw	2	-	-	DCLK
HSYNC Period	Th	55	60	65	CLK
VSYNC Setup Time	Tvst	12	-	-	ns
VSYNC Hold Time	Tvhd	12	-	-	
HSYNC Setup Time	Thst	12	-	-	
HSYNC Hold Time	Thhd	12	-	-	
Data Setup Time	Tdsu	12	-	-	
Data Hold Time	Tdhd	12	-	-	
DE Setup Time	Tdest	12	-	-	
DE Hold Time	Tdehd	12	-	-	



## 12.3 Power ON/OFF sequence

### 12.3.1 Power on sequence

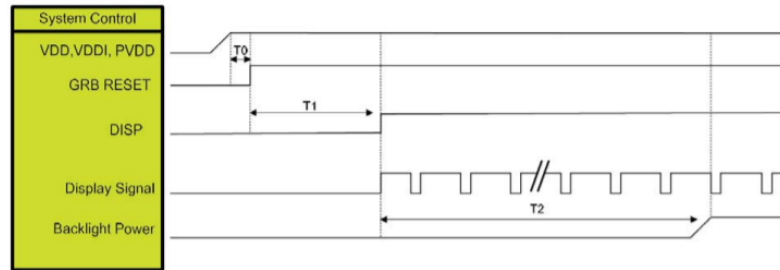

**Note.** Display signal: DCLK; VSYNC; HSYNC; DE; DR[7:0]; DG[7:0]; DB[7:0];

SYMBOL	DESCRIPTION	MIN. TIME	UNIT
T0	System power stability to GRB RESET signal	0	ms
T1	GRB RESET=" High" to DISP="High "	10	
T2	Display Signal output to Backlight Power on	250	

### 12.3.2 Power off sequence

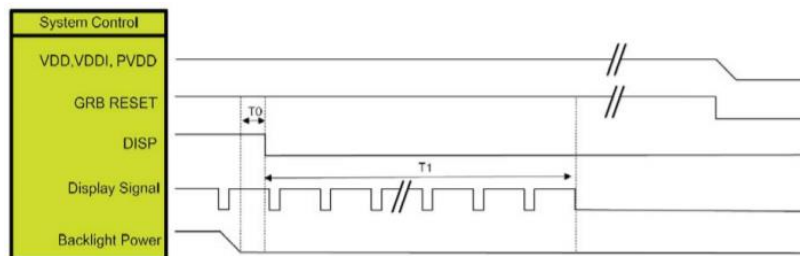

**Note.** Display signal: DCLK; VSYNC; HSYNC; DE; DR[7:0]; DG[7:0]; DB[7:0];

SYMBOL	DESCRIPTION	MIN. TIME	UNIT
T0	Backlight Power off to DISP=" Low"	5	ms
T1	DISP =" Low" to IC internal voltage discharge complete	80	ms



## 13. CAPACITIVE TOUCH SCREEN PANEL SPECIFICATIONS

### 13.1 Mechanical characteristics

DESCRIPTION	SPECIFICATION	REMARK
Touch Panel Size	3.5 inch	uxTouch
Outline Dimension of CTP	93.96 mm x 76.44 mm	
Product Thickness	2.15 mm	
Glass Thickness	1.1 mm	
CTP View Area	70.68 mm x 53.16 mm	
Sensor Active Area	72.08 mm x 54.56 mm	
Structure type	Glass + Glass	
Surface Hardness	7H	

### 13.2 Electrical characteristics

DESCRIPTION	SPECIFICATION	REMARK	
Power Consumption (IDD)	Active Mode	90 mA	Note 1
	Sleep Mode	10 mA	Note 1
Linearity	+/- 1.5mm		
Controller	ILI2132A		
Resolution	320 x 240		

**Note 1.** These 2 values will be verified on the real samples.

## 14. INSPECTION

Standard acceptance/rejection criteria for TFT module

### 14.1 Inspection condition

Ambient conditions:

- Temperature:  $25 \pm 2^{\circ}\text{C}$
- Humidity:  $(60 \pm 10) \%RH$
- Illumination: Single fluorescent lamp non-directive (300 to 700 lux)

Viewing distance:  $35 \pm 5\text{cm}$  between inspector bare eye and LCD.

Viewing Angle: U/D:  $45^{\circ}/45^{\circ}$ , L/R:  $45^{\circ}/45^{\circ}$

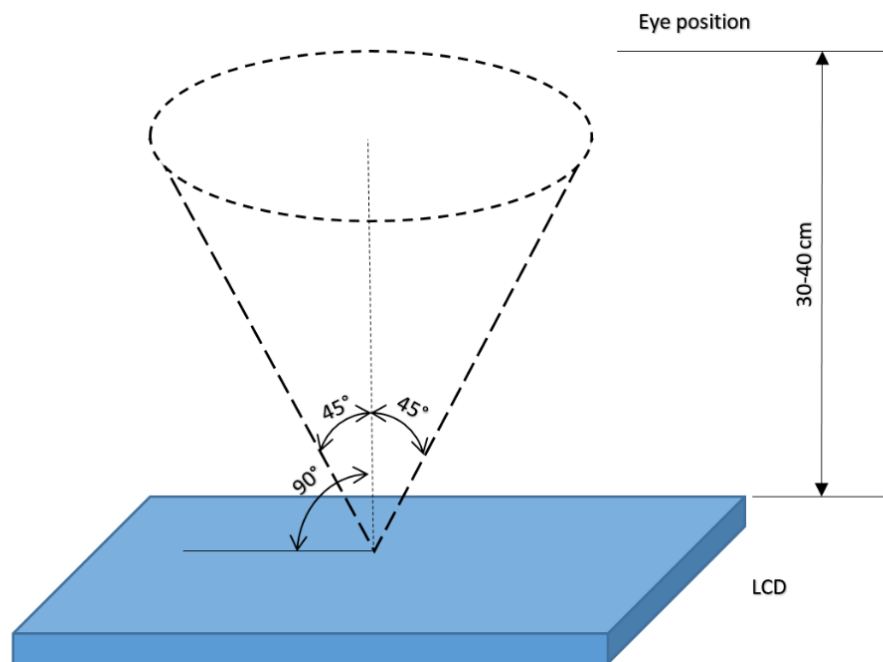



### 14.2 Inspection standard

ITEM		CRITERION		
Black spots, white spots, light leakage, Foreign Particle (round Type)	<p><math>D=(x+y)/2</math> Spots density: 10 mm</p>	3.5" ≤ Size ≤ 5"		
		Average Diameter	Qualified Qty	
		$D \leq 0.15$ mm	Ignored	
		$0.15 \text{ mm} < D \leq 0.3 \text{ mm}$	N≤3	
		$0.3 \text{ mm} < D$	Not allowed	
LCD black spots, white spots, light leakage (line Type)	<p>Spots density: 10 mm</p>	3.5" ≤ Size ≤ 5"		
		Length	Width	Qualified Qty
		-	$W \leq 0.03$	Ignored
		$L \leq 3.0$	$0.03 < W \leq 0.05$	2
		$L \leq 3.0$	$0.05 < W \leq 0.1$	1
	$3.0 < L$	$0.1 < W$	Not allowed	
Bright/Dark Dots	3.5" ≤ Size ≤ 5"			
	Item	Qualified Qty		
	Bright dots	N ≤ 1		
	Dark dots	N ≤ 2		
	Total Bright and Dark Dots	N ≤ 3		
Clear spots	Size < 5"			
	Average Diameter	Qualified Qty		
	$D < 0.2$ mm	Ignored		
	$0.2 \text{ mm} < D < 0.3 \text{ mm}$	3		
	$0.3 \text{ mm} < D < 0.5 \text{ mm}$	2		
	$0.5 \text{ mm} < D$	0		
	Spots density: 10 mm			
Polarizer bubbles	3.5" ≤ Size ≤ 5"			
	Average Diameter	Qualified Qty		
	$D \leq 0.2$ mm	Ignored		
	$0.2 \text{ mm} < D \leq 0.3 \text{ mm}$	2		
	$0.3 \text{ mm} < D \leq 0.5 \text{ mm}$	1		
	$0.5 \text{ mm} < D$	0		
	Total Q'ty	3		
Touch panel spots	Size < 5"			
	Average Diameter	Qualified Qty		



	D < 0.2 mm		Ignored
	0.2 mm < D < 0.4 mm		5
	0.4 mm < D < 0.5 mm		2
	0.5 mm < D		0
Touch panel white line scratch	Size < 5"		
	Length	Width	Qualified Qty
	-	W < 0.02	Ignored
	L < 3.0	0.02 < W < 0.05	2
	L < 2.5	0.05 < W < 0.08	2
	-	0.08 < W	0

## 15.RELIABILITY TEST

NO.	TEST ITEM	TEST CONDITION	NOTE
1	High Temperature Storage	80°C/120 hours	Note 1
2	Low Temperature Storage	-30°C/120 hours	
3	High Temperature Operating	70 °C /120 hours	
4	Low Temperature Operating	-20°C/120 hours	
5	High Temperature and High Humidity	Humidity 40°C, 90%RH, 120Hrs	
6	Thermal Cycling Test (No operation)	-20°C for 30min, 70°C for 30 min. 100 cycles. Then test at room temperature after 1 hour	Note 2
7	Vibration Test	Frequency: 10 ÷ 55 Hz. Stroke: 1.5 mm. Sweep: 10Hz ÷ 55Hz ÷ 10 Hz. 2 hours for each direction of X, Y, Z (Total 6 hours)	
8	Package Drop Test	Height: 60 cm 1 corner, 3 edges, 6 surfaces	

**Note 1.** Sample quantity for each test item is 5 ÷ 10 pcs.

**Note 2.** Before cosmetic and function test, the product must have enough recovery time, at least 2 hours at room temperature.



## 16.LEGAL INFORMATION

Riverdi grants the guarantee for the proper operation of the goods for a period of 12 months from the date of possession of the goods. If in a consequence of this guaranteed execution the customer has received the defects-free item as replacement for the defective item, the effectiveness period of this guarantee shall start anew from the moment the customer receives the defects-free item.

Information about device is the property of Riverdi and may be the subject of patents pending or granted. It is not allowed to copy or disclosed this document without prior written permission.

Riverdi endeavors to ensure that all contained information in this document is correct but does not accept liability for any error or omission. Riverdi products are in developing process and published information may be not up to date. Riverdi reserves the right to update and makes changes to Specifications or written material without prior notice at any time. It is important to check the current position with Riverdi.

Images and graphics used in this document are only for illustrative the purpose. All images and graphics are possible to be displayed on the range products of Riverdi, however the quality may vary. Riverdi is no liable to the buyer or to any third party for any indirect, incidental, special, consequential, punitive or exemplary damages (including without limitation lost profits, lost savings, or loss of business opportunity) relating to any product, service provided or to be provided by Riverdi, or the use or inability to use the same, even if Riverdi has been advised of the possibility of such damages.

Riverdi products are not fault tolerant nor designed, manufactured or intended for use or resale as on line control equipment in hazardous environments requiring fail-safe performance, such as in the operation of nuclear facilities, aircraft navigation or communication systems, air traffic control, direct life support machines or weapons systems in which the failure of the product could lead directly to death, personal injury or severe physical or environmental damage ('High-Risk Activities'). Riverdi and its suppliers specifically disclaim any expressed or implied warranty of fitness for High-Risk Activities. Using Riverdi products and devices in 'High-Risk Activities' and in any other application is entirely at the buyer's risk, and the buyer agrees to defend, indemnify and hold harmless Riverdi from all damages, claims or expenses resulting from such use. No licenses are conveyed, implicitly or otherwise, under any Riverdi intellectual property rights.

Hi, I am here to help you!  
If you have any additional  
questions, please contact  
our support via email:  
[contact@riverdi.com](mailto:contact@riverdi.com)



## X-ON Electronics

Largest Supplier of Electrical and Electronic Components

*Click to view similar products for [TFT Displays & Accessories](#) category:*

*Click to view products by [Riverdi](#) manufacturer:*

Other Similar products are found below :

[F3ET2-005-150](#) [HDA430T-3G1H](#) [NB7W-KBA04](#) [NB-ATT01](#) [NB5Q-ATT01](#) [NB5Q-KBA04](#) [NB-CN001](#) [OAI-80038AA-2008-A](#) [315-U004B15300](#) [TCG121WXLRXVNNANX35](#) [EIC-LCD-1080P](#) [T-55619GD065J-LW-ABN](#) [NLB150XG02L-01](#) [NL192108AC10-01D](#) [NL6448AC18-08F](#) [NL8060BC26-35BA](#) [NL6448BC26-26D](#) [NL8060BC31-50F](#) [TM070DDHG03-40](#) [PTPW16-070WV1S02](#) [PTPW16-084SV1S02](#) [MTD0300ECP06DF-1](#) [4DLCD-35480320-CTP-IPS](#) [4DLCD-35480320-IPS](#) [4DLCD-35480320-RTP-IPS](#) [4DLCD-50800480-CTP-IPS](#) [RFA6400E-AWH-DNG](#) [RFE430V-AZW-DNS](#) [RFF70BQ-1IW-DBG](#) [RFF70VA2-1IW-DHS](#) [RFH700A8-AYH-MNN](#) [RFK101VF-1YH-LHG](#) [RFS52VA-1ZH-DHN](#) [SM-RVT101HVHFWN00](#) [SM-RVT101HVHNWC00](#) [SM-RVT101HVHNWCA0](#) [SM-RVT101HVHNWN00](#) [SM-RVT101HVLFWCA0](#) [SM-RVT101HVLNWCA0](#) [SM-RVT35HHTFWCA0](#) [SM-RVT35HHTNWCA0](#) [SM-RVT43HLTFWCA0](#) [SM-RVT43HLTNWCA0](#) [SM-RVT50HQTFWCA0](#) [SM-RVT50HQTNWCA0](#) [SM-RVT70AQLFWR00](#) [SM-RVT70AQLNWR00](#) [SM-RVT70HSLFWCA0](#) [SM-RVT70HSMFWCA0](#) [SM-RVT70HSMFWN00](#)