



## RiTFT-43 series

### 4.3" EVE3 SERIES LCD TFT

Rev.1.0

2018-10-22

ITEM	CONTENTS	UNIT
LCD Type	TFT/Transmissive/Normally white	/
Size	4.3	Inch
Viewing Direction	12:00 (without image inversion)	O' Clock
Gray Scale Inversion Direction	6:00	O' Clock
Number of Dots	480 x (RGB) x 272	/
Driver IC	BT81x	/
Interface Type	SPI/QSPI	/
Module Memory Size	1 MB (BT81x) + 64 Mb (external flash)	/
Color Depth	16.7M	/
Pixel Arrangement	RGB Vertical Stripe	/
Surface Treatment	Anti-glare / Clear (for CTP)	/
Input Voltage	3.3	V

**Note 1:** RoHS, REACH SVHC compliant

**Note 2:** LCM weight tolerance:  $\pm 5\%$ .



## REVISION RECORD

REVNO.	REVDATE	CONTENTS	REMARKS
1.0	2018-10-22	Initial Release	

### CONTENTS

REVISION RECORD.....	2
CONTENTS .....	2
1 MODULE CLASSIFICATION INFORMATION.....	3
2 ASSEMBLY GUIDE - INTEGRATION .....	4
2.1 UxTouch assembly .....	5
2.2 Mounting frame .....	6
3 MODULE DRAWING .....	4
4 ABSOLUTE MAXIMUM RATINGS .....	5
5 ELECTRICAL CHARACTERISTICS .....	5
6 BACKLIGHT CHARACTERISTICS .....	5
7 ELECTRO-OPTICAL CHARACTERISTICS .....	5
8 INTERFACE DESCRIPTION .....	7
9 BT8x CONTROLLER SPECIFICATIONS .....	8
9.1 Serial host interface .....	8
9.2 Block Diagram .....	8
9.3 Host interface SPI mode 0.....	9
9.4 Backlight driver block diagram .....	9
10 LCD TIMING CHARACTERISTICS.....	9
10.1 Clock and data input time diagram .....	9
10.2 Parallel RGB timing table .....	10
11 TOUCH SCREEN PANEL SPECIFICATIONS.....	10
11.1 Electrical characteristics.....	10
11.1.1 For capacitive touch panel .....	10
11.1.2 For resistive touch panel .....	10
11.2 Mechanical characteristics.....	11
11.2.1 For capacitive touch panel .....	11
11.2.2 For resistive touch panel .....	11
12 INSPECTION .....	12
12.1 Inspection condition .....	12
12.2 Inspection standard .....	13
13 RELIABILITY TEST.....	16
14 LEGAL INFORMATION .....	17

## 1 MODULE CLASSIFICATION INFORMATION

<b>RV</b>	<b>T</b>	<b>43</b>	<b>X</b>	<b>L</b>	<b>B</b>	<b>X</b>	<b>W</b>	<b>X</b>	<b>00</b>
1.	2.	3.	4.	5.	6.	7.	8.	9.	10.

1.	<b>BRAND</b>	<b>RV – Riverdi</b>
2.	<b>PRODUCT TYPE</b>	<b>T – TFT Standard</b> F – TFT Custom
3.	<b>DISPLAY SIZE</b>	<b>43 – 4.3”</b>
4.	<b>MODEL SERIAL NO.</b>	A (A-Z) Ux - UxTouch
5.	<b>RESOLUTION</b>	<b>L– 480x272 px</b>
6.	<b>INTERFACE</b>	<b>B – TFT + Controller BT81x</b>
7.	<b>FRAME</b>	N – No Frame F – Mounting Frame
8.	<b>BACKLIGHT TYPE</b>	<b>W – LED White</b>
9.	<b>TOUCH PANEL</b>	N – No Touch Panel R – Resistive Touch Panel C – Capacitive Touch Panel
10.	<b>VERSION</b>	00 (00-99)

## 2 ASSEMBLY GUIDE - INTEGRATION

Three options of rear side adhesive tape are available: double side adhesive tape 0.2 mm with 3M 467MP glue, foam double side adhesive tape 0.5 mm with DST 3M 9495LE glue or without any tape. There are also two versions of glass color: black and white.

Rear side adhesive tape options:

		
Double side adhesive tape with DST 3M 9495LE glue (total thickness 0.2mm)	Foam double side adhesive tape with 3M 9495LE glue (total thickness 0.5mm)	Without tape

Cover glass color options:



Product options:

NAME OF THE PRODUCT	PART NUMBER	DESCRIPTION
<b>RiTFT-43</b>	RVT43ALBNWN00	BT816, no touch panel
<b>RiTFT-43-RES</b>	RVT43ALBNWR00	BT816, resistive touch panel
<b>RiTFT-43-CAP</b>	RVT43ALBNWC00	BT815, capacitive touch panel
<b>RiTFT-43- FR</b>	RVT43ALBFWN00	BT816, no touch panel, mounting frame
<b>RiTFT-43-RES-FR</b>	RVT43ALBFWR00	BT816, resistive touch panel, mounting frame
<b>RiTFT-43-CAP-FR</b>	RVT43ALBFWC00	BT815, capacitive touch panel, mounting frame
<b>RiTFT-43-CAP-UX</b>	RVT43ULBNWC00	BT815, uxTouch, black cover glass, 0.2mm DST
	RVT43ULBNWC01	BT815, uxTouch, black cover glass, 0.5 mm DST
	RVT43ULBNWC02	BT815, uxTouch, black cover glass, no DST
	RVT43ULBNWC03	BT815, uxTouch, white cover glass, 0.2mm DST
	RVT43ULBNWC04	BT815, uxTouch, white cover glass, 0.5 mm DST
	RVT43ULBNWC05	BT815, uxTouch, white cover glass, no DST

## 2.1 UxTouch assembly

UxTouch are LCD TFT displays with specially designed projected capacitive touch panels. UxTouch display can be mounted without any hole in the housing. Our standard UxTouch displays include double-sided adhesive tape (DST) to stick TFT easily to the housing. Basic series include 4.3", 5.0" and 7.0" display sizes.

UxTouch models with double-side adhesive tape (PN with endings 00, 01, 03, 04) can be mounted by connecting the glass to the housing. Riverdi recommends to use support brackets assembled to display's back. An additional support will stiffen the whole structure and minimize the influence of external factors such as vibration. Figure 1 and Figure 2 below show examples of using support elements.

Figure 1. Example of using support brackets

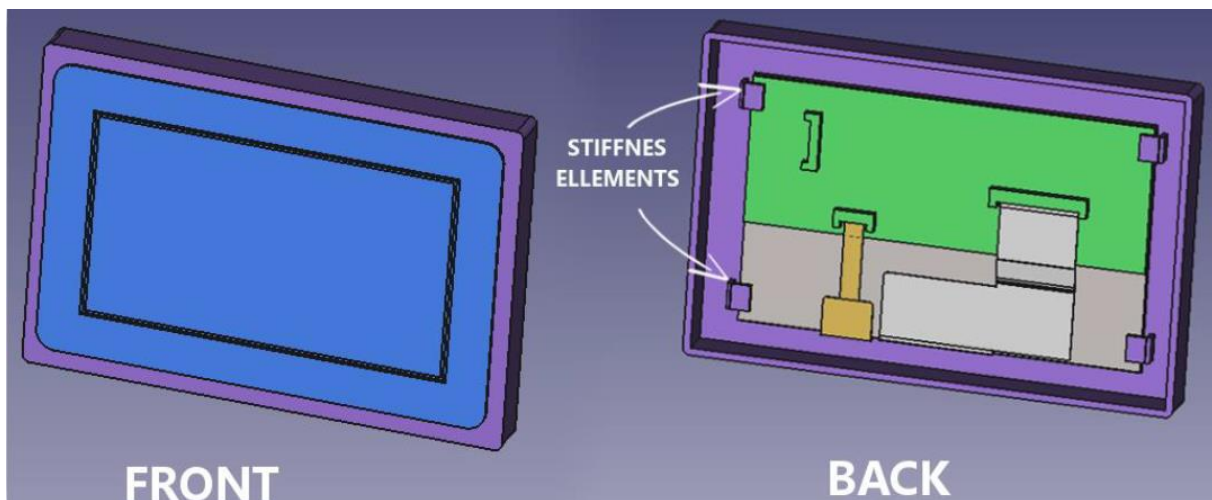
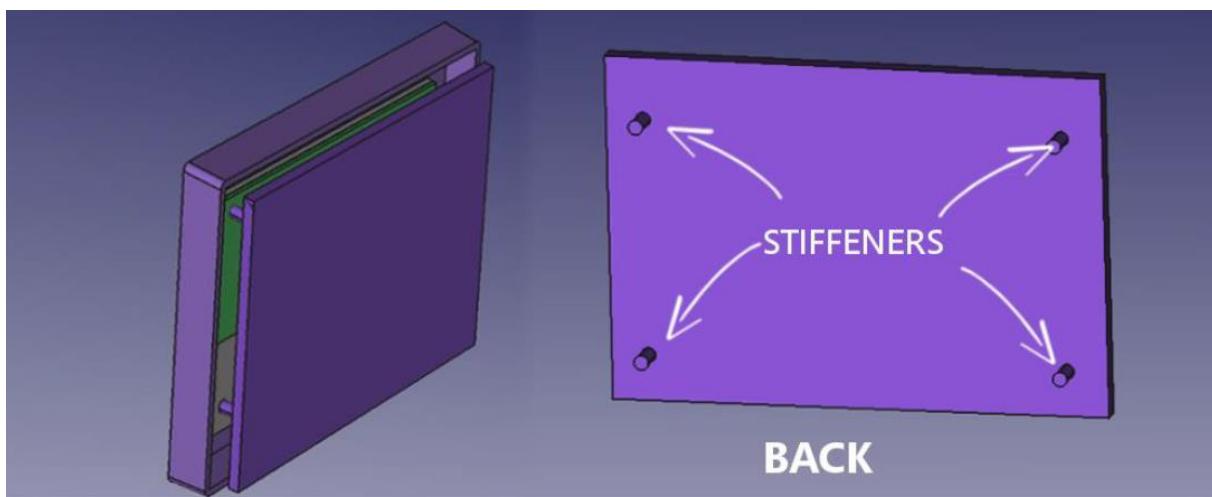

Figure 2. Example of using fixing sleeves



## 2.2 Mounting frame

For dimensions 3.5", 4.3", 5.0" and 7.0" the product with mounting frame version is available. Thanks to the four catches attached to the side, frame provides strong assembly to the surface by mounting element (like the screw, see Figure 3). The frames are specially designed to fit Riverdi products perfectly. The diameter of the mounting hole is 3.5mm.

*Figure 3. Mounting frame*

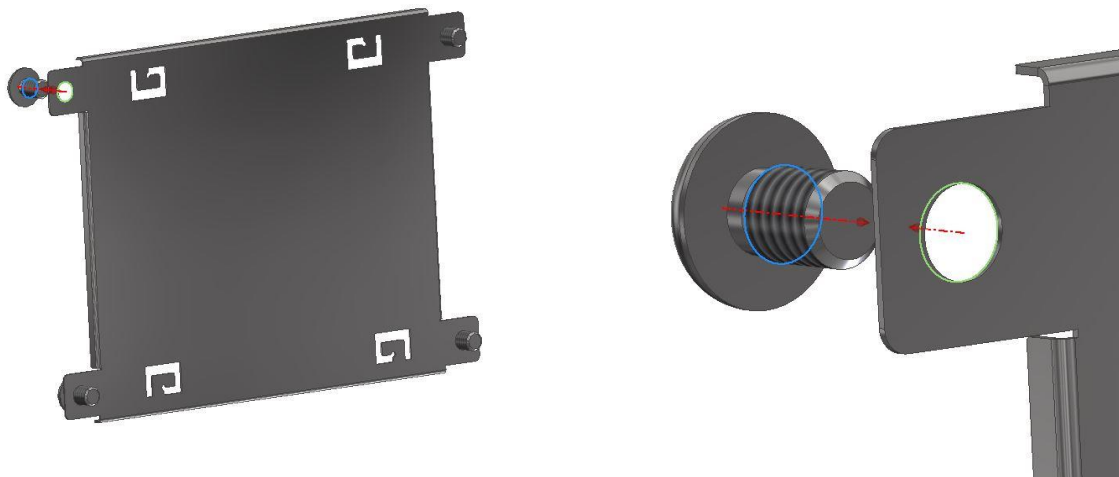

# RiTFT-43

Revision:	
1.0	

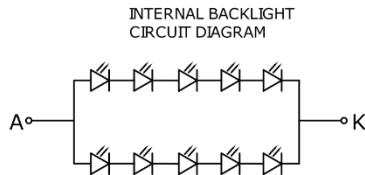
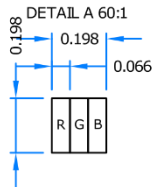
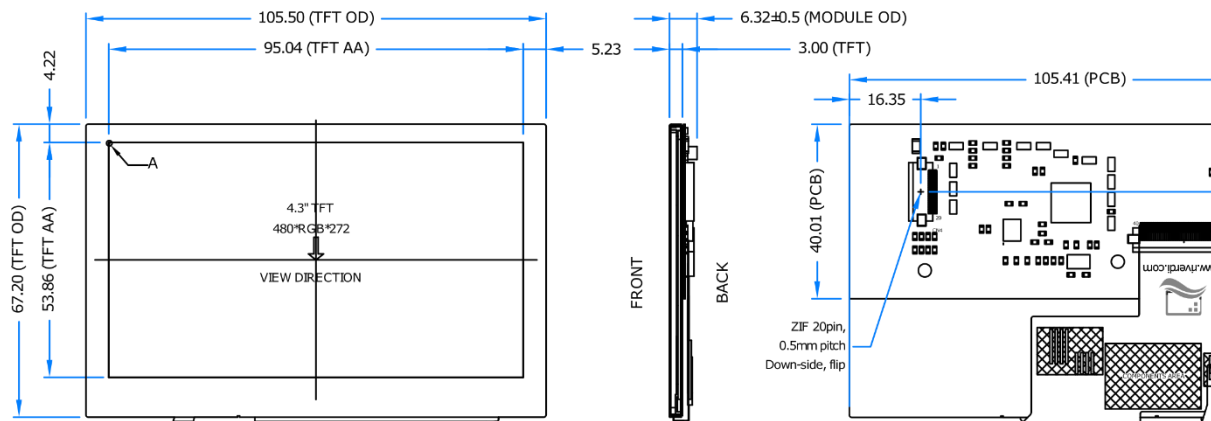

**GENERAL NOTES:**

1. DISPLAY TYPE: TFT, TRANSMISSIVE, NORMALLY WHITE
2. OPERATION VOLTAGE: VDD=3.3V
3. VIEWING DIRECTION: 12 O'CLOCK
4. IC CONTROLLER: BT816
5. OPERATING TEMP.: -20°C ~ 70°C
6. STORAGE TEMP.: -30°C ~ 80°C
7. LED BACKLIGHT: 10-LED WHITE, BUILT-IN INVERTER
8. SURFACE LUMINANCE: 550 cd/m<sup>2</sup>

9. GENERAL TOLERANCE: ±0.2 mm
10. RoHS COMPLIANT

PN: RVT43ALBNWN0
SN: #####
DRAWN: P.M.
CHECKED:
APPR:

Revision:	
1.0	

# RiTFT-43-FR

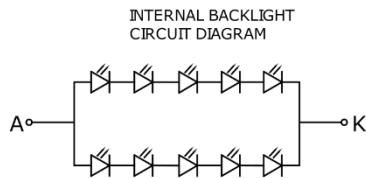
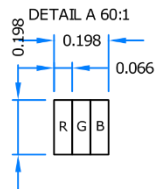
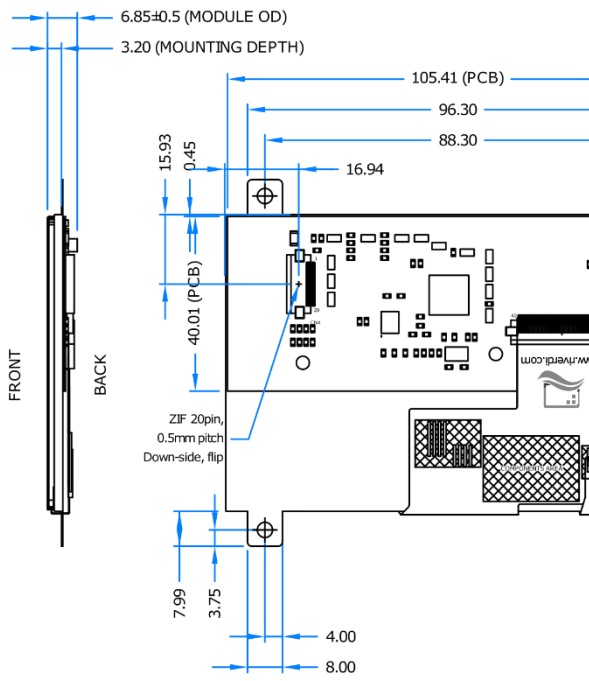
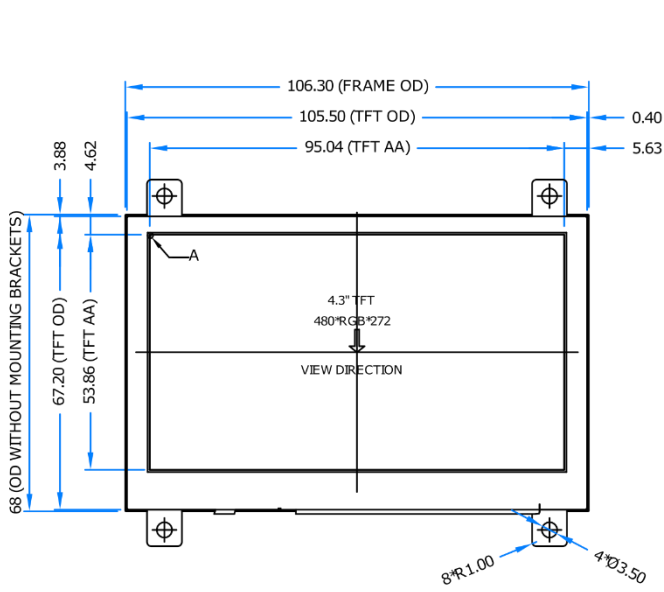

**GENERAL NOTES:**  
 1. DISPLAY TYPE: TFT, TRANSMISSIVE, NORMALLY WHITE  
 2. OPERATION VOLTAGE: VDD=3.3V  
 3. VIEWING DIRECTION: 12 O'CLOCK  
 4. IC CONTROLLER: BT816  
 5. OPERATING TEMP.: -20°C ~ 70°C  
 6. STORAGE TEMP.: -30°C ~ 80°C  
 7. LED BACKLIGHT: 10-LED WHITE, BUILT-IN INVERTER  
 8. SURFACE LUMINANCE: 550 cd/m<sup>2</sup>

9. GENERAL TOLERANCE: ±0.2 mm  
 10. RoHS COMPLIANT

PN: RVT43ALBFWN0  
 SN: ####  
 DRAWN: P.M.  
 CHECKED:  
 APPR:



Revision:	
1.0	

# RiTFT-43-CAP

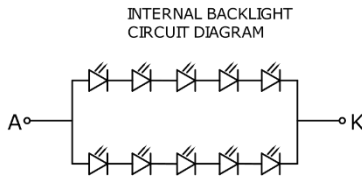
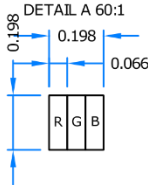
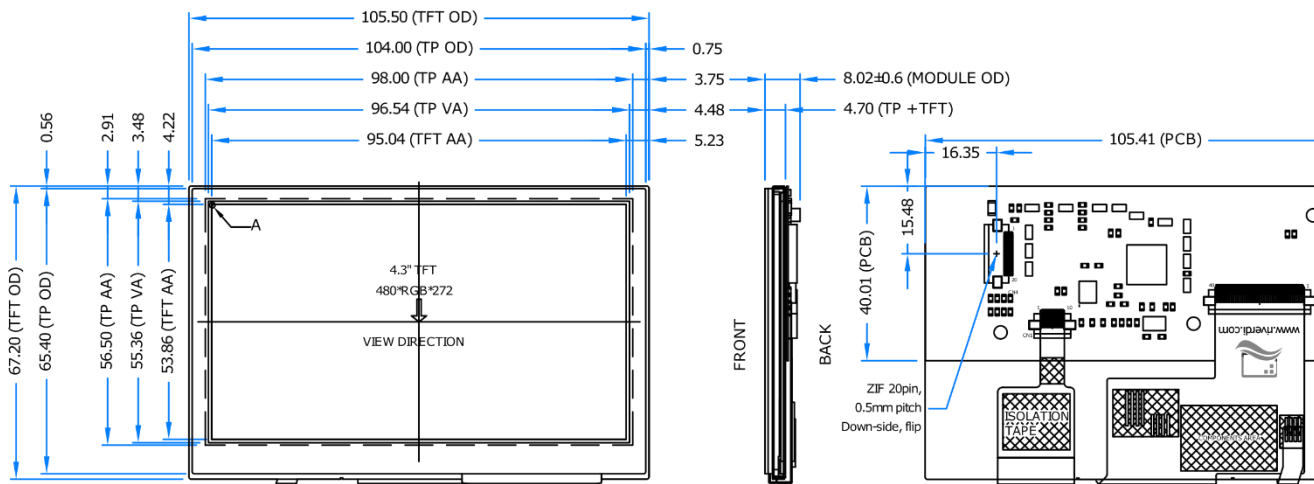

**GENERAL NOTES:**

1. DISPLAY TYPE: TFT, TRANSMISSIVE, NORMALLY WHITE
2. OPERATION VOLTAGE: VDD=3.3V
3. VIEWING DIRECTION: 12 O'CLOCK
4. IC CONTROLLER: BT815
5. OPERATING TEMP.: -20°C ~ 70°C
6. STORAGE TEMP.: -30°C ~ 80°C
7. LED BACKLIGHT: 10-LED WHITE, BUILT-IN INVERTER
8. SURFACE LUMINANCE: 500 cd/m<sup>2</sup>

9. GENERAL TOLERANCE: ±0.2 mm
10. RoHS COMPLIANT

PN: RVT43ALBNWCO
SN: #####
DRAWN: P.M.
CHECKED:
APPR:



# RiTFT-43-RES

Revision:	
1.0	

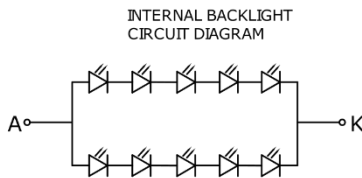
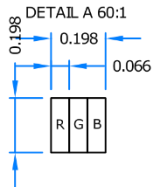
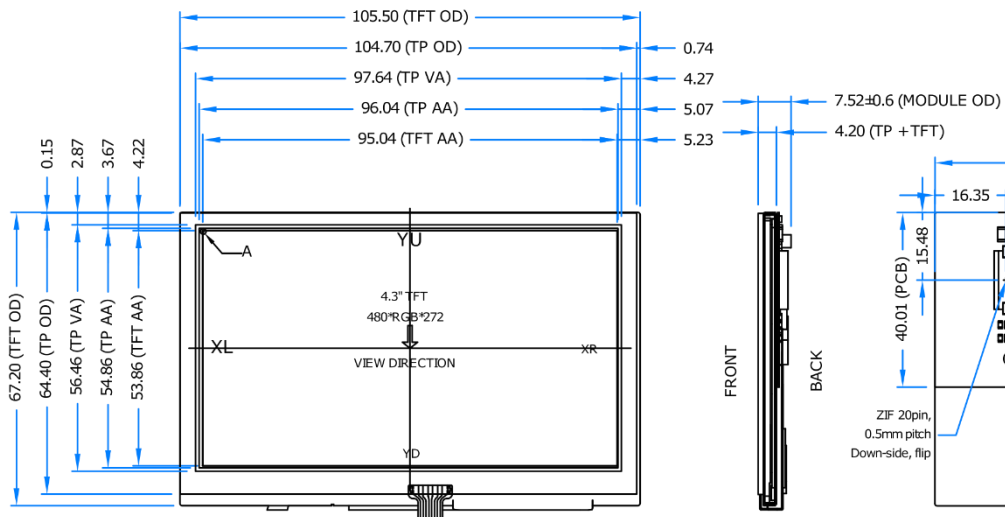

**GENERAL NOTES:**

1. DISPLAY TYPE: TFT, TRANSMISSIVE, NORMALLY WHITE
2. OPERATION VOLTAGE: VDD=3.3V
3. VIEWING DIRECTION: 12 O'CLOCK
4. IC CONTROLLER: BT816
5. OPERATING TEMP.: -20°C ~ 70°C
6. STORAGE TEMP.: -30°C ~ 80°C
7. LED BACKLIGHT: 10-LED WHITE, BUILT-IN INVERTER
8. SURFACE LUMINANCE: 440 cd/m<sup>2</sup>

9. GENERAL TOLERANCE: ±0.2 mm
10. RoHS COMPLIANT

PN: RVT43ALBNWR0
SN: #####
DRAWN: P.M.
CHECKED:
APPR:

# RiTFT-43-RES-FR

Revision:	
1.0	

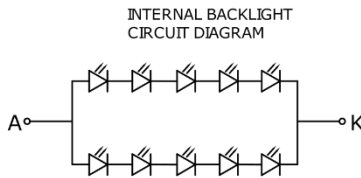
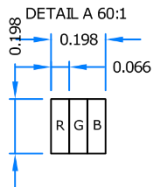
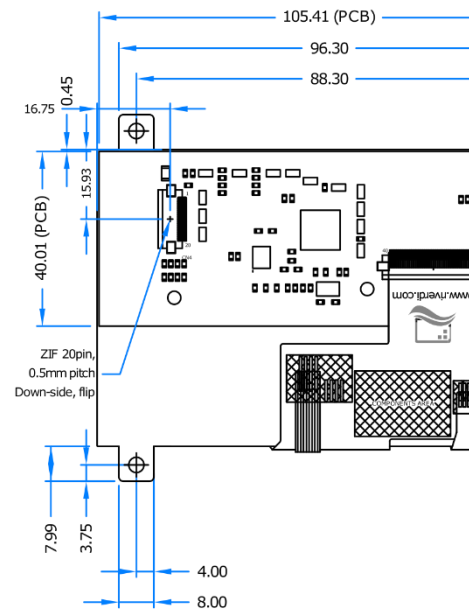
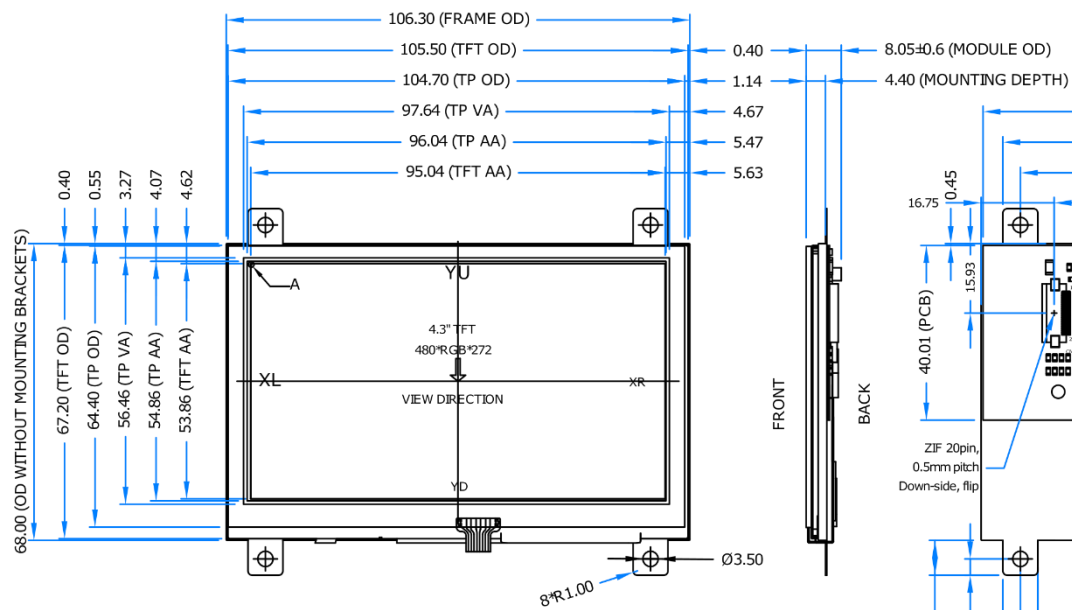

**GENERAL NOTES:**

1. DISPLAY TYPE: TFT, TRANSMISSIVE, NORMALLY WHITE
2. OPERATION VOLTAGE: VDD=3.3V
3. VIEWING DIRECTION: 12 O'CLOCK
4. IC CONTROLLER: BT816
5. OPERATING TEMP.: -20°C ~ 70°C
6. STORAGE TEMP.: -30°C ~ 80°C
7. LED BACKLIGHT: 10-LED WHITE, BUILT-IN INVERTER
8. SURFACE LUMINANCE: 440 cd/m<sup>2</sup>

9. GENERAL TOLERANCE: ±0.2 mm
10. RoHS COMPLIANT

PN: RVT43ALBFWRO
SN: ###
DRAWN: P.M.
CHECKED:
APPR:

# RiTFT-43-UX

Revision:	
1.0	

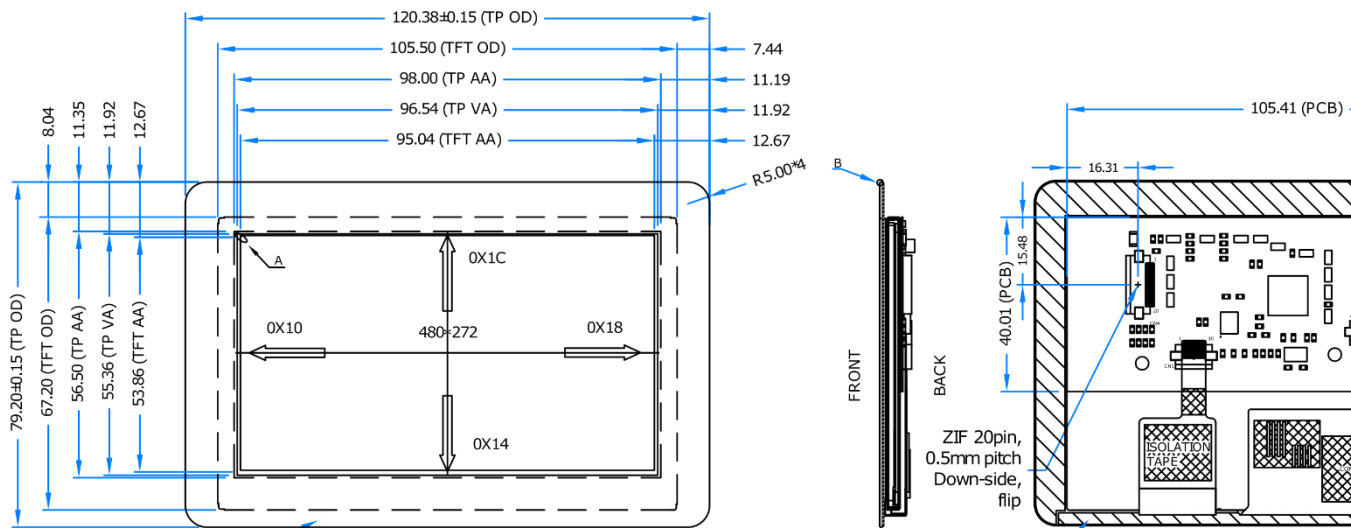

PRINT ON REAR SIDE OF COVER  
COLOR: PANTONE BLACK or WHITE

DETAIL A  
60:1

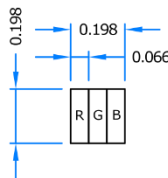

REAR SIDE ADHESIVE TAPE (see Chapter 2)

INTERNAL BACKLIGHT  
CIRCUIT DIAGRAM

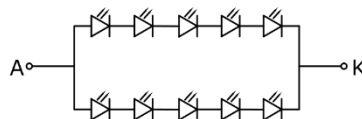

DETAIL B  
SCALE 4:1

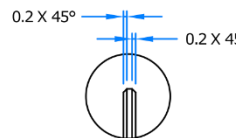

**GENERAL NOTES:**

1. DISPLAY TYPE: TFT, TRANSMISSIVE, NORMALLY WHITE
2. OPERATION VOLTAGE: VDD=3.3V
3. VIEWING DIRECTION: 12 O'CLOCK
4. IC CONTROLLER: BT815
5. OPERATING TEMP.: -20°C ~ 70°C
6. STORAGE TEMP.: -30°C ~ 80°C
7. LED BACKLIGHT: 10-LED WHITE, BUILT-IN INVERTER
8. SURFACE LUMINANCE: 500 cd/m<sup>2</sup>

9. GENERAL TOLERANCE: ±0.2 mm
10. RoHS COMPLIANT

PN: RVT43ULBNWCC
SN: ####
DRAWN: P.M.
CHECKED:
APPR:

## 4 ABSOLUTE MAXIMUM RATINGS

PARAMETER	SYMBOL	MIN	MAX	UNIT
Supply Voltage for Logic	VDD	0	4.0	V
Supply Voltage for LED inverter	BLVDD	0	7.0	V
Input Voltage for Logic	VIN	0	4.0	V
LED forward current (each LED)	IF	-	25	mA
Operating Temperature	T <sub>OP</sub>	-20	70	°C
Storage Temperature	T <sub>ST</sub>	-30	80	°C
Humidity	RH	-	90% (Max 60°C)	RH

## 5 ELECTRICAL CHARACTERISTICS

PARAMETER	SYMBOL	MIN	TYP	MAX	UNIT	NOTES
Supply Voltage For Module	VDD	3.0	3.3	3.6	V	
Input Voltage for LED Inverter	BLVDD	2.8	5.0	5.5	V	
LED Backlight Current	IDD <sub>backlight</sub>	-	260	325	mA	BLVDD=3.3V
LED Backlight Current	IDD <sub>backlight</sub>	-	150	187	mA	BLVDD=5V
Input Voltage 'H' level	V <sub>IH</sub>	0.7VDD	-	VDD	V	
Input Voltage 'L' level	V <sub>IL</sub>	0	-	0.2VDD	V	
Input Current	I <sub>in</sub>		TBD		mA	
Input Current for CTP	I <sub>inc</sub>		TBD		mA	

**Note:** The LED life time is defined as the module brightness decrease to 50% original brightness at Ta=25°C.

## 6 BACKLIGHT CHARACTERISTICS

ITEM	SYMBOL	MIN	TYP	MAX	UNIT
Voltage for LED backlight	V <sub>I</sub>	-	16	-	V
Current for LED backlight	I <sub>I</sub>	-	40	60	mA
LED Life Time	-	30000	50000	-	Hrs

**Note:** The LED Supply Voltage is defined by the numbers of LED at Ta=25°C and I<sub>L</sub>= 40mA.

## 7 ELECTRO-OPTICAL CHARACTERISTICS

ITEM	SYMBOL	CONDITION	MIN	TYP	MAX	UNIT	REMARK	NOTE
Response Time	Tr+Tf	θ=0° φ=0° Ta=25	-	20	30	ms	Figure 4	4
Contrast Ratio	Cr		320	400	-	---	Figure 5	1
Luminance Uniformity	δ WHITE		80	-	-	%	Figure 5	3
Surface Luminance	TFT		440	550	-	cd/m <sup>2</sup>	Figure 5	2
	TFT+CTP	400	500	-				
	TFT+RTP	350	440	-				
Viewing Angle Range	θ	φ = 90°	35	50	-	deg	Figure 6	6
		φ = 270°	55	70	-	deg	Figure 6	
		φ = 0°	55	70	-	deg	Figure 6	
		φ = 180°	55	70	-	deg	Figure 6	
CIE (x, y) Chromaticity	Red	θ=0° φ=0° Ta=25	x	0.570	0.620	0.670	Figure 6	5
			y	0.294	0.344	0.394		
	Green		x	0.256	0.306	0.356		
			y	0.513	0.563	0.613		
	Blue		x	0.083	0.133	0.183		
			y	0.099	0.149	0.199		
	White		x	0.250	0.300	0.350		
			y	0.280	0.330	0.380		

**Note 1.** Contrast Ratio(CR) is defined mathematically as below, for more information see Figure.

$$\text{Contrast Ratio} = \frac{\text{Average Surface Luminance with all white pixels (P1, P2, P3, P4, P5)}}{\text{Average Surface Luminance with all black pixels (P1, P2, P3, P4, P5)}}$$

**Note 2.** Surface luminance is the LCD surface from the surface with all pixels displaying white. For more information, see Figure.

$L_v$  = Average Surface Luminance with all white pixels (P1, P2, P3, P4, P5)

**Note 3.** The uniformity in surface luminance  $\delta$  WHITE is determined by measuring luminance at each test position 1 through 5, and then dividing the maximum luminance of 5 points luminance by minimum luminance of 5 points luminance. For more information, see Figure.

$$\delta \text{ WHITE} = \frac{\text{Minimum Surface Luminance with all white pixels (P1, P2, P3, P4, P5)}}{\text{Maximum Surface Luminance with all white pixels (P1, P2, P3, P4, P5)}}$$

**Note 4.** Response time is the time required for the display to transition from white to black (Rise Time,  $T_r$ ) and from black to white (Decay Time,  $T_f$ ). For additional information see FIG 1. The test equipment is Autronic-Melchers's ConoScope series.

**Note 5.** CIE (x, y) chromaticity, the x, y value is determined by measuring luminance at each test position 1 through 5, and then make average value.

**Note 6.** Viewing angle is the angle at which the contrast ratio is greater than 2. For TFT module the contrast ratio is greater than 10. The angles are determined for the horizontal or x axis and the vertical or y axis with respect to the z axis which is normal to the LCD surface. For more information see Figure.

**Note 7.** For viewing angle and response time testing, the testing data is based on Autronic-Melchers's ConoScope series. Instruments for Contrast Ratio, Surface Luminance, Luminance Uniformity, CIE the test data is based on TOPCON's BM-5 photo detector.

**Note 8.** For TFT module, Gray scale reverse occurs in the direction of panel viewing angle.

Figure 4. The definition of response time

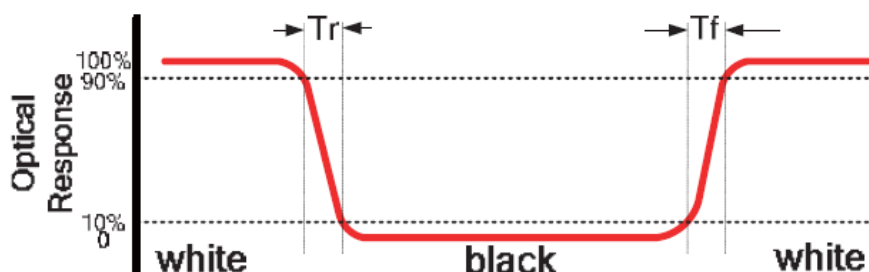

Figure 5. Measuring method for Contrast ratio, surface luminance, Luminance uniformity, CIE (x, y) chromaticity

A : 5 mm  
 B : 5 mm  
 H, V : Active Area  
 Light spot size  $\varnothing=5\text{mm}$ , 500mm distance from the LCD surface to detector lens  
 measurement instrument is TOPCON's luminance meter BM-5

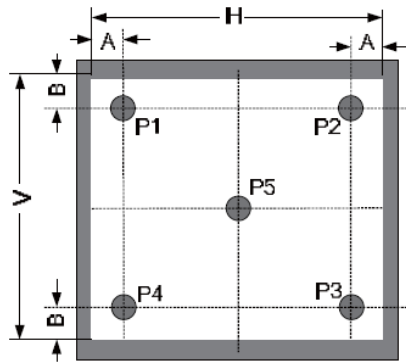
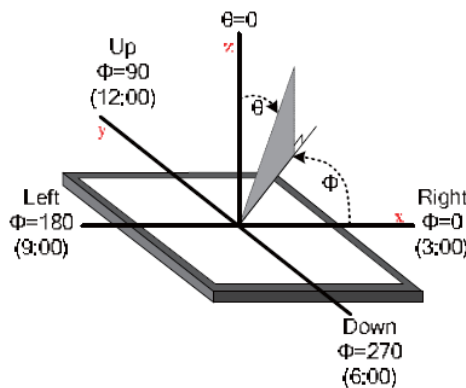

Figure 6. The definition of viewing angle



## 8 INTERFACE DESCRIPTION

PIN NO.	SYMBOL	DESCRIPTION
1	VDD	Power Supply
2	GND	Ground
3	SPI_SCLK	SPI SCK Signal, Internally 47k Pull UP
4	MISO/ IO1	SPI MISO Signal / SPI Quad mode: SPI data line 1
5	MOSI/ IO0	SPI MOSI Signal / SPI Quad mode: SPI data line 0
6	CS	SPI Chip Select Signal , Internally 47k Pull UP
7	INT	Interrupt Signal, Active Low, Internally 47k Pull UP
8	PD	Power Down Signal, Active Low, Internally 47k Pull UP
9	NC	Not Connected
10	AUDIO_OUT	Audio Out Signal
11	GPIO0/IO2	SPI Single mode: General purpose IO0/ SPI Quad mode: SPI data line 2
12	GPIO1/IO3	SPI Single mode: General purpose IO1/ SPI Quad mode: SPI data line 3
13	GPIO2	General purpose IO2
14	GPIO3	General purpose IO3 or analog input for ADC
15	NC	Not Connected
16	NC	Not Connected
17	BLVDD	Backlight Power Supply, Can Be Connected to VDD
18	BLVDD	Backlight Power Supply, Can Be Connected to VDD
19	BLGND	Backlight Ground, Internally connected to GND
20	BLGND	Backlight Ground, Internally connected to GND



## 9 BT8x CONTROLLER SPECIFICATIONS

BT8x or EVE3 (Embedded Video Engine 3) simplifies the system architecture for advanced human machine interfaces (HMIs) by providing functionality for display, audio, and touch as well as an object oriented architecture approach that extends from display creation to the rendering of the graphics.

### 9.1 Serial host interface

Figure 7. SPI interface connection

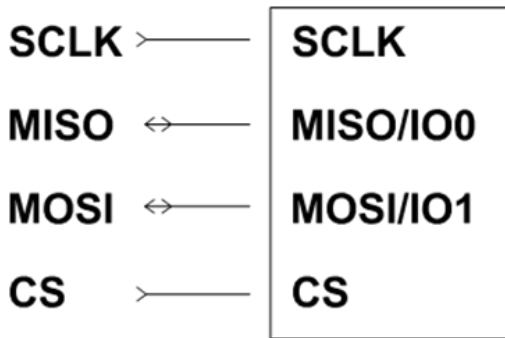
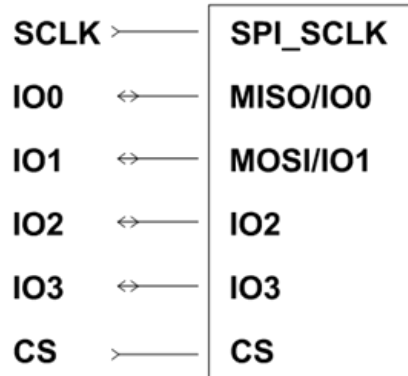

Figure 8. QSPI interface connection



**SPI Interface** – the SPI slave interface operates up to 30MHz.

Only SPI mode 0 is supported. The SPI interface is selected by default (MODE pin is internally pulled low by 47k resistor).

### 9.2 Block Diagram

Figure 9. BT8x Block diagram

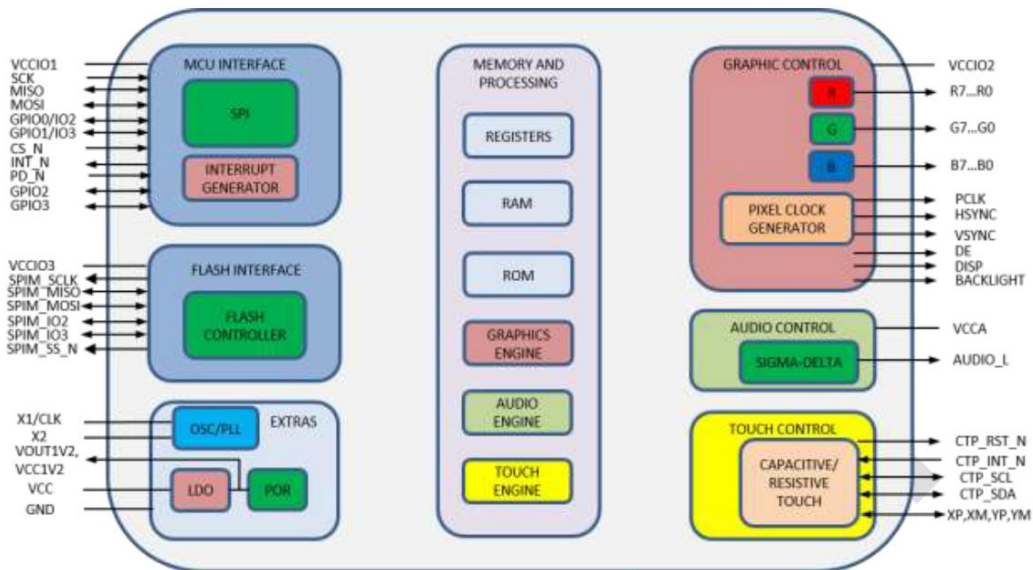

9.3 Host interface SPI mode 0

Figure 10. SPI timing diagram

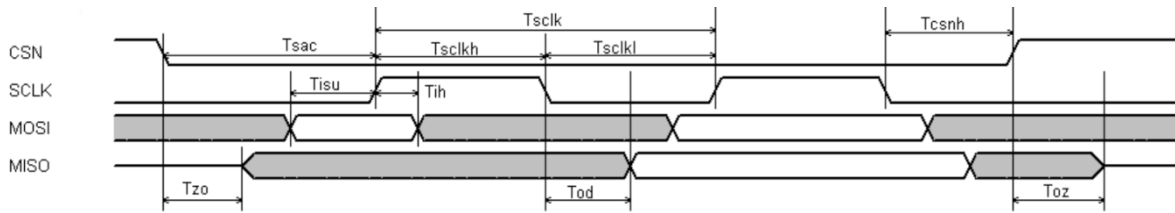

For more information about BT8x controller please go to official BT8x website.

<https://www.ftdichip.com/Products/ICs/BT81X.html>

9.4 Backlight driver block diagram

Backlight enable signal is internally connected to BT8x Backlight control pin. This pin is controlled by two BT8x’s registers. One of them specifies the PWM output frequency, second one specifies the duty cycle. Refer to BT8x datasheet for more information.

Figure 11. Backlight driver block diagram

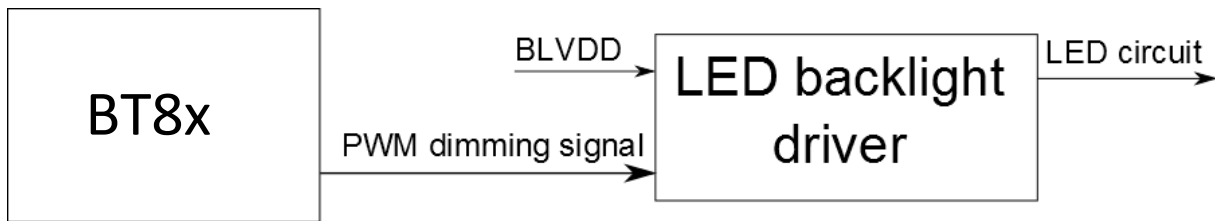

10 LCD TIMING CHARACTERISTICS

10.1 Clock and data input time diagram

Figure 12. Clock and data input time diagram.

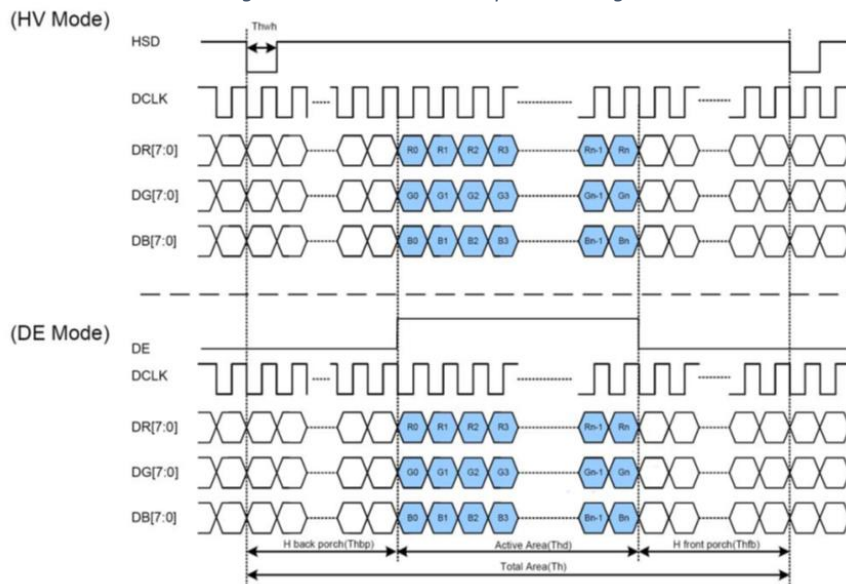

## 10.2 Parallel RGB timing table

PARAMETER	SYMBOL	MIN	TYP	MAX	UNIT
DCLK Frequency	Fclk	5	9	12	MZH
VSD Period Time	Tv	277	288	400	H
VSD Display Area	Tvd	272			H
VSD Back Porch	Tvb	3	8	31	H
VSD Front Porch	Tvfp	2	8	97	H
HSD Period Time	Th	520	525	800	DCLK
HSD Display Area	Thd	480			DCLK
HSD Back Porch	Thbp	36	40	255	DCLK
HSD Front Porch	Thfp	4	5	65	DCLK

## 11 TOUCH SCREEN PANEL SPECIFICATIONS

## 11.1 Electrical characteristics

**Note:** Avoid operating with hard or sharp material such as a ball point pen or a mechanical pencil except a polyacetal pen (tip R0.8mm or less) or a finger

## 11.1.1 For capacitive touch panel

DESCRIPTION	SPECIFICATION
Operating Voltage	DC 2.8~3.3V
Power Consumption (IDD)	Active Mode
	Sleep Mode
Interface	I <sup>2</sup> C
Linearity	<1.5%
Controller	FT5446
I2C address	0x38 (7-bit address)
Resolution	1280*768

## 11.1.2 For resistive touch panel

ITEM	VALUE			UNIT	REMARK
	Min.	Typ.	Max.		
Linearity	-3.0	-	3.0	%	Analog X and Y directions
Terminal Resistance	400	-	1050	Ω	X
	100	-	450	Ω	Y
Insulation Resistance	-	-	-	MΩ	DC 25V
Voltage	-	-	10	V	DC
Chattering	-	-	10	ms	100kΩ pull-up
Transparency	80	-	-	%	JIS K7105

### 11.2 Mechanical characteristics

**Note 1: Force test condition,** Input DC 5V on X direction, Drop off Polyacetal Stylus (R0.8), until output voltage stabilize, then get the R8.0mm Silicon rubber and do finger Activation force test. Next step, 9 points.

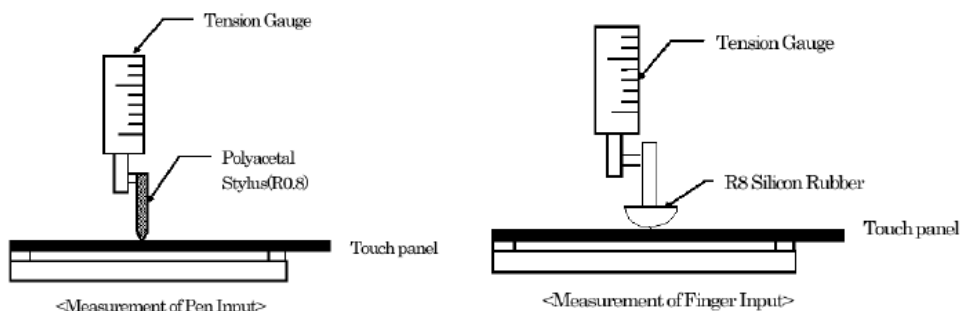

**Note 2: Measurement surface area conditions,** Scratch 100,000 times straight line on the film with a stylus change every 20,000 times with Force: 250gf, Speed: 60mm/sec by R0.8 polaceteal stylus.

**Note 3: Pitting test,** Pit 1, 000, 000 times on the film with R0.8 silicon rubber with Force: 250gf and Speed: 2 times/sec.

#### 11.2.1 For capacitive touch panel

DESCRIPTION	INL SPECIFICATION	REMARK
Touch Panel Size	4.3 inch	
Outline Dimension (OD)	103.1mm x 65.4mm	Cover Lens Outline
Outline Dimension (OD) -UxTouch	120.38mm x 79.20mm	
Product Thickness	1.7mm	
Glass Thickness	0.7mm	
Ink View Area	97.0mm x 55.5mm	
Sensor Active Area	97.4mm x 56.4mm	
Input Method	5 Finger	
Activation Force	Touch	
Surface Hardness	≥7H	

#### 11.2.2 For resistive touch panel

**Note 1: Force test condition,** Input DC 5V on X direction, drop off Polyacetal Stylus (R0.8), until output voltage stabilize, then get the R8.0mm Silicon rubber and do finger Activation force test. Next step, 9 points.

ITEM	VALUE			UNIT	REMARK
	Min.	Typ.	Max.		
Activation Force	80	-	-	gf	Note 1
Durability-Surface Scratching	Write 100,000	-	-	characters	Note 2
Durability-Surface Pitting	1,000,000	-	-	touches	Note 3
Surface Hardness	3	-	-	H	JIS K5400

## 12 INSPECTION

Standard acceptance/rejection criteria for TFT module.

### 12.1 Inspection condition

*Ambient conditions:*

- Temperature:  $25\pm^{\circ}\text{C}$
- Humidity:  $(60\pm 10)\% \text{RH}$
- Illumination: Single fluorescent lamp non-directive (300 to 700 lux)

*Viewing distance:*

$35\pm 5\text{cm}$  between inspector bare eye and LCD.

*Viewing Angle:*

U/D:  $45^{\circ}/45^{\circ}$ , L/R  $45^{\circ}/45^{\circ}$

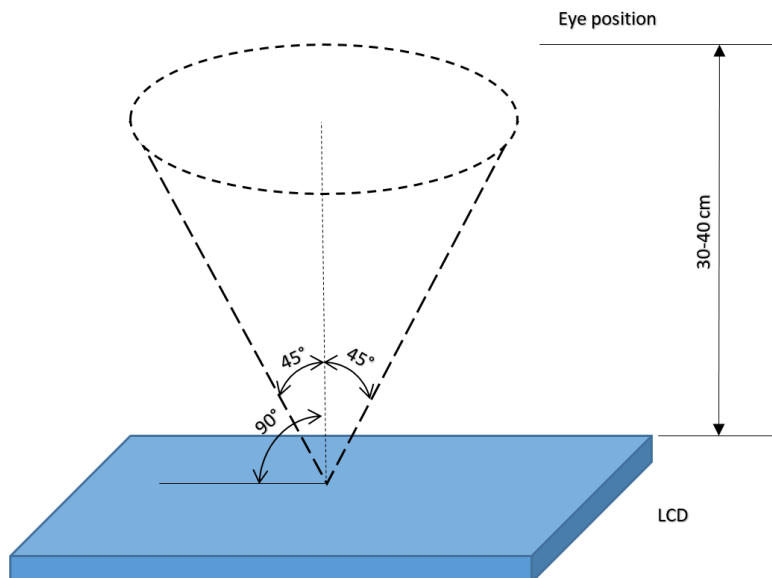

12.2 Inspection standard

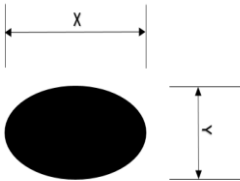
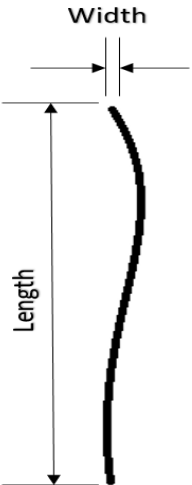
Item	Criterion																																		
<p><b>Black spots, white spots, light leakage, Foreign Particle (round Type)</b></p>	<div style="display: flex; align-items: center; justify-content: center;">  <table border="1" style="margin-left: 20px;"> <thead> <tr> <th colspan="2">Size &lt; 5"</th> </tr> <tr> <th>Average Diameter</th> <th>Qualified Qty</th> </tr> </thead> <tbody> <tr> <td>D &lt; 0.2 mm</td> <td>Ignored</td> </tr> <tr> <td>0.2 mm &lt; D &lt; 0.3 mm</td> <td>3</td> </tr> <tr> <td>0.3 mm &lt; D &lt; 0.5 mm</td> <td>2</td> </tr> <tr> <td>0.5 mm &lt; D</td> <td>0</td> </tr> </tbody> </table> </div> <div style="text-align: center; margin: 10px 0;"> <math display="block">D = \frac{(x + y)}{2}</math> </div> <p>*Spots density: 10 mm</p>	Size < 5"		Average Diameter	Qualified Qty	D < 0.2 mm	Ignored	0.2 mm < D < 0.3 mm	3	0.3 mm < D < 0.5 mm	2	0.5 mm < D	0																						
Size < 5"																																			
Average Diameter	Qualified Qty																																		
D < 0.2 mm	Ignored																																		
0.2 mm < D < 0.3 mm	3																																		
0.3 mm < D < 0.5 mm	2																																		
0.5 mm < D	0																																		
<p><b>LCD black spots, white spots, light leakage (line Type)</b></p>	<div style="display: flex; align-items: center; justify-content: center;">  <table border="1" style="margin-left: 20px;"> <thead> <tr> <th colspan="3">Size &lt; 5"</th> </tr> <tr> <th>Length</th> <th>Width</th> <th>Qualified Qty</th> </tr> </thead> <tbody> <tr> <td>-</td> <td>W &lt; 0.02</td> <td>Ignored</td> </tr> <tr> <td>L &lt; 3.0</td> <td>0.02 &lt; W &lt; 0.05</td> <td rowspan="2">2</td> </tr> <tr> <td>L &lt; 2.5</td> <td>0.05 &lt; W &lt; 0.08</td> </tr> <tr> <td>-</td> <td>0.08 &lt; W</td> <td>0</td> </tr> </tbody> </table> </div> <div style="margin-top: 20px;"> <table border="1"> <thead> <tr> <th colspan="3">Size &gt;= 5"</th> </tr> <tr> <th>Length</th> <th>Width</th> <th>Qualified Qty</th> </tr> </thead> <tbody> <tr> <td>-</td> <td>W &lt; 0.02</td> <td>Ignored</td> </tr> <tr> <td>L &lt; 3.0</td> <td>0.02 &lt; W &lt; 0.05</td> <td rowspan="2">4</td> </tr> <tr> <td>L &lt; 2.5</td> <td>0.05 &lt; W &lt; 0.08</td> </tr> <tr> <td>-</td> <td>0.08 &lt; W</td> <td>0</td> </tr> </tbody> </table> </div> <p>*Spots density: 10 mm</p>	Size < 5"			Length	Width	Qualified Qty	-	W < 0.02	Ignored	L < 3.0	0.02 < W < 0.05	2	L < 2.5	0.05 < W < 0.08	-	0.08 < W	0	Size >= 5"			Length	Width	Qualified Qty	-	W < 0.02	Ignored	L < 3.0	0.02 < W < 0.05	4	L < 2.5	0.05 < W < 0.08	-	0.08 < W	0
Size < 5"																																			
Length	Width	Qualified Qty																																	
-	W < 0.02	Ignored																																	
L < 3.0	0.02 < W < 0.05	2																																	
L < 2.5	0.05 < W < 0.08																																		
-	0.08 < W	0																																	
Size >= 5"																																			
Length	Width	Qualified Qty																																	
-	W < 0.02	Ignored																																	
L < 3.0	0.02 < W < 0.05	4																																	
L < 2.5	0.05 < W < 0.08																																		
-	0.08 < W	0																																	



Item	Criterion	
Clear spots	Size < 5"	
	<b>Average Diameter</b>	Qualified Qty
	<b>D &lt; 0.2 mm</b>	Ignored
	<b>0.2 mm &lt; D &lt; 0.3 mm</b>	3
	<b>0.3 mm &lt; D &lt; 0.5 mm</b>	2
	<b>0.5 mm &lt; D</b>	0
	Size >= 5"	
	<b>Average Diameter</b>	Qualified Qty
	<b>D&lt;0.2 mm</b>	Ignored
	<b>0.2 mm &lt; D &lt; 0.3 mm</b>	4
	<b>0.3 mm &lt; D &lt; 0.5 mm</b>	2
	<b>0.5 mm &lt; D</b>	0
	*Spots density: 10 mm	
	Polarizer bubbles	Size < 5"
<b>Average Diameter</b>		Qualified Qty
<b>D &lt; 0.2 mm</b>		Ignored
<b>0.2 mm &lt; D &lt; 0.5 mm</b>		3
<b>0.5 mm &lt; D &lt; 1 mm</b>		2
<b>1 mm &lt; D</b>		0
<b>Total Q'ty</b>		3
Size >= 5"		
<b>Average Diameter</b>		Qualified Qty
<b>D&lt;0.25 mm</b>		Ignored
<b>0.25 mm &lt; D &lt; 0.5 mm</b>		3
<b>0.5 mm &lt; D</b>		0
Electrical Dot Defect		Size < 5"
		<b>item</b>
	<b>Black do defect</b>	4
	<b>Bright dot defect</b>	2
	<b>Total Dot</b>	5
	Size >= 5"	
	<b>item</b>	Qualified Qty
	<b>Black do defect</b>	5
	<b>Bright dot defect</b>	2
	<b>Total Dot</b>	5



Item	Criterion		
Touch panel spot	Size < 5"		
	<b>Average Diameter</b>	Qualified Qty	
	<b>D &lt; 0.2 mm</b>	Ignored	
	<b>0.2 mm &lt; D &lt; 0.4 mm</b>	5	
	<b>0.4 mm &lt; D &lt; 0.5 mm</b>	2	
	<b>0.5 mm &lt; D</b>	0	
	Size >= 5"		
	<b>Average Diameter</b>	Qualified Qty	
	<b>D&lt;0.25 mm</b>	Ignored	
	<b>0.25 mm &lt; D &lt; 0.5 mm</b>	4	
<b>0.5 mm &lt; D</b>	0		
Touch panel White Line Scratch	Size < 5"		
	<b>Length</b>	<b>Width</b>	Qualified Qty
	-	W< 0.02	Ignored
	<b>L &lt; 3.0</b>	0.02 < W <0.05	2
	<b>L &lt; 2.5</b>	0.05 < W <0.08	
	-	0.08 < W	0
	Size >= 5"		
	<b>Length</b>	<b>Width</b>	Qualified Qty
	-	W< 0.03	Ignored
	<b>L &lt; 5.0</b>	0.03 < W <0.05	2
-	0.05 < W	0	



## 13 RELIABILITY TEST

NO.	TEST ITEM	TEST CONDITION	REMARKS
1	High Temperature Storage	80±2°C/240hours	Note 2
2	Low Temperature Storage	-30±2°C/240hours	Note 1,2
3	High Temperature Operating	70±2°C/240hours	
4	Low Temperature Operating	-20±2°C/240hours	Note 1
5	Temperature Cycle	-30±2°C~25±2°C ~80±2°C × 20 cycles (30min.) (5min.) (30min.)	Note 1,2
6	Damp Proof Test	60°C ±5°C × 90%RH/240hours	
7	Vibration Test	Frequency 10Hz~55Hz Amplitude of vibration : 1.5mm Sweep time: 12 min X, Y, Z 2 hours for each direction.	
8	Package Drop Test	Height:60 cm 1 corner, 3 edges, 6 surfaces	
9	ESD Test	Air: ±4KV 150pF/330Ω 5 times Contact: ±2KV 150pF/330Ω 5 times	
10	ESD Test for RTP	Air: ±8KV 150pF/330Ω 5 times Contact: ±4KV 150pF/330Ω 5 times	

**Note 1:** Without water condensation.

**Note 2:** The function test shall be conducted after 2 hours storage at the room temperature and humidity after removed from the test chamber.

## 14 LEGAL INFORMATION

Riverdi makes no warranty, either expressed or implied with respect to any product, and specifically disclaims all other warranties, including, without limitation, warranties for merchantability, non-infringement and fitness for any particular purpose. Information about device are the property of Riverdi and may be the subject of patents pending or granted. It is not allowed to copy or disclosed this document without prior written permission.

Riverdi endeavors to ensure that the all contained information in this document are correct but does not accept liability for any error or omission. Riverdi products are in developing process and published information may be not up to date. Riverdi reserves the right to update and makes changes to Specifications or written material without prior notice at any time. It is important to check the current position with Riverdi.

Images and graphics used in this document are only for illustrative the purpose. All images and graphics are possible to be displayed on the range products of Riverdi, however the quality may vary. Riverdi is no liable to the buyer or to any third part for any indirect, incidental, special, consequential, punitive or exemplary damages (including without limitation lost profits, lost savings, or loss of business opportunity) relating to any product, service provided or to be provided by Riverdi, or the use or inability to use the same, even if Riverdi has been advised of the possibility of such damages.

Riverdi products are not fault tolerant nor designed, manufactured or intended for use or resale as on line control equipment in hazardous environments requiring fail – safe performance, such as in the operation of nuclear facilities, aircraft navigation or communication systems, air traffic control, direct life support machines or weapons systems in which the failure of the product could lead directly to death, personal injury or severe physical or environmental damage ('High Risk Activities'). Riverdi and its suppliers specifically disclaim any expressed or implied warranty of fitness for High Risk Activities. Using Riverdi products and devices in 'High Risk Activities' and in any other application is entirely at the buyer's risk, and the buyer agrees to defend, indemnify and hold harmless Riverdi from any and all damages, claims or expenses resulting from such use. No licenses are conveyed, implicitly or otherwise, under any Riverdi intellectual property rights.



## X-ON Electronics

Largest Supplier of Electrical and Electronic Components

*Click to view similar products for [TFT Displays & Accessories](#) category:*

*Click to view products by [Riverdi](#) manufacturer:*

Other Similar products are found below :

[F3ET2-005-150](#) [HDA430T-3G1H](#) [NB7W-KBA04](#) [NB-ATT01](#) [NB5Q-ATT01](#) [NB5Q-KBA04](#) [NB-CN001](#) [OAI-80038AA-2008-A](#) [315-U004B15300](#) [TCG121WXLRXVNNANX35](#) [EIC-LCD-1080P](#) [T-55619GD065J-LW-ABN](#) [NLB150XG02L-01](#) [NL192108AC10-01D](#) [NL6448AC18-08F](#) [NL8060BC26-35BA](#) [NL6448BC26-26D](#) [NL8060BC31-50F](#) [TM070DDHG03-40](#) [PTPW16-070WV1S02](#) [PTPW16-084SV1S02](#) [MTD0300ECP06DF-1](#) [4DLCD-35480320-CTP-IPS](#) [4DLCD-35480320-IPS](#) [4DLCD-35480320-RTP-IPS](#) [4DLCD-50800480-CTP-IPS](#) [RFA6400E-AWH-DNG](#) [RFE430V-AZW-DNS](#) [RFF70BQ-1IW-DBG](#) [RFF70VA2-1IW-DHS](#) [RFH700A8-AYH-MNN](#) [RFK101VF-1YH-LHG](#) [RFS52VA-1ZH-DHN](#) [SM-RVT101HVHFWN00](#) [SM-RVT101HVHNWC00](#) [SM-RVT101HVHNWCA0](#) [SM-RVT101HVHNWN00](#) [SM-RVT101HVLFWCA0](#) [SM-RVT101HVLNWCA0](#) [SM-RVT35HHTFWCA0](#) [SM-RVT35HHTNWCA0](#) [SM-RVT43HLTFWCA0](#) [SM-RVT43HLTNWCA0](#) [SM-RVT50HQTFWCA0](#) [SM-RVT50HQTNWCA0](#) [SM-RVT70AQLFWR00](#) [SM-RVT70AQLNWR00](#) [SM-RVT70HSLFWCA0](#) [SM-RVT70HSMFWCA0](#) [SM-RVT70HSMFWN00](#)