



RVT50HQBNWC00

EVE4 IPS 5.0" LCD TFT Datasheet

Rev.0.1

2020-12-29

ITEM	CONTENTS	UNIT
LCD Type	TFT/Transmissive/Normally black/IPS	/
Size	5.0	Inch
Viewing Direction	Free	/
Outside Dimensions (W × H × D)	136.00 × 92.80 × 11.73	mm
Active Area (W × H)	108.0 × 64.8	mm
Pixel Pitch (W × H)	0.135 × 0.135	mm
Resolution	800 × 480 (RGB)	/
Brightness	800	cd/m ²
Color Depth	16.7 M	/
Pixel Arrangement	RGB Vertical Stripe	/
Driver IC of Board	BT817Q	/
Interface	SPI/QSPI	/
Host Connector	RiBUS, ZIF 20 pin, 0.5mm pitch, down-side contact	/
With/Without Touch	With Projected Capacitive Touch Panel	/
CTP Driver	ILI2132A	/
Supply Voltage for Module	3.3	V
Supply Voltage for Backlight	5.0 (TYP.)	V
Weight	115	g

Note 1: RoHS compliant

Note 2: LCM weight tolerance: ± 5%.

REVISION RECORD

REV NO.	REV DATE	CONTENTS	REMARKS
0.1	2020-12-29	Preliminary	

CONTENTS

REVISION RECORD.....	2
CONTENTS	2
1 MODULE CLASSIFICATION INFORMATION	3
2 UxTOUCH ASSEMBLY	4
3 MODULE DRAWING.....	4
4 ABSOLUTE MAXIMUM RATINGS.....	6
5 ELECTRICAL CHARACTERISTICS.....	6
6 BACKLIGHT ELECTRICAL CHARACTERISTICS.....	6
7 ELECTRO-OPTICAL CHARACTERISTICS	7
8 INTERFACE DESCRIPTION	9
8.1 P1 connector- RIBUS description.....	9
8.2 P2 connector description	9
9 BT817Q CONTROLLER SPECIFICATION	10
9.1 Serial host interface.....	10
9.2 Block Diagram.....	11
9.3 Host interface SPI mode 0	11
9.4 Backlight driver block diagram	12
10 TIMING CHARACTERISTICS	13
10.1 RGB mode.....	13
10.2 System bus timing for RGB interface.....	13
10.2.1 SYNC Mode.....	13
10.2.2 SYNC-DE Mode	14
10.2.3 DE Mode	15
10.3 Parallel 24-bit RGB input timing table.....	15
11 CAPACITIVE TOUCH SCREEN PANEL SPECIFICATIONS	16
11.1 Mechanical characteristics	16
11.2 Electrical characteristics	16
12 INITIALIZATION CODE	16
13 INSPECTION	17
13.1 Inspection condition.....	17
13.2 Inspection standard.....	18
14 RELIABILITY TEST.....	20
15 LEGAL INFORMATION.....	21

1 MODULE CLASSIFICATION INFORMATION

RV	T	50	H	Q	B	N	W	C	00
1.	2.	3.	4.	5.	6.	7.	8.	9.	10.

1.	BRAND	RV – Riverdi
2.	PRODUCT TYPE	T – TFT Standard
3.	DISPLAY SIZE	50 – 5.0”
4.	MODEL SERIAL NO.	H – High Brightness, IPS
5.	RESOLUTION	Q – 800 x 480 px
6.	INTERFACE	B – SPI/QSPI
7.	FRAME	N – No Frame
8.	BACKLIGHT TYPE	W – LED White
9.	TOUCH PANEL	C – With Capacitive Touch Panel
10.	VERSION	00 – (00-99)

2 UxTOUCH ASSEMBLY

UxTouch are LCD TFT displays with specially designed projected capacitive touch panels. UxTouch display can be mounted without any additional holes in the housing. Our standard UxTouch displays include double-sided adhesive tape (DST) to stick TFT easily to the housing.

UxTouch models with double-side adhesive tape can be mounted by fastening the glass to the housing. Riverdi recommends to use support brackets assembled to display's back. An additional support will stiffen the whole structure and minimize the influence of external factors such as vibration. Figure 1 below show examples of using the support elements. If you can't add the supportive brackets, you may be interested in optically bonded version of this display RVT50HQBNWC00-B, which is superior in optical performance and does not require any extra support.

Figure 1. Example of using the support brackets



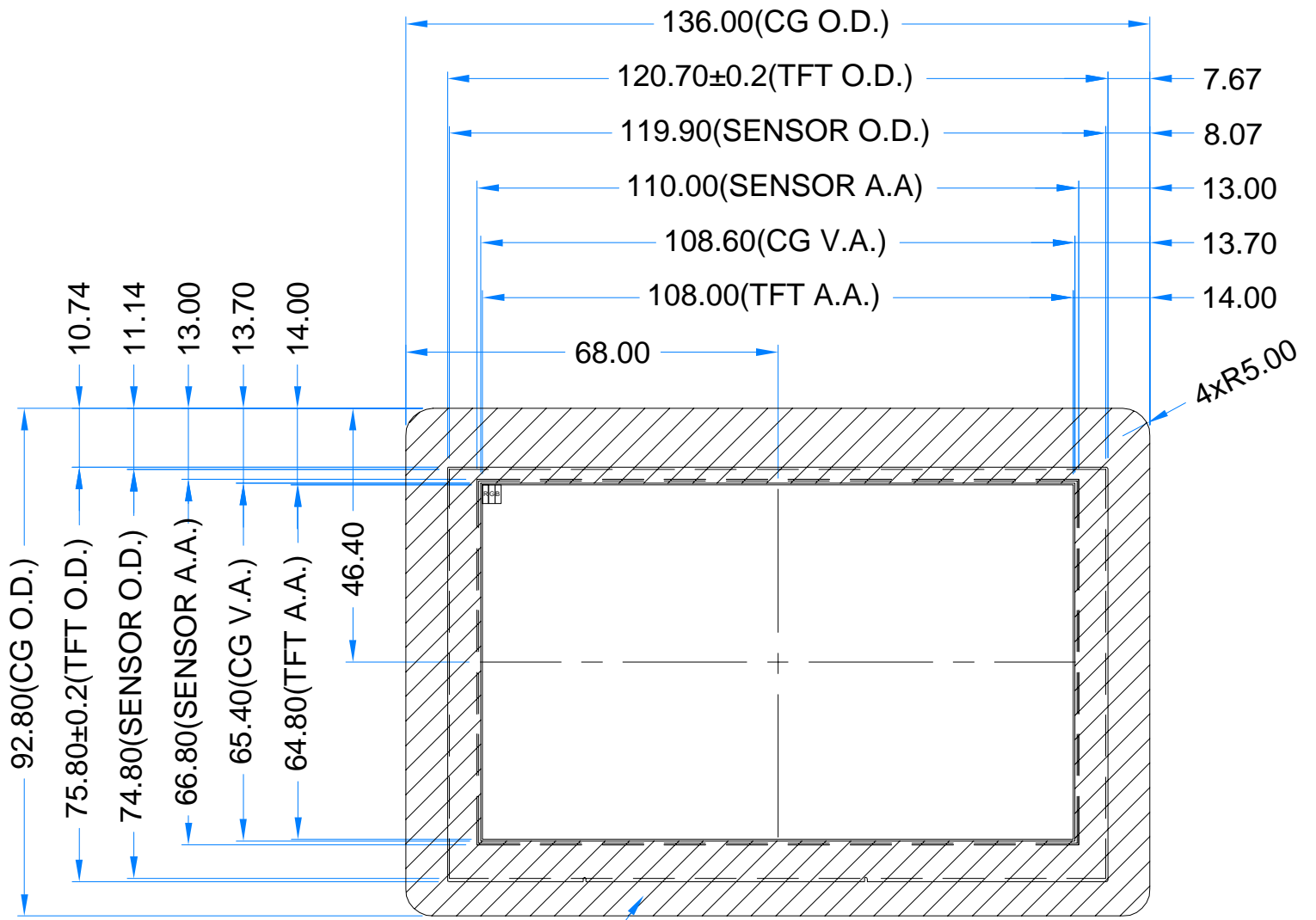

BLACK MASK PRINTING
RAL9005

DETAIL A
SCALE 4:1

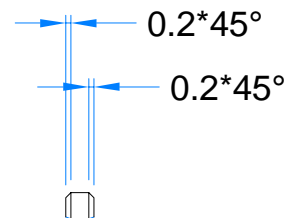

LCD NOTES:

1. LCD TYPE: TRANSMISSIVE, NORMALLY BLACK, IPS
2. RESOLUTION: 800x480
3. VIEWING ANGLE: FREE
4. SURFACE LUMINANCE: 800 cd/m²
5. DRIVING IC ON THE BOARD: BT817Q
6. INTERFACE: SPI/QSPI
7. SUPPLY VOLTAGE FOR MODULE: 3.3V
8. SUPPLY VOLTAGE FOR BACKLIGHT: 5.0V(TYP.), BUILT-IN LED INVERTER

TP NOTES:

1. TP STRUCTURE: G+G
2. CG THICKNESS: 1.10 mm
3. SURFACE HARDNESS: 7H
4. DRIVER IC: ILI2132A
5. INTERFACE: SPI/QSPI VIA RIBUS AND BT817Q

GENERAL NOTES:

1. OPERATING T...
2. STORAGE TE...
3. WITHOUT IND...
4. RoHS3 COMPI...

4 ABSOLUTE MAXIMUM RATINGS

PARAMETER	SYMBOL	MIN	MAX	UNIT	NOTE
Supply Voltage for Module	VDD	0	4	V	Note 1
Digital I/O signals (SPI/QSPI/GPIO) Voltage	VIN	-0.5	5.5	V	Note 1, 2
Supply voltage for Backlight	BLVDD	-0.3	6	V	Note 1
Operating Temperature	T _{OP}	-20	70	°C	
Storage Temperature	T _{ST}	-30	80	°C	
Storage Humidity (@ 25 ± 5°C)	H _{ST}	10	-	% RH	
Operating Ambient Humidity (@ 25 ± 5°C)	H _{OP}	10	-	% RH	

Note 1. Exceeding the maximum values may cause improper operation or permanent damage to the unit.

Note 2. Digital I/O signals are to be connected to pins 3 ÷ 9, 11 and 12 pins at RiBUS connector (P1).

5 ELECTRICAL CHARACTERISTICS

PARAMETER	SYMBOL	MIN	TYP	MAX	UNIT	NOTE
Supply Voltage for Module	VDD	3.0	3.3	3.6	V	
Current drawn from VDD	I _{VDD}	TBD	210	TBD	mA	Note 1
Input Voltage "H" Level	V _{IH}	2.0	TBD	3.3	V	Note 1
Input Voltage "L" Level	V _{IL}	0	TBD	0.8	V	Note 1

Note 1. These values will be announced after the samples have been tested.

6 BACKLIGHT ELECTRICAL CHARACTERISTICS

PARAMETER	SYMBOL	MIN	TYP	MAX	UNIT	NOTE
Supply Voltage for Backlight	BLVDD	TBD	5.0	6.0	V	
Current drawn from BLVDD @5.0V	I _{BLVDD=5.0V}	TBD	410	TBD	mA	100% of backlight, Note 1
Current drawn from BLVDD@5.0V	I _{BLVDD=5.0V}	TBD	180	TBD	mA	50% of backlight, Note 1
Life Time	-	-	50,000	-	hours	Note 2

Note 1. Backlight intensity is driven by BT817Q controller by PWM wave from GPIO pin. Please refer to subchapter 9.4.

Note 2. Operating life means the period of time in which the LED brightness goes down to 50% of the initial brightness. Typical operating life time is the estimated parameter.

7 ELECTRO-OPTICAL CHARACTERISTICS

ITEM	SYMBOL	CONDITION	MIN	TYP	MAX	UNIT	REMARK	NOTE
Response Time	Tr+Tf	$\theta=0^\circ$ $\phi=0^\circ$ $T_a=25^\circ\text{C}$	-	30	-	ms	FIG 2.	4
Contrast Ratio	Cr		-	1000	-	---	FIG 3.	1
Luminance Uniformity	δ WHITE		-	75	-	%	FIG 3.	3
Surface Luminance	Lv		756	800	-	cd/m ²	FIG 3.	2
Viewing Angle Range	θ	$\phi = 90^\circ$	-	80	-	deg	FIG 4.	6
		$\phi = 270^\circ$	-	80	-	deg	FIG 4.	
		$\phi = 0^\circ$	-	80	-	deg	FIG 4.	
		$\phi = 180^\circ$	-	80	-	deg	FIG 4.	
CIE (x, y) Chromaticity	Red	x	0.575	0.615	0.655	FIG 3.	5	
		y	0.296	0.336	0.376			
	Green	x	0.352	0.392	0.432			
		y	0.512	0.552	0.592			
	Blue	x	0.100	0.140	0.180			
		y	0.085	0.125	0.165			
	White	x	0.274	0.316	0.358			
		y	0.295	0.336	0.378			

Note 1. Contrast Ratio(CR) is defined mathematically as below, for more information see Figure 2.

$$\text{Contrast Ratio} = \frac{\text{Average Surface Luminance with all white pixels (P1, P2, P3, P4, P5)}}{\text{Average Surface Luminance with all black pixels (P1, P2, P3, P4, P5)}}$$

Note 2. Surface luminance is the LCD surface from the surface with all pixels displaying white. For more information see Figure 3.

$$L_v = \text{Average Surface Luminance with all white pixels (P1, P2, P3, P4, P5)}$$

Note 3. The uniformity in surface luminance δ WHITE is determined by measuring luminance at each test position 1 through 5, and then dividing the minimum luminance of 5 points luminance by maximum luminance of 5 points luminance. For more information see Figure 3.

$$\delta \text{ WHITE} = \frac{\text{Minimum Surface Luminance with all white pixels (P1, P2, P3, P4, P5)}}{\text{Maximum Surface Luminance with all white pixels (P1, P2, P3, P4, P5)}}$$

Note 4. Response time is the time required for the display to transition from white to black (Rise Time, Tr) and from black to white (Decay Time, Tf). For additional information see Figure 1. The test equipment is Autronic-Melchers's ConoScope series.

Note 5. CIE (x, y) chromaticity, the x, y value is determined by measuring luminance at each test position 1 through 5, and then make average value.

Note 6. Viewing angle is the angle at which the contrast ratio is greater than 2. For TFT module the contrast ratio is greater than 10. The angles are determined for the horizontal or x axis and the vertical or y axis with respect to the z axis which is normal to LCD surface. For more information see Figure 4.

Note 7. For viewing angle and response time testing, the testing data is based on Autronic-Melchers's ConoScope series. Instruments for Contrast Ratio, Surface Luminance, Luminance Uniformity, CIE the test data is based on TOPCON's BM-5 photo detector.

Figure 2. The definition of response time

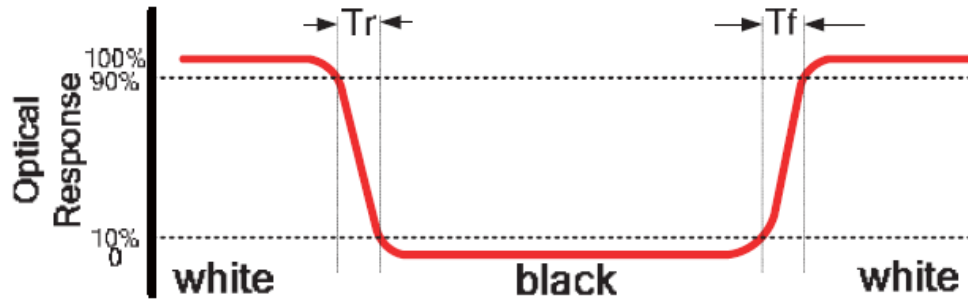
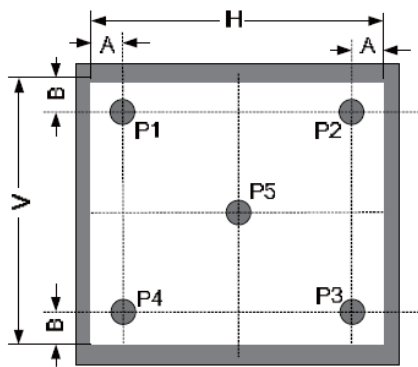

Figure 3. Measuring method for Contrast ratio, surface luminance, Luminance uniformity, CIE (x, y) chromaticity



A: 5mm

B: 5mm

H,V: Active Area

Light spot size $\phi=5\text{mm}$, 500mm distance from the LCD surface to detector lens.

Measurement instrument is TOPCON'S luminance meter BM-5

Figure 4. The definition of viewing angle

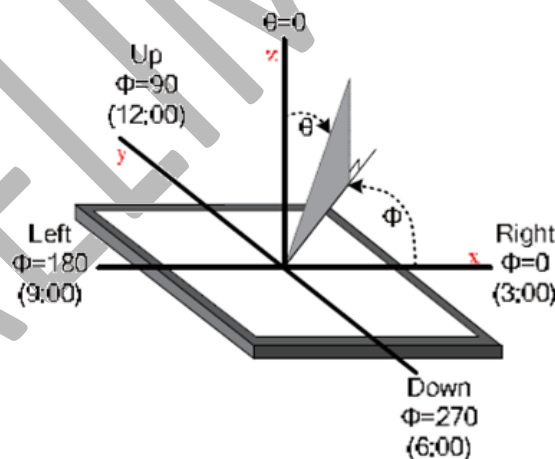

8 INTERFACE DESCRIPTION

8.1 P1 connector- RIBUS description

PIN NO.	SYMBOL	DESCRIPTION	NOTE
1	VDD	Supply voltage for module: 3.3 V	
2	GND	Ground	
3	SPI_SCLK	SPI SCK signal	
4	MISO/ IO.1	SPI MISO signal / SPI Quad mode: SPI data line 1	
5	MOSI/ IO.0	SPI MOSI signal / SPI Quad mode: SPI data line 0	
6	CS	SPI chip select signal	
7	INT	Interrupt signal from device to the system, Active Low, Internally 47k Pulled UP	
8	RST/PD	Reset / Power down signal, Active Low, Internally 47k Pulled UP	
9	GPIO.0	GPIO.0	
10	DISP_AUDIO	Display audio in/out	Note 1
11	GPIO.1/IO.2	SPI Single/Dual mode: General purpose IO0. QSPI mode: SPI data line 2	
12	GPIO.2/IO.3	SPI Single/Dual mode: General purpose IO1. QSPI mode: SPI data line 3	
13	NC	Not connected	
14	NC	Not connected	
15	NC	Not connected	
16	NC	Not connected	
17	BLVDD	Supply voltage for backlight	
18	BLVDD	Supply voltage for backlight	
19	BLGND	Backlight Ground, Internally connected to GND	
20	BLGND	Backlight Ground, Internally connected to GND	

Note 1. Requirements for audio external signal voltage will be announced after samples have been tested.

8.2 P2 connector description

PIN NO.	SYMBOL	DESCRIPTION	NOTE
1	SPEAKER +	Speaker coil "+" terminal	Note 1
2	SPEAKER -	Speaker coil "-" terminal	

The audio circuit allows for the following 3 things:

1. To play sounds from BT817Q on internal amplifier U3.
2. To play sounds from host on internal amplifier U3.
3. To play sounds from BT817Q on external amplifier.

Note 1. The loudspeaker assembly (loudspeaker + cables + plug compatible with P2 connector) will be sold separately. The documentation of the loudspeaker assembly will be released soon.

Figure 5. The simplified audio circuit design

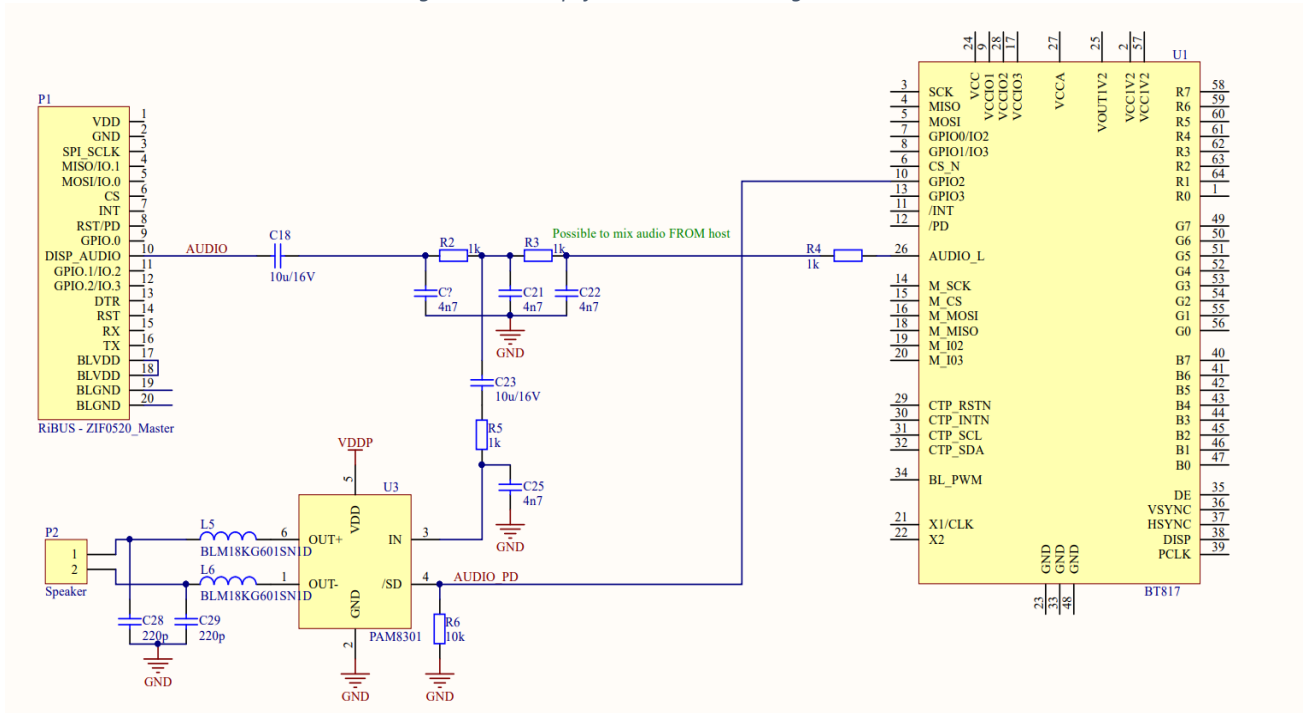

Note 2. By standard, the EVE4 board is equipped with the separate 512Mb flash memory chip, which allows to show up to 460 full resolution (800 * 480 pixels, JPG) images. If you need to change the memory size, please contact us: contact@riverdi.com

9 BT817Q CONTROLLER SPECIFICATION

BT817Q or EVE4 (Embedded Video Engine 4) simplifies the system architecture for advanced human machine interfaces (HMIs) by providing functionality for display, audio, and touch as well as an object oriented architecture approach that extends from display creation to the rendering of the graphics.

9.1 Serial host interface

Figure 6. SPI single/dual interface connection

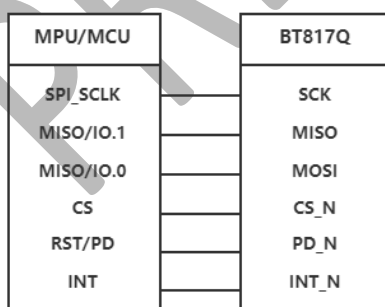
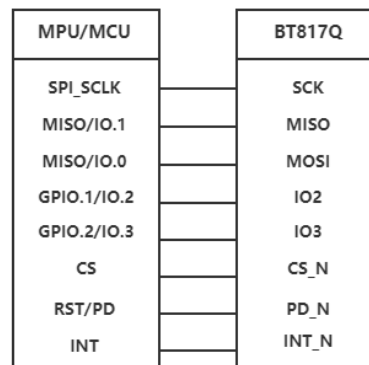

Figure 7. QSPI interface connection



SPI Interface – the SPI slave interface operates up to 30MHz (It depends on EVE4 system clock frequency and needs verification in Riverdi lab).

Only SPI mode 0 is supported. The SPI interface is selected by default (MODE pin is internally pulled low by 47k resistor).

QSPI Interface – the QSPI slave interface operates up to 30MHz (It depends on EVE 4 system clock frequency and will be verified in Riverdi lab). Only SPI mode 0 is supported. The QSPI can be configured as a SPI slave in SINGLE, DUAL or QUAD channel modes.

By default the SPI slave operates in the SINGLE channel mode with MOSI as input from the master and MISO as output to the master. DUAL and QUAD channel modes can be configured through the SPI slave itself. To change the channel modes, write to register REG_SPI_WIDTH.

9.2 Block Diagram

Figure 8. BT817Q Block diagram

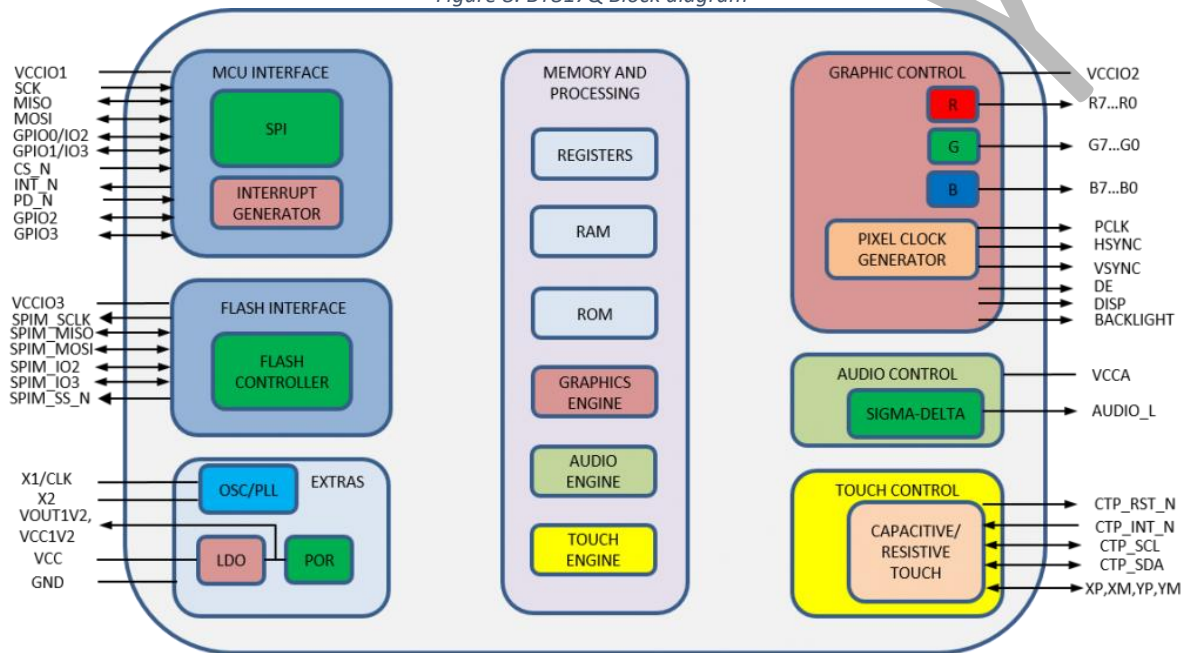

9.3 Host interface SPI mode 0

Figure 9. SPI timing diagram

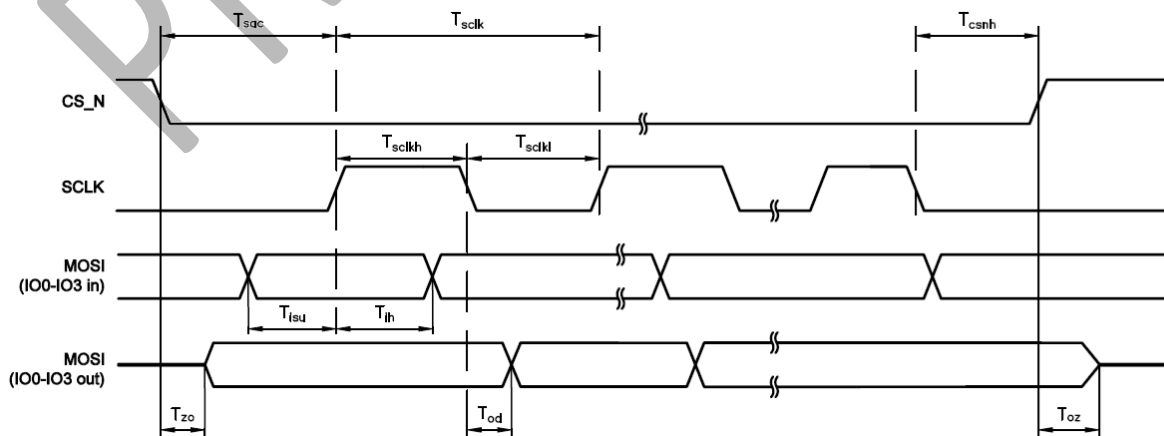

The meanings of the timings in the Figure 9 are defined in the table below.

PARAMETER	DESCRIPTION	VCCIO=1.8V		VCCIO=2.5V		VCCIO=3.3V		UNIT
		Min	Max	Min	Max	Min	Max	
T _{sclk}	SPI clock period	33.3		33.3		33.3		ns
T _{sckl}	SPI clock low duration	13		13		13		ns
T _{sckh}	SPI clock high duration	13		13		13		ns
T _{sac}	SPI access time	4		3.5		3		ns
T _{isu}	Input Setup	4		3.5		3		ns
T _{ih}	Input Hold	0		0		0		ns
T _{zo}	Output enable delay		16		13	11		ns
T _{oz}	Output disable delay		13		11	10		ns
T _{od}	Output data delay		15		12	11		ns
T _{csnh}	CSN hold time	0		0		0		ns

For more information about BT817Q controller please go to official BT81x website. <https://brtchip.com/bt81x/>

9.4 Backlight driver block diagram

Backlight enable signal is internally connected to BT817Q backlight control pin. This pin is controlled by two BT817Q's registers. One of them specifies the PWM output frequency, second one specifies the duty cycle. Refer to BT817Q datasheet for more information. After we have done the test on samples, more detailed description will be given in this document.

Figure 10. Backlight driver block diagram

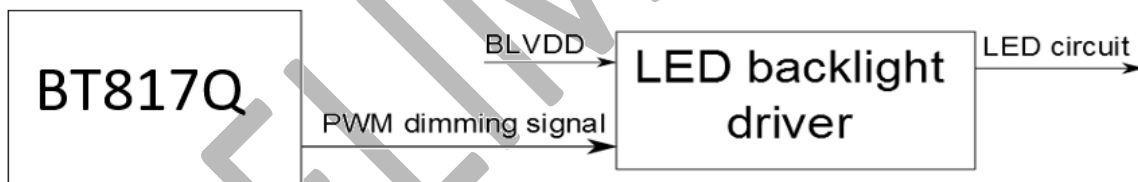

The LED backlight driver used in this module does not burst the LED current. Therefore, it does not generate audible noises on the output capacitor. It is equipped with soft start subsystem, which increases LED life time, as LED current peaks are reduced significantly.

10 TIMING CHARACTERISTICS

10.1 RGB mode

RGB MODE	DCLK	HSYNC	VSYNC	DE
SYNC-DE Mode	Input	Input	Input	Input

10.2 System bus timing for RGB interface

10.2.1 SYNC Mode

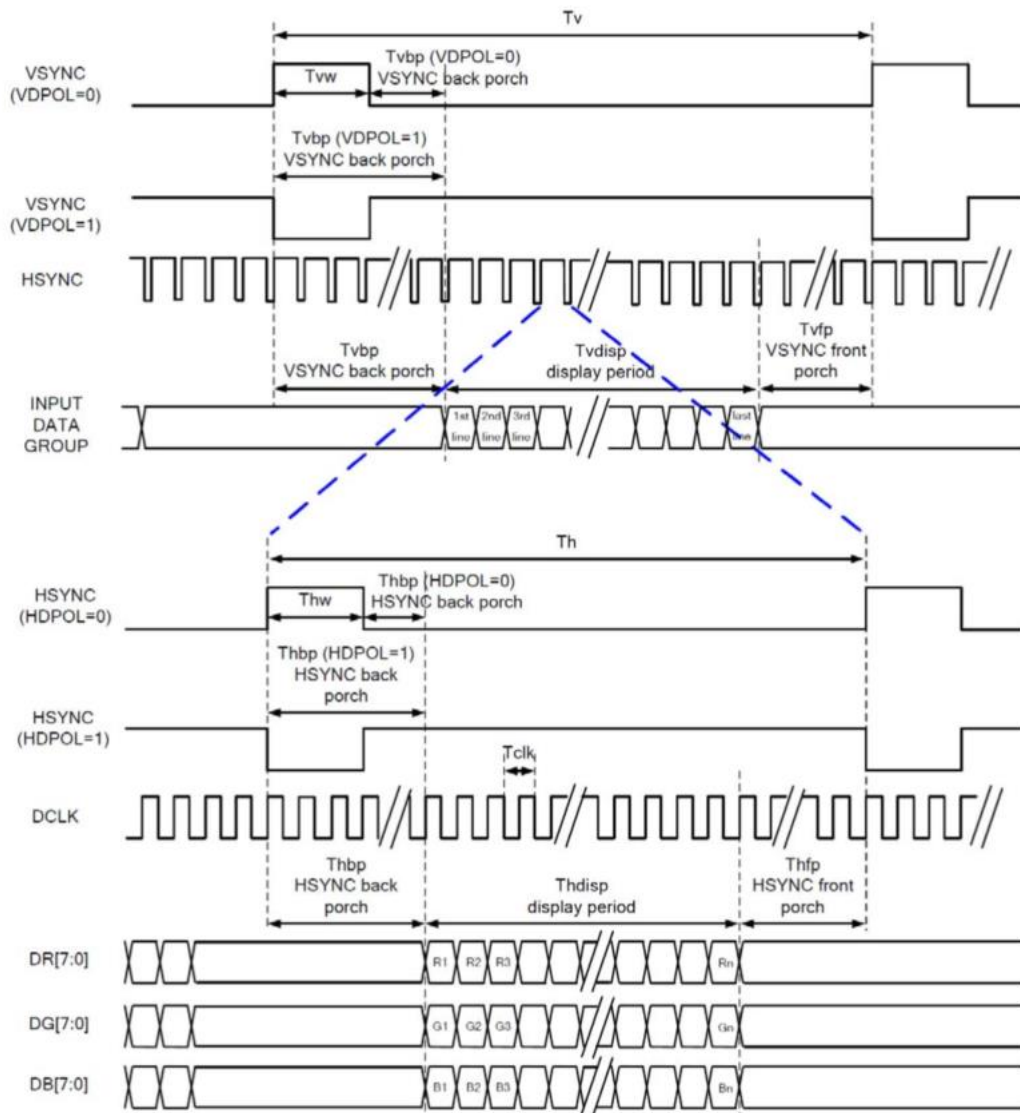

10.2.2 SYNC-DE Mode

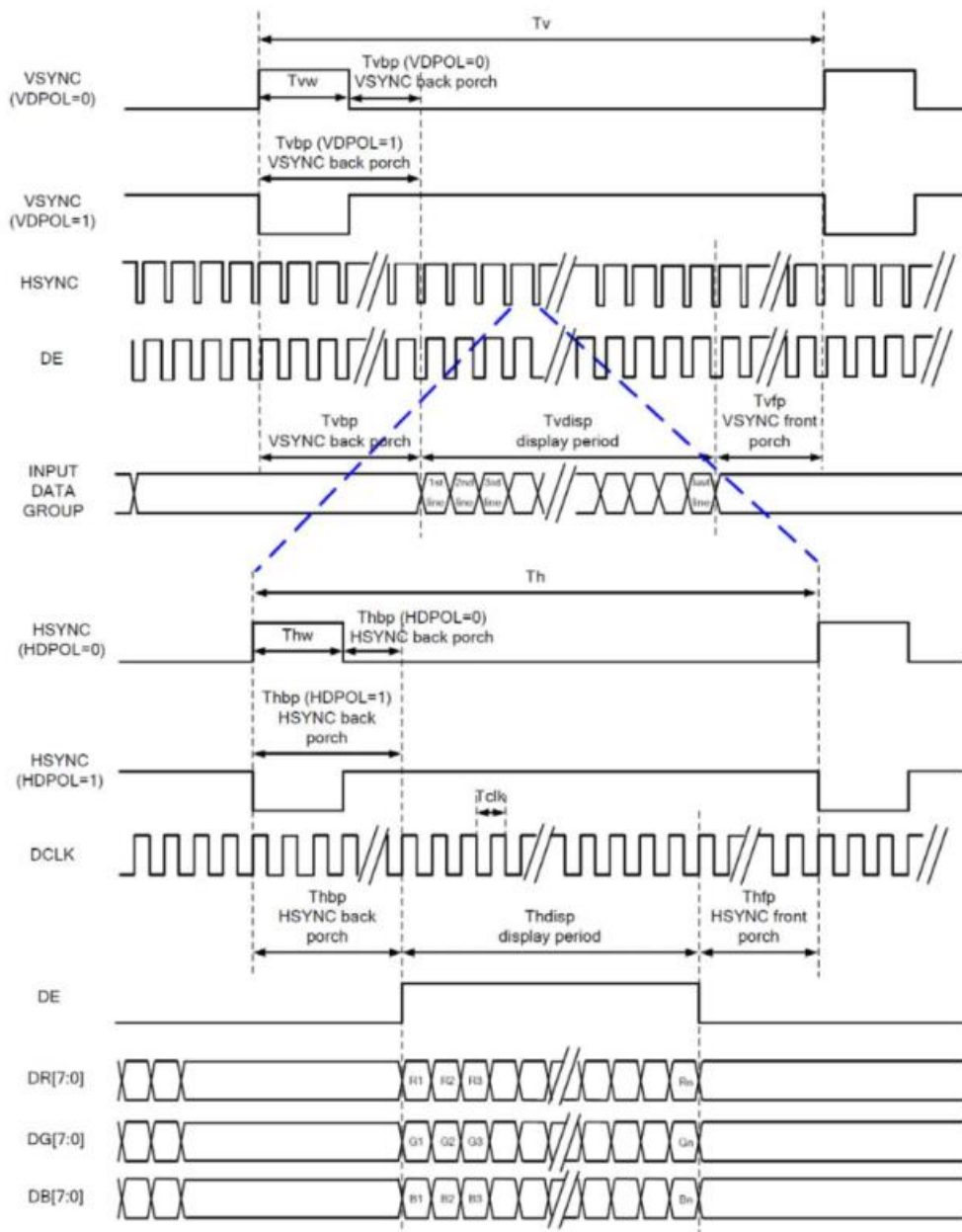

11 CAPACITIVE TOUCH SCREEN PANEL SPECIFICATIONS

11.1 Mechanical characteristics

DESCRIPTION	SPECIFICATION	REMARK
Touch Panel Size	5.0 inch	UxTouch
Outline Dimension of CTP	136.00 mm x 92.80 mm	UxTouch
Product Thickness	2.45 mm	UxTouch
Glass Thickness	1.1 mm	UxTouch
CTP View Area	108.60 mm x 65.40 mm	UxTouch
Sensor Active Area	110.00 mm x 66.80 mm	UxTouch
Structure type	Glass + Glass	UxTouch
Surface Hardness	7H	UxTouch

11.2 Electrical characteristics

DESCRIPTION	SPECIFICATION	NOTE
Power Consumption (IDD)	Active Mode	90 mA
	Sleep Mode	10 mA
Linearity	+/-1.5mm	
Controller	ILI2132A	
Resolution	800 x 480	

Note 1. These 2 values will be verified on the real samples.

12 INITIALIZATION CODE

This paragraph will be published in next versions of this datasheet.

13 INSPECTION

Standard acceptance/rejection criteria for TFT module.

13.1 Inspection condition

Ambient conditions:

- Temperature: 25 ± 2 °C
- Humidity: (60 ± 10) %RH
- Illumination: Single fluorescent lamp, non-directive (300 to 700 lux)

Viewing distance:

35 ± 5 cm between inspector bare eye and LCD.

Viewing Angle:

U/D: $45^\circ/45^\circ$, L/R: $45^\circ/45^\circ$

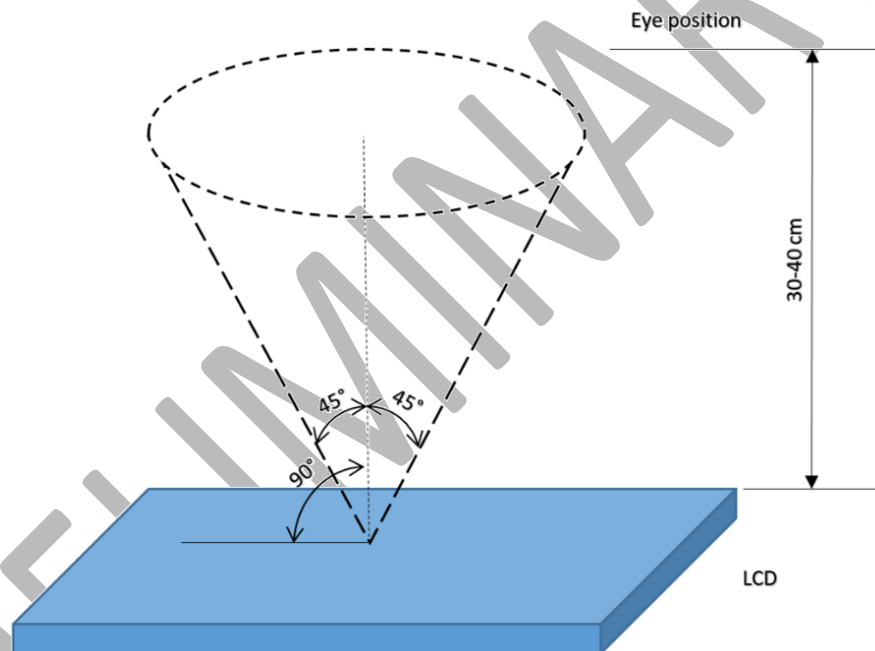

13.2 Inspection standard

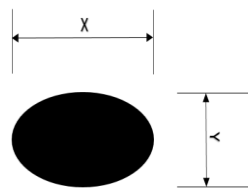
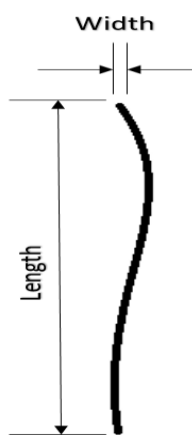
Item	Criterion																		
Black spots, white spots, light leakage, Foreign Particle (round Type)	 $D = \frac{(x + y)}{2}$ <p>*Spots density: 10 mm</p> <table border="1" style="margin-left: auto; margin-right: auto;"> <thead> <tr> <th colspan="2">3.5" ≤ Size ≤ 5"</th> </tr> <tr> <th>Average Diameter</th> <th>Qualified Qty</th> </tr> </thead> <tbody> <tr> <td>D ≤ 0.15 mm</td> <td>Ignored</td> </tr> <tr> <td>0.15 mm < D ≤ 0.30 mm</td> <td>N ≤ 3</td> </tr> <tr> <td>0.3mm < D</td> <td>Not allowed</td> </tr> </tbody> </table>	3.5" ≤ Size ≤ 5"		Average Diameter	Qualified Qty	D ≤ 0.15 mm	Ignored	0.15 mm < D ≤ 0.30 mm	N ≤ 3	0.3mm < D	Not allowed								
3.5" ≤ Size ≤ 5"																			
Average Diameter	Qualified Qty																		
D ≤ 0.15 mm	Ignored																		
0.15 mm < D ≤ 0.30 mm	N ≤ 3																		
0.3mm < D	Not allowed																		
LCD black spots, white spots, light leakage (line Type)	 <p>*Spots density: 10 mm</p> <table border="1" style="margin-left: auto; margin-right: auto;"> <thead> <tr> <th colspan="3">3.5" ≤ Size ≤ 5"</th> </tr> <tr> <th>Length/mm</th> <th>Width/mm</th> <th>Qualified Qty</th> </tr> </thead> <tbody> <tr> <td>-</td> <td>W ≤ 0.03</td> <td>Ignored</td> </tr> <tr> <td>L ≤ 3.0</td> <td>0.03 < W ≤ 0.05</td> <td>2</td> </tr> <tr> <td>L ≤ 3.0</td> <td>0.05 < W ≤ 0.1</td> <td>1</td> </tr> <tr> <td>3.0 < L</td> <td>0.1 < W</td> <td>Not allowed</td> </tr> </tbody> </table>	3.5" ≤ Size ≤ 5"			Length/mm	Width/mm	Qualified Qty	-	W ≤ 0.03	Ignored	L ≤ 3.0	0.03 < W ≤ 0.05	2	L ≤ 3.0	0.05 < W ≤ 0.1	1	3.0 < L	0.1 < W	Not allowed
3.5" ≤ Size ≤ 5"																			
Length/mm	Width/mm	Qualified Qty																	
-	W ≤ 0.03	Ignored																	
L ≤ 3.0	0.03 < W ≤ 0.05	2																	
L ≤ 3.0	0.05 < W ≤ 0.1	1																	
3.0 < L	0.1 < W	Not allowed																	
Bright/Dark Dots	<table border="1" style="margin-left: auto; margin-right: auto;"> <thead> <tr> <th colspan="2">3.5" ≤ Size ≤ 5"</th> </tr> <tr> <th>item</th> <th>Qualified Qty</th> </tr> </thead> <tbody> <tr> <td>Bright Dots</td> <td>N ≤ 1</td> </tr> <tr> <td>Dark Dots</td> <td>N ≤ 2</td> </tr> <tr> <td>Total Bright and Dark Dots</td> <td>N ≤ 3</td> </tr> </tbody> </table>	3.5" ≤ Size ≤ 5"		item	Qualified Qty	Bright Dots	N ≤ 1	Dark Dots	N ≤ 2	Total Bright and Dark Dots	N ≤ 3								
3.5" ≤ Size ≤ 5"																			
item	Qualified Qty																		
Bright Dots	N ≤ 1																		
Dark Dots	N ≤ 2																		
Total Bright and Dark Dots	N ≤ 3																		

Item	Criterion		
Clear spots	Size >= 5"		
	Average Diameter	Qualified Qty	
	D < 0.2 mm	Ignored	
	0.2 mm < D < 0.3 mm	4	
	0.3 mm < D < 0.5 mm	2	
	0.5 mm < D	0	
	*Spots density: 10 mm		
Polarizer bubbles	Size >= 5"		
	Average Diameter	Qualified Qty	
	D < 0.25 mm	Ignored	
	0.25 mm < D < 0.5 mm	3	
	0.5 mm < D	0	
Touch panel spot	Size >= 5"		
	Average Diameter	Qualified Qty	
	D < 0.25 mm	Ignored	
	0.25 mm < D < 0.5 mm	4	
	0.5 mm < D	0	
Touch panel White line Scratch	Size >= 5"		
	Length	Width	Qualified Qty
	-	W < 0.03	Ignored
	L < 5.0	0.03 < W < 0.05	2
	-	0.05 < W	0

14 RELIABILITY TEST

NO.	TEST ITEM	TEST CONDITION	REMARK
1	High Temperature Storage	80 °C/120 hours	Note 1
2	Low Temperature Storage	-30 °C/120 hours	Note 1
3	High Temperature Operating	70 °C /120 hours	Note 1
4	Low Temperature Operating	-20 °C/120 hours	Note 1
5	High Temperature && High Humidity	Humidity 40 °C, 90 %RH, 120 hours	Note 1
6	Thermal Cycling Test (No operation)	-20 °C for 30 min, 70 °C for 30 min. 100 cycles. Then test at room temperature after 1 hour	Note 2
7	Damp Proof Test	40 °C, 90 %RH/120 hours	
8	Vibration Test	Frequency: 10 ÷ 55 Hz; Stroke: 1.5 mm; Sweep: 10 Hz ÷ 55 Hz ÷ 10 Hz; 2 hours for each direction of X, Y, Z (6 hours for total)	
9	Package Drop Test	Height: 60 cm 1 corner, 3 edges, 6 surfaces	
10	ESD Test	Air: ±2 kV, human body mode, 100 pF /1500 Ω	

Note 1. Sample quantity for each test item is 5 ÷ 10 pcs.

Note 2. Before cosmetic and function test, the product must have enough recovery time, at least 2 hours at room temperature.

15 LEGAL INFORMATION

Riverdi grants the guarantee for the proper operation of the goods for a period of 12 months from the date of possession of the goods. If in a consequence of this guarantee execution the customer has received the defects-free item as replacement for the defective item, the effectiveness period of this guarantee shall start anew from the moment the customer receives the defects-free item.

Information about device is the property of Riverdi and may be the subject of patents pending or granted. It is not allowed to copy or disclose this document to the third parties without prior written Riverdi permission.

Riverdi endeavors to ensure that the all contained information in this document is correct but does not accept liability for any error or omission. Riverdi products are in development process and published information may be not up to date. Riverdi reserves the right to update and makes changes to Specifications or written material without prior notice at any time. It is important to check the current position with Riverdi.

Images and graphics used in this document are only for illustrative the purpose. All images and graphics are possible to be displayed on the range products of Riverdi, however the quality may vary. Riverdi is not liable to the buyer or to any third party for any indirect, incidental, special, consequential, punitive or exemplary damages (including without limitation: lost profits, lost savings, or loss of business opportunities) relating to any product, service provided or to be provided by Riverdi, or the use or inability to use the same, even if Riverdi has been advised of the possibility of such damages.

Riverdi products are not fault tolerant nor designed, manufactured or intended for use or resale as on line control equipment in hazardous environments requiring fail-safe performance, such as in the operation of nuclear facilities, aircraft navigation or communication systems, air traffic control, direct life support machines or weapons systems in which the failure of the product could lead directly to death, personal injury or severe physical or environmental damage ('High-Risk Activities'). Riverdi and its suppliers specifically disclaim any expressed or implied warranty of fitness for High-Risk Activities. Using Riverdi products and devices in 'High-Risk Activities' and in any other application is entirely at the buyer's risk, and the buyer agrees to defend, indemnify and hold harmless Riverdi from any and all damages, claims or expenses resulting from such use. No licenses are conveyed, implicitly or otherwise, under any Riverdi intellectual property rights.



X-ON Electronics

Largest Supplier of Electrical and Electronic Components

Click to view similar products for [Display Modules](#) category:

Click to view products by [Riverdi](#) manufacturer:

Other Similar products are found below :

[P6153-PR](#) [TDP0700T800480PCAP](#) [P6171DPR-DC-RS](#) [P6171DPR-DC-U](#) [MIKROMEDIA 3 FOR STM32F4 CAPACITIVE FPI](#)
[TN0216ANVNANN-GN00](#) [TN0104ANVAANN-GN00](#) [TN0181ANVNANN-GN00](#) [SM-RVT101HVBFWCA0](#) [SM-RVT101HVBNWCA0](#)
[SM-RVT35HHBFWCA0](#) [SM-RVT35HHBNWCA0](#) [SM-RVT43HLBFWCA0](#) [SM-RVT43HLBNWCA0](#) [SM-RVT50HQBFWCA0](#) [SM-](#)
[RVT50HQBNWCA0](#) [SM-RVT70HSBFWCA0](#) [SM-RVT70HSBNWCA0](#) [PIM579](#) [1215686](#) [PIM543](#) [DFR0678](#) [P6191PR-DC-U-V3](#) [16381](#)
[17916](#) [18205](#) [21229](#) [12885](#) [FPM-215-R9AE](#) [11769](#) [MIKROMEDIA FOR DSPIC33](#) [MIKROMEDIA FOR PIC24](#) [MIKROMEDIA FOR](#)
[PIC32](#) [MIKROMEDIA FOR STELLARIS M3](#) [MIKROMEDIA HMI 3.5 RES](#) [MIKROMEDIA HMI 5](#) [MIKROMEDIA PLUS FOR FT90X](#)
[MIKROMEDIA PLUS FOR PIC32MX7 SHIELD](#) [MIKROMEDIA PROTO SHIELD](#) [14628](#) [MIKROMEDIA 5 FOR TIVA SHIELD](#)
[MIKROMEDIA 7 FOR STM32F4](#) [MIKROMEDIA CONNECT SHIELD](#) [MIKROMEDIA FOR ARM](#) [MIKROMEDIA FOR PSOC5LP](#)
[MIKROMEDIA GAMING SHIELD](#) [MIKROMEDIA HMI 4.3 UXB](#) [MIKROMEDIA HMI 5 RES](#) [MIKROMEDIA HMI 5 UXB](#)
[MIKROMEDIA HMI 7](#)