



RVT50HQTNWCA0

IPS RGB 5.0" LCD TFT DATASHEET

Rev.1.0

2021-07-22

ITEM	CONTENTS	UNIT
LCD Type	TFT/Transmissive/Normally Black/IPS	/
Size	5.0	Inch
Viewing Direction	Free	/
Outside Dimensions (W x H x D)	120.50 x 75.60 x 5.40	mm
Active Area (W x H)	108.00 x 64.80	mm
Pixel Pitch (W x H)	0.135 x 0.135	mm
Resolution	800 x 480 (RGB)	/
Brightness	800	cd/m ²
Color Depth	16.7 M	/
Pixel Arrangement	RGB Vertical Stripe	/
Driver IC of Board	ST7262-G4	/
Interface	RGB	/
With/Without Touch	With Projected Capacitive Touch Panel	/
CTP Driver	ILI2132A	/
Touch Interface	USB /I2C/ Optional UART	/
Weight	93	g

Note 1: RoHS3 compliant

Note 2: LCM weight tolerance: $\pm 5\%$.



1. REVISION RECORD

REV NO.	REV DATE	CONTENTS	REMARKS
1.0	2021-07-22	Initial Release	



2. CONTENTS

1.	REVISION RECORD.....	2
2.	CONTENTS.....	3
3.	MODULE CLASSIFICATION INFORMATION.....	4
4.	MODULE DRAWING.....	5
5.	ABSOLUTE MAXIMUM RATINGS.....	6
6.	ELECTRICAL CHARACTERISTICS.....	6
7.	BACKLIGHT ELECTRICAL CHARACTERISTICS.....	6
8.	ELECTRO-OPTICAL CHARACTERISTICS.....	7
9.	BLOCK DIAGRAM.....	9
10.	INTERFACES DESCRIPTION.....	10
10.1	TFT assignment.....	10
10.2	Touch panel assignment.....	10
10.3	CON1 assignment.....	10
11.	TIMING CHARACTERISTICS.....	11
11.1	RGB mode selection.....	11
11.2	System bus timing for RGB interface.....	11
11.2.1	SYNC mode.....	11
11.2.2	SYNC-DE mode.....	12
11.2.3	DE mode.....	13
11.3	Parallel 24-bit RGB input timing table.....	13
11.4	Power ON/OFF sequence.....	14
11.4.1	Power on sequence.....	14
11.4.2	Power off sequence.....	14
12.	CAPACITIVE TOUCH SCREEN PANEL SPECIFICATIONS.....	15
12.1	Mechanical characteristics.....	15
12.2	Electrical characteristics.....	15
13.	INSPECTION.....	16
13.1	Inspection condition.....	16
13.2	Inspection standard.....	17
14.	RELIABILITY TEST.....	18
15.	LEGAL INFORMATION.....	19



3. MODULE CLASSIFICATION INFORMATION

RV	T	50	H	Q	T	N	W	C	A0
1.	2.	3.	4.	5.	6.	7.	8.	9.	10.

NO.	PARAMETER	SYMBOL
1.	BRAND	RV – Riverdi
2.	PRODUCT TYPE	T – TFT Standard
3.	DISPLAY SIZE	50 – 5.0"
4.	MODEL SERIAL NO.	H – High Brightness, IPS
5.	RESOLUTION	Q – 800 x 480 px
6.	INTERFACE	T – TFT LCD, RGB
7.	FRAME	N – Without Mounting Metal Frame
8.	BACKLIGHT TYPE	W – LED White
9.	TOUCH PANEL	C – With Capacitive Touch Panel
10.	VERSION	A0 – aTouch

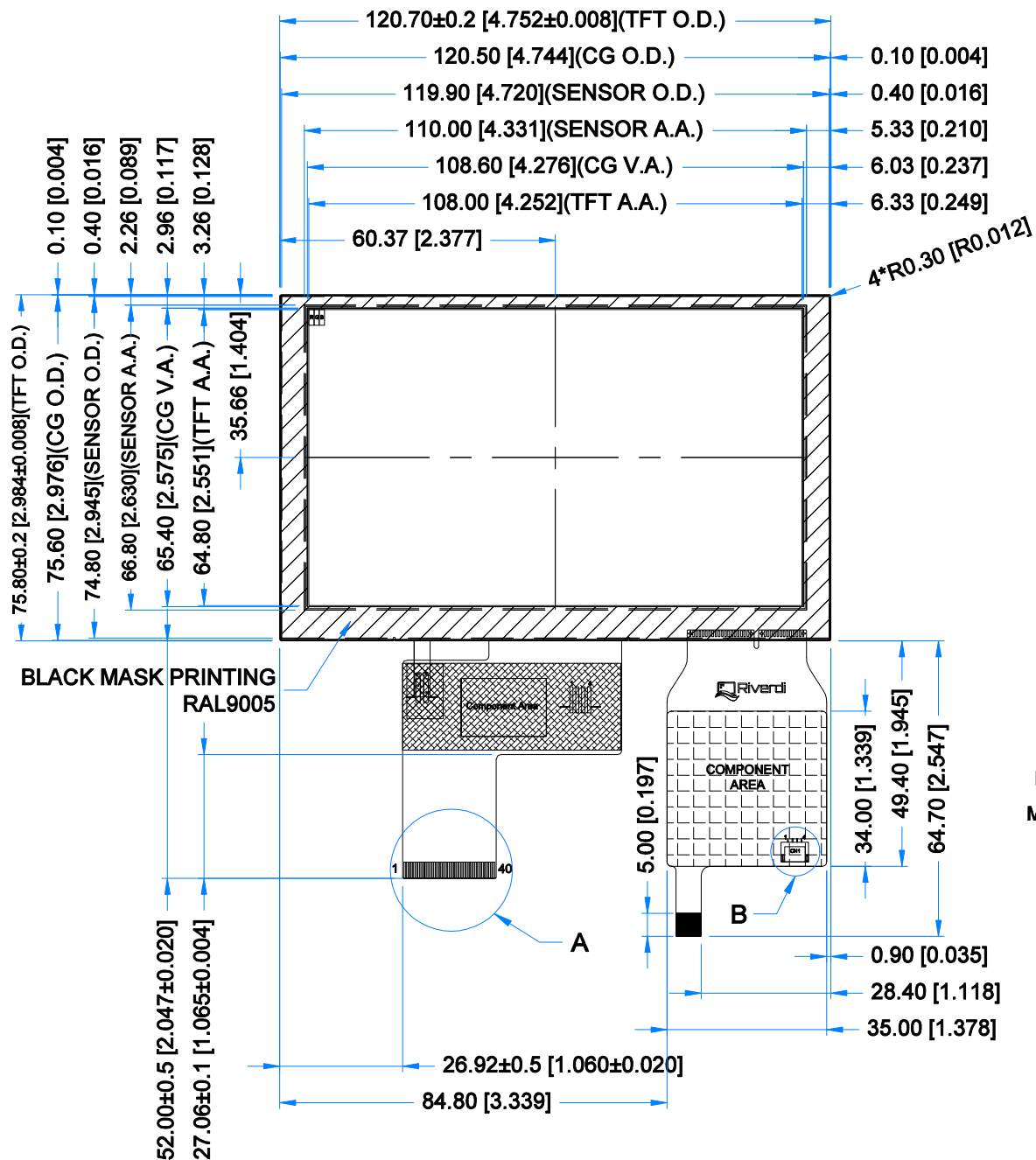

DETAIL A
SCALE 2:1

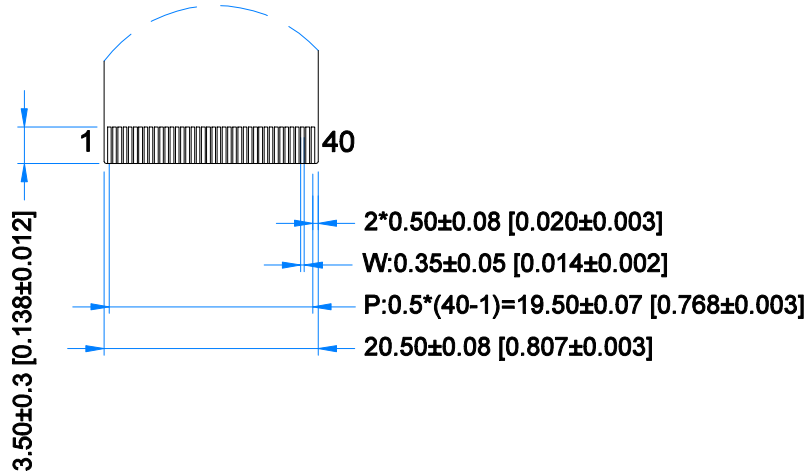

DETAIL B
SCALE 4:1

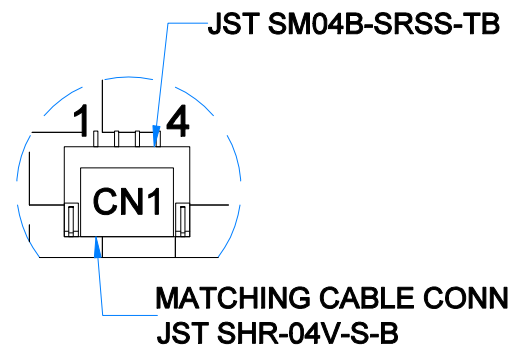

TFT NOTES:

1. LCD TYPE: TRANSMISSIVE, NORMALLY BLACK, IPS
2. RESOLUTION: 800x480
3. VIEWING ANGLE: FREE
4. IC CONTROLLER: ST7262-G4
5. OPERATING VOLTAGE: 3.3V
6. BACKLIGHT: 14-LED WHITE, Vf = 12.0V, If = 140mA

TP NOTES:

1. TP STRUCTURE: G+G
2. CG THICKNESS: 1.10mm[0.043inch]
3. DRIVER IC: ILI2132A
4. INTERFACE: USB; I2C; OPTIONAL UART
5. OPERATING VOLTAGE: 3.3V(I2C); 5.0V(USB)

GENERAL NOTE:

1. MODULE SUR
2. OPERATING T
3. STORAGE TE
4. WITHOUT IND ±0.3mm[0.012i
5. RoHS COMPLI



5. ABSOLUTE MAXIMUM RATINGS

PARAMETER	SYMBOL	MIN	MAX	UNIT
Operating Ambient temperature	T_{OP}	-20	70	°C
Storage Temperature	T_{ST}	-30	80	°C
Operating Ambient Humidity	H_{OP}	10	-	% RH
Power for Circuit Driving	V_{DD}	-0.3	5	V
Backlight Forward Current	I_{LED}	-	25	mA

Note. The above are maximum values. If exceeded, they may cause permanent damage to the unit.

6. ELECTRICAL CHARACTERISTICS

PARAMETER	SYMBOL	MIN	TYP	MAX	UNIT	
Power Supply for analog circuit	V_{DD}	3.0	3.3	3.6	V	
Logic Input Voltage	Low Voltage	V_{IL}	0	-		$0.3V_{DD}$
	High Voltage	V_{IH}	$0.7V_{DD}$	-		V_{DD}
Logic Output Voltage	Low Voltage	V_{OL}	-	-		0.4V
	High Voltage	V_{OH}	$V_{DD} - 0.4V$	-	-	
Power Consumption	Black Mode	P_b	-	80	85	mA
	Standby Mode	P_w	-	40	50	µA

7. BACKLIGHT ELECTRICAL CHARACTERISTICS

PARAMETER	SYMBOL	MIN	TYP	MAX	UNIT	NOTE
Backlight Driving Voltage	V_F	11.2	12.0	12.8	V	Notes 1, 2
Backlight Driving Current	I_F	-	140	-	mA	
Backlight Power Consumption	W_{BL}	-	1680	-	mW	
Backlight Lifetime	-	-	50,000	-	hours	Note 3

Note 1. Unless specified, the ambient temperature $T_a = 25^\circ\text{C}$

Note 2. The recommended operating conditions refer to a range in which operation of this product is guaranteed. Should this range be exceeded, the operation cannot be guaranteed even if the values may be without the absolute maximum ratings.

Note 3. If LED is driven by high current, the lifetime of LED will be reduced. Operating life means brightness goes down to 50% initial brightness. Typical operating lifetime is estimated data.



8. ELECTRO-OPTICAL CHARACTERISTICS

ITEM	SYMBOL	CONDITION	MIN	TYP	MAX	UNIT	RMK	NOTE
Response Time	Tr+Tf	$\theta=0^\circ$ $\varnothing=0^\circ$ Ta=25 °C	-	30	-	ms	FIG 1.	4
Contrast Ratio	Cr		-	1000	-	---	FIG 2.	1
Luminance Uniformity	δ WHITE		-	75	-	%	FIG 2.	3
Surface Luminance	Lv		756	800	-	cd/m ²	FIG 2.	2
Viewing Angle Range	θ	$\varnothing = 90^\circ$	-	80	-	deg	FIG 3.	6
		$\varnothing = 270^\circ$	-	80	-	deg	FIG 3.	
		$\varnothing = 0^\circ$	-	80	-	deg	FIG 3.	
		$\varnothing = 180^\circ$	-	80	-	deg	FIG 3.	
CIE (x, y) Chromaticity	Rx	$\theta=0^\circ$ $\varnothing=0^\circ$ Ta=25 °C	0.575	0.615	0.655	-	FIG 2.	5
	Ry		0.296	0.336	0.376	-		
	Gx		0.352	0.392	0.432	-		
	Gy		0.512	0.552	0.592	-		
	Bx		0.100	0.140	0.180	-		
	By		0.085	0.125	0.165	-		
	Wx		0.274	0.316	0.358	-		
	Wy		0.295	0.336	0.378	-		

Note 1. Contrast Ratio (CR) is defined mathematically as below, for more information see Figure 1.

$$\text{Contrast Ratio} = \frac{\text{Average Surface Luminance with all white pixels (P1, P2, P3, P4, P5)}}{\text{Average Surface Luminance with all black pixels (P1, P2, P3, P4, P5)}}$$

Note 2. Surface luminance is the LCD surface from the surface with all pixels displaying white. For more information see Figure 2.

$$L_v = \text{Average Surface Luminance with all white pixels (P1, P2, P3, P4, P5)}$$

Note 3. The uniformity in surface luminance δ WHITE is determined by measuring luminance at each test position 1 through 5, and then dividing the minimum luminance of 5 points luminance by maximum luminance of 5 points luminance. For more information see Figure 2.

$$\delta \text{ WHITE} = \frac{\text{Minimum Surface Luminance with all white pixels (P1, P2, P3, P4, P5)}}{\text{Maximum Surface Luminance with all white pixels (P1, P2, P3, P4, P5)}}$$

Note 4. Response time is the time required for the display to transition from white to black (Rise Time, Tr) and from black to white (Decay Time, Tf). For additional information see Figure 1. The test equipment is Autronic-Melchers's ConoScope series.

Note 5. CIE (x, y) chromaticity, the x, y value is determined by measuring luminance at each test position 1 through 5, and then make average value.

Note 6. Viewing angle is the angle at which the contrast ratio is greater than 2. For TFT module the contrast ratio is greater than 10. The angles are determined for the horizontal or x axis and the vertical or y axis with respect to the z axis which is normal to LCD surface. For more information see Figure 3.

Note 7. For viewing angle and response time testing, the testing data is based on Autronic-Melchers's ConoScope series. Instruments for Contrast Ratio, Surface Luminance, Luminance Uniformity, CIE the test data is based on TOPCON's BM-5 photo detector.

Figure 1. The definition of response time

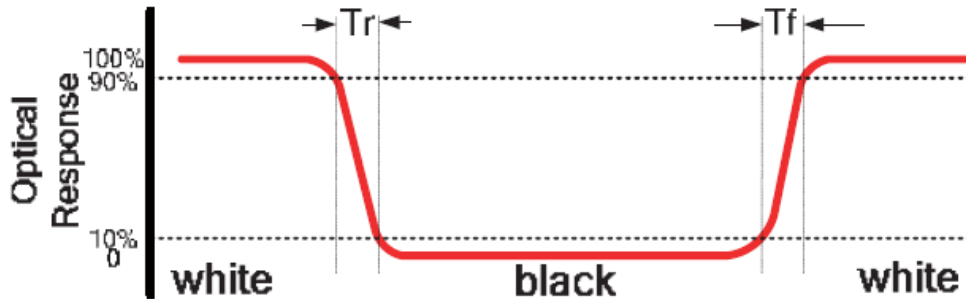
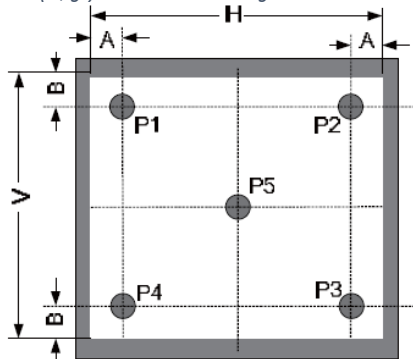

Figure 2. Measuring method for Contrast ratio, surface luminance, Luminance uniformity, CIE (x, y) chromaticity



A: 5mm

B: 5mm

H, V: Active Area

Light spot size $\phi=5\text{mm}$, 500mm distance from the LCD surface to detector lens.

Measurement instrument is TOPCON'S luminance meter BM-5

Figure 3. The definition of viewing angle

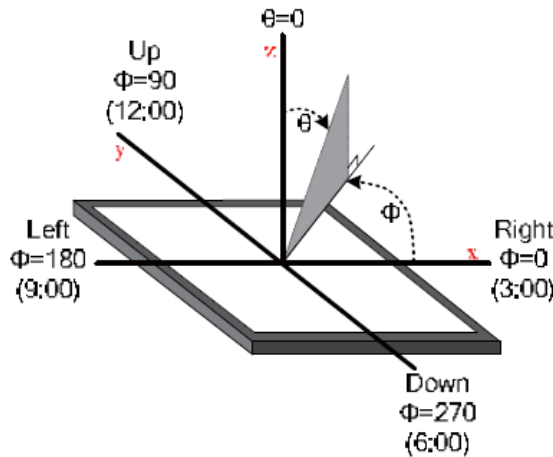



9. BLOCK DIAGRAM

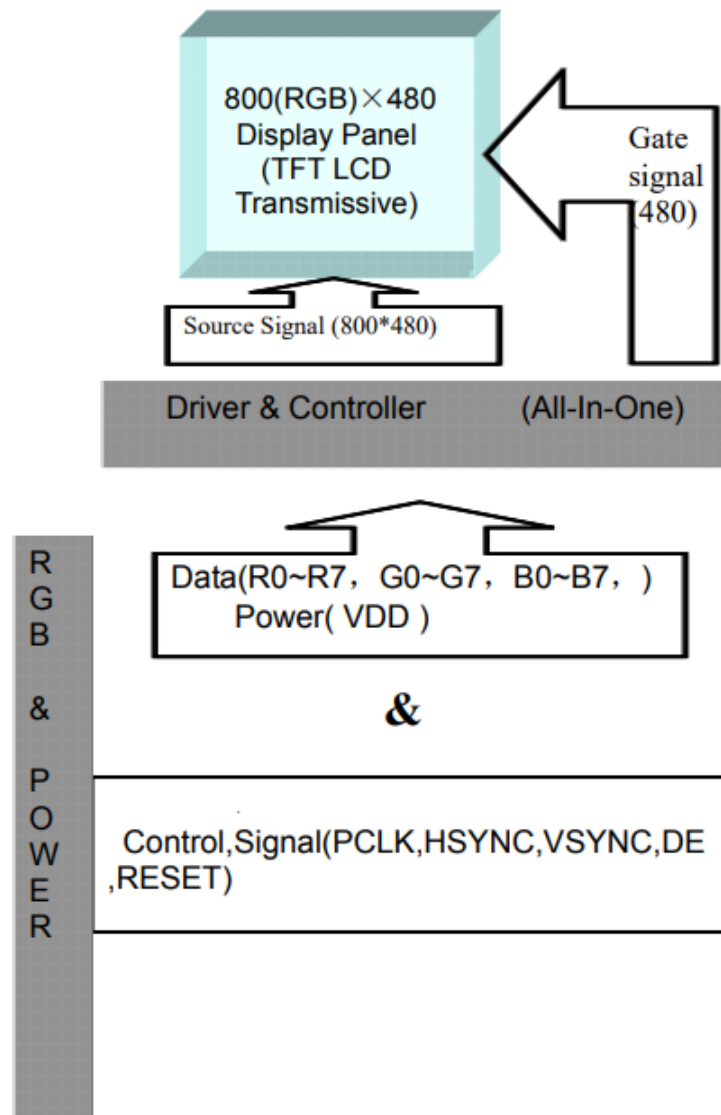



10. INTERFACES DESCRIPTION

10.1 TFT assignment

PIN NO.	SYMBOL	DESCRIPTION
1	VLED-	Backlight Power Input PIN Cathode
2	VLED+	Backlight Power Input PIN Anode
3	GND	Ground
4	VDD	Power Supply Voltage
5-12	R0-R7	Red Data
13-20	G0-G7	Green Data
21-28	B0-B7	Blue Data
29	GND	Ground
30	DCLK	Clock for Input Data
31	DISP	Display on/off Control
32	HSYNC	Horizontal Synchronized Signal
33	VSYNC	Vertical Synchronized Signal
34	DE	Data Input Enable
35	NC	Not Connect
36	GND	Ground
37	NC/XR	No Connection
38	NC/YD	No Connection
39	NC/XL	No Connection
40	NC/YU	No Connection

10.2 Touch panel assignment

PIN NO.	SYMBOL	DESCRIPTION	NOTE
1	USB_GND	USB_Ground	
2	USB_VDD	USB Power for CTP, 5.0V	
3	USB_D-	USB_Data Signal -	
4	USB_D+	USB_Data Signal +	
5	I2C_GND	I2C_Ground	
6	I2C_VDD	I2C_Power for CTP, 3.3 V	
7	I2C_RST	I2C_Reset Pin, Active low	Note 1
8	I2C_SCL	I2C_Clock Input	
9	I2C_INT	I2C_Interrupt Signal from CTP, Active low	
10	I2C_SDA	I2C_Data Signal	

Note 1. External pull-up resistors are required.

10.3 CON1 assignment

PIN NO.	SYMBOL	DESCRIPTION
1	USB_VDD	USB_Power for CTP, DC 5.0V
2	USB_D-	USB_Data Signal -
3	USB_D+	USB_Data Signal +
4	USB_GND	USB_Ground



11. TIMING CHARACTERISTICS

11.1 RGB mode selection

RGB MODE SELECTION	DCLK	HSYNC	VSYNC	DE
SYNC-DE Mode	Input	Input	Input	Input
SYNC Mode	Input	Input	Input	GND
DE Mode	Input	GND	GND	Input

11.2 System bus timing for RGB interface

11.2.1 SYNC mode

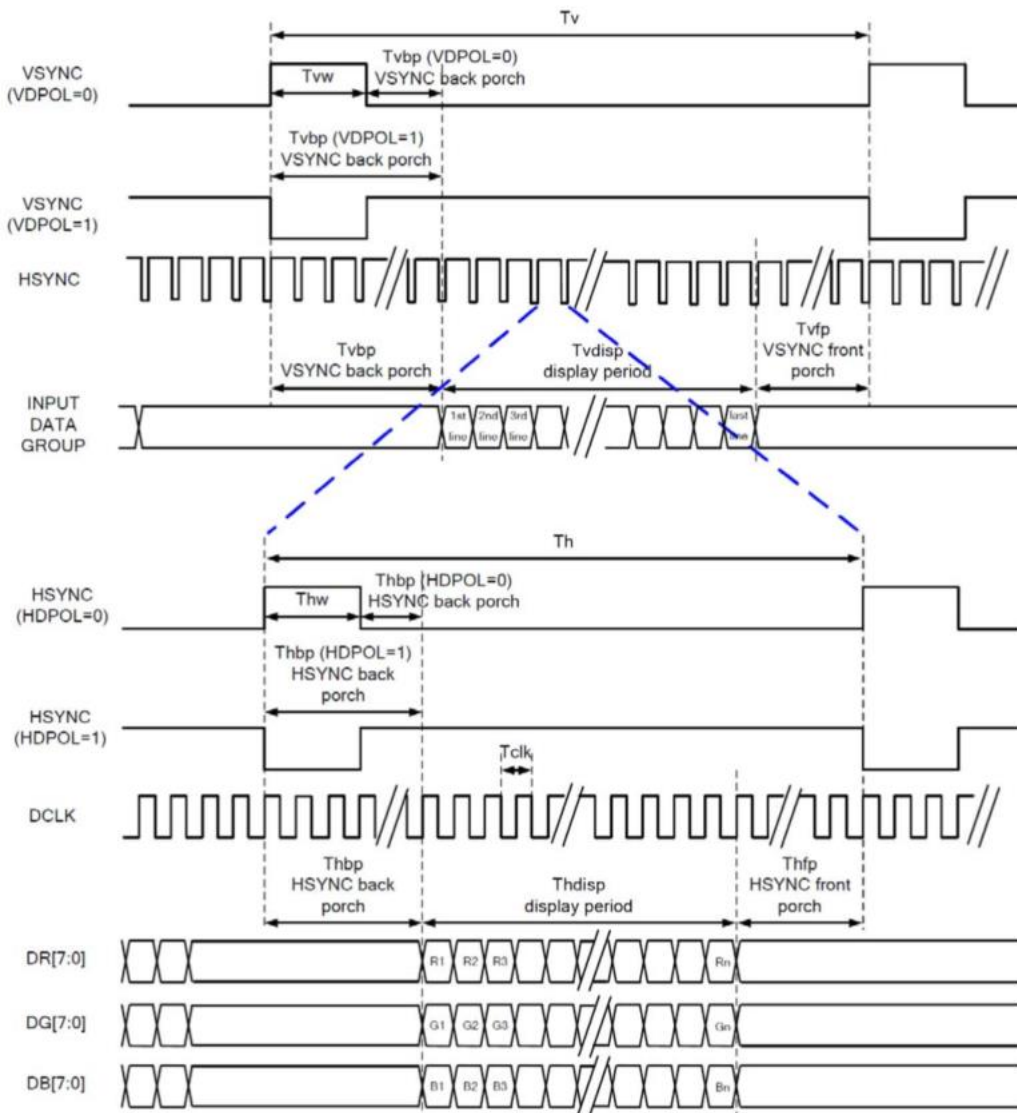



11.2.2 SYNC-DE mode

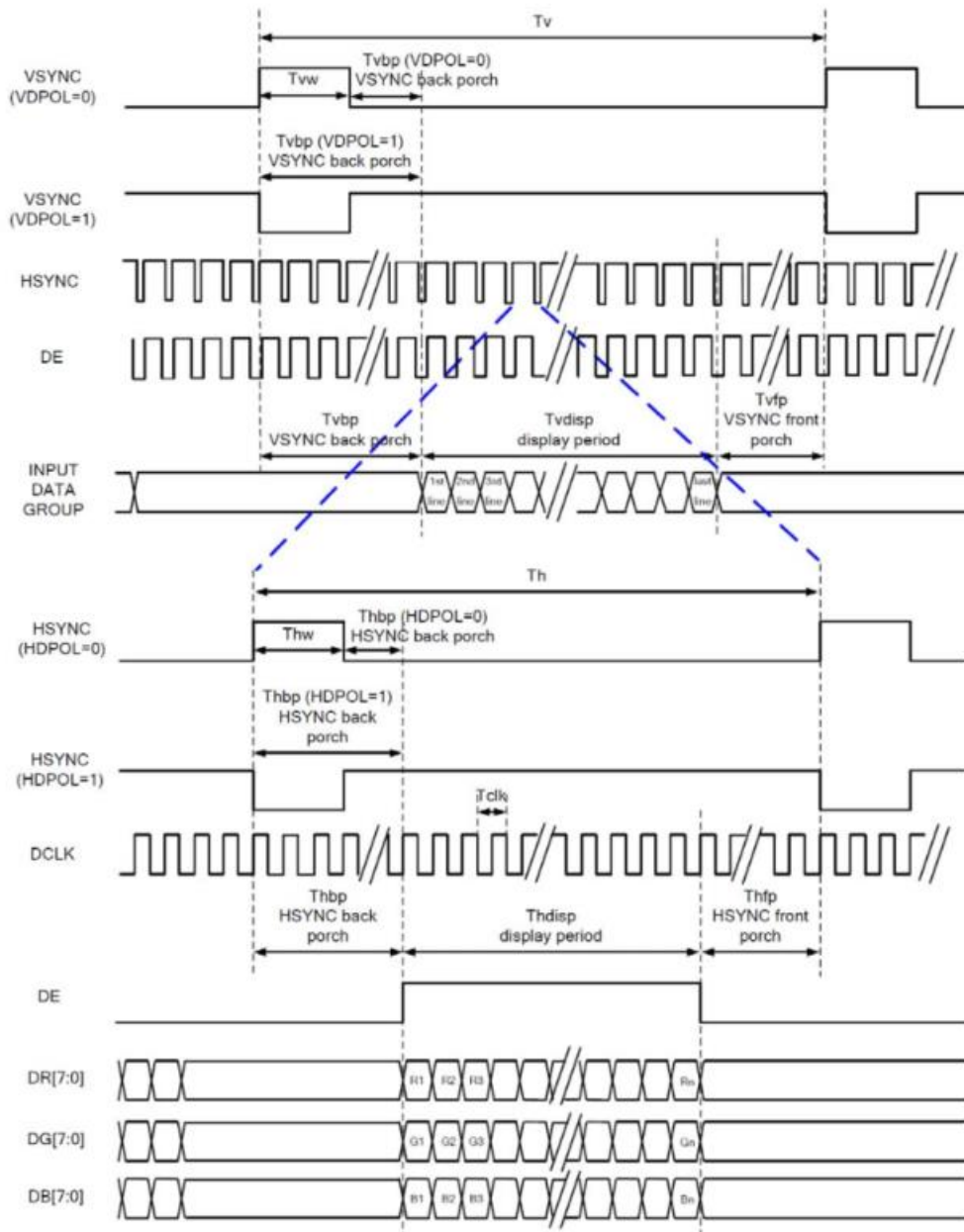



11.2.3 DE mode

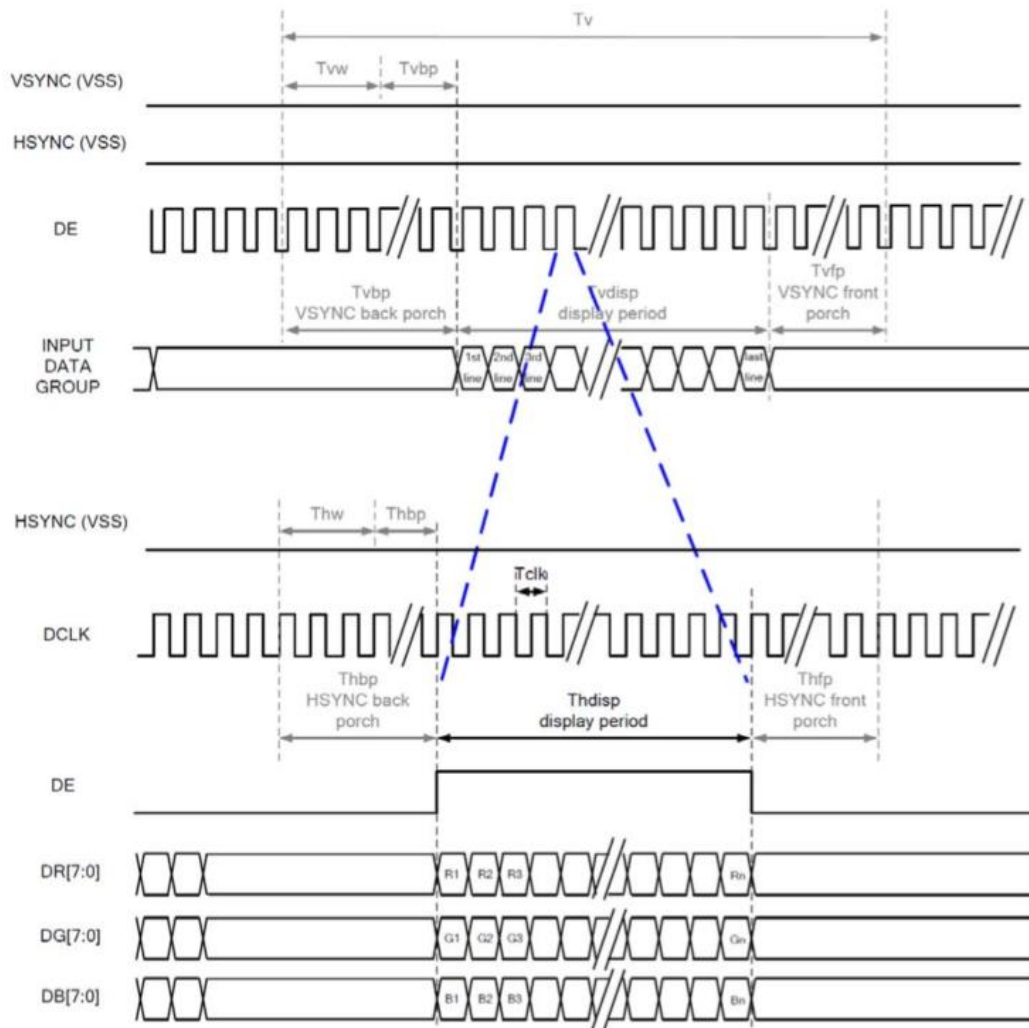

11.3 Parallel 24-bit RGB input timing table

Parallel 24-bit RGB input Timing (PVDD=VDD=VDDI=3.3V, AGND=0V, Ta=25 °C)

PARAMETER		SYMBOL	MIN	TYP	MAX	UNIT
DCLK Frequency		Fclk	23	25	27	MHz
HSYNC	Period Time	Th	808	816	896	DCLK
	Display Period	Thdisp	800			
	Hsync Back Porch	Thbp	4	8	48	
	Hsync Front Porch	Thfp	4	8	48	
	Hsync Pulse Width	Thw	2	4	8	
VSYNC	Period Time	Tv	488	496	504	HSYNC
	Display Period	Tvdisp	480			
	Vsync Back Porch	Tvbp	4	8	12	
	Vsync Front Porch	Tvfp	4	8	12	
	Vsync Pulse Width	Tvw	2	4	8	

11.4 Power ON/OFF sequence

11.4.1 Power on sequence

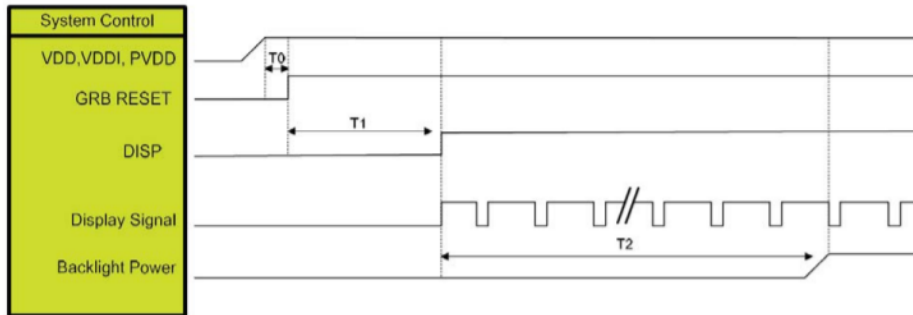

SYMBOL	DESCRIPTION	MIN. TIME	UNIT
T0	System power stability to GRB RESET signal	0	ms
T1	GRB RESET=" High" to DISP=" High"	10	
T2	Display Signal output to Backlight Power on	250	

Note. RGB interface display signal: DCLK, VSYNC, HSYNC, DE, DR [7:0], DB [7:0].

11.4.2 Power off sequence

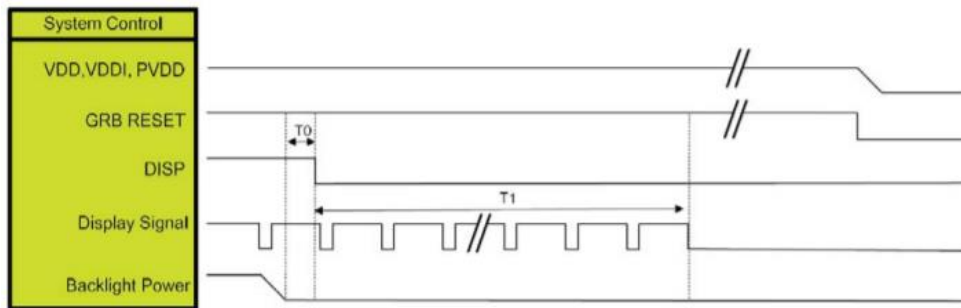

SYMBOL	DESCRIPTION	MIN. TIME	UNIT
T0	Backlight Power off to DISP=" Low"	5	ms
T1	DISP =" Low" to IC internal voltage discharge complete	100	ms

Note. RGB interface display signal: DCLK, VSYNC, HSYNC, DE, DR [7:0], DB [7:0]



12. CAPACITIVE TOUCH SCREEN PANEL SPECIFICATIONS

12.1 Mechanical characteristics

DESCRIPTION	SPECIFICATION	REMARK
Touch Panel Size	5.0 inch	aTouch
Outline Dimension of CTP	120.50 mm x 75.60 mm	
Product Thickness	2.45 mm	
Glass Thickness	1.1 mm	
CTP View Area	108.60 mm x 65.40 mm	
Sensor Active Area	110.00 mm x 66.80 mm	
Structure type	Glass + Glass	
Surface Hardness	7H	

12.2 Electrical characteristics

DESCRIPTION	SPECIFICATION	
Power Consumption (IDD)	Active Mode	90 mA
	Sleep Mode	10 mA
Linearity	+/- 1.5mm	
Controller	ILI2132A	
Resolution	800 x 480	

13. INSPECTION

Standard acceptance/rejection criteria for TFT module

13.1 Inspection condition

Ambient conditions:

- Temperature: $25 \pm 2^{\circ}\text{C}$
- Humidity: $(60 \pm 10) \%RH$
- Illumination: Single fluorescent lamp non-directive (300 to 700 lux)

Viewing distance: $35 \pm 5\text{cm}$ between inspector bare eye and LCD.

Viewing Angle: U/D: $45^{\circ}/45^{\circ}$, L/R: $45^{\circ}/45^{\circ}$

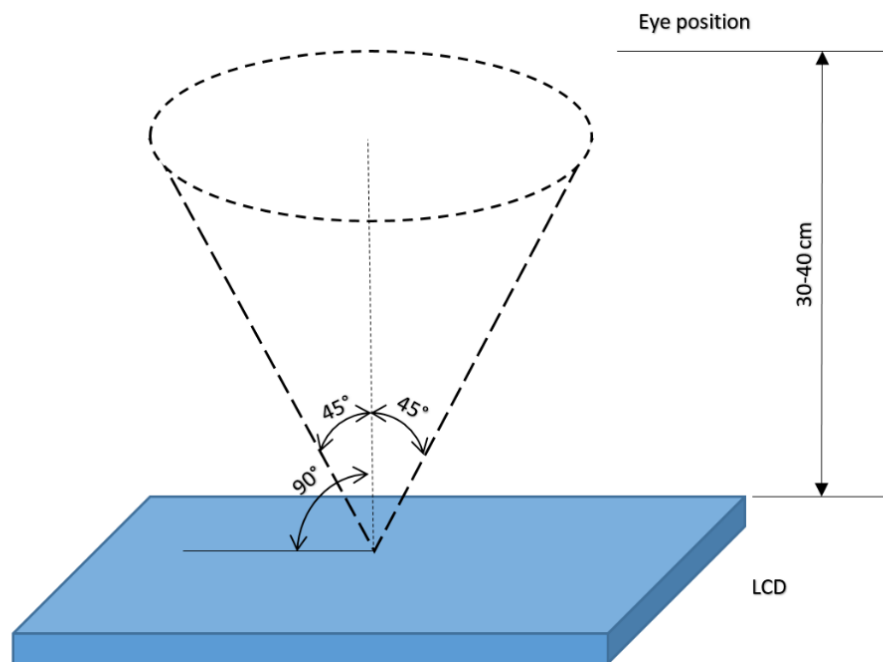

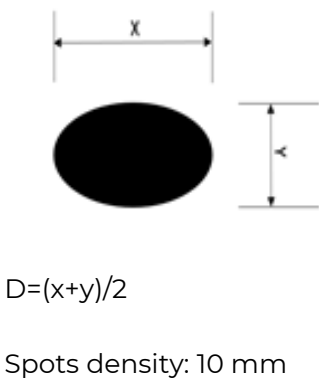
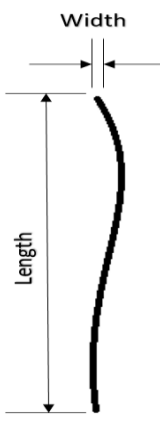

13.2 Inspection standard

ITEM		CRITERION		
Black spots, white spots, light leakage, Foreign Particle (round Type)	 <p>$D=(x+y)/2$ Spots density: 10 mm</p>	3.5" ≤ Size ≤ 5"		
		Average Diameter	Qualified Qty	
		D ≤ 0.15 mm	Ignored	
		0.15 mm < D ≤ 0.3 mm	N≤3	
		0.3mm < D	Not allowed	
LCD black spots, white spots, light leakage (line Type)	 <p>Spots density: 10 mm</p>	3.5" ≤ Size ≤ 5"		
		Length	Width	Qualified Qty
		-	W ≤ 0.03	Ignored
		L ≤ 3.0	0.03 < W ≤ 0.05	2
		L ≤ 3.0	0.05 < W ≤ 0.1	1
		3.0 < L	0.10 < W	Not allowed
Bright/Dark Dots	3.5" ≤ Size ≤ 5"			
	Item	Qualified Qty		
	Bright dots	N ≤ 1		
	Dark dots	N ≤ 2		
Total Bright and Dark Dots		N ≤ 3		
Clear spots	Size ≤ 5"			
	Average Diameter	Qualified Qty		
	D < 0.2 mm	Ignored		
	0.2 mm < D < 0.3 mm	3		
	0.3 mm < D < 0.5 mm	2		
	0.5 mm < D	0		
Spots density: 10 mm				
Polarizer bubbles	3.5" ≤ Size ≤ 5"			
	Average Diameter	Qualified Qty		
	D ≤ 0.2 mm	Ignored		
	0.2 mm < D ≤ 0.3 mm	2		
	0.2 mm < D ≤ 0.5 mm	1		
	0.5 mm < D	0		
Total Q'ty		3		
Size ≤ 5"				



Touch panel spots	Average Diameter		Qualified Qty
	D < 0.2 mm		Ignored
	0.2 mm < D < 0.4 mm		5
	0.4 mm < D < 0.5 mm		2
	0.5 mm < D		0
Touch panel white line scratch	Size ≤ 5"		
	Length	Width	Qualified Qty
	-	W < 0.02	Ignored
	L < 3.0	0.02 < W < 0.05	2
	L < 5.0	0.05 < W < 0.08	2
	-	0.08 < W	0

14. RELIABILITY TEST

NO.	TEST ITEM	TEST CONDITION	NOTE
1	High Temperature Storage	80°C/120 hours	Note 1
2	Low Temperature Storage	-30°C/120 hours	
3	High Temperature Operating	70 °C /120 hours	
4	Low Temperature Operating	-20°C/120 hours	
5	High Temperature and High Humidity	Humidity 40°C, 90%RH, 120Hrs	
6	Thermal Cycling Test (No operation)	-20°C for 30min, 70°C for 30 min. 100 cycles. Then test at room temperature after 1 hour	Note 2
7	Vibration Test	Frequency: 10 ÷ 55 Hz. Stroke: 1.5 mm. Sweep: 10Hz ÷ 55Hz ÷ 10 Hz. 2 hours for each direction of X, Y, Z (Total 6 hours)	
8	Package Drop Test	Height: 60 cm 1 corner, 3 edges, 6 surfaces	

Note 1. Sample quantity for each test item is 5 ÷ 10 pcs.

Note 2. Before cosmetic and function test, the product must have enough recovery time, at least 2 hours at room temperature.



15. LEGAL INFORMATION

Riverdi grants the guarantee for the proper operation of the goods for a period of 12 months from the date of possession of the goods. If in a consequence of this guaranteed execution the customer has received the defects-free item as replacement for the defective item, the effectiveness period of this guarantee shall start anew from the moment the customer receives the defects-free item.

Information about device is the property of Riverdi and may be the subject of patents pending or granted. It is not allowed to copy or disclosed this document without prior written permission.

Riverdi endeavors to ensure that all contained information in this document is correct but does not accept liability for any error or omission. Riverdi products are in developing process and published information may be not up to date. Riverdi reserves the right to update and makes changes to Specifications or written material without prior notice at any time. It is important to check the current position with Riverdi.

Images and graphics used in this document are only for illustrative the purpose. All images and graphics are possible to be displayed on the range products of Riverdi, however the quality may vary. Riverdi is no liable to the buyer or to any third party for any indirect, incidental, special, consequential, punitive, or exemplary damages (including without limitation lost profits, lost savings, or loss of business opportunity) relating to any product, service provided or to be provided by Riverdi, or the use or inability to use the same, even if Riverdi has been advised of the possibility of such damages.

Riverdi products are not fault tolerant nor designed, manufactured or intended for use or resale as on line control equipment in hazardous environments requiring fail-safe performance, such as in the operation of nuclear facilities, aircraft navigation or communication systems, air traffic control, direct life support machines or weapons systems in which the failure of the product could lead directly to death, personal injury or severe physical or environmental damage ('High-Risk Activities'). Riverdi and its suppliers specifically disclaim any expressed or implied warranty of fitness for High-Risk Activities. Using Riverdi products and devices in 'High-Risk Activities' and in any other application is entirely at the buyer's risk, and the buyer agrees to defend, indemnify, and hold harmless Riverdi from all damages, claims or expenses resulting from such use. No licenses are conveyed, implicitly or otherwise, under any Riverdi intellectual property rights.

Hi, I am here to help you!
If you have any additional
questions, please contact
our support via email:
contact@riverdi.com

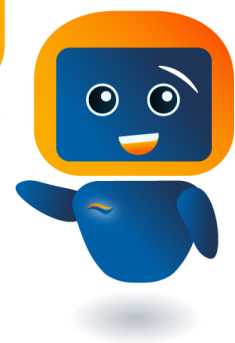

X-ON Electronics

Largest Supplier of Electrical and Electronic Components

Click to view similar products for [TFT Displays & Accessories](#) category:

Click to view products by [Riverdi](#) manufacturer:

Other Similar products are found below :

[F3ET2-005-150](#) [HDA430T-3G1H](#) [NB7W-KBA04](#) [NB-ATT01](#) [NB5Q-ATT01](#) [NB5Q-KBA04](#) [NB-CN001](#) [OAI-80038AA-2008-A](#) [315-U004B15300](#) [TCG121WXLRXVNNANX35](#) [EIC-LCD-1080P](#) [T-55619GD065J-LW-ABN](#) [NLB150XG02L-01](#) [NL192108AC10-01D](#) [NL6448AC18-08F](#) [NL8060BC26-35BA](#) [NL6448BC26-26D](#) [NL8060BC31-50F](#) [TM070DDHG03-40](#) [PTPW16-070WV1S02](#) [PTPW16-084SV1S02](#) [MTD0300ECP06DF-1](#) [4DLCD-35480320-CTP-IPS](#) [4DLCD-35480320-IPS](#) [4DLCD-35480320-RTP-IPS](#) [4DLCD-50800480-CTP-IPS](#) [RFA6400E-AWH-DNG](#) [RFE430V-AZW-DNS](#) [RFF70BQ-1IW-DBG](#) [RFF70VA2-1IW-DHS](#) [RFH700A8-AYH-MNN](#) [RFK101VF-1YH-LHG](#) [RFS52VA-1ZH-DHN](#) [SM-RVT101HVHFWN00](#) [SM-RVT101HVHNWC00](#) [SM-RVT101HVHNWCA0](#) [SM-RVT101HVHNWN00](#) [SM-RVT101HVLFWCA0](#) [SM-RVT101HVLNWCA0](#) [SM-RVT35HHTFWCA0](#) [SM-RVT35HHTNWCA0](#) [SM-RVT43HLTFWCA0](#) [SM-RVT43HLTNWCA0](#) [SM-RVT50HQTFWCA0](#) [SM-RVT50HQTNWCA0](#) [SM-RVT70AQLFWR00](#) [SM-RVT70AQLNWR00](#) [SM-RVT70HSLFWCA0](#) [SM-RVT70HSMFWCA0](#) [SM-RVT70HSMFWN00](#)