



RVT70HSMNWCA0

IPS MIPI 7.0" LCD TFT DATASHEET

Rev.1.0

2021-08-02

ITEM	CONTENTS	UNIT
LCD Type	TFT/Transmissive/Normally Black/IPS	/
Size	7.0	Inch
Viewing Direction	Free	/
Outside Dimensions (W x H x D)	164.90 x 100.00 x 8.15	mm
Active Area (W x H)	154.21 x 85.92	mm
Pixel Pitch (W x H)	0.1506 x 0.1432	mm
Resolution	1024 (RGB) x 600	/
Brightness	800	cd/m ²
LCD Interface Type	MIPI	/
Color Depth	16.7 M	/
Pixel Arrangement	RGB Vertical Stripe	/
LCD Driver	EK79007AD3+EK73217BCGA	/
With/Without Touch	With Projected Capacitive Touch Panel	/
CTP Driver	ILI2132A	/
Touch Interface	USB /I2C/Optional UART	/
Weight	205	g

Note 1: RoHS3 compliant

Note 2: LCM weight tolerance: $\pm 5\%$.



1. REVISION RECORD

REV NO.	REV DATE	CONTENTS	REMARKS
1.0	2021-08-02	Initial Release	



2. CONTENTS

1.	REVISION RECORD.....	2
2.	CONTENTS.....	3
3.	MODULE CLASSIFICATION INFORMATION.....	4
4.	MODULE DRAWING.....	5
5.	ABSOLUTE MAXIMUM RATINGS.....	6
6.	ELECTRICAL CHARACTERISTICS.....	6
7.	BACKLIGHT ELECTRICAL CHARACTERISTICS.....	6
8.	ELECTRO-OPTICAL CHARACTERISTICS.....	7
9.	INTERFACE DESCRIPTION.....	9
9.1	TFT assignment.....	9
9.2	Touch panel assignment.....	10
9.3	CON1 assignment.....	11
10.	TIMING CHARACTERISTICS.....	11
10.1	Low power transmitter AC characteristic.....	11
10.2	High speed transmission.....	12
10.3	High speed clock transmission.....	13
10.4	High speed data transmission in bursts.....	14
11.	CAPACITIVE TOUCH SCREEN PANEL SPECIFICATIONS.....	14
11.1	Mechanical characteristics.....	14
11.2	Electrical characteristics.....	14
12.	INITIALIZATION CODE.....	15
13.	INSPECTION.....	16
13.1	Inspection condition.....	16
13.2	Inspection standard.....	17
14.	RELIABILITY TEST.....	18
15.	LEGAL INFORMATION.....	19



3. MODULE CLASSIFICATION INFORMATION

RV	T	70	H	S	M	N	W	C	A0
1.	2.	3.	4.	5.	6.	7.	8.	9.	10.

NO.	PARAMETER	SYMBOL
1.	BRAND	RV – Riverdi
2.	PRODUCT TYPE	T – TFT Standard
3.	DISPLAY SIZE	70 – 7.0”
4.	MODEL SERIAL NO.	H – High Brightness, IPS
5.	RESOLUTION	S – 1024 x 600 px
6.	INTERFACE	M – MIPI
7.	FRAME	N – Without Mounting Metal Frame
8.	BACKLIGHT TYPE	W – LED White
9.	TOUCH PANEL	C – With Capacitive Touch Panel, aTouch
10.	VERSION	A0 – aTouch

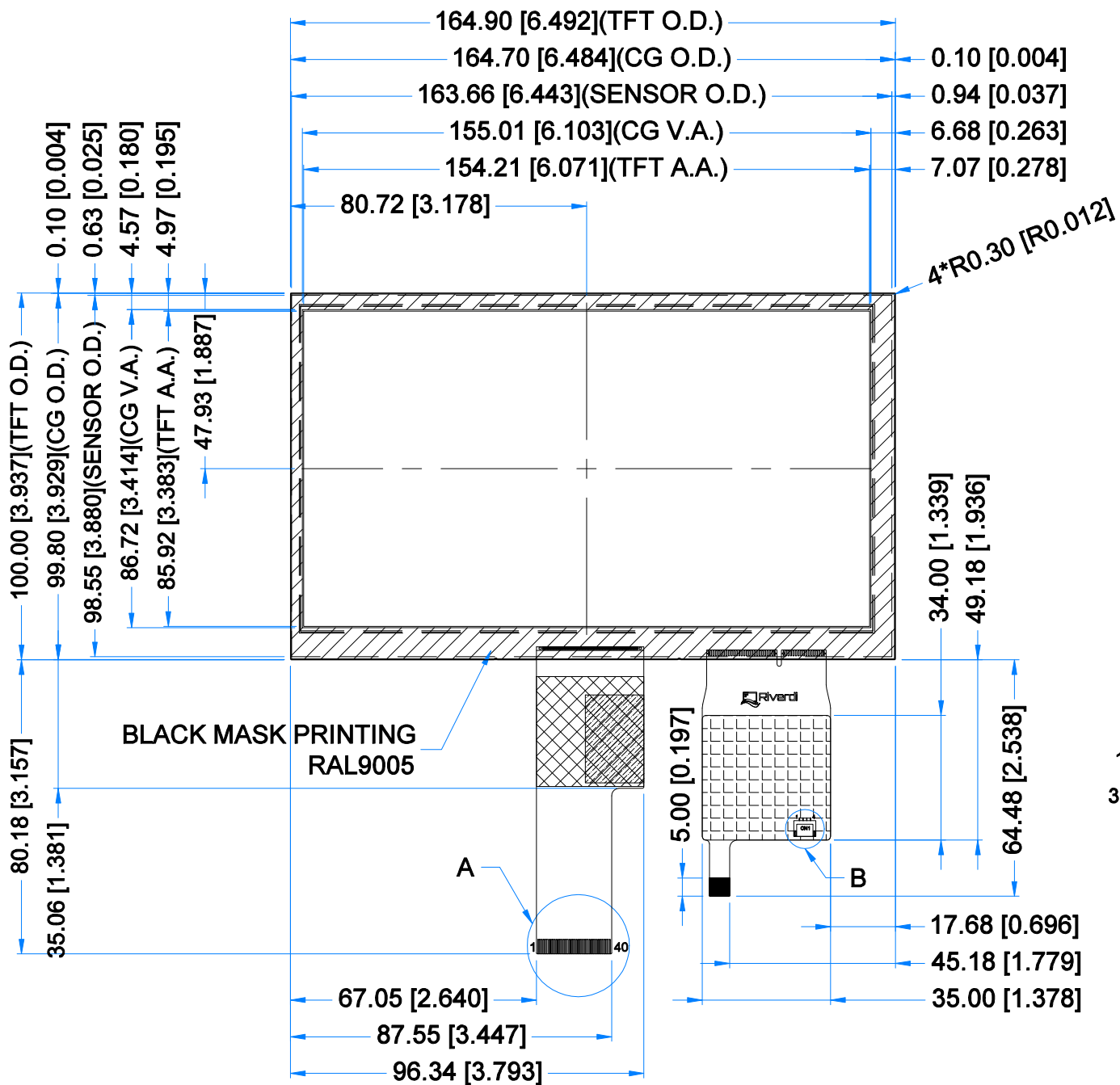

DETAIL A
SCALE 2:1

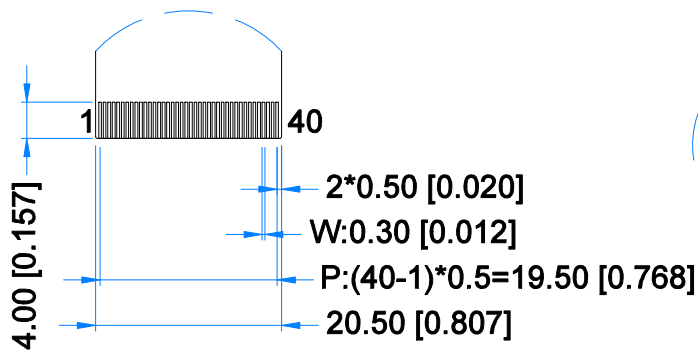

DETAIL B
SCALE 4:1

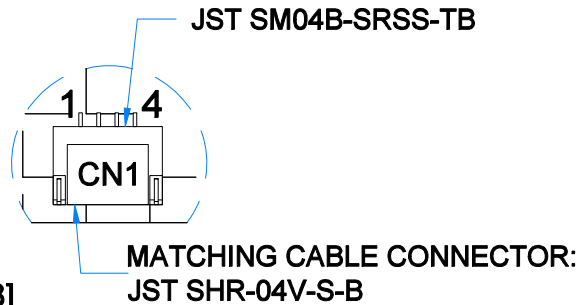

DETAIL C
SCALE 4:1

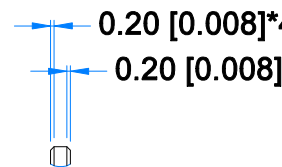

TFT NOTES:

1. LCD TYPE: TRANSMISSIVE, NORMALLY BLACK, IPS
2. RESOLUTION: 1024x600
3. VIEWING ANGLE: FREE
4. IC CONTROLLER: EK79007AD3+EK73217BCGA
5. OPERATING VOLTAGE: 3.3V
6. INTERFACE: MIPI
7. BACKLIGHT: 27 LEDS WHITE, $V_f = 9.6V$, $I_f = 270mA$

TP NOTES:

1. TP STRUCTURE: G+G
2. CG THICKNESS: 1.10 mm
3. DRIVER IC: ILI2132A
4. INTERFACE: USB /I2C/OPTIONAL UART
3. OPERATING VOLTAGE: 3.3V(CTP I2C); 5.0V(CTP USB)

GENERAL NOTES:

1. MODULE SURF
2. OPERATING T
3. STORAGE TE
4. WITHOUT IND
5. RoHS3 COMPI



5. ABSOLUTE MAXIMUM RATINGS

PARAMETER	SYMBOL	MIN	MAX	UNIT
Power for Circuit Driving	VDD	-0.3	+4.6	V
Operating Temperature	T _{OP}	-20	70	°C
Storage Temperature	T _{ST}	-30	80	°C
Storage Humidity (@ 25 ± 5°C)	H _{ST}	10	-	% RH
Operating Ambient Humidity (@ 25 ± 5°C)	H _{OP}	10	-	% RH

Note. The above are maximum values. If exceeded, they may cause permanent damage to the unit.

6. ELECTRICAL CHARACTERISTICS

PARAMETER	SYMBOL	MIN	TYP	MAX	UNIT
Supply Voltage for Module	VDD	2.6	3.3	3.6	V
Digital Power Current	IDD	-	30	45	mA
Logic Input Signal Voltage	VIH	0.7VDD	-	VDD	V
	VIL	0	-	0.3VDD	V

7. BACKLIGHT ELECTRICAL CHARACTERISTICS

PARAMETER	SYMBOL	MIN	TYP	MAX	UNIT
Backlight Driving Voltage	VF	9.0	9.6	10.2	V
Backlight Driving Current	IF	-	270	315	mA
Backlight Power Consumption	WBL	-	2592	-	mW
Lifetime	-	-	50,000	-	

Note. Operating life means the period in which the LED brightness goes down to 50% of the initial brightness. Typical operating lifetime is the estimated parameter.



8. ELECTRO-OPTICAL CHARACTERISTICS

Optical characteristics are determined after the unit has been 'ON' and stable for approximately 30 minutes in a dark environment at 25 °C. The values specified are at an approximate distance 500mm from the LCD surface at a viewing angle of Φ and θ equal to 0°.

ITEM	SYMBOL	CONDITION	MIN	TYP	MAX	UNIT	RMK	NOTE
Response Time	Tr+Tf	$\theta=0^\circ$ $\phi=0^\circ$ Ta=25 °C	-	35	-	ms	FIG 1.	4
Contrast Ratio	Cr		-	800	-	---	FIG 2.	1
Luminance Uniformity	δ WHITE		-	75	-	%	FIG 2.	3
Surface Luminance	Lv		-	800	-	cd/m2	FIG 2.	2
Viewing Angle Range	θ	$\phi = 90^\circ$	-	85	-	deg	FIG 3.	6
		$\phi = 270^\circ$	-	85	-	deg	FIG 3.	
		$\phi = 0^\circ$	-	85	-	deg	FIG 3.	
		$\phi = 180^\circ$	-	85	-	deg	FIG 3.	
CIE (x, y) Chromaticity	Rx	$\theta=0^\circ$ $\phi=0^\circ$ Ta=25 °C	0.578	0.618	0.658	-	FIG 2.	5
	Ry		0.489	0.329	0.369	-		
	Gx		0.376	0.416	0.456	-		
	Gy		0.493	0.533	0.573	-		
	Bx		0.071	0.111	0.151	-		
	By		0.108	0.148	0.188	-		
	Wx		0.270	0.310	0.350	-		
	Wy		0.290	0.330	0.370	-		

Note 1. Contrast Ratio (CR) is defined mathematically as below, for more information see Figure 2.

$$\text{Contrast Ratio} = \frac{\text{Average Surface Luminance with all white pixels (P1, P2, P3, P4, P5)}}{\text{Average Surface Luminance with all black pixels (P1, P2, P3, P4, P5)}}$$

Note 2. Surface luminance is the LCD surface from the surface with all pixels displaying white. For more information see Figure 2.

$$L_v = \text{Average Surface Luminance with all white pixels (P1, P2, P3, P4, P5)}$$

Note 3. The uniformity in surface luminance δ WHITE is determined by measuring luminance at each test position 1 through 5, and then dividing the minimum luminance of 5 points luminance by maximum luminance of 5 points luminance. For more information see Figure 2.

$$\delta \text{ WHITE} = \frac{\text{Minimum Surface Luminance with all white pixels (P1, P2, P3, P4, P5)}}{\text{Maximum Surface Luminance with all white pixels (P1, P2, P3, P4, P5)}}$$

Note 4. Response time is the time required for the display to transition from white to black (Rise Time, Tr) and from black to white (Decay Time, Tf). For additional information see Figure 1. The test equipment is Autronic-Melchers's ConoScope series.

Note 5. CIE (x, y) chromaticity, the x, y value is determined by measuring luminance at each test position 1 through 5, and then make average value.

Note 6. Viewing angle is the angle at which the contrast ratio is greater than 2. For TFT module the contrast ratio is greater than 10. The angles are determined for the horizontal or x axis and the vertical or y axis with respect to the z axis which is normal to LCD surface. For more information see figure 3.

Note 7. For viewing angle and response time testing, the testing data is based on Autronic-Melchers's ConoScope series. Instruments for Contrast Ratio, Surface Luminance, Luminance Uniformity, CIE the test data is based on TOPCON's BM-5 photo detector.

Figure 1. The definition of response time

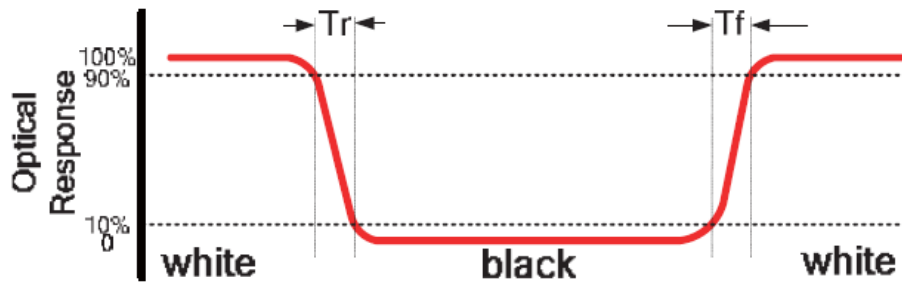
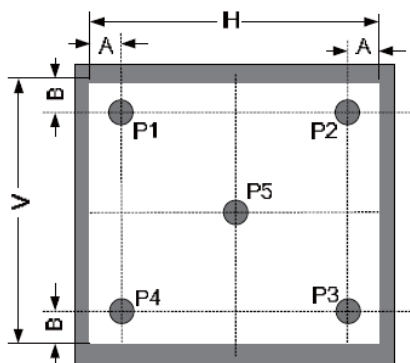
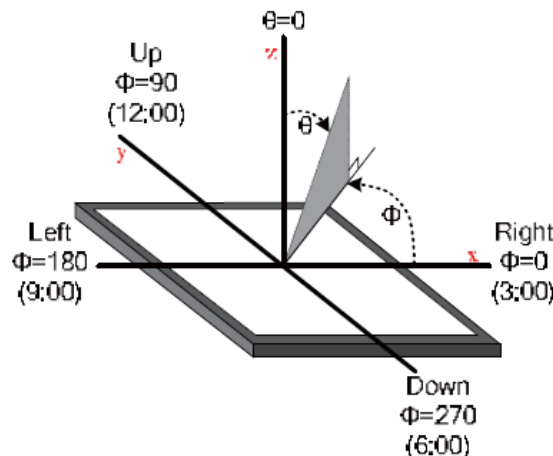

Figure 2. Measuring method for Contrast ratio, surface luminance, Luminance uniformity, CIE (x, y) chromaticity



A: 5mm
 B: 5mm
 H, V: Active Area
 Light spot size $\phi=5\text{mm}$, 500mm distance from the LCD surface to detector lens.
 Measurement instrument is TOPCON'S luminance meter BM-5

Figure 3. The definition of viewing angle





9. INTERFACE DESCRIPTION

9.1 TFT assignment

PIN NO.	SYMBOL	I/O	DESCRIPTION	NOTE
1	NC	-	No connection	
2	VDD	P	Power supply 3.3V	
3	VDD	P	Power supply 3.3V	
4	NC	-	No connection	
5	RESET	I	Global reset pin. Active low to enter reset state.	NOTE 1
6	STBYB	I	Internally pull-up, STBYB=1, normal operation. STBYB=0, timing control, source driver will turn off	
7	GND	P	Ground	
8	D0N	I/O	Negative MIPI differential data input	
9	D0P	I/O	Positive MIPI differential data input	
10	GND	P	Ground	
11	D1N	I/O	Negative MIPI differential data input	
12	D1P	I/O	Positive MIPI differential data input	
13	GND	P	Ground	
14	D2N	I/O	Negative MIPI differential data input	
15	D2P	I/O	Positive MIPI differential data input	
16	GND	P	Ground	
17	DCLKN	I/O	Negative MIPI differential clock input	
18	DCLKP	I/O	Positive MIPI differential clock input	
19	GND	P	Ground	
20	D3N	I/O	Negative MIPI differential data input	
21	D3P	I/O	Positive MIPI differential data input	
22	GND	P	Ground	
23	NC	-	No connection	
24	NC	-	No connection	
25	GND	P	Ground	
26	NC	-	No connection	
27	NC	-	No connection	
28	NC	-	No connection	
29	NC	-	No connection	
30	GND	P	Ground	
31	LED-	P	LED Cathode	
32	LED-	P	LED Cathode	
33	L/R	I	Left/Right display control, internally pull-up	Note 2
34	U/D	I	Up/Down display control, internally pull down	
35	NC	-	No connection	
36	NC	-	No connection	
37	NC	-	No connection	
38	NC	-	No connection	
39	LED+	P	LED Anode	
40	LED+	P	LED Anode	

I: input, O: output, P: Power

Note 1: Recommended Reset circuit:

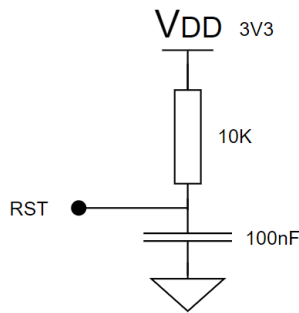

Note 2: U/D (Pin 34) is internally pull-down, and R/L (Pin 33) is internally pull-up. The default scanning direction is up to down, left to right.

SETTING OF SCAN CONTROL INPUT		SCANNING DIRECTION
U/D	L/R	
GND	VDD	Up to down, left to right
VDD	GND	Down to up, right to left
GND	GND	Up to down, right to left
VDD	VDD	Down to up, left to right

Definition of scanning direction, refer to the figure as below:

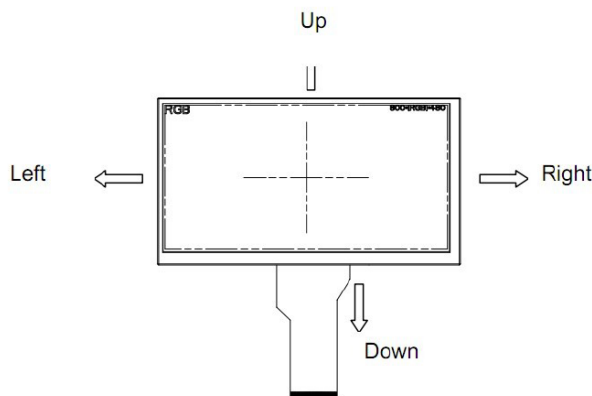

9.2 Touch panel assignment

PIN NO.	SYMBOL	DESCRIPTION	NOTE
1	USB_GND	USB_ Ground	
2	USB_VDD	USB Power for CTP, 5.0V	
3	USB_D-	USB _Data Signal -	
4	USB_D+	USB _Data Signal +	
5	I2C_GND	I2C _ Ground	
6	I2C_VDD	I2C _Power for CTP, 3.3 V	
7	I2C_RST	I2C _Reset Pin, Active low	Note 1
8	I2C_SCL	I2C _Clock Input	
9	I2C_INT	I2C _Interrupt Signal from CTP, Active low	
10	I2C_SDA	I2C _Data Signal	

Note 1. External pull-up resistors are required.



9.3 CON1 assignment

PIN NO.	SYMBOL	DESCRIPTION
1	USB_VDD	USB_Power for CTP, DC 5.0V
2	USB_D-	USB_Data Signal -
3	USB_D+	USB_Data Signal +
4	USB_GND	USB_Ground

10. TIMING CHARACTERISTICS

10.1 Low power transmitter AC characteristic

PARAMETER	SYMBOL	MIN	TYP	MAX	UNIT
15%~85% rising time and falling time	T_{RLP}/T_{FLP}	-	-	25	ns
30%~85% rising time and falling time	T_{REOT}	-	-	35	
Pulse width of LP exclusive -OR clock	First LP EXOR clock pulse after STOP state or LAST pulse before stop state	$T_{LP-PULSE-TX}$	40	-	
			All other pulses	20	-
Period of the LP EXOR clock	$T_{LP-PER-TX}$	90	-	-	mV/ns
Slew Rate @CLOAD =0pF	$\delta V / \delta t_{SR}$	30	-	500	
Slew Rate @CLOAD =5pF		30	-	200	
Slew Rate @CLOAD =20pF		30	-	150	
Slew Rate @CLOAD =70pF		30	-	100	
Load Capacitance	T_{RLP}	-	-	70	pF

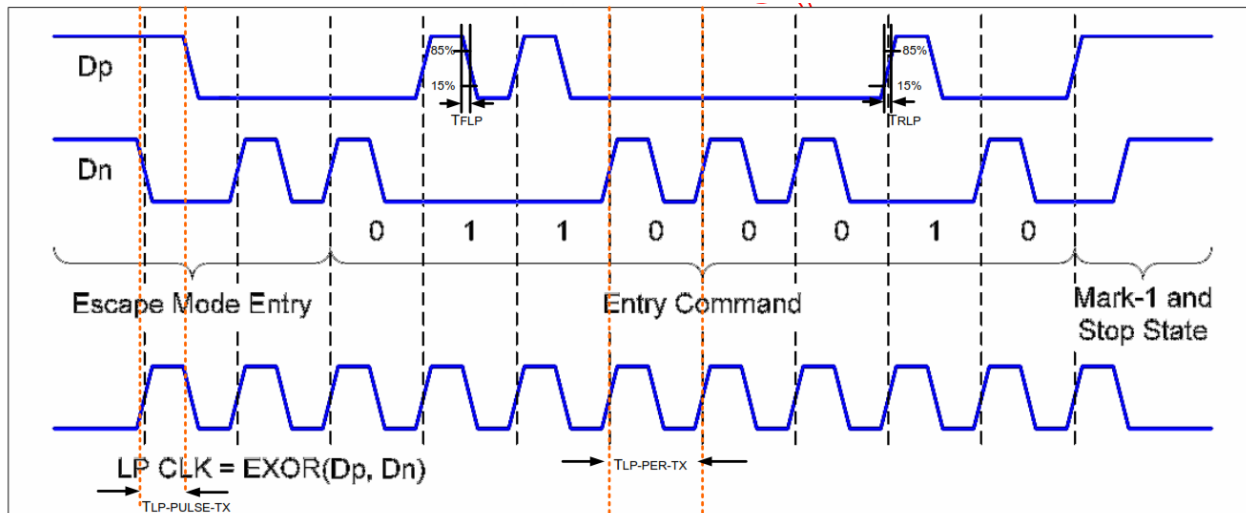



10.2 High speed transmission

PARAMETER	SYMBOL	MIN	TYP	MAX	UNIT
UI instantaneous	UI_{INST}	2	-	12.5	ns
Data to Clock Skew (measured at transmitter)	$T_{SKEW(TX)}$	-0.15	-	0.15	UI_{INST}
Data to Clock Setup time (Measured at receiver)	$T_{SETUP(RX)}$	0.15	-	-	
Data to Clock Hold time (Measured at receiver)	$T_{HOLD(RX)}$	0.15	-	-	
20%~80% rising time and falling time	T_R, T_F	150	-	-	ps
		-	-	0.3	UI_{INST}

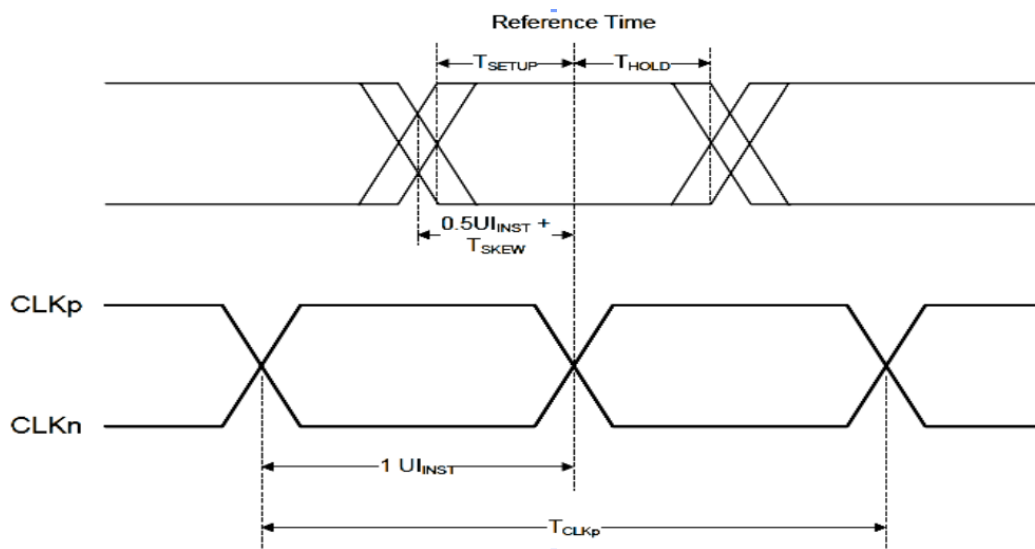



10.3 High speed clock transmission

PARAMETER	SYMBOL	MIN	TYP	MAX	UNIT
Time that the transmitter shall continue sending HS clock after the last associated Data Lane has transitioned to LP mode	$T_{CLK-POST}$	60+52UI	-	-	ns
Detection time that the clock has stopped toggling	$T_{CLK-MISS}$	-	-	60	
Time to drive LP-00 to prepare for HS clock transmission	$T_{CLK-PREPARE}$	38	-	95	
Minimum lead HS-0 drive period before starting clock	$T_{CLK-PREPARE+}$ $T_{CLK-ZERO}$	300	-	-	
Time to enable Clock Lane receiver line termination measured from when Dn cross $V_{IL,MAX}$	$T_{HS-TERM-EN}$	-	-	38	
Minimum time that the HS clock must be prior to any associated data lane beginning the transmission from LP to HS mode	$T_{CLK-PRE}$	8	-	-	UI
Time to drive HS differential state after last payload clock bit of a HS transmission burst	$T_{CLK-TRAIL}$	60	-	-	ns

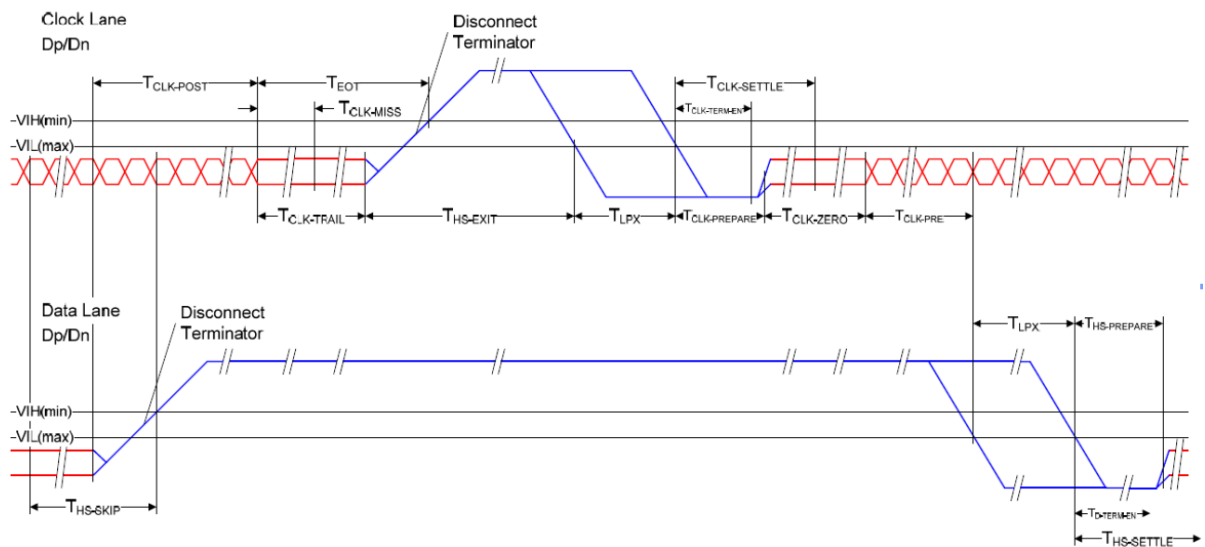



10.4 High speed data transmission in bursts

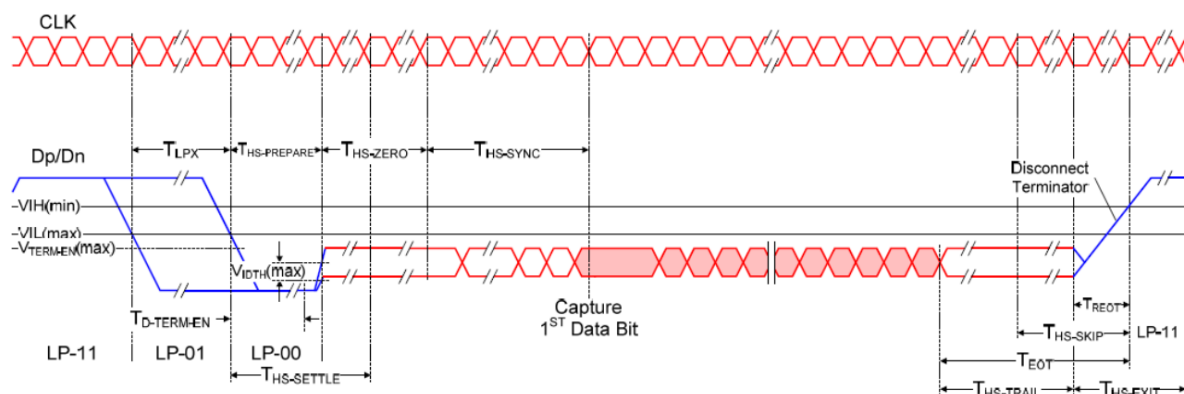

11. CAPACITIVE TOUCH SCREEN PANEL SPECIFICATIONS

11.1 Mechanical characteristics

DESCRIPTION	SPECIFICATION	REMARK
Touch Panel Size	7.0 inch	aTouch
Outline Dimension of CTP	164.70 mm x 99.80 mm	
Product Thickness	2.45 mm	
Glass Thickness	1.1 mm	
CTP View Area	155.01 mm x 86.72 mm	
Sensor Active Area	156.68 mm x 88.52 mm	
Structure type	Glass + Glass	
Surface Hardness	7H	

11.2 Electrical characteristics

PARAMETER	SPECIFICATION	REMARK	
Operating Voltage	DC 5.0 V (USB)	aTouch	
	DC 3.3 V (I2C)		
Power Consumption (IDD)	Active Mode		90 mA
	Sleep Mode		10 mA
Interface	USB / I2C /Optional UART		
Linearity	+/-1.5mm		
Controller	ILI2132A		
I2C address	0x82		
Resolution	1024 x 600		



12. INITIALIZATION CODE

```
DCS_Short_Write_NP(0x01); //Software Reset
Delay (120);
Generic_Short_Write_1P(0x87,0x5A);
//Other commands will not work if this command is not written
Generic_Short_Write_1P(0xB2,0x70); //Set Channels 2LANE:0x50; 3LANE:0x60; 4LANE:0x70
Generic_Short_Write_1P(0x80,0x4B); //Set Gamma voltage
Generic_Short_Write_1P(0x81,0xFF); //Set Gamma voltage
Generic_Short_Write_1P(0x82,0x1A); //Set Gamma voltage
Generic_Short_Write_1P(0x83,0x88); //Set Gamma voltage
Generic_Short_Write_1P(0x84,0x8F); //Set Gamma voltage
Generic_Short_Write_1P(0x85,0x35); //Set Gamma voltage
Generic_Short_Write_1P(0x86,0xB0); //Set Gamma voltage
DCS_Short_Write_NP(0x11); //Exit Sleep Mode
Delay (120);
DCS_Short_Write_NP(0x29); //Display on; 0x28 is display off
Delay (20);
```

13. INSPECTION

Standard acceptance/rejection criteria for TFT module

13.1 Inspection condition

Ambient conditions:

- Temperature: $25 \pm 2^{\circ}\text{C}$
- Humidity: $(60 \pm 10) \% \text{RH}$
- Illumination: Single fluorescent lamp non-directive (300 to 700 lux)

Viewing distance: $35 \pm 5\text{cm}$ between inspector bare eye and LCD.

Viewing Angle: U/D: $45^{\circ}/45^{\circ}$, L/R: $45^{\circ}/45^{\circ}$

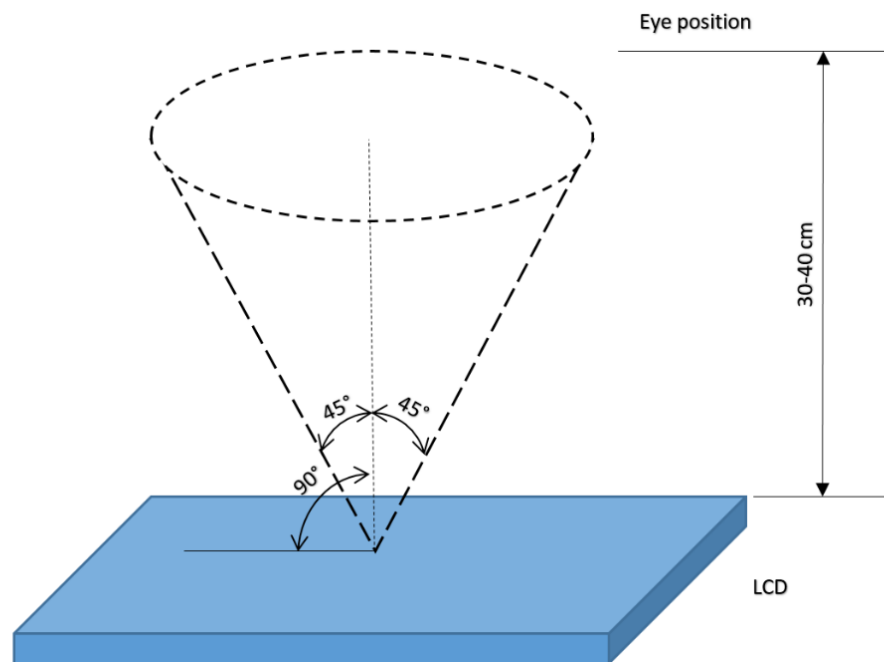

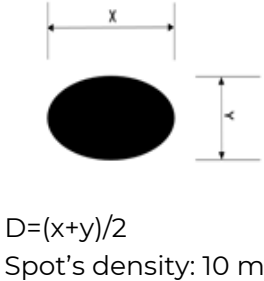
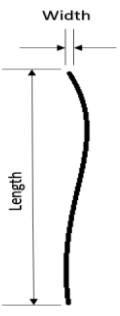

13.2 Inspection standard

ITEM		CRITERION		
Black spots, white spots, light leakage, Foreign Particle (round Type)	 <p>$D=(x+y)/2$ Spot's density: 10 mm</p>	Size = 7"		
		Average Diameter	Qualified Qty	
		$D \leq 0.2 \text{ mm}$	Ignored	
		$0.2 \text{ mm} < D \leq 0.3 \text{ mm}$	N≤3	
		$0.5\text{mm} < D$	Not allowed	
LCD black spots, white spots, light leakage (line Type)		Size = 7"		
		Length	Width	Qualified Qty
		-	$W \leq 0.05$	Ignored
		$L \leq 5.0$	$0.05 < W \leq 0.1$	3
Bright/Dark Dots	Size = 7"			
	Item	Qualified Qty		
	Bright dots	N≤2		
	Dark dots	N≤3		
Clear spots	Size = 7"			
	Average Diameter	Qualified Qty		
	$D < 0.2 \text{ mm}$	Ignored		
	$0.2 \text{ mm} < D < 0.3 \text{ mm}$	4		
	$0.3 \text{ mm} < D < 0.5 \text{ mm}$	2		
Polarizer bubbles	Size = 7"			
	Average Diameter	Qualified Qty		
	$D \leq 0.2 \text{ mm}$	Ignored		
	$0.2 \text{ mm} < D \leq 0.5 \text{ mm}$	4		
Touch panel spot	Size ≥ 5"			
	Average Diameter	Qualified Qty		
	$D < 0.25 \text{ mm}$	Ignored		
	$0.25 \text{ mm} < D < 0.5 \text{ mm}$	4		
Touch panel White line Scratch	Size ≥ 5"			
	Length	Width	Qualified Qty	
	-	$W < 0.03$	Ignored	
	$L < 5.0$	$0.03 < W < 0.05$	2	
-	$0.05 < W$	0		



14. RELIABILITY TEST

NO.	TEST ITEM	TEST CONDITION
1	High Temperature Storage	80°C/120 hours
2	Low Temperature Storage	-30°C/120 hours
3	High Temperature Operating	70 °C /120 hours
4	Low Temperature Operating	-20°C/120 hours
5	High Temperature and High Humidity	Humidity 40°C, 90%RH, 120Hrs
6	Thermal Cycling Test (No operation)	-20°C for 30min, 70°C for 30 min. 100 cycles. Then test at room temperature after 1 hour
7	Vibration Test	Frequency: 10 ÷ 55 Hz. Stroke: 1.5 mm. Sweep: 10Hz ÷ 55Hz ÷ 10 Hz. 2 hours for each direction of X, Y, Z (Total 6 hours)
8	Package Drop Test	Height: 60 cm 1 corner, 3 edges, 6 surfaces
9	ESD Test	Air: ±2 kV, Human Body Mode, 100 pF /1500 Ω

Note 1. Sample quantity for each test item is 5 ÷ 10 pcs.

Note 2. Before cosmetic and function test, the product must have enough recovery time, at least 2 hours at room temperature.



15. LEGAL INFORMATION

Riverdi grants the guarantee for the proper operation of the goods for a period of 12 months from the date of possession of the goods. If in a consequence of this guaranteed execution the customer has received the defects-free item as replacement for the defective item, the effectiveness period of this guarantee shall start anew from the moment the customer receives the defects-free item.

Information about device is the property of Riverdi and may be the subject of patents pending or granted. It is not allowed to copy or disclosed this document without prior written permission.

Riverdi endeavors to ensure that all contained information in this document is correct but does not accept liability for any error or omission. Riverdi products are in developing process and published information may be not up to date. Riverdi reserves the right to update and makes changes to Specifications or written material without prior notice at any time. It is important to check the current position with Riverdi.

Images and graphics used in this document are only for illustrative the purpose. All images and graphics are possible to be displayed on the range products of Riverdi, however the quality may vary. Riverdi is no liable to the buyer or to any third party for any indirect, incidental, special, consequential, punitive or exemplary damages (including without limitation lost profits, lost savings, or loss of business opportunity) relating to any product, service provided or to be provided by Riverdi, or the use or inability to use the same, even if Riverdi has been advised of the possibility of such damages.

Riverdi products are not fault tolerant nor designed, manufactured or intended for use or resale as on line control equipment in hazardous environments requiring fail-safe performance, such as in the operation of nuclear facilities, aircraft navigation or communication systems, air traffic control, direct life support machines or weapons systems in which the failure of the product could lead directly to death, personal injury or severe physical or environmental damage ('High-Risk Activities'). Riverdi and its suppliers specifically disclaim any expressed or implied warranty of fitness for High-Risk Activities. Using Riverdi products and devices in 'High-Risk Activities' and in any other application is entirely at the buyer's risk, and the buyer agrees to defend, indemnify and hold harmless Riverdi from all damages, claims or expenses resulting from such use. No licenses are conveyed, implicitly or otherwise, under any Riverdi intellectual property rights.

Hi, I am here to help you!
If you have any additional
questions, please contact
our support via email:
contact@riverdi.com



X-ON Electronics

Largest Supplier of Electrical and Electronic Components

Click to view similar products for [TFT Displays & Accessories](#) category:

Click to view products by [Riverdi](#) manufacturer:

Other Similar products are found below :

[F3ET2-005-150](#) [HDA430T-3G1H](#) [NB7W-KBA04](#) [NB-ATT01](#) [NB5Q-ATT01](#) [NB5Q-KBA04](#) [NB-CN001](#) [OAI-80038AA-2008-A](#) [315-U004B15300](#) [TCG121WXLRXVNNANX35](#) [EIC-LCD-1080P](#) [T-55619GD065J-LW-ABN](#) [NLB150XG02L-01](#) [NL192108AC10-01D](#) [NL6448AC18-08F](#) [NL8060BC26-35BA](#) [NL6448BC26-26D](#) [NL8060BC31-50F](#) [TM070DDHG03-40](#) [PTPW16-070WV1S02](#) [PTPW16-084SV1S02](#) [MTD0300ECP06DF-1](#) [4DLCD-35480320-CTP-IPS](#) [4DLCD-35480320-IPS](#) [4DLCD-35480320-RTP-IPS](#) [4DLCD-50800480-CTP-IPS](#) [RFA6400E-AWH-DNG](#) [RFE430V-AZW-DNS](#) [RFF70BQ-1IW-DBG](#) [RFF70VA2-1IW-DHS](#) [RFH700A8-AYH-MNN](#) [RFK101VF-1YH-LHG](#) [RFS52VA-1ZH-DHN](#) [SM-RVT101HVHFWN00](#) [SM-RVT101HVHNWC00](#) [SM-RVT101HVHNWCA0](#) [SM-RVT101HVHNWN00](#) [SM-RVT101HVLFWCA0](#) [SM-RVT101HVLNWCA0](#) [SM-RVT35HHTFWCA0](#) [SM-RVT35HHTNWCA0](#) [SM-RVT43HLTFWCA0](#) [SM-RVT43HLTNWCA0](#) [SM-RVT50HQTFWCA0](#) [SM-RVT50HQTNWCA0](#) [SM-RVT70AQLFWR00](#) [SM-RVT70AQLNWR00](#) [SM-RVT70HSLFWCA0](#) [SM-RVT70HSMFWCA0](#) [SM-RVT70HSMFWN00](#)