

Rockchip RK860 Datasheet

Revision History

Date	Revision	Description
2021-10-11	1.2	Update RK860-3 description
2021-6-23	1.1	Update Thermal Management information
2021-5-11	1.0	Initial release

Warranty Disclaimer

Rockchip Electronics Co.,Ltd makes no warranty, representation or guarantee (expressed, implied, statutory, or otherwise) by or with respect to anything in this document, and shall not be liable for any implied warranties of non-infringement, merchantability or fitness for a particular purpose or for any indirect, special or consequential damages.

Information furnished is believed to be accurate and reliable. However, Rockchip Electronics Co., Ltd assumes no responsibility for the consequences of use of such information or for any infringement of patents or other rights of third parties that may result from its use.

Rockchip Electronics Co.,Ltd's products are not designed, intended, or authorized for using as components in systems intended for surgical implant into the body, or other applications intended to support or sustain life, or for any other application in which the failure of the Rockchip Electronics Co.,Ltd's product could create a situation where personal injury or death may occur, should buyer purchase or use Rockchip Electronics Co.,Ltd's products for any such unintended or unauthorized application, buyers shall indemnify and hold Rockchip Electronics Co.,Ltd and its officers, employees, subsidiaries, affiliates, and distributors harmless against all claims, costs, damages, expenses, and reasonable attorney fees arising out of, either directly or indirectly, any claim of personal injury or death that may be associated with such unintended or unauthorized use, even if such claim alleges that Rockchip Electronics Co.,Ltd was negligent regarding the design or manufacture of the part.

Copyright and Patent Right

Information in this document is provided solely to enable system and software implementers to use Rockchip Electronics Co., Ltd 's products. There are no expressed or implied copyright licenses granted hereunder to design or fabricate any integrated circuits or integrated circuits based on the information in this document.

Rockchip Electronics Co.,Ltd does not convey any license under its patent rights nor the rights of others.

All copyright and patent rights referenced in this document belong to their respective owners and shall be subject to corresponding copyright and patent licensing requirements.

Trademarks

Rockchip and Rockchip™ logo and the name of Rockchip Electronics Co.,Ltd's products are trademarks of Rockchip Electronics Co.,Ltd. and are exclusively owned by Rockchip Electronics Co.,Ltd. References to other companies and their products use trademarks owned by the respective companies and are for reference purpose only.

Confidentiality

The information contained herein (including any attachments) is confidential. The recipient hereby acknowledges the confidentiality of this document, and except for the specific purpose, this document shall not be disclosed to any third party.

Reverse engineering or disassembly is prohibited.

ROCKCHIP ELECTRONICS CO.,LTD. RESERVES THE RIGHT TO MAKE CHANGES IN ITS PRODUCTS OR PRODUCT SPECIFICATIONS WITH THE INTENT TO IMPROVE FUNCTION OR DESIGN AT ANY TIME AND WITHOUT NOTICE AND IS NOT REQUIRED TO UNDATE THIS DOCUMENTATION TO REFLECT SUCH CHANGES.

Copyright © 2021 Rockchip Electronics Co.,Ltd.

All rights reserved. No part of this publication may be reproduced, stored in a retrieval system, or transmitted in any form or by any means, electric or mechanical, by photocopying, recording, or otherwise, without the prior written consent of Rockchip Electronics Co.,Ltd.

Chapter 1 Introduction

1.1 Overview

The RK860 is a high efficiency 2.4MHz synchronous step down DC/DC regulator IC capable of delivering up to 6A output current. It can operate over a wide input voltage range from 2.7V to 5.5V. And, it integrates a main switch and a synchronous switch with both very low $R_{DS(ON)}$ to minimize the conduction loss. The output voltage can be programmed from 0.7125V to 1.5V with 12.5mV/step or 0.5V to 1.5V with 6.25mV/step through I²C interface.

The RK860 is in a space saving, low profile WLCSP 1.65mm*2.05mm-20 package.

1.2 Feature

- Input voltage range: 2.7V-5.5V
- 2.4MHz switching frequency minimizes the external components
- Typical 70uA quiescent current when $V_{IN}=3.8V$ and $Temp=25^{\circ}C$
- Low $R_{DS(ON)}$ for internal switches(PFET/NFET):24mohm/16ohm @ $V_{IN}=3.8V$
- Programmable output voltage:0.7125V to 1.5V with 12.5mV/step or 0.5V to 1.5V with 6.25mV/step
- 6A continuous output current capability
- Capable for 0.24uH inductor and 22uF*2 ceramic capacitor
- Hic-cup mode protection for hard short condition
- Integrate inner protection: Cycle by cycle OCP and V_{IN} -OVP/UVLO/DIE-TSD
- RoHS compliant and Halogen free
- Compact package: WLCSP 1.65*2.05-20

1.3 Typical Application Diagrams

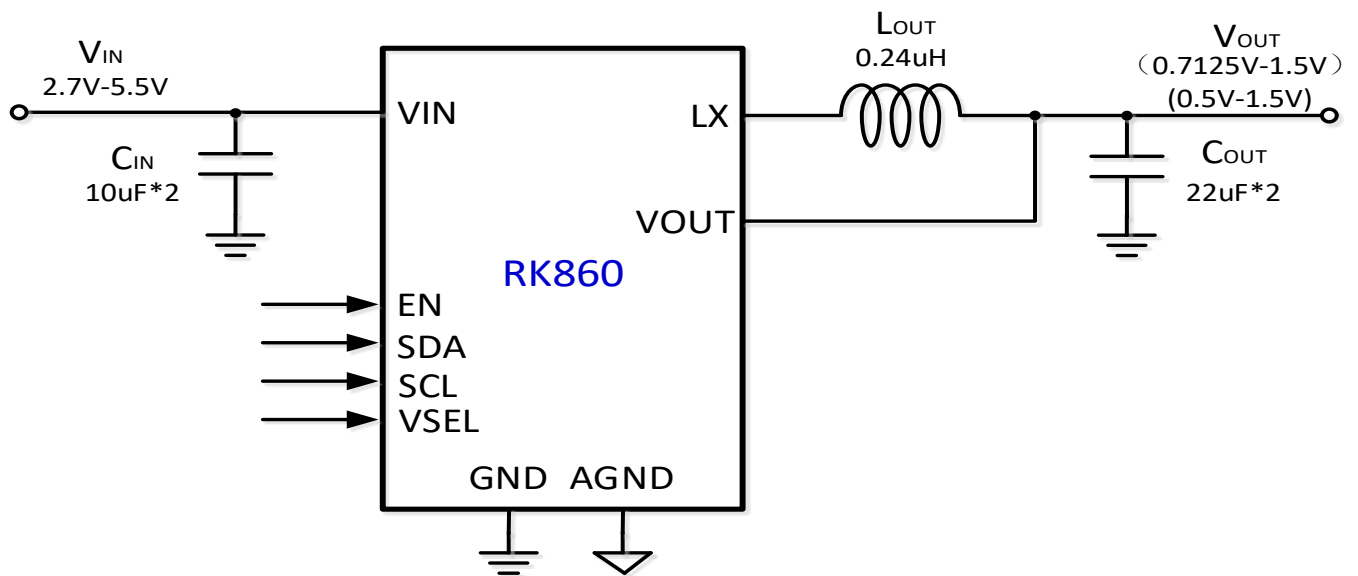

Fig. 1-1 RK860 Application

1.4 Pin Assignment

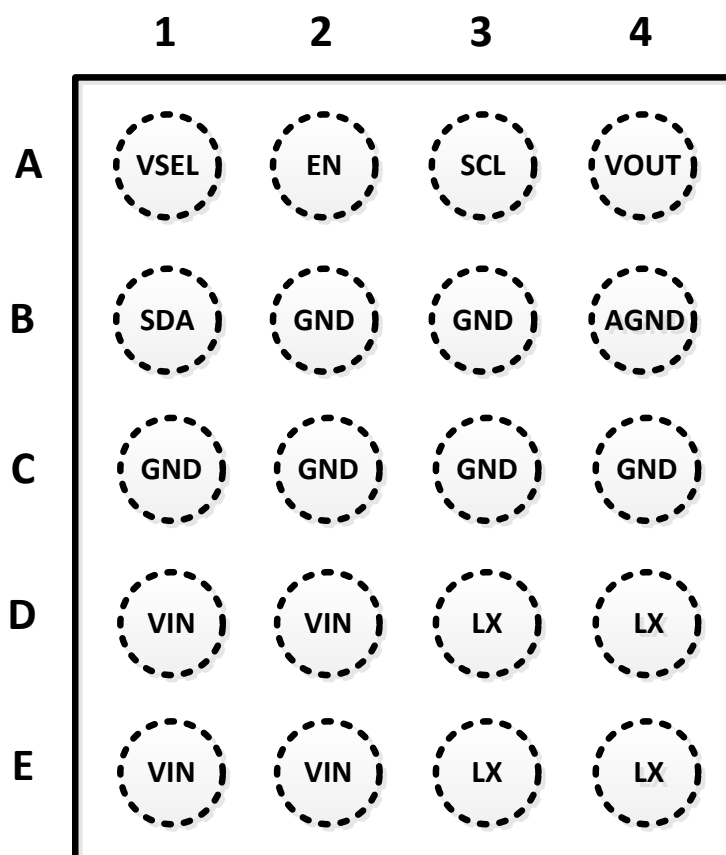

Fig. 1-2 Pin Assignment (Top view)

1.5 Pinout Number Order

Number	Name	Function	I/O
D1,D2,E1,E2	VIN	Power input pins. These pins must be decoupled to ground by 2 10uF ceramic capacitor as input filter at least. The input capacitor should be placed as close as possible between VIN and GND pins.	Power
D3,D4,E3,E4	LX	Switching node pin. Connect these pins to switching node of inductor.	Output
B2,B3,C1,C2,C3,C4	GND	Power ground pins.	Ground
B4	AGND	Analog ground pin.	
A1	VSEL	Voltage select pin. When this pin is low, V _{OUT} is set by the VSEL0 register. When this pin is high, V _{OUT} is set by the VSEL1 register.	Input
A2	EN	Enable control pin. Active high. Do not leave it floating.	Input
A3	SCL	I ² C interface clock line.	Input
B1	SDA	I ² C interface Bi-directional Data line. (Open drain)	I/O
A4	VOUT	Sense pin for output. Connect to the output capacitor side	Output

Chapter 2 Electrical Characteristics

Note 1. Stresses beyond the "Absolute Maximum Ratings" may cause permanent damage to the device. These are stress ratings only. Functional operation of the device at these or any other conditions beyond those indicated in the operational sections of the specification is not implied. Exposure to absolute maximum rating conditions for extended periods may affect device reliability.

Note 2: The device is not guaranteed to function outside its operating conditions.

3.1 Absolute Maximum Ratings(Note 1)

Parameter	Value	Units
Voltage range on pins VIN:	6.0	V
Voltage range on other pins	VIN+0.6	V
Continuous power dissipation, PD @ TA=25°C, WCSP4*5-20	0.5	W
Junction temperature range, T _j	-40~150	°C
Lead Temperature(soldering 10 sec), T _{SOLDER}	260	°C
Storage temperature range, T _s	-65~150	°C
ESD Susceptibility		
ESD HBM	2000	V
ESD CDM	1000	V

3.2 Recommended Operating Conditions(Note 2)

Parameter	Symbol	value	Units
Supply Input Voltage	V _{IN}	2.7~5.5	V
Output Voltage	V _{OUT}	0.5~1.5	V
Inductor	L	0.22~0.47	uH
Input Capacitor	C _{IN}	>10	uF
Output Capacitor	C _{OUT}	44~88	uF
Junction temperature range	T _j	-40~125	°C
Ambient temperature range	T _a	-40~85	°C

3.3 Electrical Characteristics

(With typical application circuit shown in below part, V_{IN}=3.8V, V_{OUT}=1.0V, L=0.24uH, C_{OUT}=22uF*2, T_A=25°C unless otherwise specified.)

PARAMETERS	SYMBOL	Note	MIN	TYP	MAX	UNIT
The UVLO threshold voltage of VIN	V _{IN_UVLO}	Vin rising		2.55	2.65	V
The UVLO Hysteresis voltage of VIN	V _{IN_UVLO_HYS}	Vin falling		150		mV
The OVP threshold voltage of VIN	V _{IN_OV}	Vin rising		6		V
The OVP Hysteresis voltage of VIN	V _{IN_OV_HYS}	Vin falling		200		mV
Quiescent Current	I _q	No switching, vfb=105%Vref.		70		uA
Shutdown current	I _{sd}	EN=L		0.1		uA
Software shutdown current	I _{sd_soft}	EN=H, BUCK_EN=L		25		uA
Internal soft-start time	T _{ss}	Vout=1.0V, from BUCK_EN rising edge to Vout>92%.		260		uS

PARAMETERS	SYMBOL	Note	MIN	TYP	MAX	UNIT
Oscillator Frequency	Fclk	PWM mode or FPWM mode	2.2	2.4	2.6	MHz
Discharge resistance	Rdisc	EN=L/BUCK_EN=0		150		Ω
Input logic high threshold of signal (EN/VSEL)	VIH		1.1			V
	VIL				0.4	V
Input logic high threshold of signal (SDA/SCL)	VIH		1.26			V
	VIL				0.54	V
Vout Accuracy when FPWM	V _{REG1} (The output Voltage error)	Forced PWM, VOUT=1.0V	-0.6		+0.6	%
Vout Accuracy when PFM	V _{REG2} (The output Voltage error)	Auto PFM, VOUT=1.0V	-1.5		1.5	%
PMOS RDS(ON)	RDS(ON)P	VIN PIN to LX PIN, VIN=3.8V		24		mΩ
NMOS RDS(ON)	RDS(ON)N	LX PIN to GND PIN, VIN=3.8V		16		mΩ
Maximum current of PMOS	Ipeak		7.5			A
Maximum current of NMOS	Ivalley		6.0			A
Thermal shutdown temperature	TSD	Rising TSD threshold		150		°C
Thermal shutdown Hysteresis	TSD_HYS			25		°C

Chapter 3 Chip Version Description

DIE-ID	I2C-ADDR (7-bit)	Vout Range/V	Default Vout/V	STEP/ mV	DIE_ID
RK860-0	40H	0.7125-1.5	1.0	12.5	0X8
RK860-1	41H	0.7125-1.5	1.0	12.5	0X8
RK860-2	42H	0.5-1.5	0.8	6.25	0XA
RK860-3	43H	0.5-1.5	0.8	6.25	0XA

Chapter 4 Register Description

VSEL0_A

Address: (0x00)

Bit	Attr	Reset Value	Description
7	RW	0x1	BUCK_EN0: Software buck enable. 1:enable BUCK work; 0:shut off BUCK (When external EN pin is low. The regulator is off. When external EN pin is high, BUCK_EN bit takes precedent.)
6	RW	0x0	MODE0: 0=Allow auto-PFM mode during light load 1=Forced PWM mode
5:0	RW	0x17	NSEL0 : 12.5mV/step (just for DIE_ID=0X8) 000000=0.7125V; 000001=0.7250V; 000010=0.7375V; 010111=1.0000V; 111111=1.5V;

VSEL1_A

Address: (0x01)

Bit	Attr	Reset Value	Description
7	RW	0x1	BUCK_EN1: Software buck enable. 1:enable BUCK-LOOP work; 0:shut off BUCK-LOOP (When external EN pin is low. The regulator is off. When external EN pin is high, BUCK_EN bit takes precedent.)
6	RW	0x0	MODE1: 0=Allow auto-PFM mode during light load 1=Forced PWM mode
5:0	RW	0x17	NSEL1 : 12.5mV/step (just for DIE_ID=0X8) 000000=0.7125V; 000001=0.7250V; 000010=0.7375V; 010111=1.0000V; 111111=1.5V;

Control_Register

Address: (0x02)

Bit	Attr	Reset Value	Description
7	RW	0x1	Output Discharge: 0=discharge resistor is disabled. 1=discharge resistor is enabled.
6:4	RW	0x0	Slew Rate: Set the slew rate for positive voltage transitions. 000 = 10mV/0.15us 001 = 10mV/0.3us 010 = 10mV/0.6us 011 = 10mV/1.2us 100 = 10mV/2.4us 101 = 10mV/4.8us 110 = 10mV/9.6us 111 = 10mV/19.2us
3:0	RW	0x0	Always reads back 0. RESET: Setting to 1 resets all registers to default values.

ID1 Register

Address: (0x03)

Bit	Attr	Reset Value	Description
7:5	R	0x4	VENDOR: IC vendor Rockchip code.
4	R	0x0	Reserved: Always reads back 0.
3:0	R	0x8/0xA	DIE_ID: 0x8: Output Voltage from 0.7125V to 1.5V with 12.5mV/step 0xA: Output Voltage from 0.5V to 1.5V with 6.25mV/step

ID2 Register

Address: (0x04)

Bit	Attr	Reset Value	Description
7:4	R	0x0	Reserved: Always reads back 0.
3:0	R	NA	NA

PGOOD Register

Address: (0x05)

Bit	Attr	Reset Value	Description
7	R	0x0	PGOOD: 1: Buck is enabled and soft-start is completed. (Vout>92% normal set-value) 0: Vout is abnormal

Bit	Attr	Reset Value	Description
6	R	0x0	TSD: thermal shut down BUCK. 1: Tdie>150'C, 0: Tdie<125'C
5	R	0x0	IOVP: Over input voltage shut-off protection state. 1: VIN>6V, 0: VIN<5.8V
4	R	0x0	UVLO: Input voltage under-lock state. 1: VIN<2.4V, 0:VIN>2.55V
3:0	R	0x0	Reserved

VSEL0_B Register

Address: (0x06)

Bit	Attr	Reset Value	Description
7:0	R/W	0x30	NSEL0: when VSEL=L option just for DIE_ID=0XA 00,000,000 = 0.5V 00,000,001 = 0.50625V 00,000,010 = 0.51250V 00,110,000 = 0.8V 10,100,000 =1.5V >10,100,000=1.5V

VSEL1_B Register

Address: (0x07)

Bit	Attr	Reset Value	Description
7:0	R/W	0x30	NSEL1: when VSEL=H option just for DIE_ID=0XA 00,000,000 = 0.5V 00,000,001 = 0.50625V 00,000,010 = 0.51250V 00,110,000 = 0.8V 10,100,000 =1.5V >10,100,000=1.5V

Chapter 5 Typical Performance Characteristics

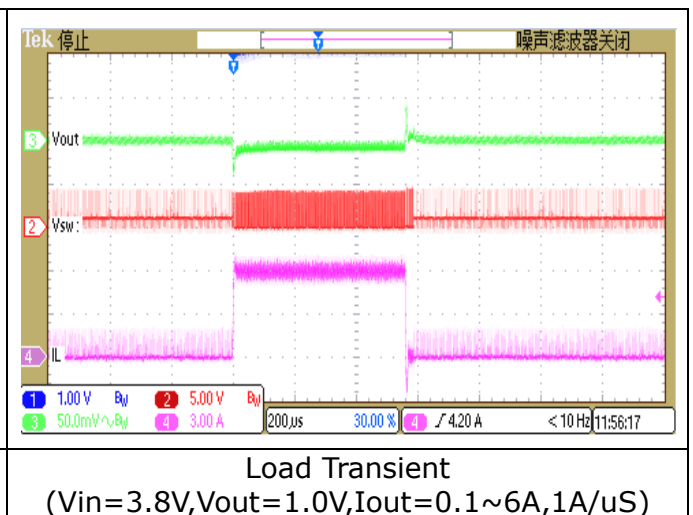
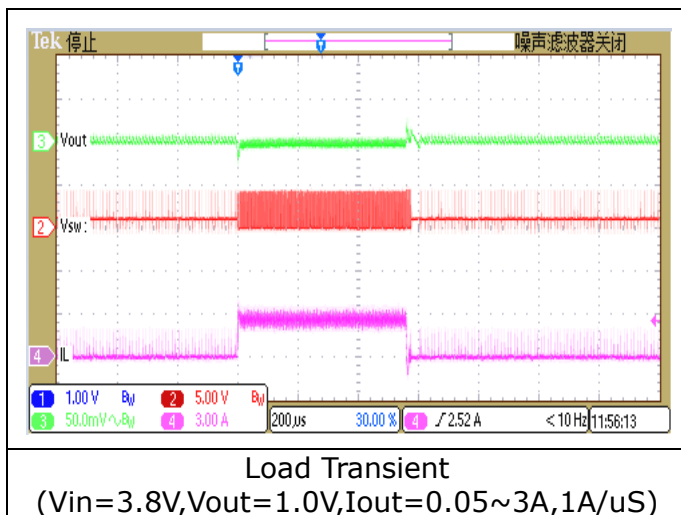
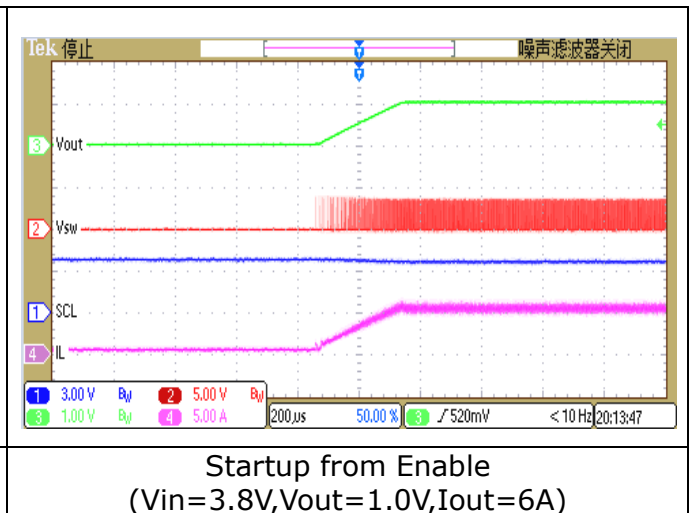
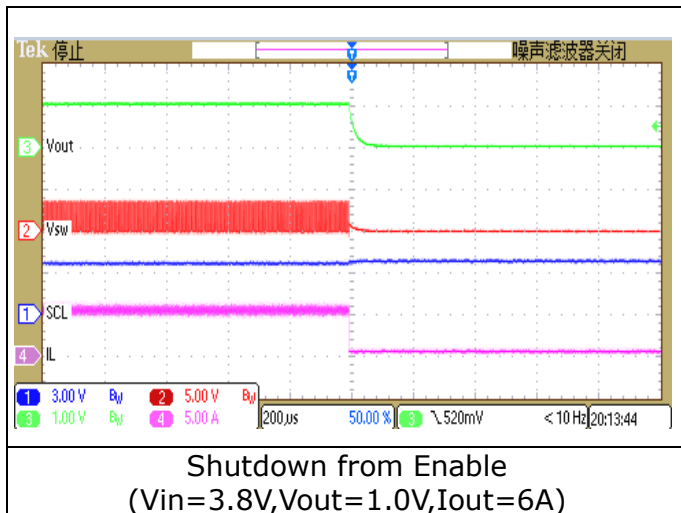
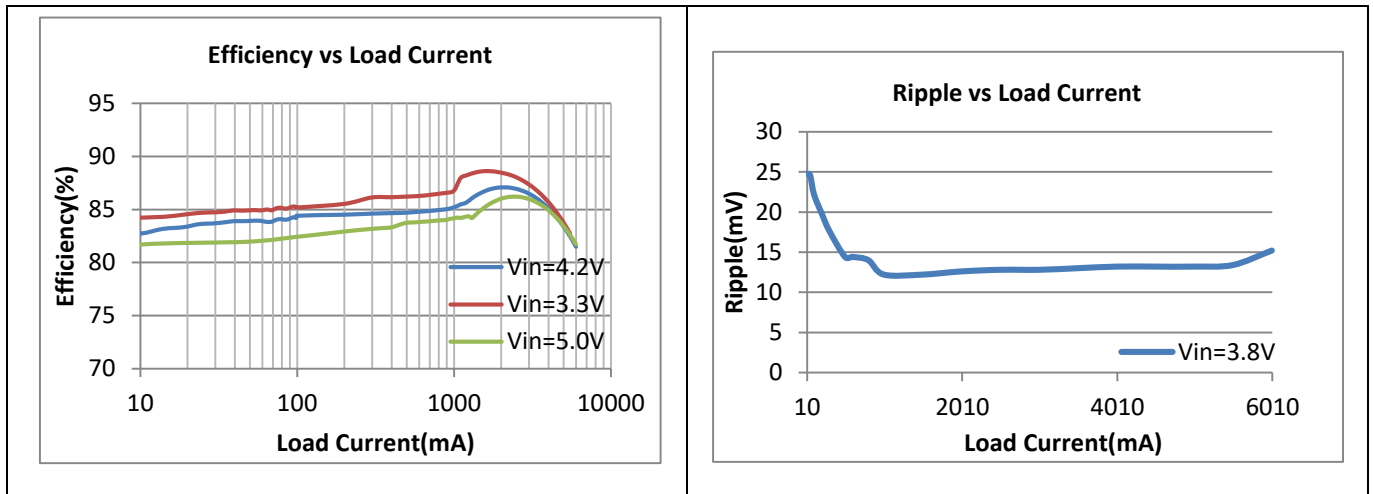

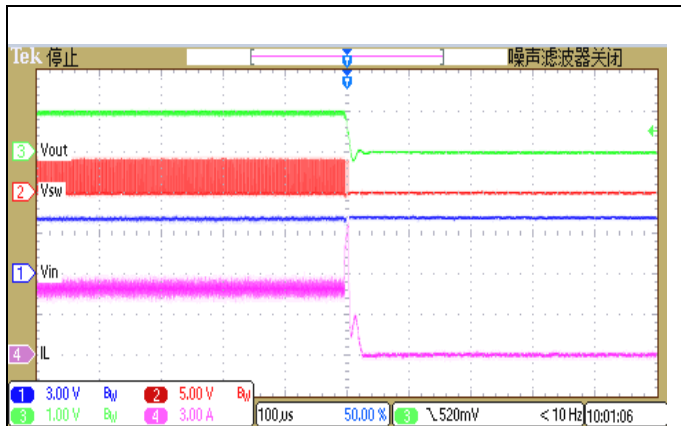

Short Circuit Protection
($V_{in}=3.8V, V_{out}=1.0V, I_{out}=6A \sim \text{short}$)

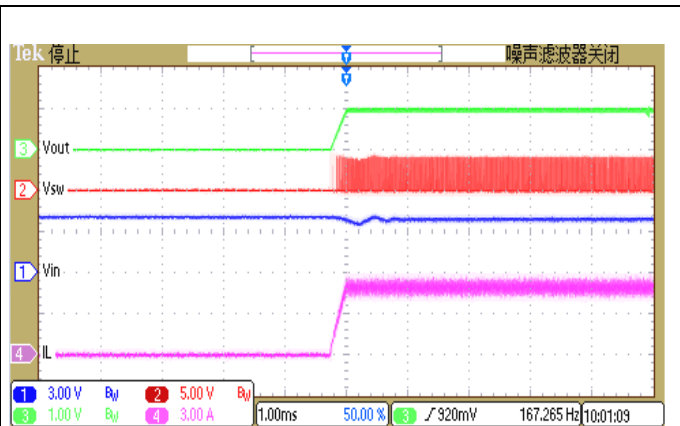

Short Circuit Protection
($V_{in}=3.8V, V_{out}=1.0V, I_{out}=\text{short} \sim 6A$)

Chapter 6 Package information

6.1 Ordering information

Orderable Device	Device Mark	RoHS status	Package	Package Qty
RK860-0	D0	RoHS pass	WLCSP20(pitch 0.4mm)	5000 pcs/tape
RK860-1	D1	RoHS pass	WLCSP20(pitch 0.4mm)	5000 pcs/tape
RK860-2	D2	RoHS pass	WLCSP20(pitch 0.4mm)	5000 pcs/tape
RK860-3	D3	RoHS pass	WLCSP20(pitch 0.4mm)	5000 pcs/tape

6.2 Top Marking

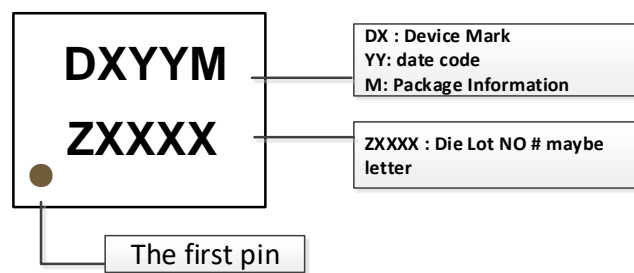

6.3 Dimension

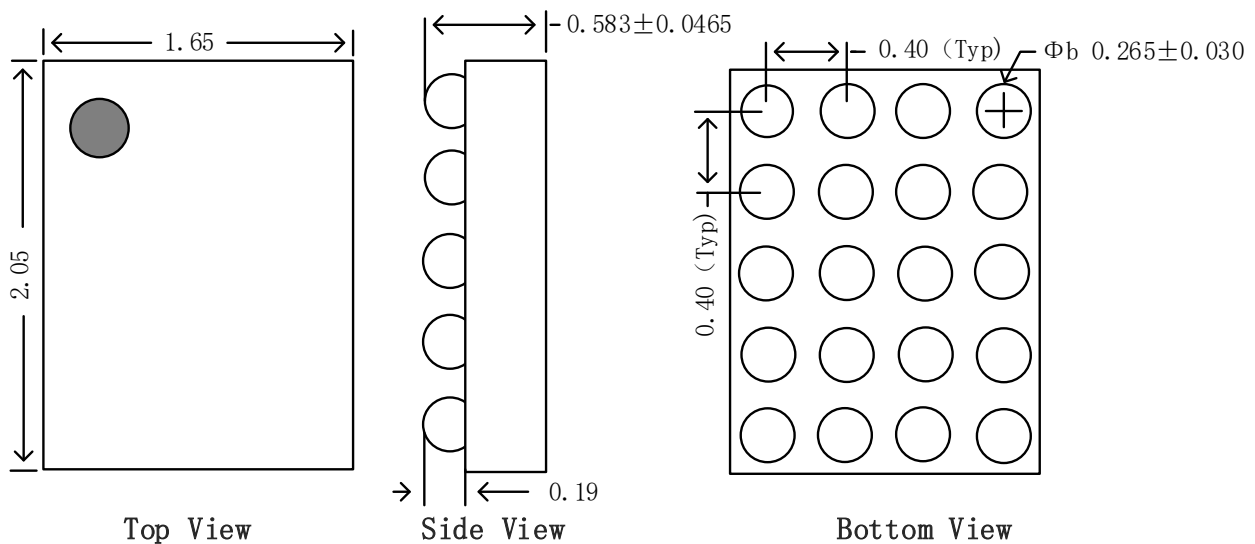

Notes: All dimension in MM

Fig. 6-1 WLCSP20 (Pitch is 0.4mm)

Note:

- Coplanarity applies to leads, corner leads and die attach pad.
- Dimension ϕb applies to metalized terminal and is measured between 0.15mm and 0.30mm from the terminal tip. If the terminal has the optional radius on the other end of the terminal, the dimension ϕb should not be measure in that radius area.
- 0.15mm of dimension ϕb is recommended in PCB layout.

Chapter 7 Thermal Management

7.1 Overview

For reliability and operability concerns, the absolute maximum junction temperature of RK860 has to be below 150°C.

Depending on the thermal mechanical design (Smartphone, Tablet, Personal Navigation Device, etc), the system thermal management software and worst case thermal applications, the junction temperature might be exposed to higher values than those specified above.

Therefore, it is recommended to perform thermal simulations at device level (Smartphone, Tablet, Personal Navigation Device, etc) with the measured power of the worst case UC of the device.

7.2 Package Thermal Characteristics

Table 5-1 provides the thermal resistance characteristics for the package used on this device.

Table 7-1 Thermal Resistance Characteristics

PACKAGE (WLCSP20)	Continuous power dissipation, PD @ T _A =25°C,WCSPP4*5- 20(W)	θ _{JA} , 2-layer PCB Thermal resistance from junction to ambient θ _{JA} (°C/W)	θ _{JC} , 2-layer PCB Thermal resistance from junction to component θ _{JC} (°C/W)
RK860	0.5	64.44	17.76

X-ON Electronics

Largest Supplier of Electrical and Electronic Components

Click to view similar products for [Switching Controllers](#) category:

Click to view products by [Rockchip](#) manufacturer:

Other Similar products are found below :

[NCP1218AD65R2G](#) [NCP1244BD065R2G](#) [NCP6153MNTWG](#) [NCP81101BMNTXG](#) [NCP81205MNTXG](#) [SJE6600](#) [SG3845DM](#)
[NCP4204MNTXG](#) [NCP6132AMNR2G](#) [NCP81102MNTXG](#) [NCP81206MNTXG](#) [MAX1653ESET](#) [NCP1240FD065R2G](#)
[NCP1361BABAYSNT1G](#) [NCP1230P100G](#) [NX2124CSTR](#) [NCP1366BABAYDR2G](#) [NCP81174NMNTXG](#) [NCP4308DMTTWG](#)
[NCP4308AMTTWG](#) [NCP1366AABAYDR2G](#) [NCP1251FSN65T1G](#) [NCP1246BLD065R2G](#) [NTE7233](#) [ISL69122IRAZ](#) [MB39A136PFT-G-](#)
[BND-ERE1](#) [NCP1256BSN100T1G](#) [LV5768V-A-TLM-E](#) [NCP1365BABCYDR2G](#) [NCP1365AABCYDR2G](#) [NCP1246ALD065R2G](#)
[AZ494AP-E1](#) [CR1510-10](#) [NCP4205MNTXG](#) [XC9221C093MR-G](#) [XRP6141ELTR-F](#) [RY8017](#) [LP6260SQVF](#) [LP6298QVF](#) [ISL6121LIB](#)
[ISL6225CA](#) [ISL6244HRZ](#) [ISL6268CAZ](#) [ISL6315IRZ](#) [ISL6420AIAZ-TK](#) [ISL6420AIRZ](#) [ISL6420IAZ](#) [ISL6421ERZ](#) [ISL6440IA](#)
[ISL6441IRZ-TK](#)