

# BTSA Series Push Switches

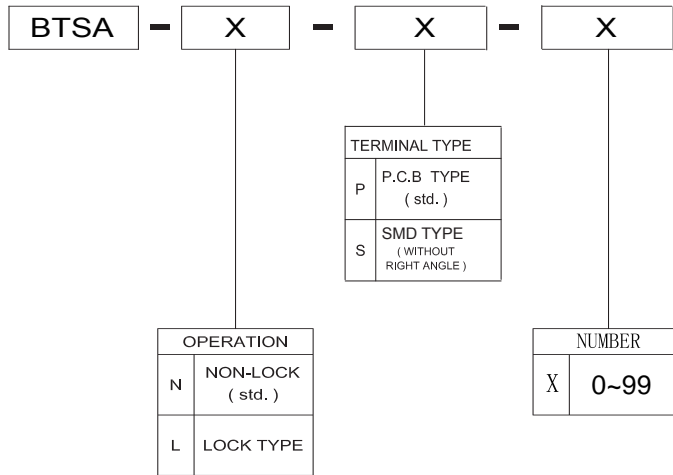

**SPECIFICATIONS**

SWITCH SPECIFICATIONS	
POLE - POSITION	SPDT , DPDT
CONTACT RATING	12 V DC , 50 mA
CONTACT RESISTANCE	100 mΩ MAX, 1.5 V DC; 100 mA, by Method of Voltage DROP
INSULATION RESISTANCE	100 MΩ MIN, 500 V DC for 1 minute
DIELECTRIC STRENGTH	Breakdown Is not Allowable ; 500 V AC for 1 Minute
OPERATING FORCE	250 ± 50 gf
OPERATING LIFE	10,000 cycles
OPERATING TEMPERATURE RANGE	-20°C ~ 70°C
TOTAL TRAVEL / OPERATING TRAVEL	2 ± 0.3 mm / 1.3 ± 0.3 mm

## Materials

- KNOB: POM Natural
- HOUSING: PA Black
- COVER: PC Grey
- TERMINAL: Bras, silver plated
- CONTACT CLIP: Phosphor bronze, silver clad
- SPRING: Stainless steel
- HOOK LOCK: Stainless steel (latch)

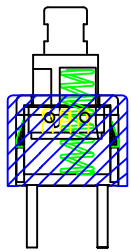

BTSA-N-P-0  
BTSA-L-P-0

FOOTPRINT : 5.8\*5.8MM  
HEIGHT : 10MM

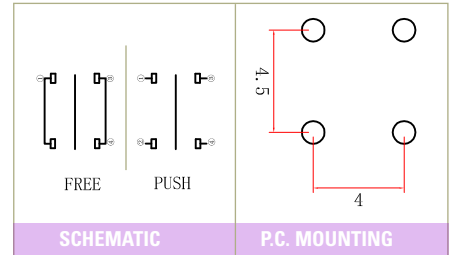
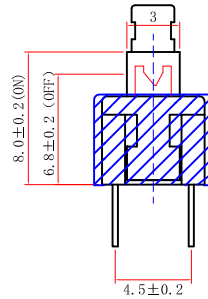
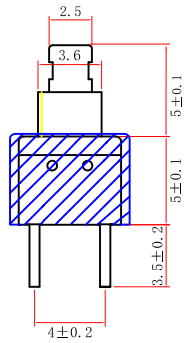
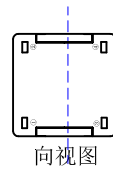
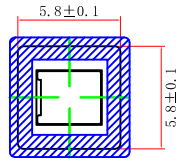

Detect

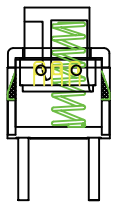

BTSA-N-P-1  
BTSA-L-P-1

FOOTPRINT : 5.8\*5.8MM  
HEIGHT : 8MM

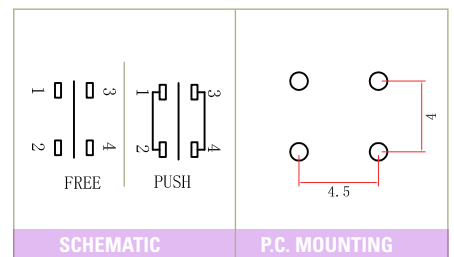
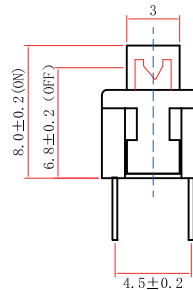
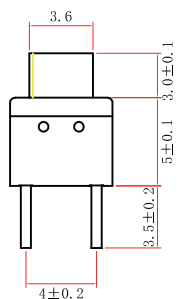
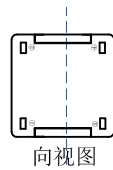
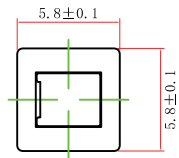

Dimensions are shown:mm  
Specifications and dimensions subject to change

# BTSA Series Push Switches

FOOTPRINT: 5.8\*5.8MM  
HEIGHT: 7.5MM

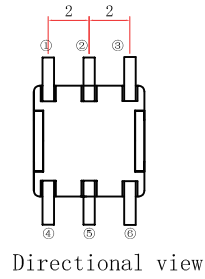
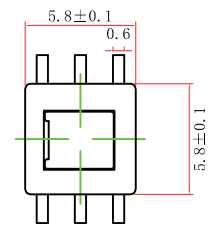
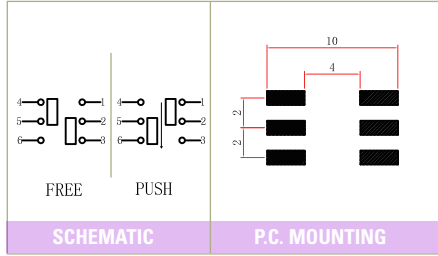

BTSA-N-S-2  
BTSA-L-S-2

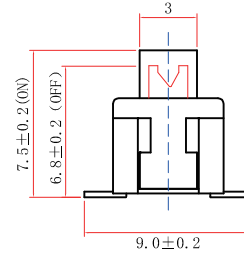
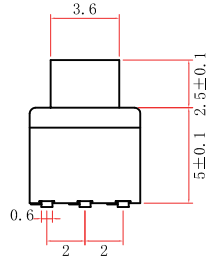

FOOTPRINT: 5.8\*5.8MM  
HEIGHT: 5.8MM

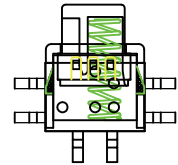
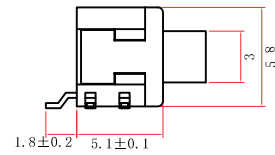
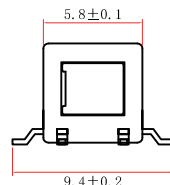
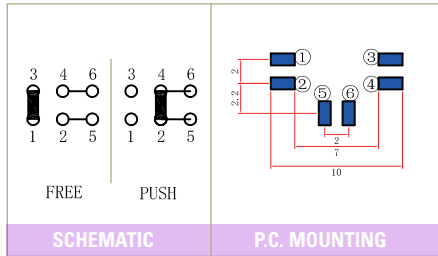

BTSA-N-S-3  
BTSA-L-S-3

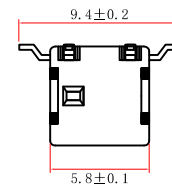
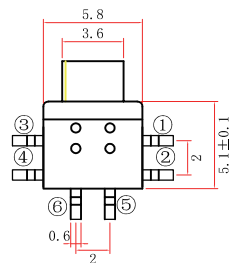

FOOTPRINT: 5.8\*5.8MM  
HEIGHT: 10.3MM

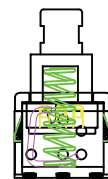
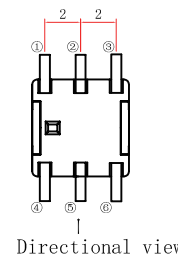
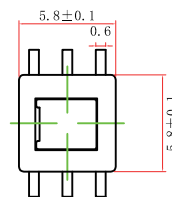
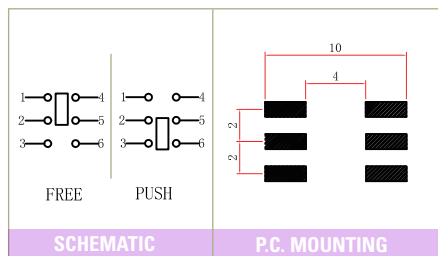

BTSA-N-S-4  
BTSA-L-S-4

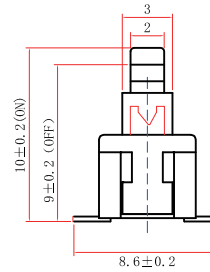
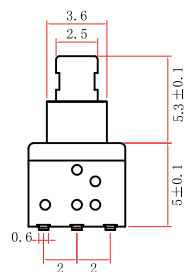

Detect



Third Angle Projection  
Dimensions are shown:mm  
Specifications and dimensions subject to change



# BTSA Series Push Switches

FOOTPRINT: 5.8\*5.8MM  
HEIGHT: 10MM



BTSA-N-S-5  
BTSA-L-S-5

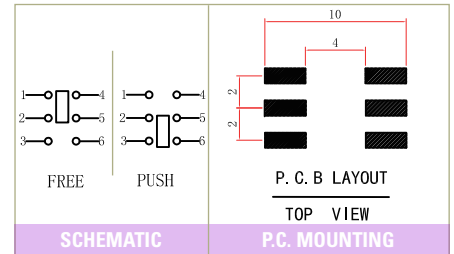
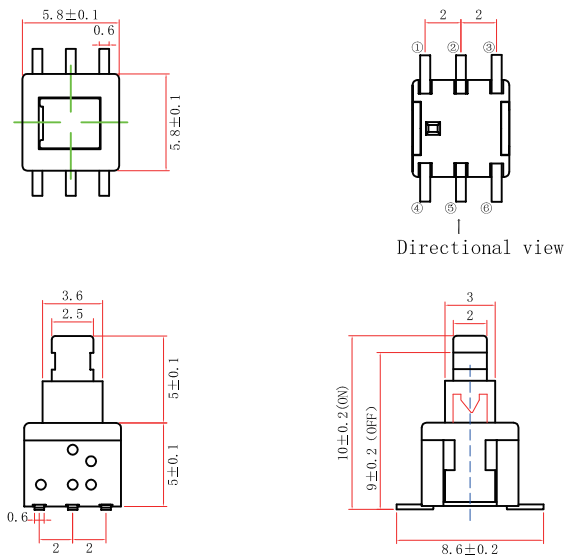

FOOTPRINT: 5.8\*10.1MM  
HEIGHT: 5.8MM

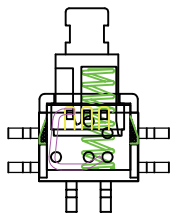

BTSA-N-S-6  
BTSA-L-S-6

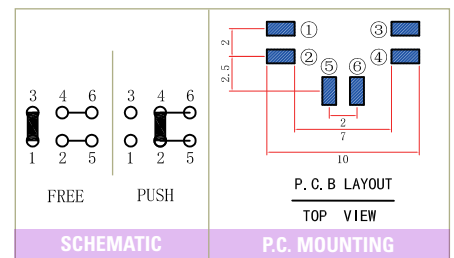
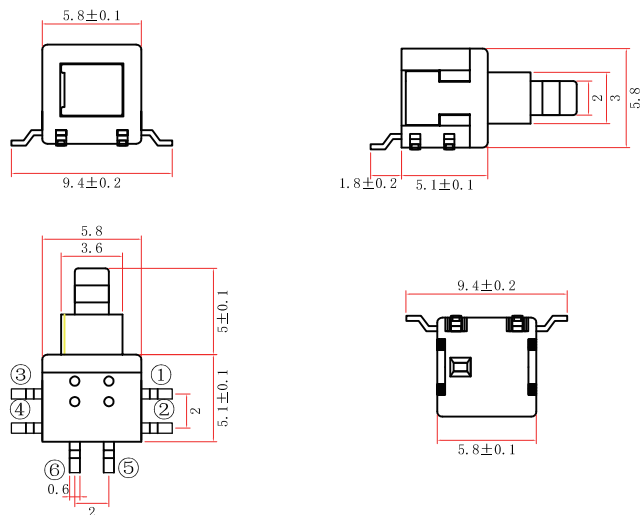

FOOTPRINT: 5.8\*10.1MM  
HEIGHT: 5.8MM

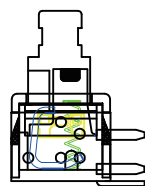

BTSA-N-P-7  
BTSA-L-P-7

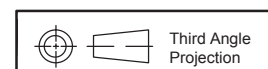
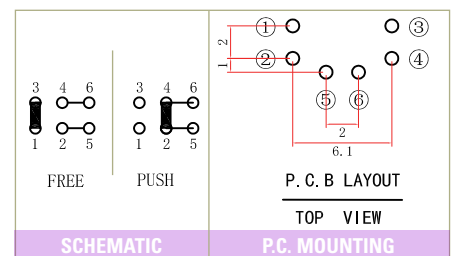
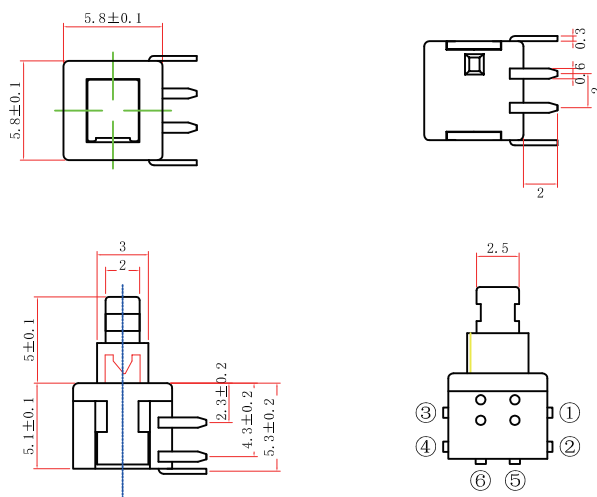

Dimensions are shown:mm  
Specifications and dimensions subject to change

www.ROCPU.tw

# BTSA Series Push Switches

FOOTPRINT: 5.8\*5.8MM  
HEIGHT: 7.5MM

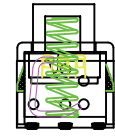
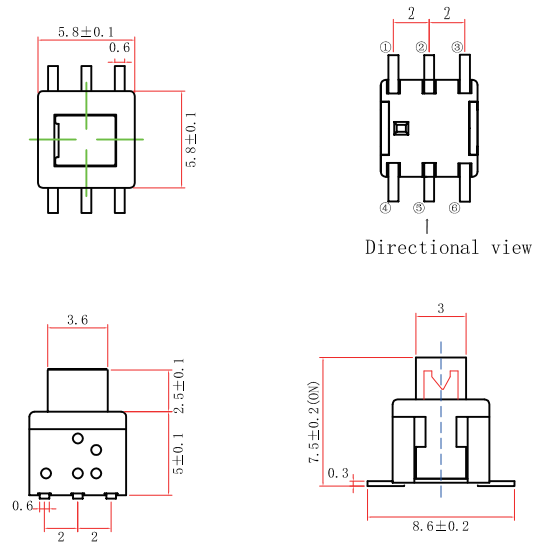
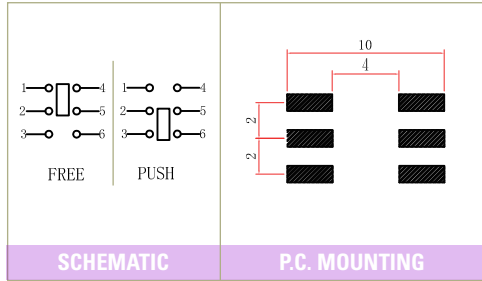

BTSA-N-S-8  
BTSA-L-S-8

FOOTPRINT: 5.8\*5.8MM  
HEIGHT: 10.1MM

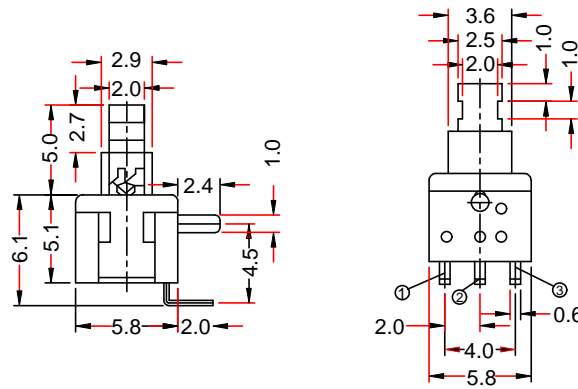
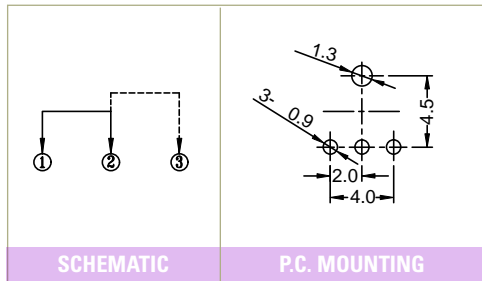

BTSA-N-P-9  
BTSA-L-P-9

FOOTPRINT: 7.0\*7.0MM  
HEIGHT: 12.2MM

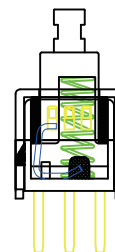
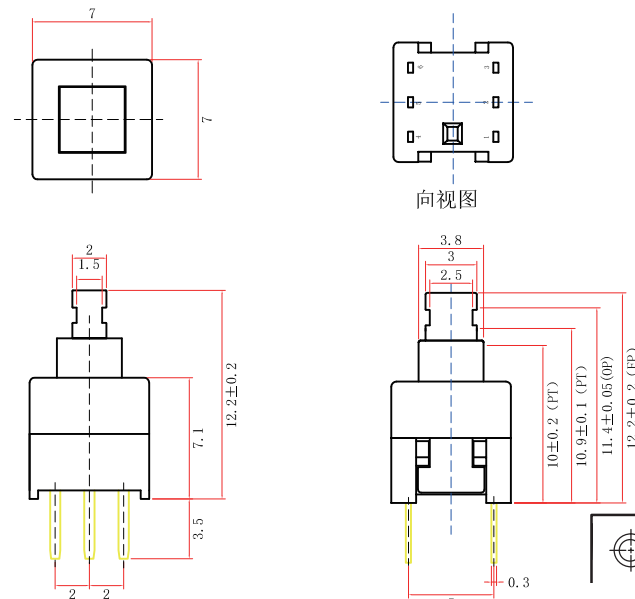
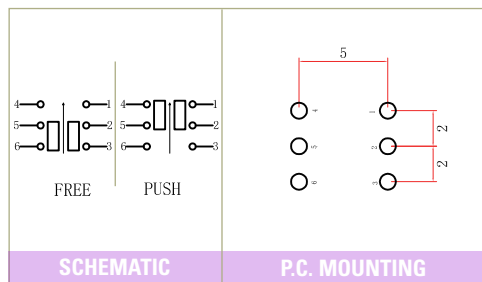

BTSA-N-P-10  
BTSA-L-P-10

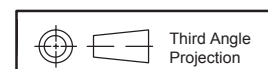

Dimensions are shown:mm  
Specifications and dimensions subject to change



Detect



# BTSA Series Push Switches

FOOTPRINT: 7.0\*7.0MM  
HEIGHT: 8.0MM

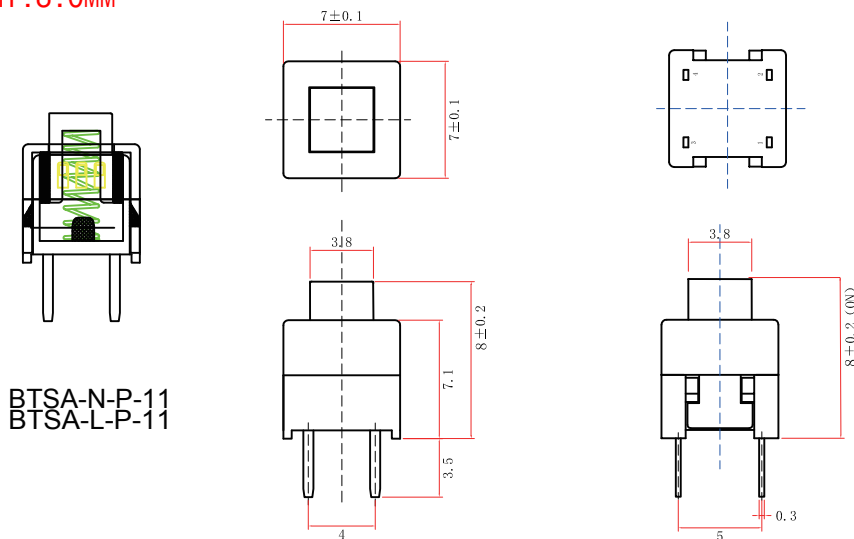

BTSA-N-P-11  
BTSA-L-P-11

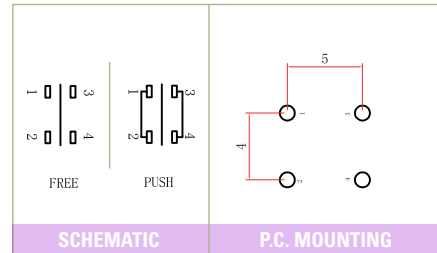

SCHEMATIC

P.C. MOUNTING

FOOTPRINT: 7.0\*7.0MM  
HEIGHT: 9.7MM

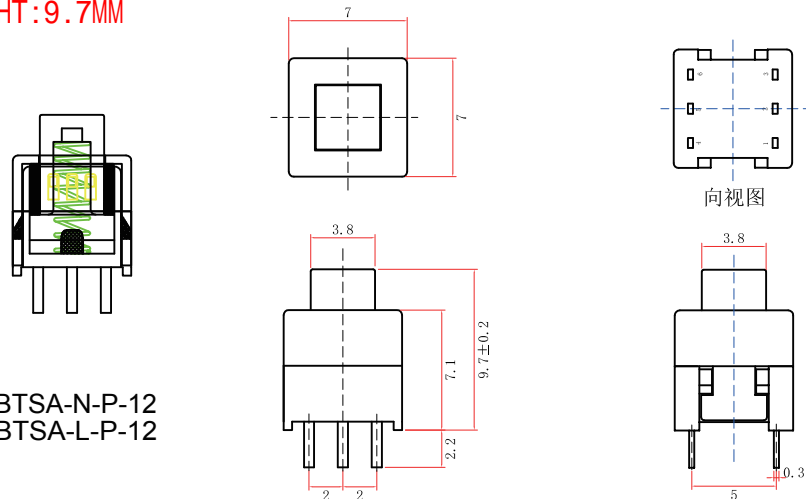

BTSA-N-P-12  
BTSA-L-P-12

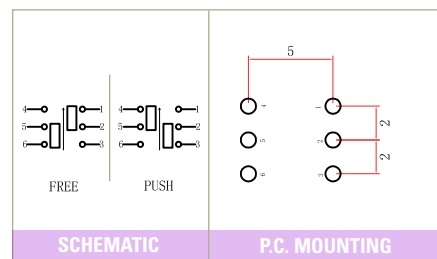

SCHEMATIC

P.C. MOUNTING

FOOTPRINT: 7.0\*7.0MM  
HEIGHT: 12.5MM

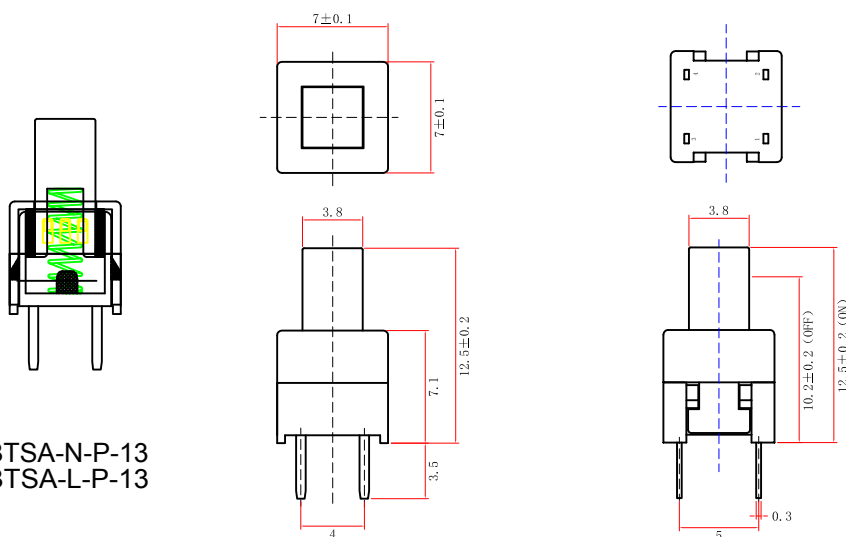

BTSA-N-P-13  
BTSA-L-P-13

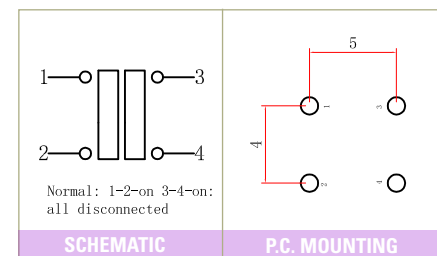

SCHEMATIC

P.C. MOUNTING



Detect

# BTSA Series Push Switches

FOOTPRINT: 7.0\*7.0MM  
HEIGHT: 9.7MM

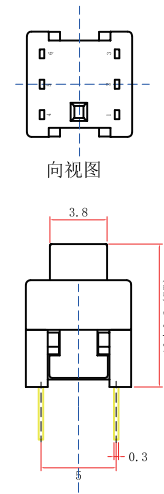
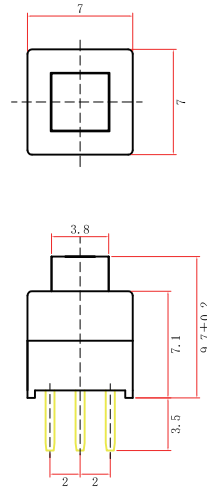
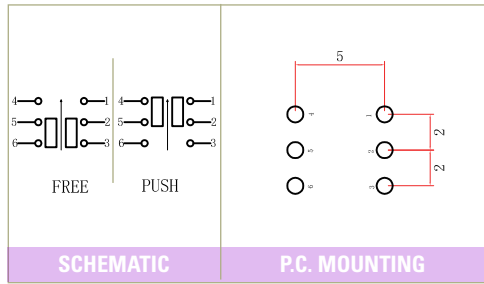

BTSA-N-P-14  
BTSA-L-P-14

FOOTPRINT: 8.0\*8.0MM  
HEIGHT: 13.4MM

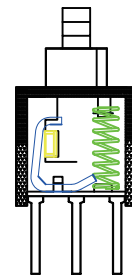
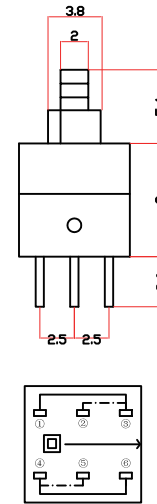
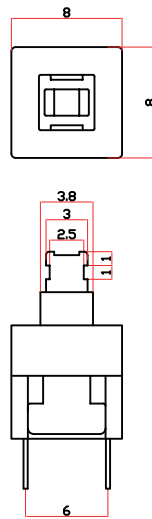
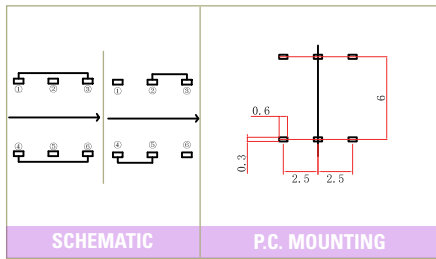

BTSA-N-P-15  
BTSA-L-P-15

FOOTPRINT: 8.0\*8.0MM  
HEIGHT: 13.4MM

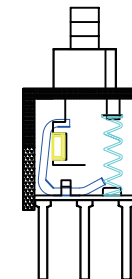
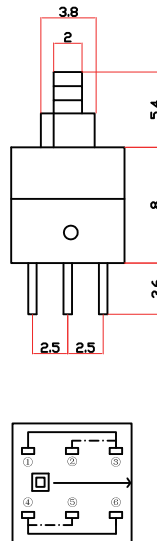
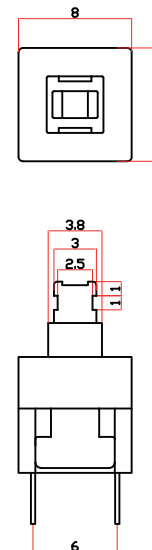
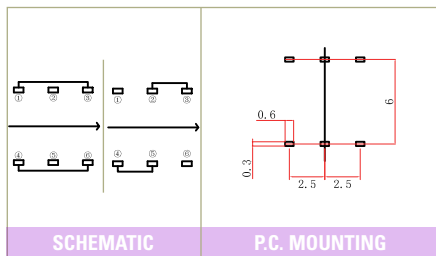

BTSA-N-P-16  
BTSA-L-P-16



Detect

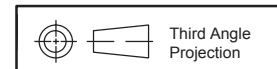

Dimensions are shown:mm  
Specifications and dimensions subject to change

# BTSA Series Push Switches

FOOTPRINT: 8.0\*8.0MM  
HEIGHT: 13.5MM

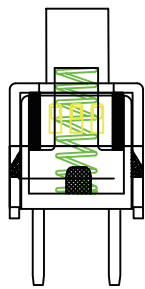

BTSA-N-P-17  
BTSA-L-P-17

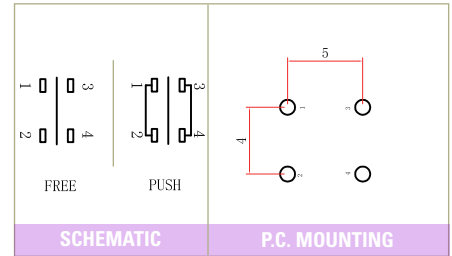
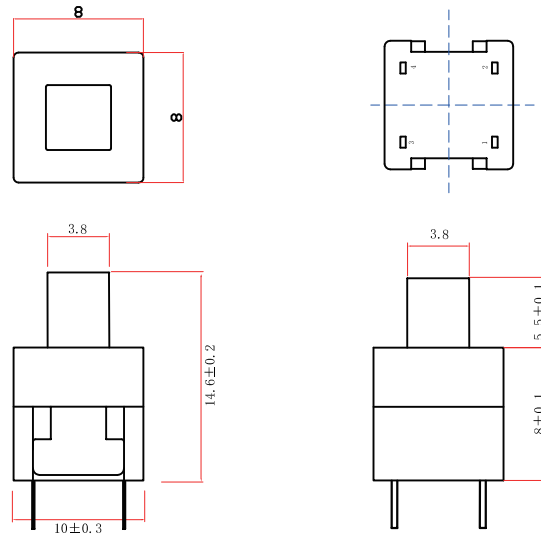

FOOTPRINT: 8.0\*8.0MM  
HEIGHT: 14.6MM

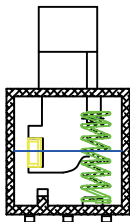

BTSA-N-S-18  
BTSA-L-S-18

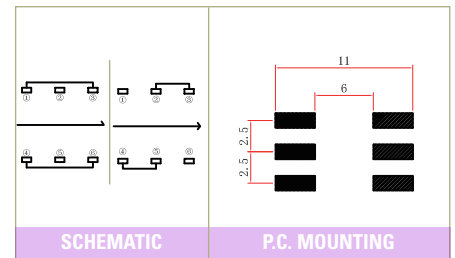
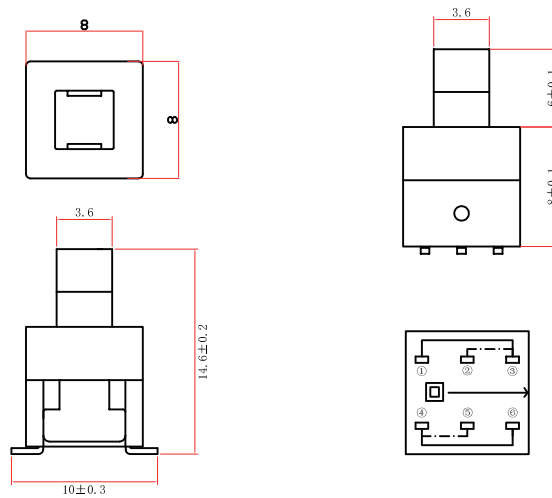

Detect

FOOTPRINT: 8.0\*8.0MM  
HEIGHT: 13.4MM

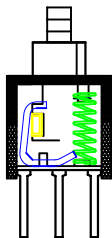

BTSA-N-P-19  
BTSA-L-P-19

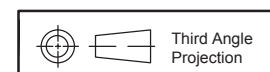
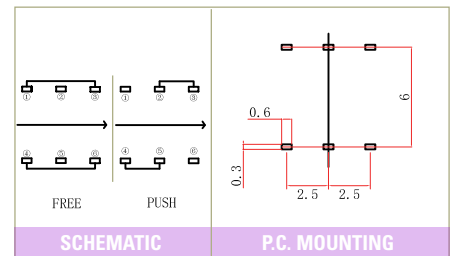
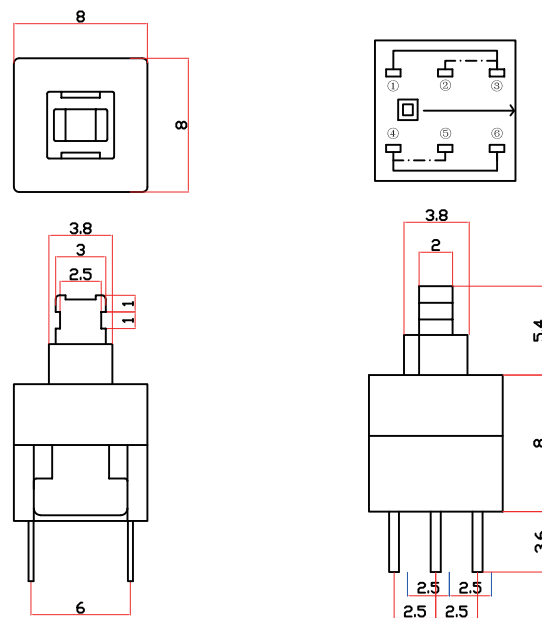

Third Angle  
Projection

Dimensions are shown:mm  
Specifications and dimensions subject to change

# BTSA Series Push Switches

FOOTPRINT: 8.45\*8.45MM  
HEIGHT: 15MM

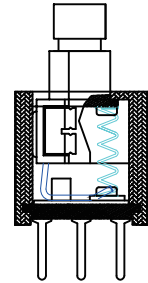
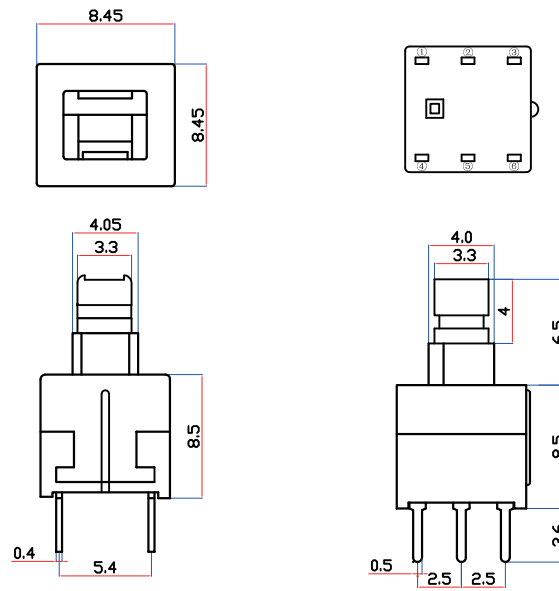
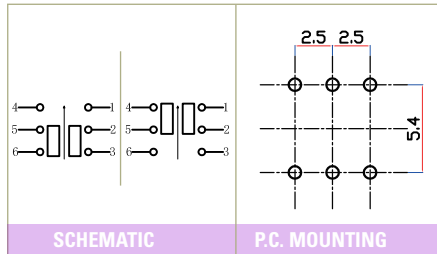

BTSA-N-P-20  
BTSA-L-P-20



Detect



## X-ON Electronics

Largest Supplier of Electrical and Electronic Components

*Click to view similar products for [Pushbutton Switches](#) category:*

*Click to view products by [ROCPU Technology](#) manufacturer:*

Other Similar products are found below :

[8971K1133](#) [LW2L-M1C20M-A](#) [M22-D-R-GB0/K11](#) [67021K512](#) [701PB580](#) [7199K101](#) [810K12910](#) [810KSV30B](#) [FLT 2U EE 01A](#)  
[MML21EA2ADK](#) [MML21KA3ABK](#) [MML23KA3AC05K-001](#) [MML23KW3AA01W](#) [8418K2](#) [8442K3](#) [8450K1](#) [860K11911T01A](#) [861901](#)  
[861K11911T01A07](#) [861K13810T00A14](#) [861K13911](#) [8646AB6X718UL](#) [9533CD4+U574+U4922](#) [99-450.837](#) [A2PMA1X03EC56](#) [A3A-7310](#)  
[A3A-7340](#) [12037A2ULCSA](#) [1203A2UL](#) [ABGW410-R](#) [ABN400-R](#) [121382](#) [1213C3](#) [HE3B-M2](#) [121194](#) [1212MRA](#) [1232A6NF](#)  
[1241.1183.7047](#) [121489](#) [1223A2ULCSA](#) [1241.1183.8000](#) [1241.1183.8029](#) [D5P-MT4](#) [13435AG](#) [13445AD29GX768](#) [AG23-L2](#) [AH165-](#)  
[2SGLG1TE3](#) [AH165-TGFY22](#) [AH165-TGL5Y11E3](#) [AH165-TGLR11AA3](#)