

BTSA Series Push Switches

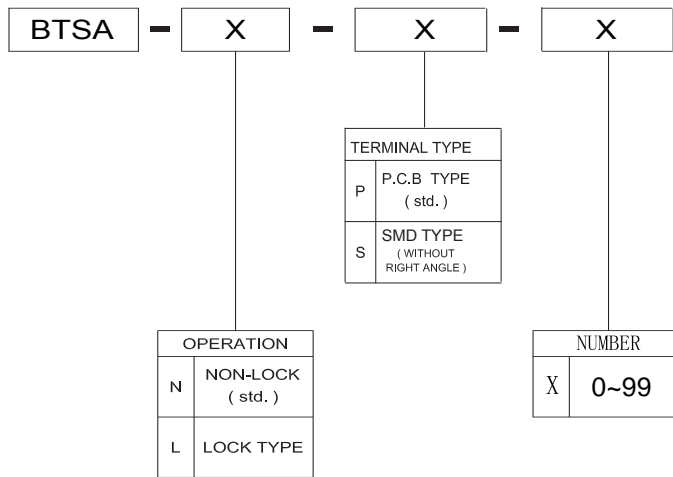

SPECIFICATIONS

| SWITCH SPECIFICATIONS | |
|---------------------------------|---|
| POLE - POSITION | SPDT , DPDT |
| CONTACT RATING | 12 V DC , 50 mA |
| CONTACT RESISTANCE | 100 mΩ MAX, 1.5 V DC; 100 mA, by Method of Voltage DROP |
| INSULATION RESISTANCE | 100 MΩ MIN, 500 V DC for 1 minute |
| DIELECTRIC STRENGTH | Breakdown Is not Allowable ; 500 V AC for 1 Minute |
| OPERATING FORCE | 250 ± 50 gf |
| OPERATING LIFE | 10,000 cycles |
| OPERATING TEMPERATURE RANGE | -20°C ~ 70°C |
| TOTAL TRAVEL / OPERATING TRAVEL | 2 ± 0.3 mm / 1.3 ± 0.3 mm |

Materials

- KNOB: POM Natural
- HOUSING: PA Black
- COVER: PC Grey
- TERMINAL: Bras, silver plated
- CONTACT CLIP: Phosphor bronze, silver clad
- SPRING: Stainless steel
- HOOK LOCK: Stainless steel (latch)

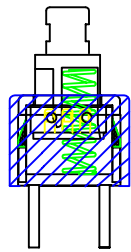

BTSA-N-P-0
BTSA-L-P-0

FOOTPRINT : 5.8*5.8MM
HEIGHT : 10MM

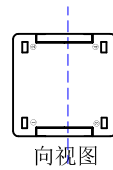
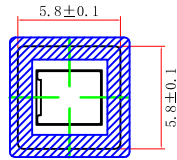

向视图

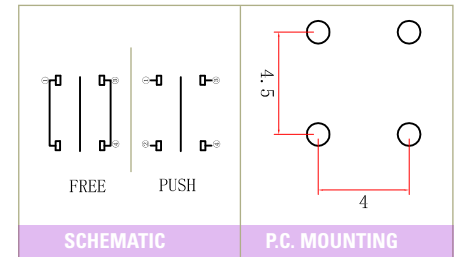
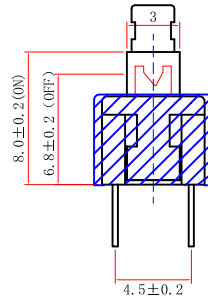
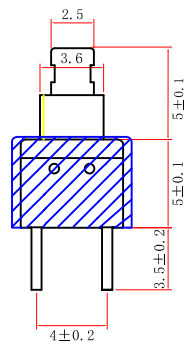

FOOTPRINT : 5.8*5.8MM
HEIGHT : 8MM



Detect

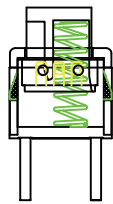

BTSA-N-P-1
BTSA-L-P-1

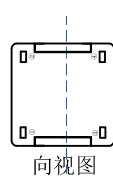
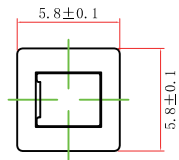

向视图

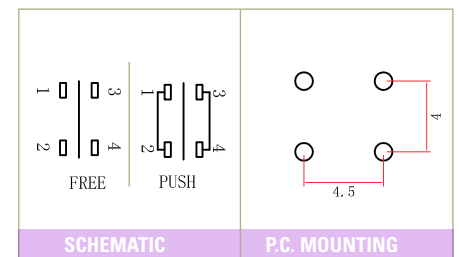
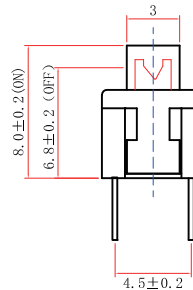
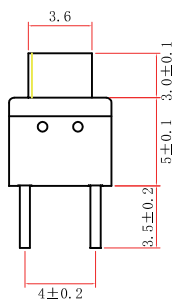

Third Angle Projection

Dimensions are shown:mm
Specifications and dimensions subject to change

BTSA Series Push Switches

FOOTPRINT: 5.8*5.8MM
HEIGHT: 7.5MM

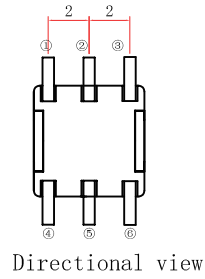
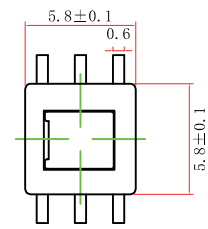
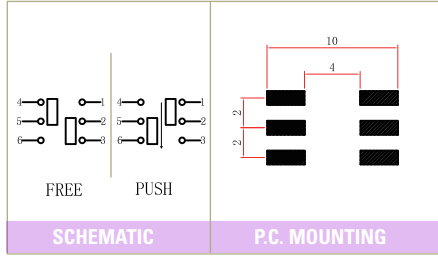

BTSA-N-S-2
BTSA-L-S-2

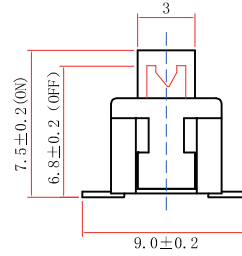
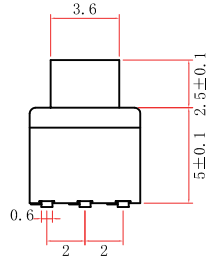

FOOTPRINT: 5.8*5.8MM
HEIGHT: 5.8MM

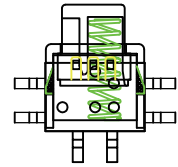
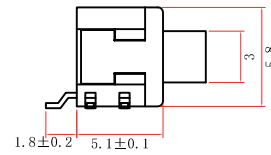
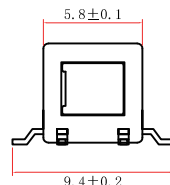
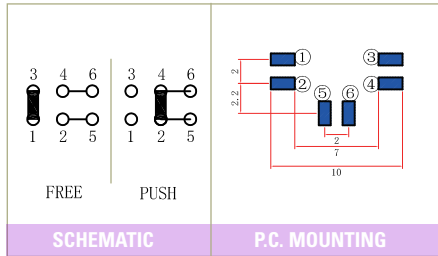

BTSA-N-S-3
BTSA-L-S-3

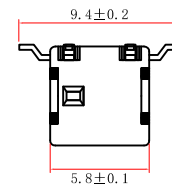
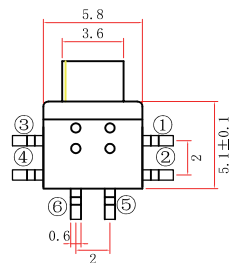

FOOTPRINT: 5.8*5.8MM
HEIGHT: 10.3MM

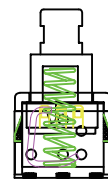
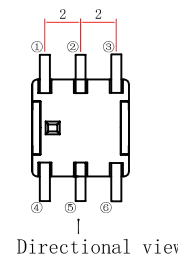
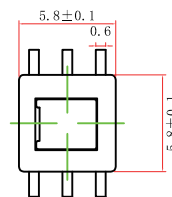
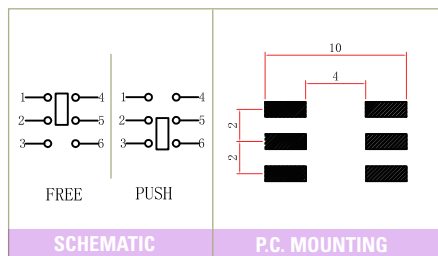

BTSA-N-S-4
BTSA-L-S-4

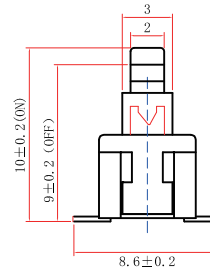
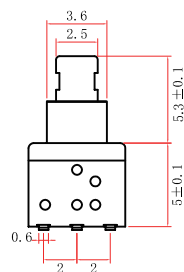

Detect



Third Angle Projection
Dimensions are shown:mm
Specifications and dimensions subject to change



BTSA Series Push Switches

FOOTPRINT: 5.8*5.8MM
HEIGHT: 10MM



BTSA-N-S-5
BTSA-L-S-5

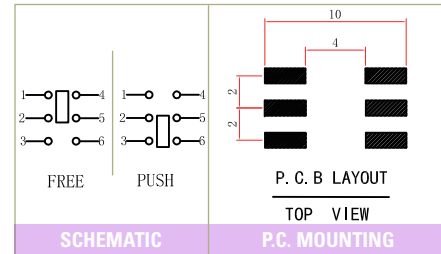
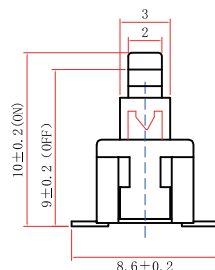
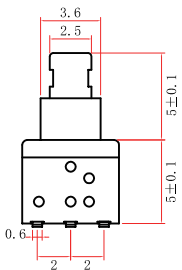
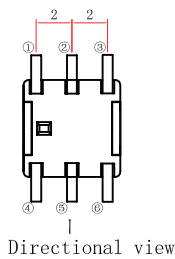
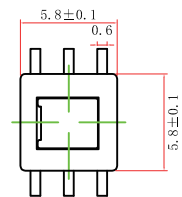

FOOTPRINT: 5.8*10.1MM
HEIGHT: 5.8MM

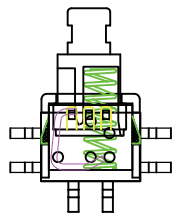

BTSA-N-S-6
BTSA-L-S-6

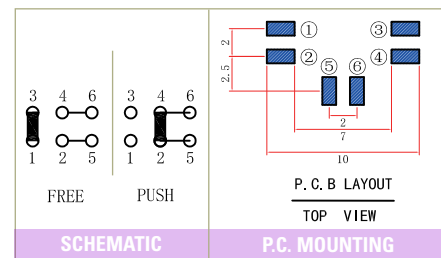
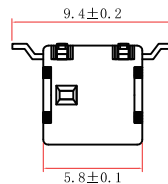
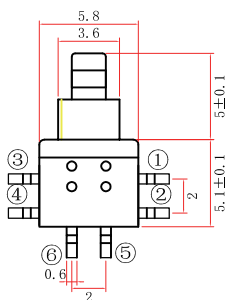
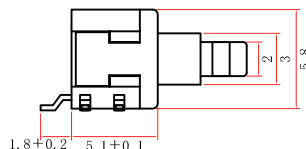
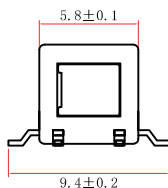

E

Detect

FOOTPRINT: 5.8*10.1MM
HEIGHT: 5.8MM

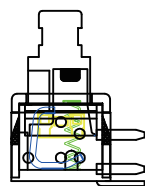

BTSA-N-P-7
BTSA-L-P-7

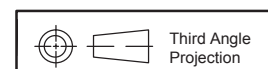
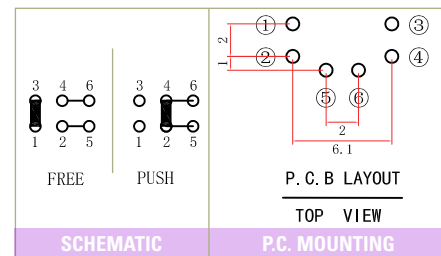
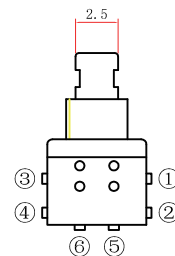
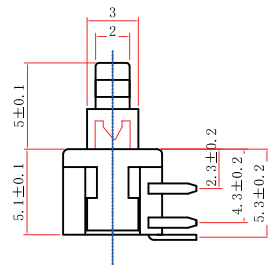
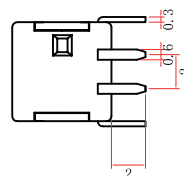
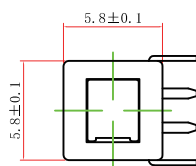

Dimensions are shown:mm
Specifications and dimensions subject to change

BTSA Series Push Switches

FOOTPRINT: 5.8*5.8MM
HEIGHT: 7.5MM

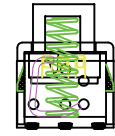
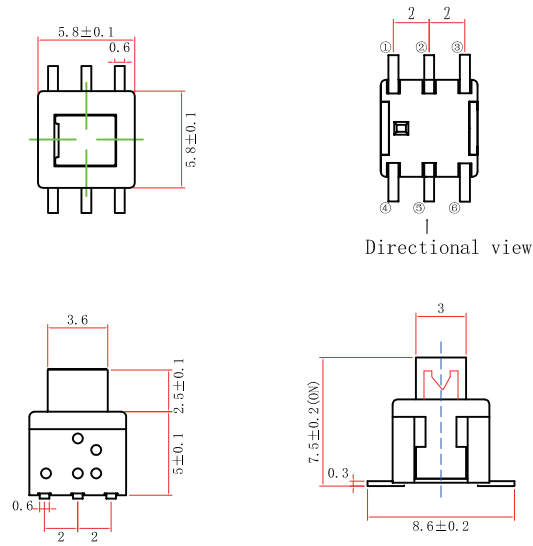
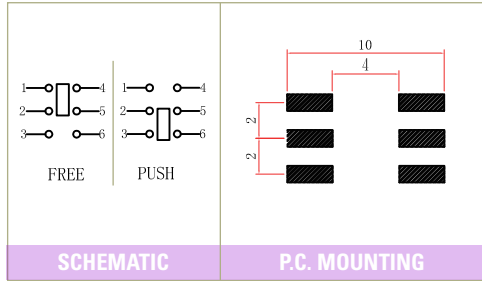

BTSA-N-S-8
BTSA-L-S-8

FOOTPRINT: 5.8*5.8MM
HEIGHT: 10.1MM

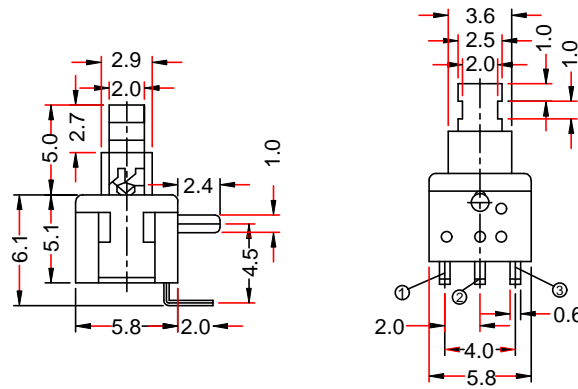
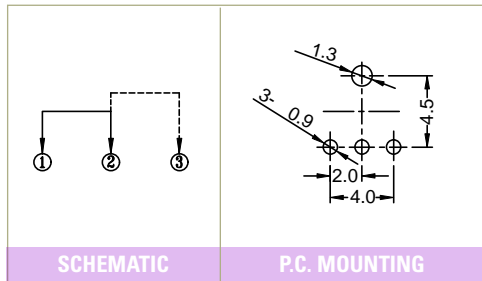

BTSA-N-P-9
BTSA-L-P-9

FOOTPRINT: 7.0*7.0MM
HEIGHT: 12.2MM

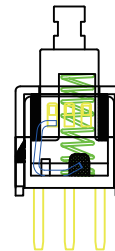
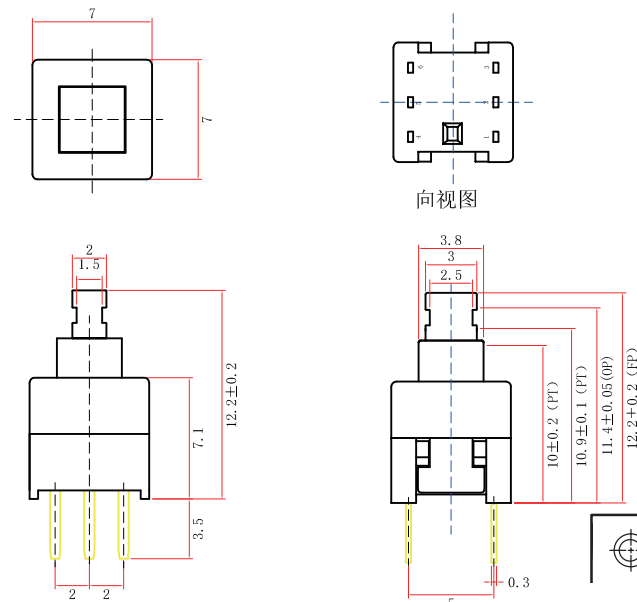
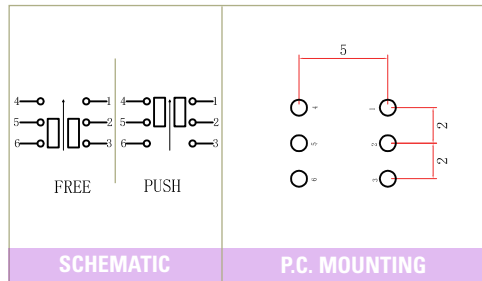

BTSA-N-P-10
BTSA-L-P-10

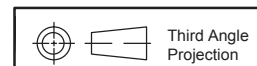

Third Angle Projection
Dimensions are shown:mm
Specifications and dimensions subject to change



Detect

BTSA Series Push Switches

FOOTPRINT: 7.0*7.0MM
HEIGHT: 8.0MM

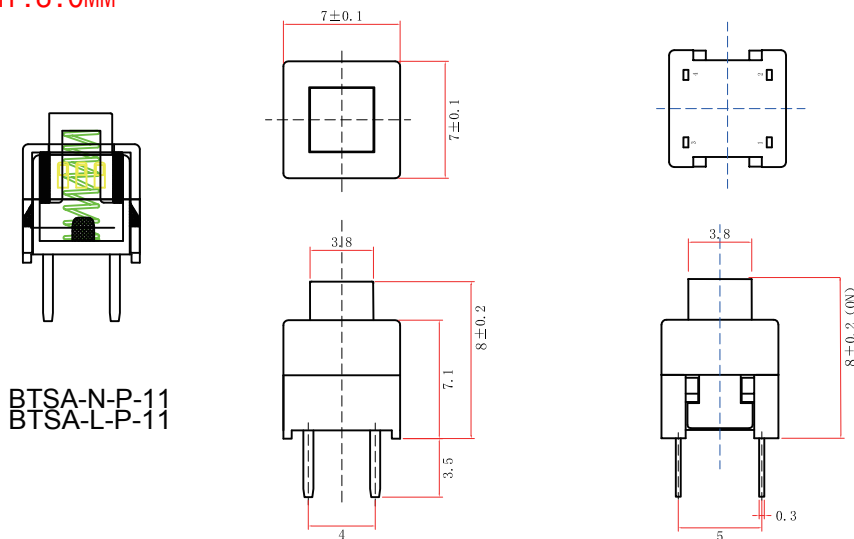

BTSA-N-P-11
BTSA-L-P-11

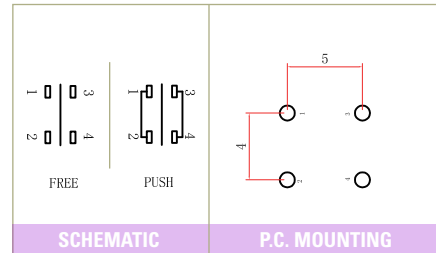

SCHEMATIC

P.C. MOUNTING

FOOTPRINT: 7.0*7.0MM
HEIGHT: 9.7MM

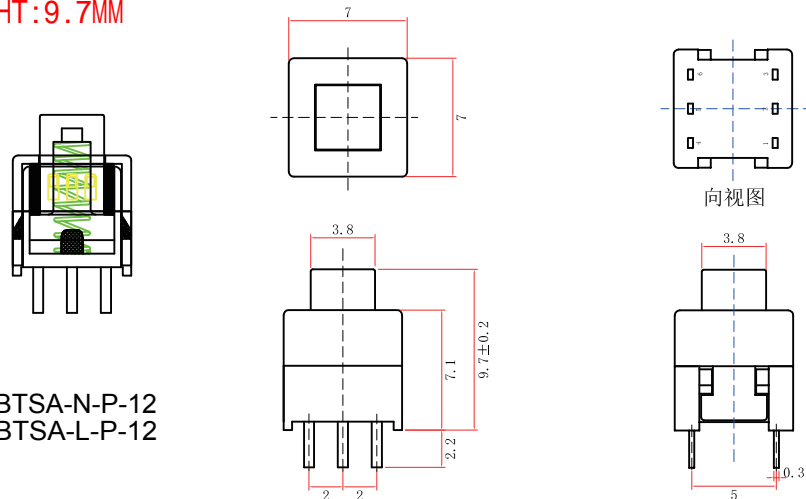

BTSA-N-P-12
BTSA-L-P-12

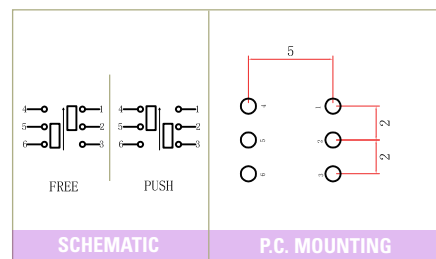

SCHEMATIC

P.C. MOUNTING

FOOTPRINT: 7.0*7.0MM
HEIGHT: 12.5MM

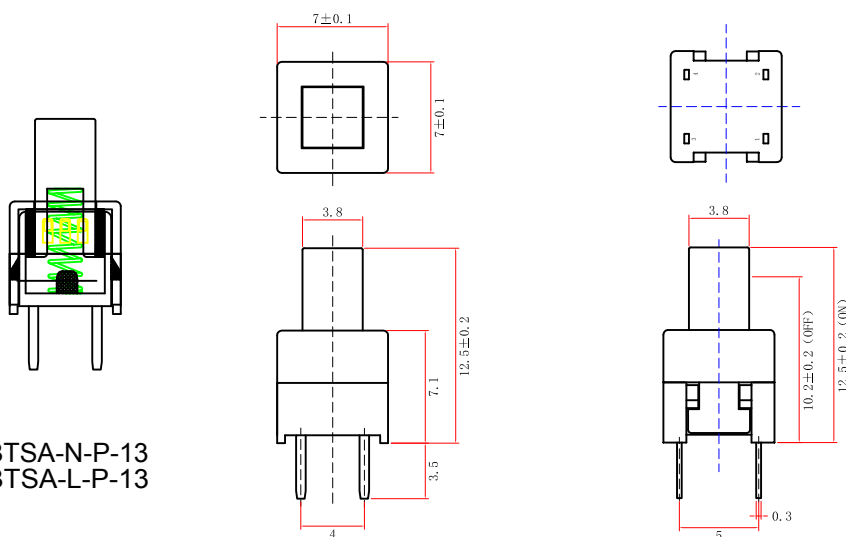

BTSA-N-P-13
BTSA-L-P-13

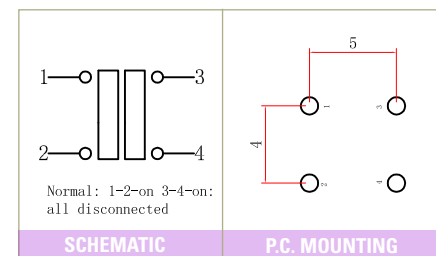

SCHEMATIC

P.C. MOUNTING



Detect

BTSA Series Push Switches

FOOTPRINT: 7.0*7.0MM
HEIGHT: 9.7MM

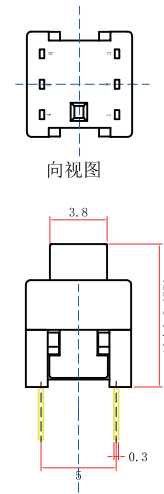
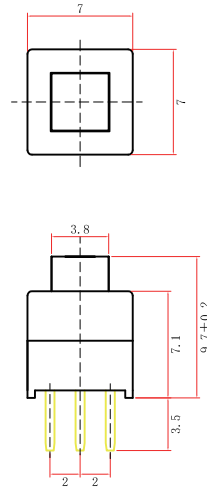
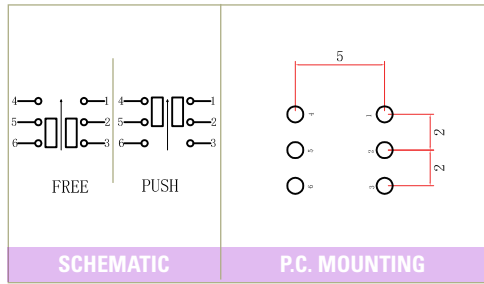

BTSA-N-P-14
BTSA-L-P-14

FOOTPRINT: 8.0*8.0MM
HEIGHT: 13.4MM

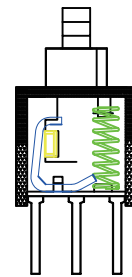
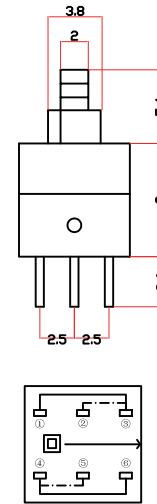
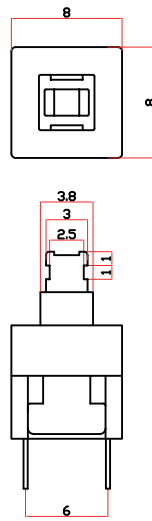
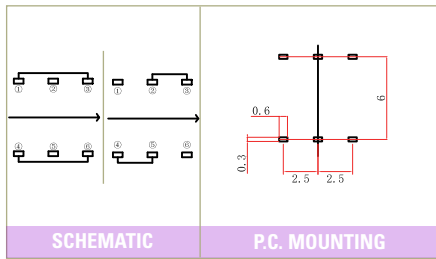

BTSA-N-P-15
BTSA-L-P-15

FOOTPRINT: 8.0*8.0MM
HEIGHT: 13.4MM

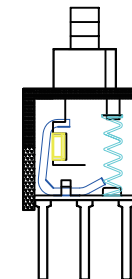
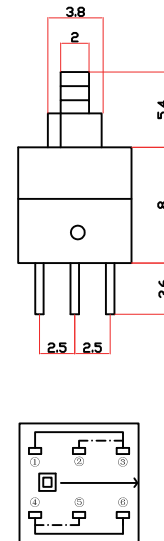
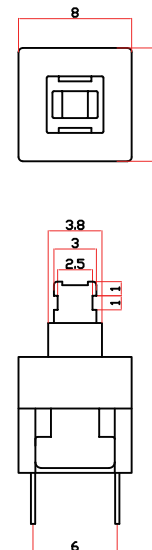
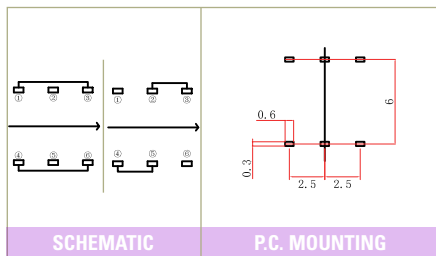

BTSA-N-P-16
BTSA-L-P-16



Detect

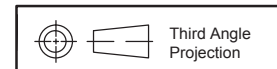

Dimensions are shown:mm
Specifications and dimensions subject to change

BTSA Series Push Switches

FOOTPRINT: 8.0*8.0MM
HEIGHT: 13.5MM

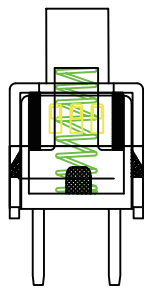

BTSA-N-P-17
BTSA-L-P-17

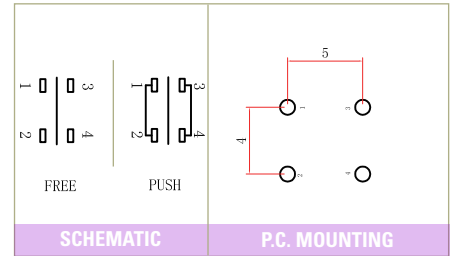
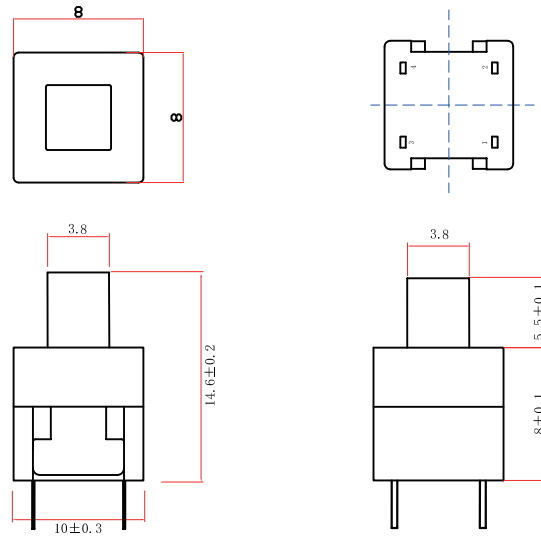

FOOTPRINT: 8.0*8.0MM
HEIGHT: 14.6MM

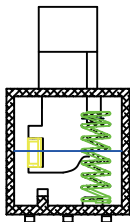

BTSA-N-S-18
BTSA-L-S-18

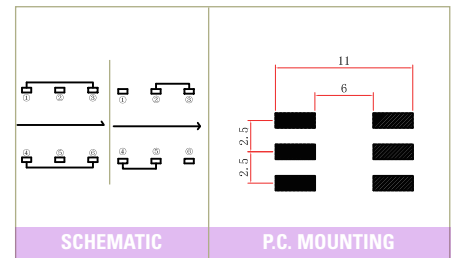
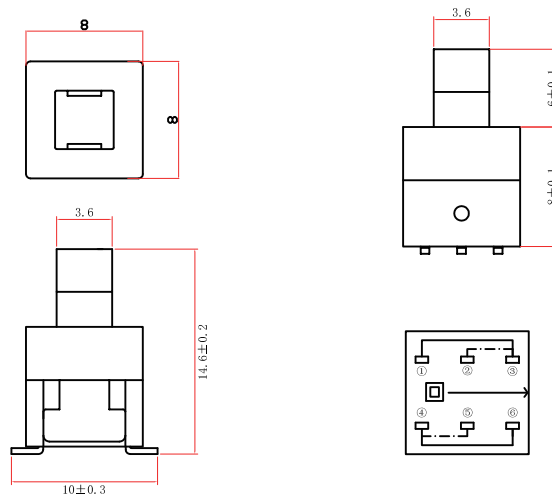

Detect

FOOTPRINT: 8.0*8.0MM
HEIGHT: 13.4MM

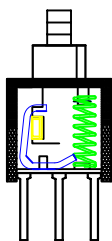

BTSA-N-P-19
BTSA-L-P-19

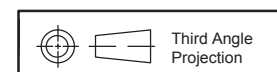
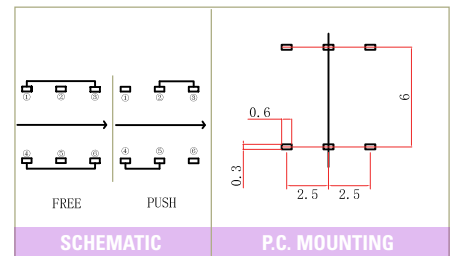
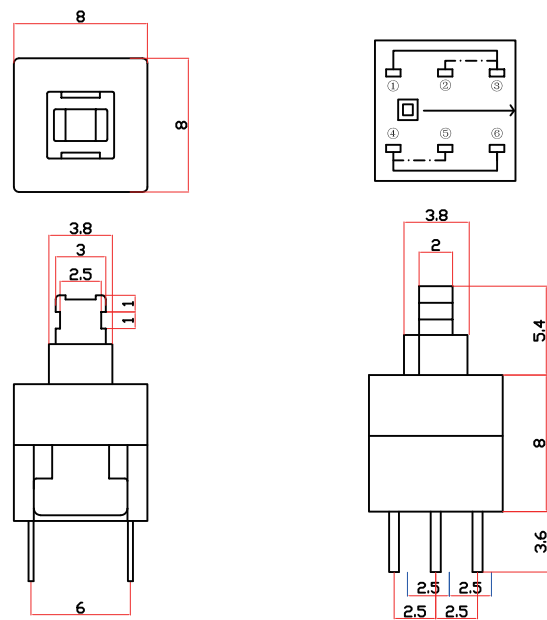

Third Angle
Projection

Dimensions are shown:mm
Specifications and dimensions subject to change

BTSA Series Push Switches

FOOTPRINT: 8.45*8.45MM
HEIGHT: 15MM

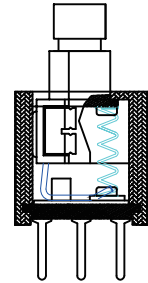
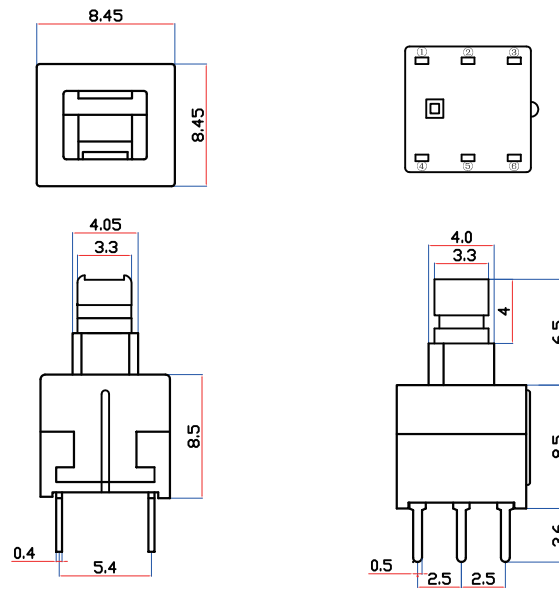
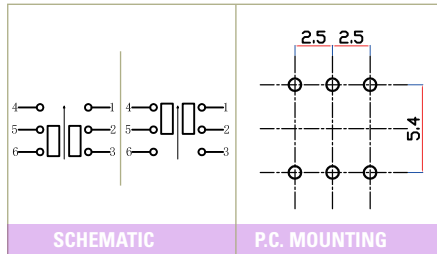

BTSA-N-P-20
BTSA-L-P-20



Detect

X-ON Electronics

Largest Supplier of Electrical and Electronic Components

Click to view similar products for [Pushbutton Switches](#) category:

Click to view products by [ROCPU Technology](#) manufacturer:

Other Similar products are found below :

[8971K1133](#) [LW2L-M1C20M-A](#) [M22-D-R-GB0/K11](#) [67021K512](#) [701PB580](#) [7199K101](#) [810K12910](#) [810KSV30B](#) [FLT 2U EE 01A](#)
[MML21EA2ADK](#) [MML21KA3ABK](#) [MML23KA3AC05K-001](#) [MML23KW3AA01W](#) [8418K2](#) [8442K3](#) [8450K1](#) [860K11911T01A](#) [861901](#)
[861K11911T01A07](#) [861K13810T00A14](#) [861K13911](#) [8646AB6X718UL](#) [9533CD4+U574+U4922](#) [99-450.837](#) [99-453.837](#)
[A2PMA1X03EC56](#) [A3A-7310](#) [A3A-7340](#) [12037A2ULCSA](#) [1203A2UL](#) [ABGW410-R](#) [1211390004](#) [ABN400-R](#) [121382](#) [1213C3](#) [HE3B-M2](#)
[1211500044](#) [121194](#) [1212MRA](#) [1232A6NF](#) [1241.1183.7047](#) [121489](#) [1223A2ULCSA](#) [1241.1183.8000](#) [1241.1183.8029](#) [D5P-MT4](#)
[13435AG](#) [13445AD29GX768](#) [AG23-L2](#) [AH165-2SGLG1TE3](#)