

1

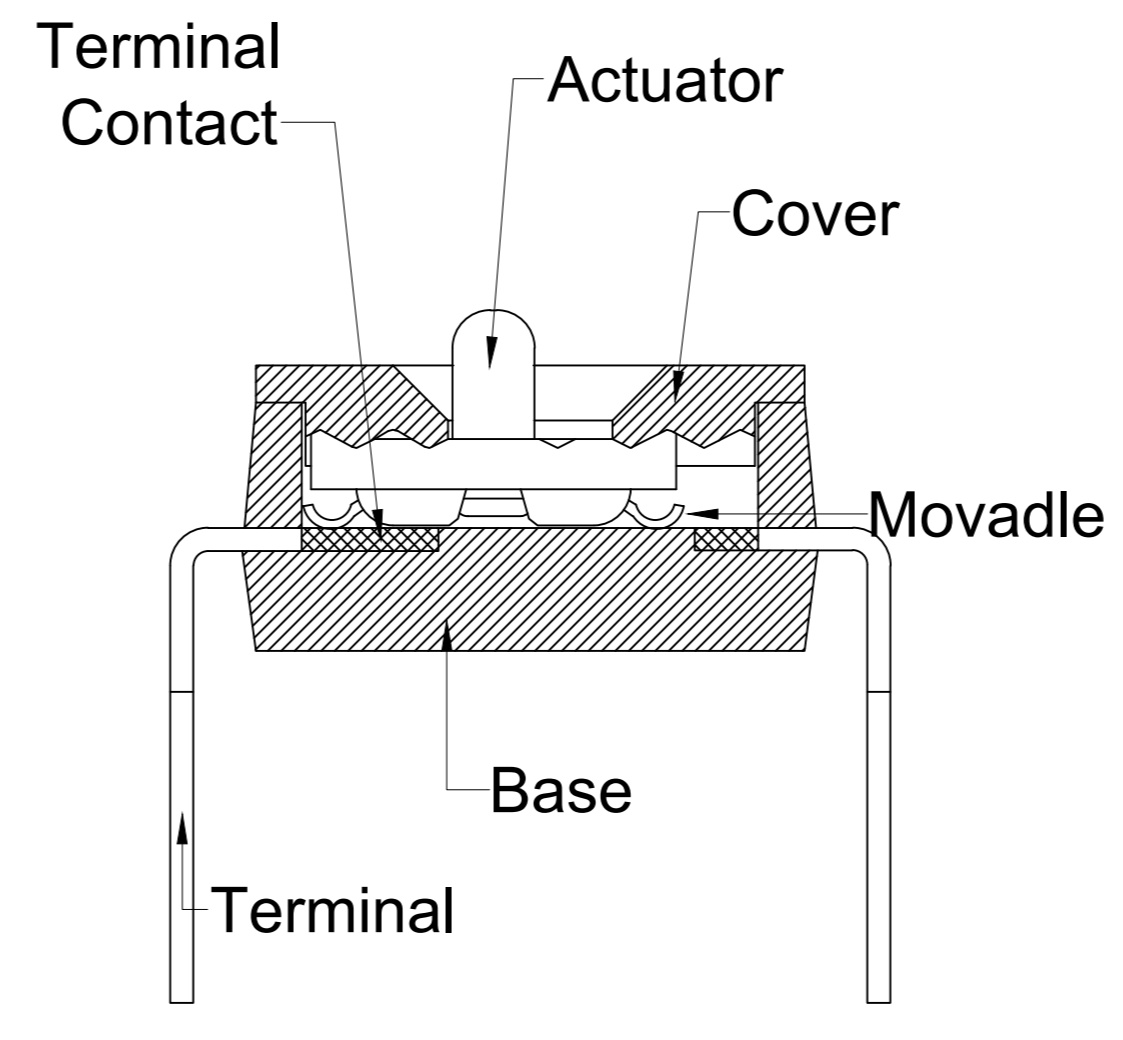

Switching:25mA at 24VDC
 Non-Switching:100mA at 50VDC
 Initial:50m Ω Max
 After life:100mΩ Max
 Insulation Resistance:100mΩ Min,60 sec at 500VDC
 Dielectric Strength:500VAC for 60seconds
 Swith Capacitance:5pF Max at 1MHZ
 Operation Temperature:-30°C to + 85°C
 Storage Temperature:-40°C to + 85°C
 Operation Force:500gf Max
 Mechanical Life:3000 cycles operations
 Resistance to Soldering:260±5°C for 3-5 seconds

2

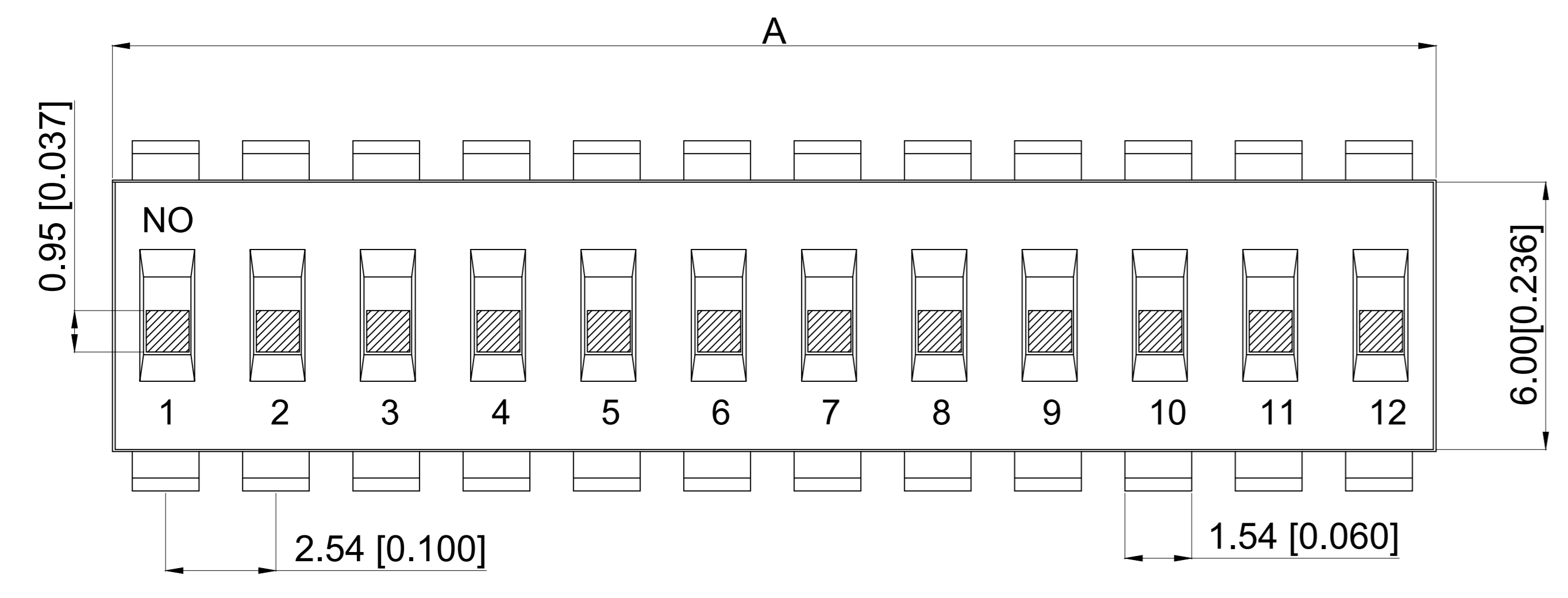
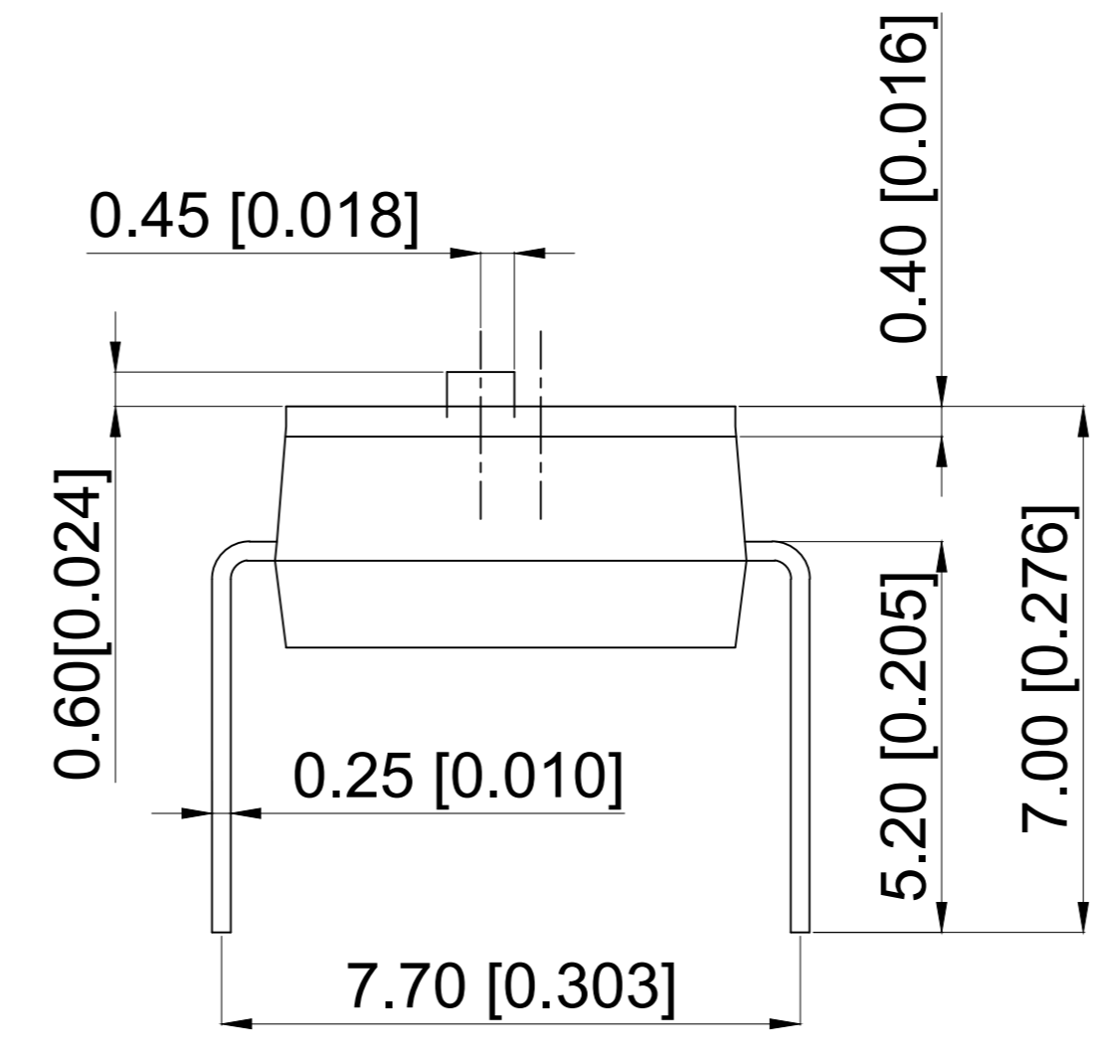
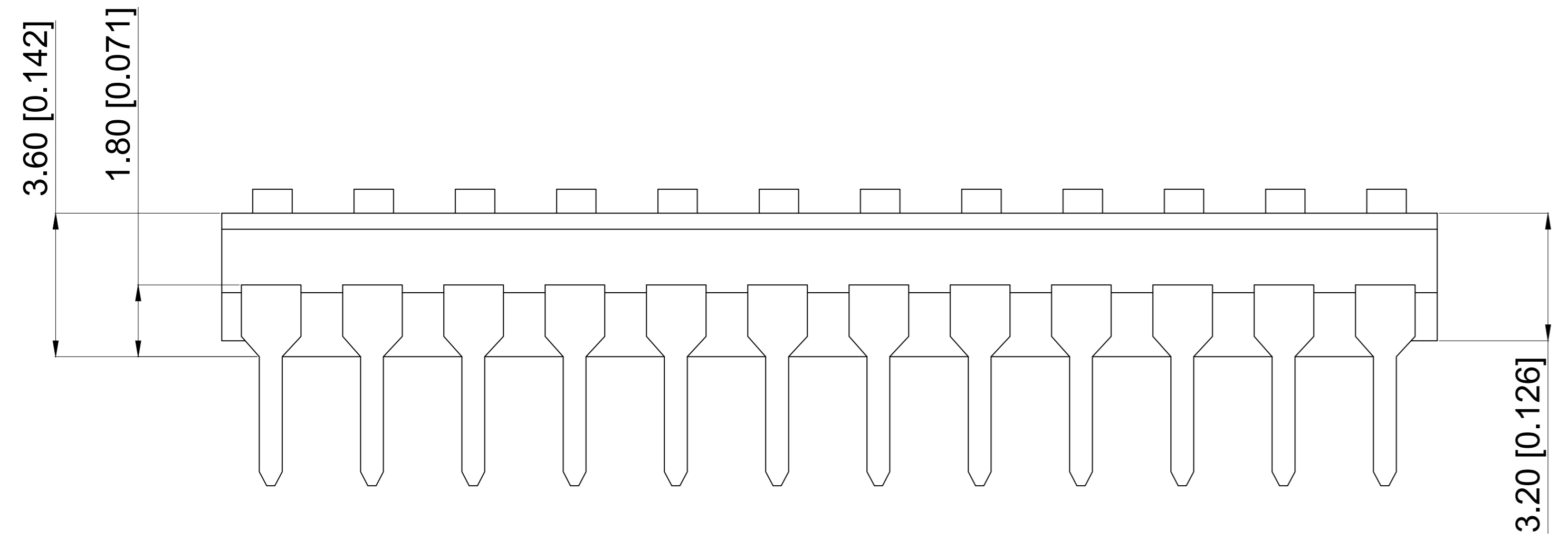

Poles(N)	A Dimension(mm)
01	2.54
02	5.08
03	7.62
04	10.16
05	12.70
06	15.24
07	17.78
08	20.32
09	22.86
10	25.40
12	30.48

3

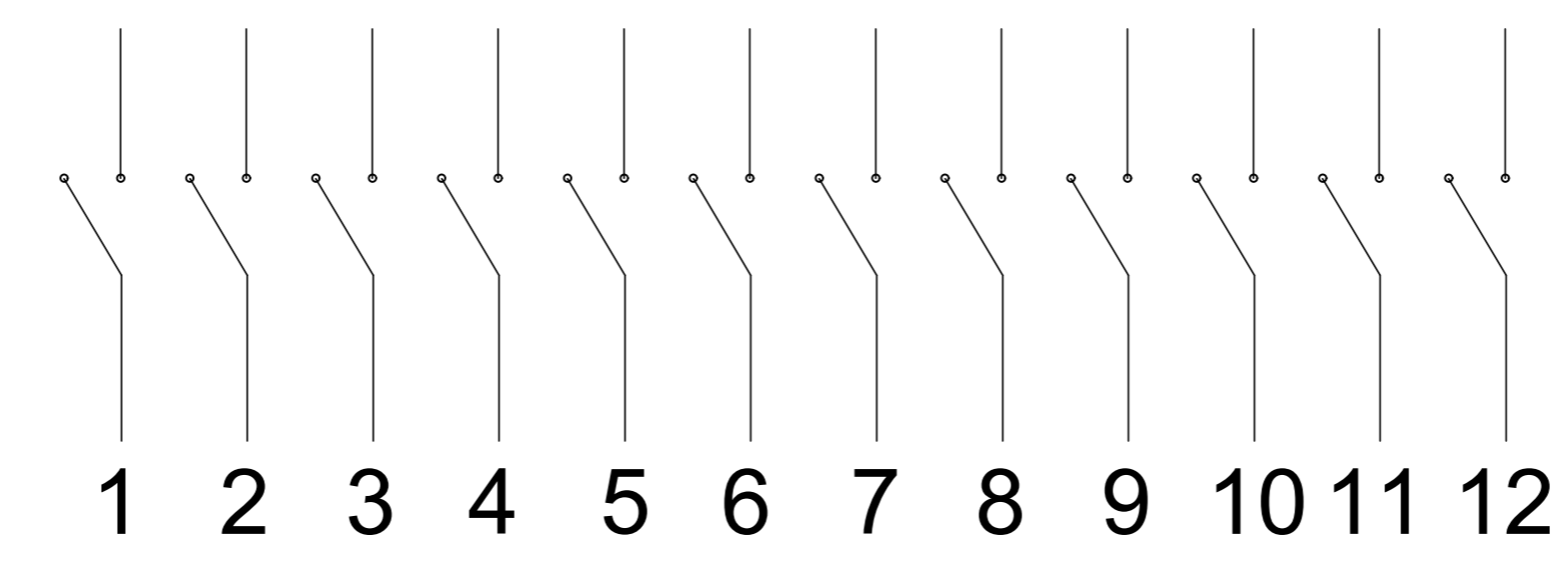
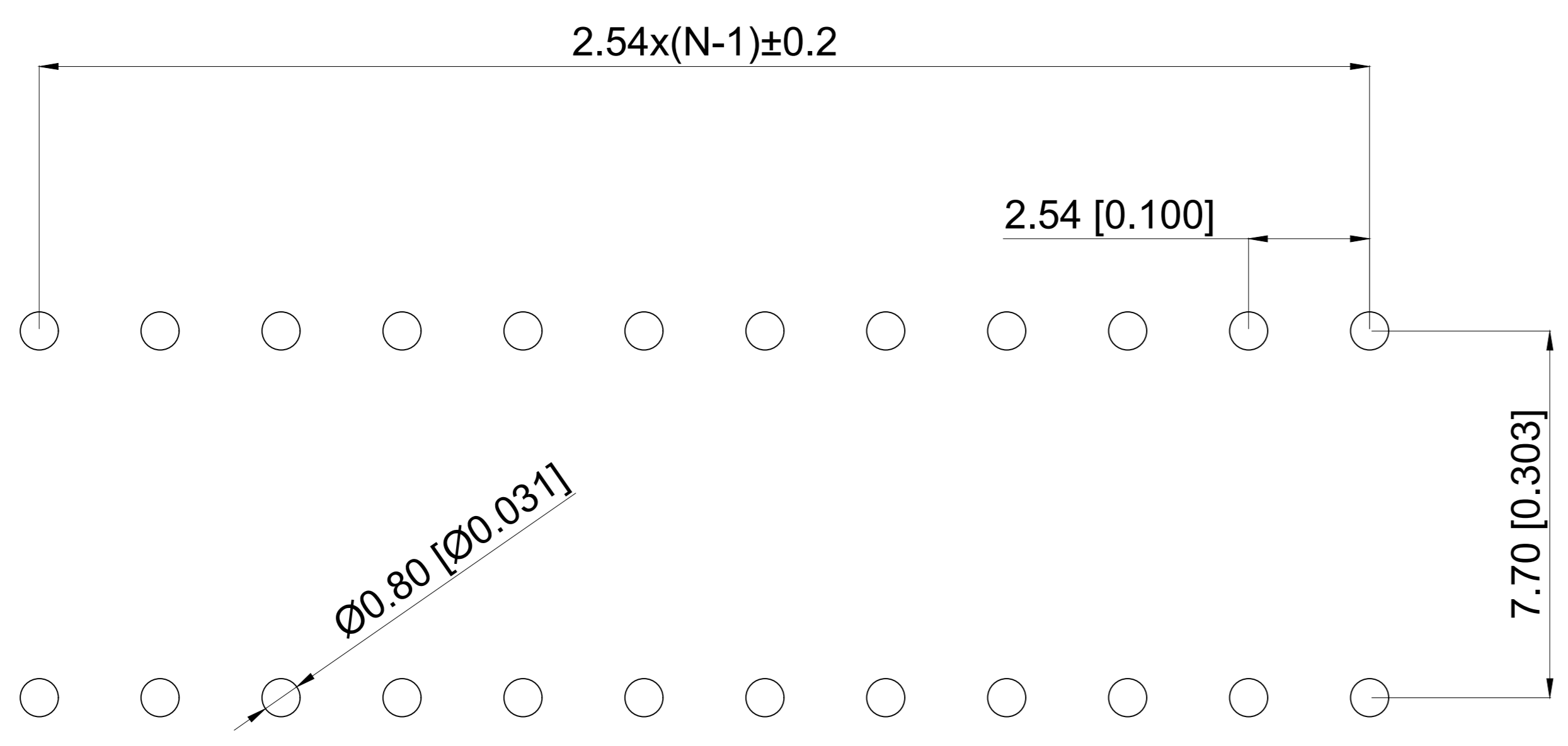

SCHMATIC

Part Name	Material	Finished
Base	PPS UL94 VO	Black
Cover	PPS UL94 VO	Black
Actuator	Nylon UL94 VO	White
Movadle	Copper Alloy	Gold
Terminal Contact	Brass	Gold
Terminal	Brass	Gold/Tin

4

REV	DATE	REVISION	DESCRIPTION	ISSUE
A4				
A3			Terminal	
A2				
A1				

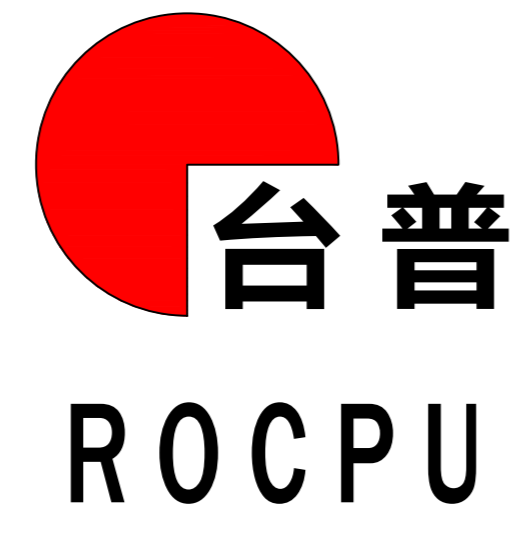

COMMON	TOLERANCE
X.XX	± 0.10
X.X	± 0.15
X	± 0.25
ANGULAR	—

UNIT	MM	PROJECTED	PRODUCT NAME:
DRAWN BY	FUYUAN	CHECKED BY	COCO
DATE	2019	APPROVAL B	ALEN
<h1>ROCPCU TECHNOLOGY CO.,LTD</h1>		MODEL NO: TAM105EZ Https: www.rocpcu.tw	
		Copies are issued in strict confidence and shall not be reproduced or copied, or used as the basic of manufacture or sale of apparatus without permission	

5

5

X-ON Electronics

Largest Supplier of Electrical and Electronic Components

Click to view similar products for [DIP Switches/SIP Switches](#) category:

Click to view products by [ROCPU Technology](#) manufacturer:

Other Similar products are found below :

[79B10T](#) [8136-475G4T](#) [G7G-1A2-CB-DC12](#) [DRS4016](#) [1825444-1](#) [193005MS](#) [195010MS](#) [200183](#) [206002](#) [208004](#) [208007ST](#) [208008](#)
[25.350.0653.0](#) [SDA10H1BDA](#) [97R06ST](#) [A2C-2A5](#) [1825444-7](#) [ADE12S04](#) [206005RAS](#) [206007](#) [209005LPST](#) [2-1825058-8](#) [219002LPST](#)
[219002MSTJRF](#) [219012MST](#) [25.352.0353.0](#) [CXDRIVEV2X](#) [LA2-002-DC24](#) [DSR02T](#) [193004MS](#) [E2FMX2D1M1TGJ03M](#) [NDI10H](#) [219-](#)
[9MSTP](#) [219008LPSTR](#) [EPM02FV](#) [206010RAST](#) [76SB05](#) [TD06H0SK1](#) [Z7.255.9027.0](#) [1-1825058-3](#) [1825428-4](#) [219-10LPSTF](#)
[E3ZG6111D03M](#) [G4D212PUSTV2DC5](#) [HARW0002](#) [EPG301BT06](#) [1-1825058-6](#) [E3TSL23M5J03M](#) [Y5795](#) [7R0060](#)