

# THS SERIES HALF PITCH SMT TYPE, THE LOWEST PROFILE DIP SWITCH

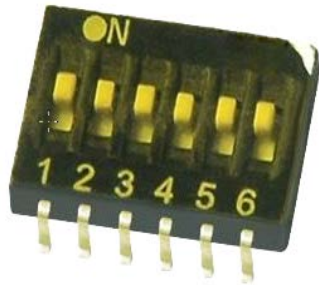

THS 1.27mm PITCH



THS J-Hook Type

## FEATURES

- Standard 0.05" integrated circuit pitch.
- Smaller size makes better heat convection during PC board wave soldering.
- Top tape sealed to withstand wave soldering, board washing.
- All plastics are UL 94V-0 grade fire retardant.
- Gold plated contact to ensure low contact resistance and long mechanical life.
- RoHS Compliant

## APPLICATIONS

- Hand-held electronic devices, such as PDA, MP3, radios
- Portable computer and electronic devices, such as notebook, computers
- Instrumentation and industrial control products, such as CDROM, coin changers

## SPECIFICATIONS

### 1.ELECTRICAL

● Contact rating	switching	25mA, 24VDC
	non-switching	100mA
● Contact resistance	100mΩ Max.	
● Insulation resistance	500MΩ Min. at 100VDC	
● Dielectric strength	300VAC Min. for 60 seconds	
● Capacitance between adjacent switches 5pF Max.		



E

Detect

# THS SERIES HALF PITCH SMT TYPE, THE LOWEST PROFILE DIP SWITCH

## 2.MECHANICAL and ENVIRONMENTAL

● Temperature rating	operation	-25°C to +70°C
	storage	-40°C to +85°C
● Operation force		800g Max.
● Mechanical life		1000 operations
● Humidity		95% RH, 40°C for 96Hrs.
● Vibration		10Hz-55Hz-10Hz for 6Hrs.
● Reflow soldering heart for SMT type (reference only)		240°C for 20 seconds or less, peak temperature 260°C or less

Temperature (°C)

Time (sec)

Max. 260°C  
240°C  
180°C  
150°C

120-150 sec  
20 sec Max.

## ■ PART NUMBERING SYSTEM

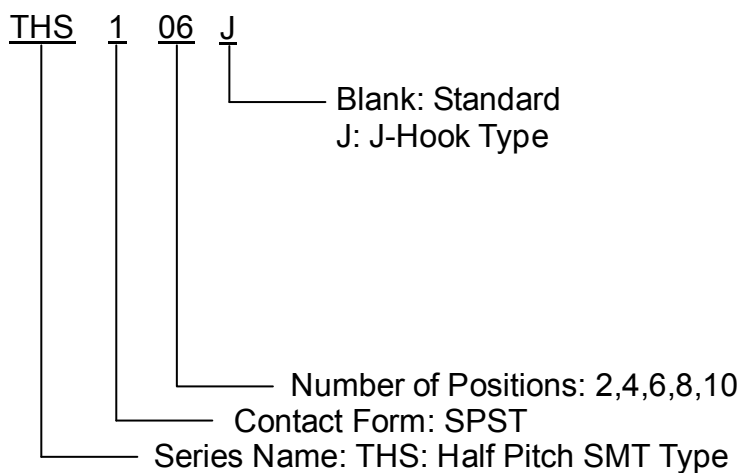

E

Detect

# THS SERIES HALF PITCH SMT TYPE, THE LOWEST PROFILE DIP SWITCH

## CONSTRUCTION

THS

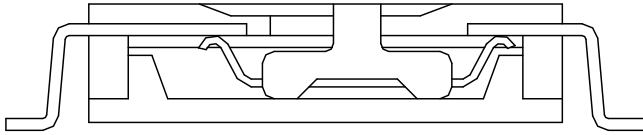

THS1XX

THS J TYPE

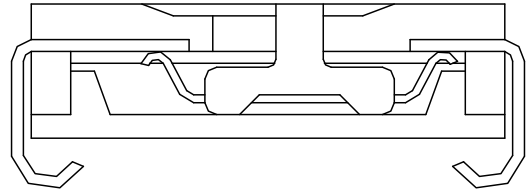

THS1XXJ

## OPTIONS

1. Special marking and case color available

2. Top Tape Sealed



## PACKAGING

1. Tape & Reel Packaging (Per EIA STANDARD)

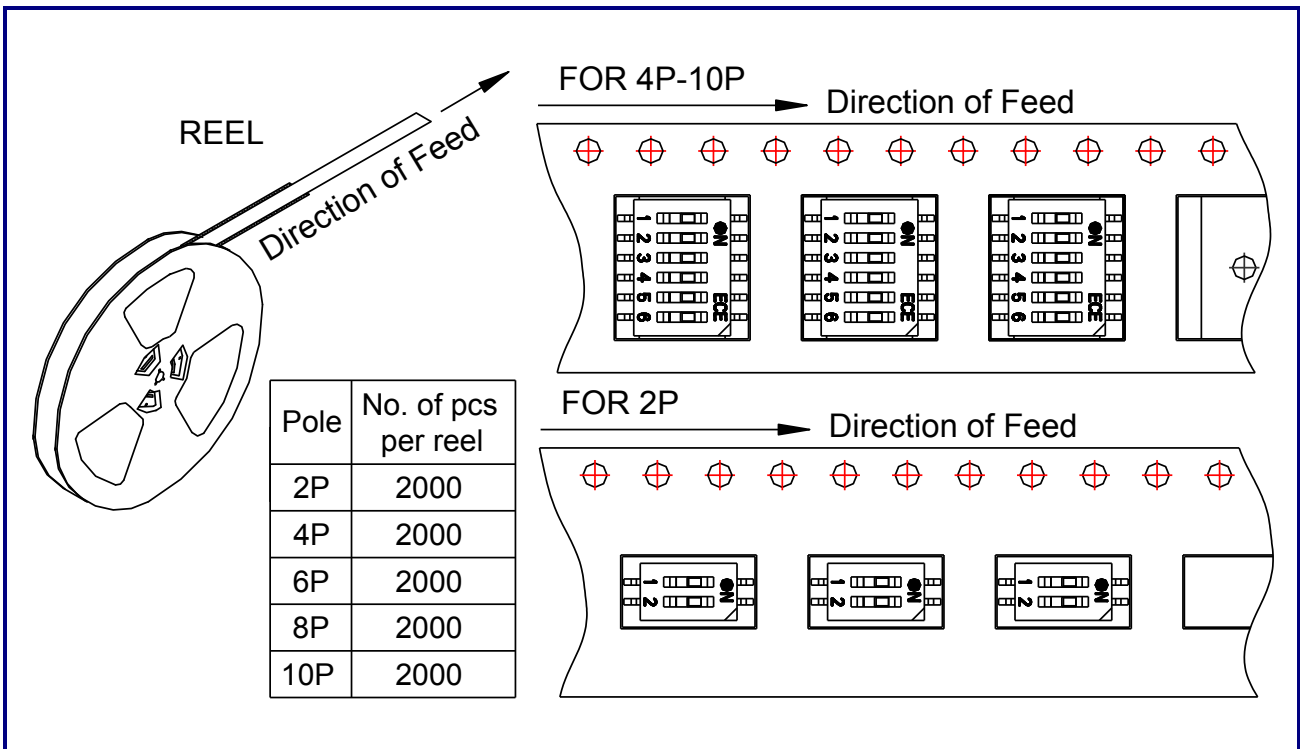

Detect



Dimensions are shown: mm  
Specifications and dimensions subject to change

# THS SERIES HALF PITCH SMT TYPE, THE LOWEST PROFILE DIP SWITCH

## DIMENSIONS AND CIRCUITRY

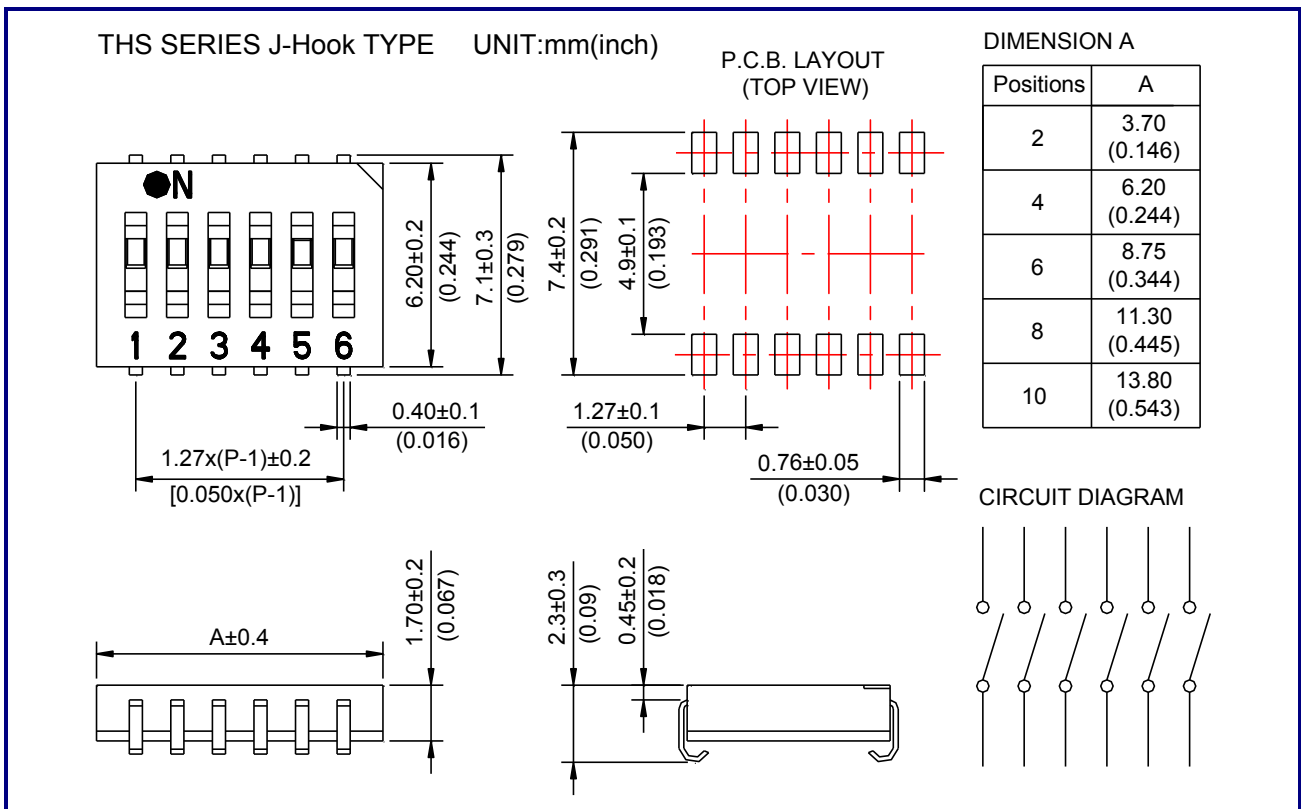
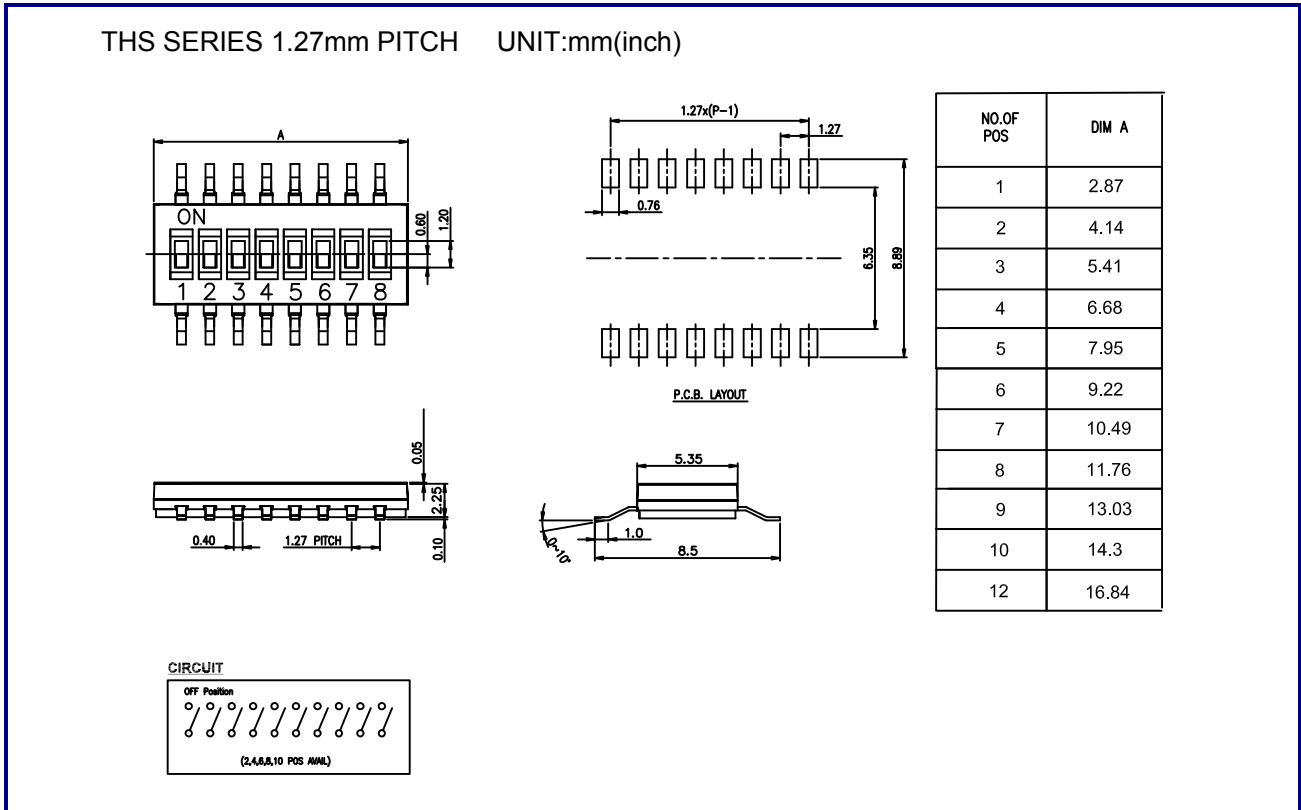

## X-ON Electronics

Largest Supplier of Electrical and Electronic Components

*Click to view similar products for [DIP Switches/SIP Switches](#) category:*

*Click to view products by [ROCPU Technology](#) manufacturer:*

Other Similar products are found below :

[79B10T](#) [8136-475G4T](#) [G7G-1A2-CB-DC12](#) [DRR60016](#) [DRS4016](#) [1825444-1](#) [200183](#) [206002](#) [219-6LPSTRF](#) [25.350.0653.0](#)

[SDA10H1BDA](#) [97R06ST](#) [A2C-2A5](#) [1825058-4](#) [1825444-7](#) [ADE08SA04](#) [ADE12S04](#) [192960010](#) [206005RAS](#) [206007](#) [2-1825058-8](#)

[25.352.0353.0](#) [CXDRIVEV2X](#) [LA2-002-DC24](#) [DSR02T](#) [E2FMX2D1M1TGJ03M](#) [NDI10H](#) [219-9MSTP](#) [EPM02FV](#) [206010RAST](#) [76SB05](#)

[TD06H0SK1](#) [Z7.255.9027.0](#) [1-1825058-3](#) [1825428-4](#) [219-10LPSTF](#) [E3ZG6111D03M](#) [G4D212PUSTV2DC5](#) [EPG301BT06](#) [1-1825058-6](#)

[E3TSL23M5J03M](#) [Y5795](#) [7R0060](#) [HARW0001](#) [ADE07S04](#) [432220096](#) [206005](#) [206006](#) [206010](#) [206005RAST](#)