

CIRCUIT DIAGRAM
电路图

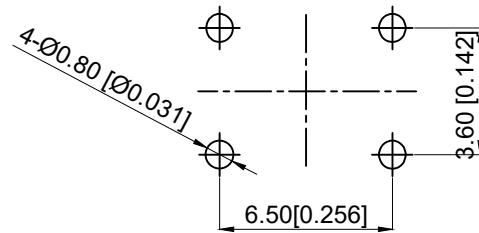

PCB LAND DIMENSION
PCB板焊盘尺寸

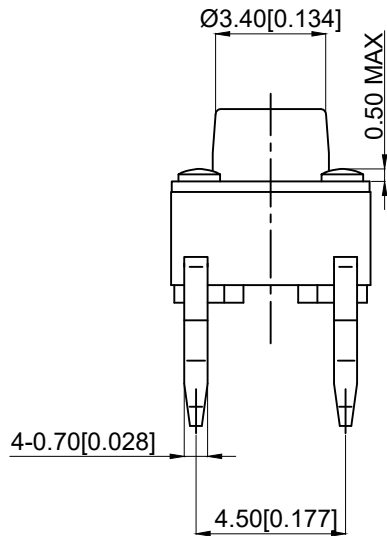
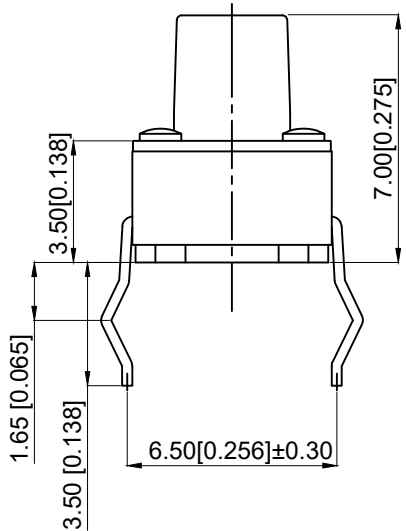

SPECIFICATION

规范
Rating: 50mA.12V DC
额定值: 50mA.12V DC
Insulation resistance: 100MΩ min.100V DC
绝缘电阻: 100MΩ min.100V DC
Dielectric strength: 250V AC for 1 min
介电强度: 250V AC 1分钟
Contact resistance:100mΩ max

Travel: 0.25±0.1mm
行程: 0.25±0.1mm
Lifetime:600000 times
寿命: 600000 times
Operating force:160±50gf
操作力: 160±50gf
Operating temperature rang:-30°Cto + 85°C
工作温度范围: -30°Cto + 85°C

5	Terminal 端子	PA66	1	Ag plating 镀银
4	Base 底座	LCP	1	Black 黑色
3	Contact 弹片	SUS	1	Ag plating 镀银
2	Stem 按钮	PA66	1	Brown 棕色
1	Cover 盖板	Brass 黄铜	1	Ag plating 镀银
NO 序号	Part name 部件名	Material 材料	QTY 数量	Remark 备注

A4				
A3				
A2				
A1				
REV	DATE	REVISION	DESCRIPTION	ISSUE



COMMON TOLERANCE

X.XX	± 0.10
X.X	± 0.15
X	± 0.25

ANGULAR

UNIT	MM	PROJECTED		PRODUCT NAME:
DRAWN BY	FUYUAN	CHECKED BY	COCO	MODEL NO: TP10811670
DATE	2019	APPROVAL B	ALEN	Https: www.rocpcu.tw
ROCPCU TECHNOLOGY CO.,LTD				
Copies are issued in strict confidence and shall not be reproduced or copied, or used as the basic of manufacture or sale of apparatus without permission				

X-ON Electronics

Largest Supplier of Electrical and Electronic Components

Click to view similar products for [Tactile Switches](#) category:

Click to view products by [ROCPU Technology](#) manufacturer:

Other Similar products are found below :

[5GTH92001](#) [5GTH9202242](#) [6407-250V-25273P](#) [ADTSA62NV](#) [ADTSA62RV](#) [B3F-3123](#) [1977177-8](#) [1977266-1](#) [ADTSA63NV](#)
[ADTSM21NSVTR](#) [ADTSM25RVTR](#) [ADTSM32NVTR](#) [ADTSMW64RV](#) [FSMRA4JHA04](#) [GS4.70F300QP](#) [KSC241J SP DELTA LFS](#)
[3FTL600RAS](#) [3FTL640RAS](#) [Y96K132V0FPLFS](#) [5GTH9658222](#) [6407-250V-25343P](#) [ADTSM31NVTR](#) [2-1977120-7](#) [TSJW-5.2-260-TR](#)
[KMT011MNGJLHS](#) [B3WN6002S](#) [70-201.0](#) [ADTSG648NV](#) [ADTSM62KSVTR](#) [ADTSM648NV](#) [95C06E3RAT](#) [5GTH96561](#) [3ATH9Q](#)
[FSMRA8JHA04](#) [HARS0073](#) [Y97HS12A5RAFP](#) [Y97BT23B2HAFP](#) [Y33R411N9FPLFT](#) [Y31C01402FPLFS](#) [PTS645SK50SMTR92](#)
[ADTSM32NVB](#) [KMS233GPWTLFG](#) [Y78B64124FP](#) [PTS638SK25SMTR2LFS](#) [Y96D113G0FP LFS](#) [Y33A812C5FP LFT](#) [Y56B2D120FP](#)
[LFS](#) [PTS645 DVM83-BN125-2 LFS](#) [B3W 1000G](#) [KSC621G OL LFS](#)