

PCB.焊接图
PCB.WELDING DRAWING

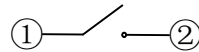

电路图
CIRCUIT DIAGRAM

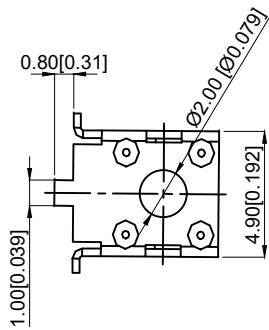
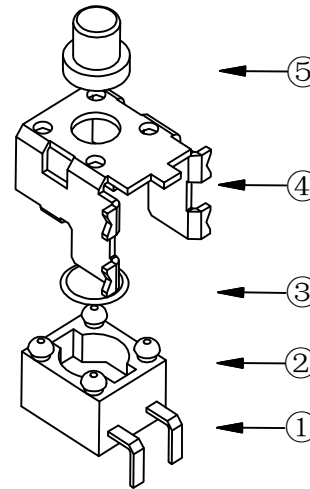
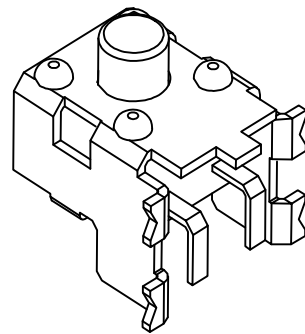
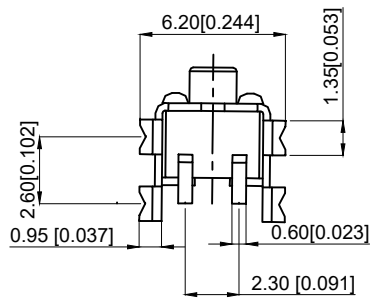

NOTES:

1. Rate voltage: 50mA DC12V
1. 额定电压: 50mA DC12V
2. Contact resistance: $\leq 100m\Omega$
2. 接触电阻; $\leq 100m\Omega$
3. Operating force: $260g \pm 50gf$
3. 按力: $260g \pm 50gf$
4. Travel: $0.20 \pm 0.10mm$
4. 行程: $0.20 \pm 0.10mm$
5. Insulated resistance: $\geq 100m\Omega$
5. 绝缘电阻: $\geq 100m\Omega$
6. Dielectric strength: $\geq 250VAC$
6. 介电强度: $\geq 250VAC$
7. Life: 50000 times
7. 寿命: 50000次
8. Working temperature: $-20^{\circ}C \sim 80^{\circ}C$
8. 工作温度: $-20^{\circ}C \sim 80^{\circ}C$

5	Push-button 按钮	PPA	1	Black 黑色
4	Blind flange 盖板	Iron cover plate	1	Copper tin plating 镀铜锡
3	Shrapnel 弹片	SUS	1	Ag plating 镀银
2	Noumenon 本体	PPA	1	Black 黑色
1	Card 卡件	Brass	1	Ag plating 镀银
NO 序号	Part name 部件名	Material 材料	QTY 数量	Remark 备注

A4				
A3				
A2				
A1				
REV	DATE	REVISION	DESCRIPTION	ISSUE



COMMON TOLERANCE

X.XX	± 0.10
X.X	± 0.15
X	± 0.25
ANGULAR	—

UNIT	MM	PROJECTED		PRODUCT NAME:
DRAWN BY	FUYUAN	CHECKED BY	COCO	MODEL NO: TP12722650
DATE	2019	APPROVAL B	ALEN	Https: www.rocpu.tw
ROCPCU TECHNOLOGY CO.,LTD				
Copies are issued in strict confidence and shall not be reproduced or copied, or used as the basic of manufacture or sale of apparatus without permission				

X-ON Electronics

Largest Supplier of Electrical and Electronic Components

Click to view similar products for [Tactile Switches](#) category:

Click to view products by [ROCPU Technology](#) manufacturer:

Other Similar products are found below :

[5GTH92001](#) [5GTH9202242](#) [6407-250V-25273P](#) [ADTSA62NV](#) [ADTSA62RV](#) [B3F-3123](#) [1977177-8](#) [1977266-1](#) [ADTSA63NV](#)
[ADTSM21NSVTR](#) [ADTSM25RVTR](#) [ADTSM32NVTR](#) [ADTSMW64RV](#) [FSMRA4JHA04](#) [GS4.70F300QP](#) [KSC241J SP DELTA LFS](#)
[3FTL600RAS](#) [3FTL640RAS](#) [Y96K132V0FPLFS](#) [5GTH9658222](#) [ADTSM31NVTR](#) [2-1977120-7](#) [TSJW-5.2-260-TR](#) [KMT011MNGJLHS](#)
[B3WN6002S](#) [70-201.0](#) [ADTSG648NV](#) [ADTSM62KSVTR](#) [ADTSM648NV](#) [95C06E3RAT](#) [5GTH96561](#) [3ATH9Q](#) [FSMRA8JHA04](#)
[HARS0073](#) [Y33R411N9FPLFT](#) [Y31C01402FPLFS](#) [PTS645SK50SMTR92](#) [ADTSM32NVB](#) [KMS233GPWTLFG](#) [Y78B64124FP](#)
[Y96D113G0FP LFS](#) [Y33A812C5FP LFT](#) [Y56B2D120FP LFS](#) [PTS645 DVM83-BN125-2 LFS](#) [B3W 1000G](#) [KSC621G OL LFS](#) [B3F 1002C](#)
[B3F 0047H](#) [B3F 1000G](#) [B3W 1002C](#)