

PCB.焊接图  
PCB.WELDING DRAWING

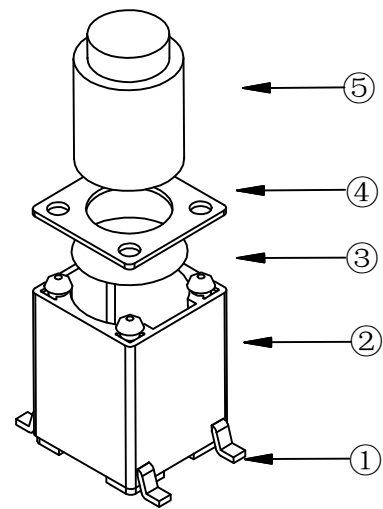

NOTES:

- 1.Rat voltage: 50mA DC12V
- 1.额定电流:50mA DC12V
- 2.Contact Resistance:≤100mΩ
- 2.接触电阻: ≤100mΩ
- 3.Operating force:260g±50gf
- 3.按力: 260g±50gf
- 4.Travel: 0.25±0.1mm
- 4..行程: 0.25 + 0.1mm
- 5.Insulation Resistance:≥100MΩ
- 5.绝缘电阻: ≥100MΩ
- 6.Dielectric strength: ≥250VAC
- 6.介电强度: ≥250VAC
- 7.Life: 200,000 times
- 7.寿命: 200,000 times
- 8.Operating Temperature:-20 to ~80℃
- 8.使用温度: -20 to ~80℃

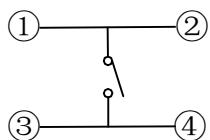
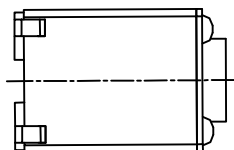
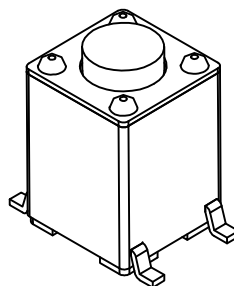
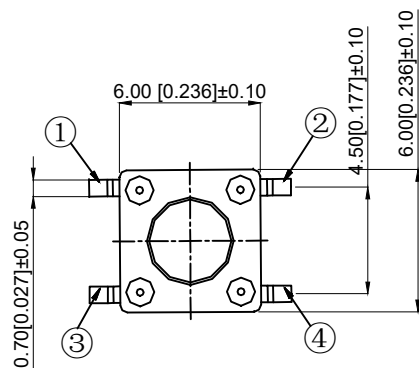

电路图  
CIRCUIT DRAMAG

5	Push-button 按钮	PPA	1	Black 黑色
4	Blind flange 盖板	Iron cover plate 铁盖板	1	Copper tin plating 镀铜锡
3	Shrapnel 弹片	SUS	1	Ag plating 镀银
2	Noumenon 本体	PPA	1	Black 黑色
1	Card 卡件	Brass	1	Ag plating 镀银
NO 序号	Part name 部件名	Material 材料	QTY 数量	Remark 备注

A4				<p>台普 ROCPCU</p>	COMMON TOLERANCE	UNIT	MM	PROJECTED		PRODUCT NAME:
A3						DRAWN BY	FUYUAN	CHECKED BY	COCO	MODEL NO: TP12922614
A2					DATE	2019	APPROVAL B	ALEN	Https: www.rocpcu.tw	
A1					<b>ROCPCU TECHNOLOGY CO.,LTD</b>					
REV	DATE	REVISION	DESCRIPTION		ISSUE	ANGULAR	Copies are issued in strict confidence and shall not be reproduced or copied, or used as the basic of manufacture or sale of apparatus without permission			

## X-ON Electronics

Largest Supplier of Electrical and Electronic Components

*Click to view similar products for [Tactile Switches](#) category:*

*Click to view products by [ROCPU Technology](#) manufacturer:*

Other Similar products are found below :

[5GTH92001](#) [5GTH9202242](#) [6407-250V-25273P](#) [ADTSA62NV](#) [ADTSA62RV](#) [B3F-3123](#) [1977177-8](#) [1977266-1](#) [ADTSA63NV](#)  
[ADTSM21NSVTR](#) [ADTSM25RVTR](#) [ADTSM32NVTR](#) [ADTSMW64RV](#) [FSMRA4JHA04](#) [GS4.70F300QP](#) [KSC241J SP DELTA LFS](#)  
[3FTL600RAS](#) [3FTL640RAS](#) [Y96K132V0FPLFS](#) [5GTH9658222](#) [6407-250V-25343P](#) [ADTSM31NVTR](#) [2-1977120-7](#) [TSJW-5.2-260-TR](#)  
[KMT011MNGJLHS](#) [B3WN6002S](#) [70-201.0](#) [ADTSG648NV](#) [ADTSM62KSVTR](#) [ADTSM648NV](#) [95C06E3RAT](#) [5GTH96561](#) [3ATH9Q](#)  
[FSMRA8JHA04](#) [HARS0073](#) [Y97HS12A5RAFP](#) [Y97BT23B2HAFP](#) [Y33R411N9FPLFT](#) [Y31C01402FPLFS](#) [PTS645SK50SMTR92](#)  
[ADTSM32NVB](#) [KMS233GPWTLFG](#) [Y78B64124FP](#) [PTS638SK25SMTR2LFS](#) [Y96D113G0FP LFS](#) [Y33A812C5FP LFT](#) [Y56B2D120FP](#)  
[LFS](#) [PTS645 DVM83-BN125-2 LFS](#) [B3W 1000G](#) [KSC621G OL LFS](#)