

Main technical specifications:

主要技术规格:

1. Rated value: 50mA DC12V
1. 额定值: 50mA DC12V
2. Contact resistance: ≤ 50m Ω
2. 接触电阻: ≤50mΩ
3. Operating force: 260 ± 30gf
3. 操作力: 260±30gf
4. Stroke: 0.30 ± 0.1mm
4. 行程: 0.30±0.1mm
5. Insulation resistance: ≥ 100m Ω
5. 绝缘电阻: ≥100MΩ
6. Electric strength: 250V 50Hz 1min
6. 抗电强度: 250V 50HZ 1Min.
7. Service life: 100000 cycles
7. 寿命: 100,000 Cycles
8. Waterproof grade: IP67
8. 防水等级: IP67
9. Anti silver migration: 60V, 85 °C, 90% RH / 60H
9. 防银迁移: 60V, 85°C, 90%RH/60H
10. Working temperature: - 40 °C to + 85 °C
10. 工作温度: -40°C to + 85°C

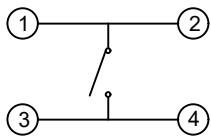
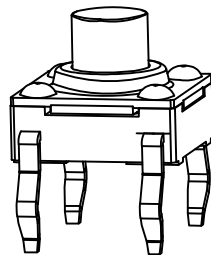
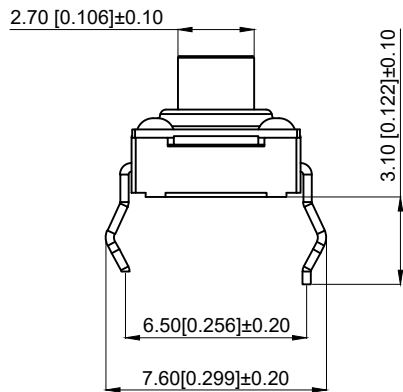

Circuit diagram

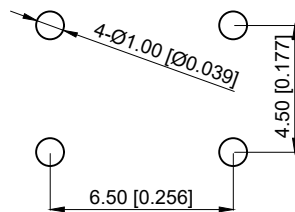

PCB welding diagram

6	Terminal 端子	Brass 黄铜	1	Ag plating 镀银
5	Base 基座	PPA	1	Black 黑色
4	Contact 弹片	SUS	1	Ag plating 镀银
3	Waterproof pad 防水垫	Silica gel 硅胶	1	Black 黑色
2	Cover 盖板	SUS	1	
1	Stem 按钮	PPA	1	Black 黑色
NO 序号	Part name 部件名	Material 材料	QTY 数量	Remark 备注

A4				
A3				
A2				
A1				
REV	DATE	REVISION	DESCRIPTION	ISSUE



COMMON TOLERANCE

X.XX	± 0.10
X.X	± 0.15
X	± 0.25

ANGULAR

UNIT	MM	PROJECTED		PRODUCT NAME:
DRAWN BY	FUYUAN	CHECKED BY	COCO	MODEL NO: TPF16LS-DC70
DATE	2019	APPROVAL B	ALEN	Https: www.rocpcu.tw
<b>ROCPCU TECHNOLOGY CO.,LTD</b>				
Copies are issued in strict confidence and shall not be reproduced or copied, or used as the basic of manufacture or sale of apparatus without permission				

## X-ON Electronics

Largest Supplier of Electrical and Electronic Components

*Click to view similar products for [Tactile Switches](#) category:*

*Click to view products by [ROCPU Technology](#) manufacturer:*

Other Similar products are found below :

[6407-250V-25273P](#) [ADTSA62NV](#) [B3F-3123](#) [1977177-8](#) [1977266-1](#) [ADTSA63NV](#) [ADTSM21NSVTR](#) [ADTSM25RVTR](#) [ADTSM32NVTR](#)  
[ADTSMW64RV](#) [1977120-6](#) [FSMRA4JHA04](#) [GS4.70F300QP](#) [KSC241J SP DELTA LFS](#) [3FTL600RAS](#) [3FTL640RAS](#) [6407-250V-25343P](#)  
[ADTSM31NVTR](#) [2-1977120-7](#) [TSJW-5.2-260-TR](#) [Y651050400P](#) [KMT011MNGJLHS](#) [70-201.0](#) [ADTSG648NV](#) [ADTSM62KSVTR](#)  
[ADTSM648NV](#) [95C06E3RAT](#) [3ATH9Q](#) [FSMRA8JHA04](#) [HARS0073](#) [Y33R411N9FPLFT](#) [Y33R51139FPLFT](#) [Y31C01402FPLFS](#)  
[PTS645SK50SMTR92](#) [ADTSM32NVB](#) [KMS233GPWTLFG](#) [Y78B64124FP](#) [Y31CJ244KFP LFS](#) [Y96D113G0FP LFS](#) [Y33A812C5FP LFT](#)  
[Y56B2D120FP LFS](#) [Y31C5144KFP LFS](#) [PTS645 DVM83-BN125-2 LFS](#) [B3W 1000G](#) [KSC621G OL LFS](#) [B3F 1002C](#) [B3F 0047H](#) [B3W](#)  
[1002C](#) [B3F 5001G](#) [B3W 1100C](#)