

●Absolute Maximum Rating (Ta=25°C)

BA78□□CP/FP, BA78M□□CP/FP

| Parameter | Symbol | Limits | Unit |
|--------------------------------------|--------|-------------------|------|
| Power supply voltage | Vin | 35 | V |
| Power Dissipation 1 | Pd1 | 2 ^{*1} | W |
| | | 1 ^{*1} | |
| Power Dissipation 2 | Pd2 | 22 ^{*2} | W |
| | | 10 ^{*2} | |
| Output Current | Io | 1 ^{*3} | A |
| | | 0.5 ^{*3} | |
| Operating Temperature Range | Topr | -40~+85 | °C |
| Storage Temperature Range | Tstg | -55~+150 | °C |
| Operating Junction Temperature Range | Tj | -40~+150 | °C |

*1 Derating in done 16mW/°C(TO220CP-3), 8mW/°C(TO252-3) for temperatures above Ta=25°C

*2 Derating in done 176mW/°C(TO220CP-3), 80mW/°C(TO252-3) for temperatures above Ta=25°C, Mounted on infinity Aluminium heat sink.

*3 Pd,ASO and Tjmax(150°C) should not be exceeded.

●Operating Conditions(Ta=25°C, Pd should not be exceeded)

BA78□□CP/FP

| Parameter | Symbol | Min. | Max. | Unit. |
|----------------|--------|------|------|-------|
| Input Voltage | Vin | 7.5 | 25 | V |
| | | 8.5 | 21 | |
| | | 9.5 | 22 | |
| | | 10.5 | 23 | |
| | | 11.5 | 26 | |
| | | 12.5 | 25 | |
| | | 14.5 | 27 | |
| | | 17.5 | 30 | |
| | | 21 | 33 | |
| | | 23 | 33 | |
| 27 | 33 | | | |
| Output Current | Io | - | 1 | A |

BA78M□□CP/FP

| Parameter | Symbol | Min. | Max. | Unit. |
|---------------|--------|----------------|------|-------|
| Input Voltage | Vin | 7.5 | 25 | V |
| | | 8.5 | 21 | |
| | | 9.5 | 22 | |
| | | 10.5 | 23 | |
| | | 11.5 | 26 | |
| | | 12.5 | 25 | |
| | | 14.5 | 27 | |
| | | 17.5 | 30 | |
| | | 21 | 33 | |
| | | 23 | 33 | |
| | | 27 | 33 | |
| | | Output Current | Io | |

●Electrical Characteristics BA78M□□CP/FP

(Ta=25°C, Vin=10V(05),11V(06),13V(07),14V(08),15V(09),16V(10),19V(12),23V(15),27V(18),29V(20),33V(24), Io=350mA unless otherwise specified)

| Parameter | Symbol | Type | Limit | | | Unit | Condition |
|---|--------|-------------------|-------|------|-------|-------|------------------------------|
| | | | Min | Typ | Max | | |
| Output Voltage 1 | Vo1 | 05 | 4.8 | 5.0 | 5.2 | V | Io=350mA |
| | | 06 | 5.75 | 6.0 | 6.25 | | |
| | | 07 | 6.7 | 7.0 | 7.3 | | |
| | | 08 | 7.7 | 8.0 | 8.3 | | |
| | | 09 | 8.6 | 9.0 | 9.4 | | |
| | | 10 | 9.6 | 10.0 | 10.4 | | |
| | | 12 | 11.5 | 12.0 | 12.5 | | |
| | | 15 | 14.4 | 15.0 | 15.6 | | |
| | | 18 | 17.3 | 18.0 | 18.7 | | |
| Output Voltage 2 | Vo2 | 05 | 4.75 | - | 5.25 | V | Vin=7.5~20V, Io=5mA~350mA |
| | | 06 | 5.7 | - | 6.3 | | Vin=8.5~21V, Io=5mA~350mA |
| | | 07 | 6.65 | - | 7.35 | | Vin=9.5~22V, Io=5mA~350mA |
| | | 08 | 7.6 | - | 8.4 | | Vin=10.5~23V, Io=5mA~350mA |
| | | 09 | 8.55 | - | 9.45 | | Vin=11.5~24V, Io=5mA~350mA |
| | | 10 | 9.5 | - | 10.5 | | Vin=12.5~25V, Io=5mA~350mA |
| | | 12 | 11.4 | - | 12.6 | | Vin=15~27V, Io=5mA~350mA |
| | | 15 | 14.25 | - | 15.75 | | Vin=17.5~30V, Io=5mA~350mA |
| | | 18 | 17.1 | - | 18.9 | | Vin=21~33V, Io=5mA~350mA |
| Line Regulation 1 | Reg.I1 | 05 | - | 3 | 100 | mV | Vin=7~25V, Io=200mA |
| | | 06 | - | 3 | 100 | | Vin=8~25V, Io=200mA |
| | | 07 | - | 4 | 100 | | Vin=9~25V, Io=200mA |
| | | 08 | - | 4 | 100 | | Vin=10.5~25V, Io=200mA |
| | | 09 | - | 4 | 100 | | Vin=11.5~26V, Io=200mA |
| | | 10 | - | 5 | 100 | | Vin=12.5~28V, Io=200mA |
| | | 12 | - | 5 | 100 | | Vin=14.5~30V, Io=200mA |
| | | 15 | - | 6 | 100 | | Vin=17.5~30V, Io=200mA |
| | | 18 | - | 7 | 100 | | Vin=21~33V, Io=200mA |
| Line Regulation 2 | Reg.I2 | 05 | - | 1 | 50 | mV | Vin=8~12V, Io=200mA |
| | | 06 | - | 1 | 50 | | Vin=9~25V, Io=200mA |
| | | 07 | - | 1 | 50 | | Vin=10~25V, Io=200mA |
| | | 08 | - | 1 | 50 | | Vin=11~25V, Io=200mA |
| | | 09 | - | 2 | 50 | | Vin=12~25V, Io=200mA |
| | | 10 | - | 2 | 50 | | Vin=14~26V, Io=200mA |
| | | 12 | - | 3 | 50 | | Vin=16~30V, Io=200mA |
| | | 15 | - | 3 | 50 | | Vin=20~30V, Io=200mA |
| | | 18 | - | 3 | 50 | | Vin=24~33V, Io=200mA |
| Ripple Rejection | R.R. | 05 | 62 | 78 | - | dB | ein=1Vrms, f=120Hz, Io=100mA |
| | | 06 | 60 | 74 | - | | |
| | | 07 | 57 | 71 | - | | |
| | | 08 | 56 | 69 | - | | |
| | | 09 | 56 | 67 | - | | |
| | | 10 | 56 | 66 | - | | |
| | | 12 | 55 | 63 | - | | |
| | | 15 | 54 | 60 | - | | |
| | | 18 | 53 | 58 | - | | |
| Temperature Coefficient of Output Voltage | Tcvo | 05 | - | -1.0 | - | mV/°C | Io=5mA, Tj=0~125°C |
| | | 06/07/08/09/10/12 | - | -0.5 | - | | |
| | | 15/18 | - | -0.6 | - | | |
| | | 20/24 | - | -0.7 | - | | |
| Peak Output Current | Io-p | common | - | 875 | - | mA | Tj=25°C |
| Dropout Voltage | Vd | common | - | 2.0 | - | V | Io=500mA |

●Electrical Characteristics BA78M□□CP/FP

(Ta=25°C, Vin=10V(05),11V(06),13V(07),14V(08),15V(09),16V(10),19V(12),23V(15),27V(18),29V(20),33V(24),Io=350mA unless otherwise specified)

| Parameter | Symbol | Type | Limit | | | Unit | Condition |
|------------------------------|--------|----------------------|-------|------|-----|------|------------------------|
| | | | Min | Typ | Max | | |
| Load Regulation 1 | Reg.L1 | 05 | - | 20 | 100 | mV | Io=5mA~500mA |
| | | 06 | - | 20 | 120 | | |
| | | 07 | - | 20 | 140 | | |
| | | 08 | - | 20 | 160 | | |
| | | 09 | - | 20 | 180 | | |
| | | 10 | - | 20 | 200 | | |
| | | 12 | - | 20 | 240 | | |
| | | 15 | - | 20 | 300 | | |
| | | 18 | - | 20 | 360 | | |
| | | 20 | - | 20 | 400 | | |
| Load Regulation 2 | Reg.L2 | 05 | - | 10 | 50 | mV | Io=5mA~200mA |
| | | 06 | - | 10 | 60 | | |
| | | 07 | - | 10 | 70 | | |
| | | 08 | - | 10 | 80 | | |
| | | 09 | - | 10 | 90 | | |
| | | 10 | - | 10 | 100 | | |
| | | 12 | - | 10 | 120 | | |
| | | 15 | - | 10 | 150 | | |
| | | 18 | - | 10 | 180 | | |
| | | 20 | - | 10 | 200 | | |
| Output Noise Voltage | Vn | 05 | - | 40 | - | μV | f=10Hz~100kHz |
| | | 06 | - | 60 | - | | |
| | | 07 | - | 70 | - | | |
| | | 08 | - | 80 | - | | |
| | | 09 | - | 90 | - | | |
| | | 10 | - | 100 | - | | |
| | | 12 | - | 110 | - | | |
| | | 15 | - | 130 | - | | |
| | | 18 | - | 140 | - | | |
| | | 20 | - | 150 | - | | |
| Bias Current | Ib | common | - | 4.5 | 6.0 | mA | Io=0mA |
| Bias Current Change1 | Ib1 | common | - | - | 0.5 | mA | Io=5mA~350mA |
| Bias Current Change 2 | Ib2 | 05 | - | - | 0.8 | mA | Vin:8~25V, Io=200mA |
| | | 06 | - | - | 0.8 | | Vin:9~25V, Io=200mA |
| | | 07 | - | - | 0.8 | | Vin:10~25V, Io=200mA |
| | | 08 | - | - | 0.8 | | Vin:10.5~25V, Io=200mA |
| | | 09 | - | - | 0.8 | | Vin:12~25V, Io=200mA |
| | | 10 | - | - | 0.8 | | Vin:13~25V, Io=200mA |
| | | 12 | - | - | 0.8 | | Vin:14.5~30V, Io=200mA |
| | | 15 | - | - | 0.8 | | Vin:17.5~30V, Io=200mA |
| | | 18 | - | - | 0.8 | | Vin:21~33V, Io=200mA |
| | | 20 | - | - | 0.8 | | Vin:23~33V, Io=200mA |
| Short-Circuit Output Current | Ios | 05/06/07/08 | - | 0.4 | - | A | Vin=25V |
| | | 09/10/12/15/18/20/24 | - | 0.17 | - | | Vin=30V |
| Output Resistance | Ro | 05 | - | 9 | - | mΩ | f=1kHz |
| | | 06 | - | 10 | - | | |
| | | 07 | - | 11 | - | | |
| | | 08 | - | 12 | - | | |
| | | 09 | - | 13 | - | | |
| | | 10 | - | 14 | - | | |
| | | 12 | - | 16 | - | | |
| | | 15 | - | 19 | - | | |
| | | 18 | - | 22 | - | | |
| | | 20 | - | 25 | - | | |
| 24 | - | 37 | - | | | | |

●Electrical Characteristics BA78□□CP/FP

(Ta=25°C, Vin=10V(05),11V(06),13V(07),14V(08),15V(09),16V(10),19V(12),23V(15),27V(18),29V(20),33V(24),Io=500mA unless otherwise specified)

| Parameter | Symbol | Type | Limit | | | Unit | Condition |
|---|--------|-------------------|-------|-----------------------|-------|-------|------------------------------|
| | | | Min | Typ | Max | | |
| Output Voltage 1 | Vo1 | 05 | 4.8 | 5.0 | 5.2 | V | Io=500mA |
| | | 06 | 5.75 | 6.0 | 6.25 | | |
| | | 07 | 6.7 | 7.0 | 7.3 | | |
| | | 08 | 7.7 | 8.0 | 8.3 | | |
| | | 09 | 8.6 | 9.0 | 9.4 | | |
| | | 10 | 9.6 | 10.0 | 10.4 | | |
| | | 12 | 11.5 | 12.0 | 12.5 | | |
| | | 15 | 14.4 | 15.0 | 15.6 | | |
| | | 18 | 17.3 | 18.0 | 18.7 | | |
| | | 20 | 19.2 | 20.0 | 20.8 | | |
| 24 | 23.0 | 24.0 | 25.0 | | | | |
| Output Voltage 2 | Vo2 | 05 | 4.75 | - | 5.25 | V | Vin=7.5~20V, Io=5mA~1A |
| | | 06 | 5.7 | - | 6.3 | | Vin=8.5~21V, Io=5mA~1A |
| | | 07 | 6.65 | - | 7.35 | | Vin=9.5~22V, Io=5mA~1A |
| | | 08 | 7.6 | - | 8.4 | | Vin=10.5~23V, Io=5mA~1A |
| | | 09 | 8.55 | - | 9.45 | | Vin=11.5~26V, Io=5mA~1A |
| | | 10 | 9.5 | - | 10.5 | | Vin=12.5~25V, Io=5mA~1A |
| | | 12 | 11.4 | - | 12.6 | | Vin=15~27V, Io=5mA~1A |
| | | 15 | 14.25 | - | 15.75 | | Vin=17.5~30V, Io=5mA~1A |
| | | 18 | 17.1 | - | 18.9 | | Vin=21~33V, Io=5mA~1A |
| | | 20 | 19.0 | - | 21.0 | | Vin=23~33V, Io=5mA~1A |
| 24 | 22.8 | - | 25.2 | Vin=27~33V, Io=5mA~1A | | | |
| Line Regulation 1 | Reg.I1 | 05 | - | 3 | 100 | mV | Vin=7~25V, Io=500mA |
| | | 06 | - | 4 | 120 | | Vin=8~25V, Io=500mA |
| | | 07 | - | 5 | 140 | | Vin=9~25V, Io=500mA |
| | | 08 | - | 5 | 160 | | Vin=10.5~25V, Io=500mA |
| | | 09 | - | 6 | 180 | | Vin=11.5~26V, Io=500mA |
| | | 10 | - | 7 | 200 | | Vin=12.5~27V, Io=500mA |
| | | 12 | - | 8 | 240 | | Vin=14.5~30V, Io=500mA |
| | | 15 | - | 9 | 300 | | Vin=17.5~30V, Io=500mA |
| | | 18 | - | 10 | 360 | | Vin=21~33V, Io=500mA |
| | | 20 | - | 12 | 400 | | Vin=23~33V, Io=500mA |
| 24 | - | 15 | 480 | Vin=27~33V, Io=500mA | | | |
| Line Regulation 2 | Reg.I2 | 05 | - | 1 | 50 | mV | Vin=8~12V, Io=500mA |
| | | 06 | - | 2 | 60 | | Vin=9~13V, Io=500mA |
| | | 07 | - | 2 | 70 | | Vin=10~15V, Io=500mA |
| | | 08 | - | 3 | 80 | | Vin=11~17V, Io=500mA |
| | | 09 | - | 4 | 90 | | Vin=13~19V, Io=500mA |
| | | 10 | - | 4 | 100 | | Vin=14~20V, Io=500mA |
| | | 12 | - | 5 | 120 | | Vin=16~22V, Io=500mA |
| | | 15 | - | 5 | 150 | | Vin=20~26V, Io=500mA |
| | | 18 | - | 5 | 180 | | Vin=24~30V, Io=500mA |
| | | 20 | - | 7 | 200 | | Vin=26~32V, Io=500mA |
| 24 | - | 10 | 240 | Vin=30~33V, Io=500mA | | | |
| Ripple Rejection | R.R. | 05 | 62 | 78 | - | dB | ein=1Vrms, f=120Hz, Io=100mA |
| | | 06 | 59 | 73 | - | | |
| | | 07 | 57 | 69 | - | | |
| | | 08 | 56 | 65 | - | | |
| | | 09 | 56 | 64 | - | | |
| | | 10 | 55 | 64 | - | | |
| | | 12 | 55 | 63 | - | | |
| | | 15 | 54 | 62 | - | | |
| | | 18 | 53 | 61 | - | | |
| | | 20 | 53 | 60 | - | | |
| 24 | 50 | 58 | - | | | | |
| Temperature Coefficient of Output Voltage | Tcvo | 05 | - | -1.0 | - | mV/°C | Io=5mA, Tj=0~125°C |
| | | 06/07/08/09/10/12 | - | -0.5 | - | | |
| | | 15/18 | - | -0.6 | - | | |
| | | 20/24 | - | -0.7 | - | | |
| Peak Output Current | Io-p | common | - | 1.7 | - | A | Tj=25°C |
| Dropout Voltage | Vd | common | - | 2.0 | - | V | Io=1A |

●Electrical Characteristics BA78□□CP/FP

(Ta=25°C,Vin=10V(05),11V(06),13V(07),14V(08),15V(09),16V(10),19V(12),23V(15),27V(18),29V(20),33V(24),Io=500mA unless otherwise specified)

| Parameter | Symbol | Type | Limit | | | Unit | Condition |
|------------------------------|--------|----------------------|-------|-----|-----|------|------------------------|
| | | | Min | Typ | Max | | |
| Load Regulation 1 | Reg.L1 | 05 | - | 15 | 100 | mV | Io=5mA~1A |
| | | 06 | - | 16 | 120 | | |
| | | 07 | - | 17 | 140 | | |
| | | 08 | - | 19 | 160 | | |
| | | 09 | - | 20 | 180 | | |
| | | 10 | - | 21 | 200 | | |
| | | 12 | - | 23 | 200 | | |
| | | 15 | - | 27 | 300 | | |
| | | 18 | - | 30 | 360 | | |
| | | 20 | - | 32 | 400 | | |
| Load Regulation 2 | Reg.L2 | 05 | - | 5 | 50 | mV | Io=250mA~750mA |
| | | 06 | - | 6 | 60 | | |
| | | 07 | - | 6 | 70 | | |
| | | 08 | - | 7 | 80 | | |
| | | 09 | - | 8 | 90 | | |
| | | 10 | - | 8 | 90 | | |
| | | 12 | - | 10 | 100 | | |
| | | 15 | - | 10 | 150 | | |
| | | 18 | - | 12 | 180 | | |
| | | 20 | - | 14 | 200 | | |
| Output Noise Voltage | Vn | 05 | - | 40 | - | μV | f=10Hz~100kHz |
| | | 06 | - | 60 | - | | |
| | | 07 | - | 70 | - | | |
| | | 08 | - | 80 | - | | |
| | | 09 | - | 90 | - | | |
| | | 10 | - | 100 | - | | |
| | | 12 | - | 110 | - | | |
| | | 15 | - | 125 | - | | |
| | | 18 | - | 140 | - | | |
| | | 20 | - | 150 | - | | |
| Bias Current | Ib | common | - | 4.5 | 8.0 | mA | Io=0mA |
| Bias Current Change 1 | Ib1 | common | - | - | 0.5 | mA | Io=5mA~1A |
| Bias Current Change 2 | Ib2 | 05 | - | - | 0.8 | mA | Vin:8~25V, Io=500mA |
| | | 06 | - | - | 0.8 | | Vin:8.5~25V, Io=500mA |
| | | 07 | - | - | 0.8 | | Vin:9.5~25V, Io=500mA |
| | | 08 | - | - | 0.8 | | Vin:10.5~25V, Io=500mA |
| | | 09 | - | - | 0.8 | | Vin:11.5~26V, Io=500mA |
| | | 10 | - | - | 0.8 | | Vin:12.5~27V, Io=500mA |
| | | 12 | - | - | 0.8 | | Vin:14.5~30V, Io=500mA |
| | | 15 | - | - | 0.8 | | Vin:17.5~30V, Io=500mA |
| | | 18 | - | - | 0.8 | | Vin:21~33V, Io=500mA |
| | | 20 | - | - | 0.8 | | Vin:23~33V, Io=500mA |
| Short-Circuit Output Current | Ios | 05/06/07/08 | - | 0.6 | - | A | Vin=25V |
| | | 09/10/12/15/18/20/24 | - | 0.3 | - | | Vin=30V |
| Output Resistance | Ro | 05 | - | 9 | - | mΩ | f=1kHz |
| | | 06 | - | 10 | - | | |
| | | 07 | - | 10 | - | | |
| | | 08 | - | 10 | - | | |
| | | 09 | - | 10 | - | | |
| | | 10 | - | 11 | - | | |
| | | 12 | - | 12 | - | | |
| | | 15 | - | 14 | - | | |
| | | 18 | - | 17 | - | | |
| | | 20 | - | 19 | - | | |
| 24 | - | 27 | - | | | | |

●BA78M□□ Characteristics data (Ta=25°C, Vin=10V(05), 14V(08), 23V(15) unless otherwise specified)

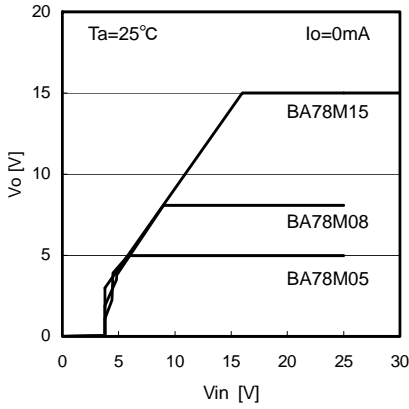

Fig.1 Line Regulation (Io=0mA)

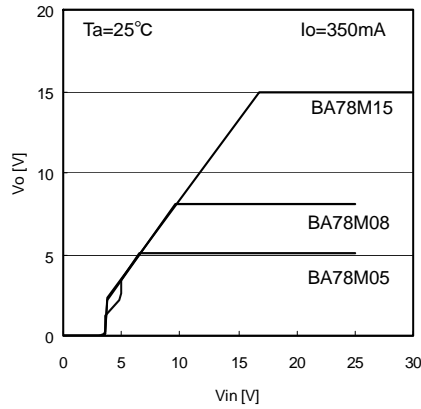

Fig.2 Line Regulation (Io=350mA)

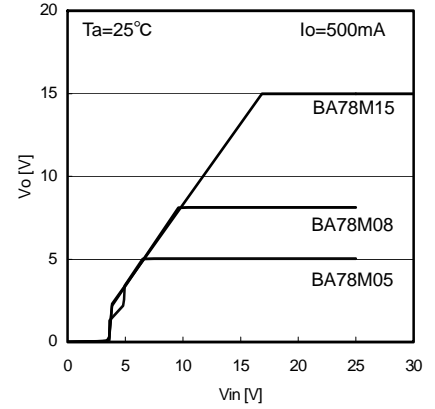

Fig.3 Line Regulation (Io=500mA)

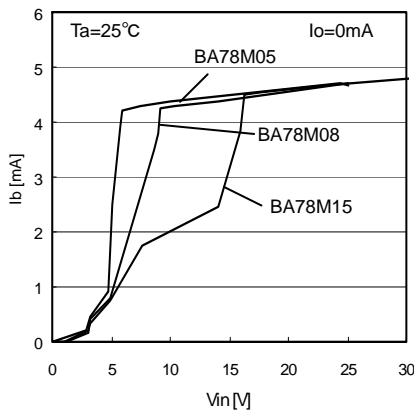

Fig.4 Vin - Ib

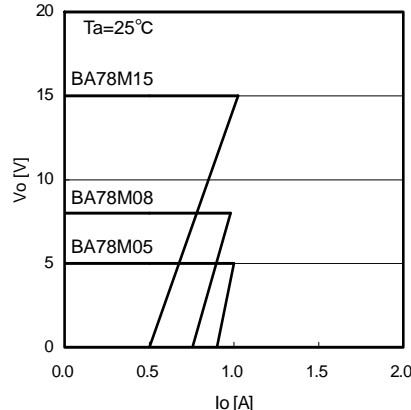

Fig.5 Load Regulation

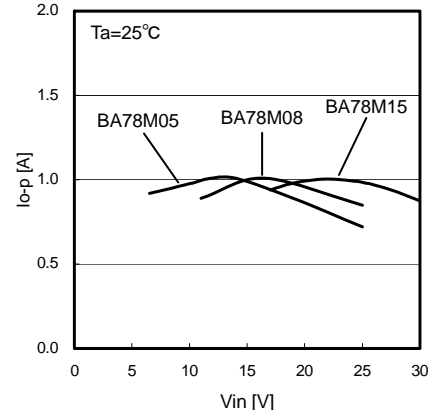

Fig.6 Peak Output Current

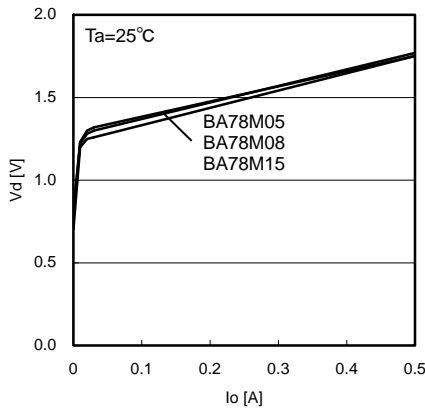

Fig.7 Dropout Voltage

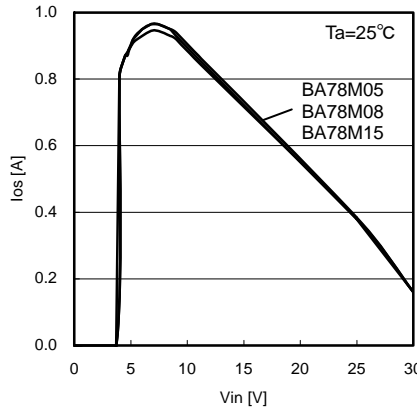

Fig.8 Short - Circuit Output Current

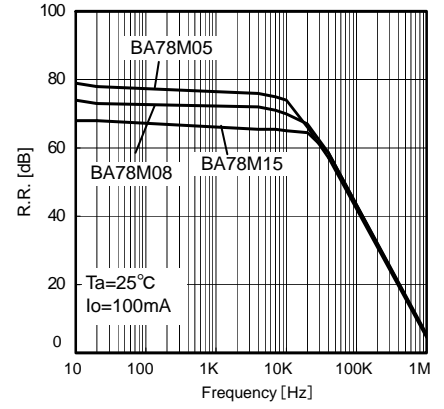

Fig.9 Ripple Rejection Ratio

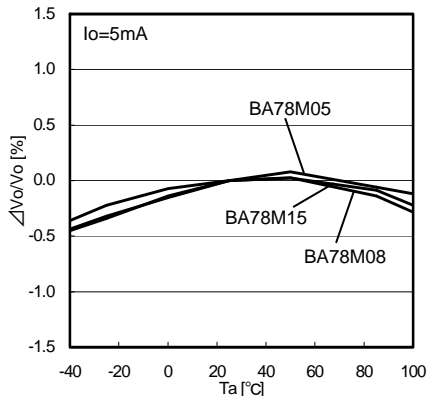

Fig.10 Ta - Vo

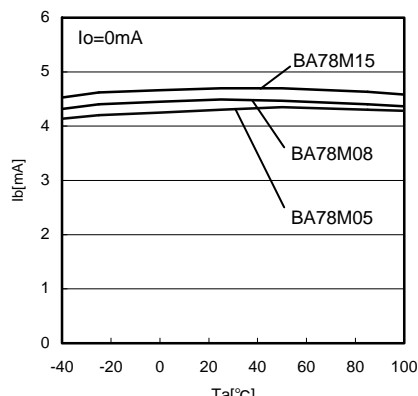

Fig.11 Ta - Ib

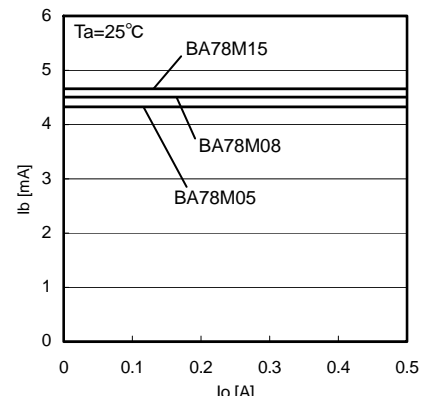

Fig.12 Io - Ib

●BA78□□ Characteristics data (Ta=25°C, Vin=10V(05), 14V(08), 23V(15) unless otherwise specified)

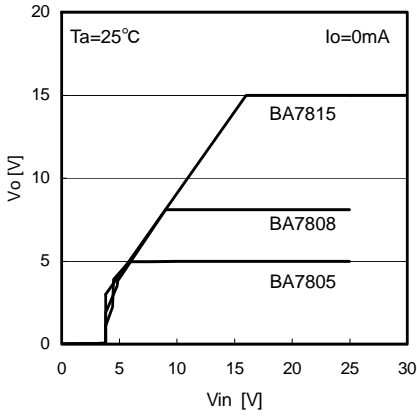

Fig.13 Line Regulation (Io=0mA)

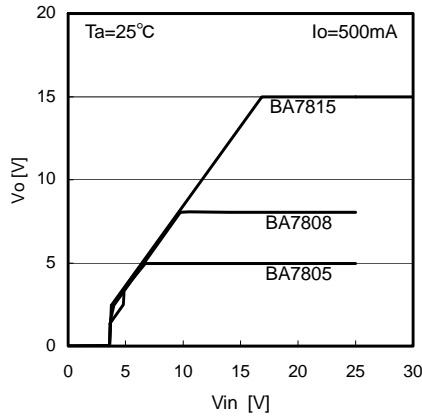

Fig.14 Line Regulation (Io=500mA)

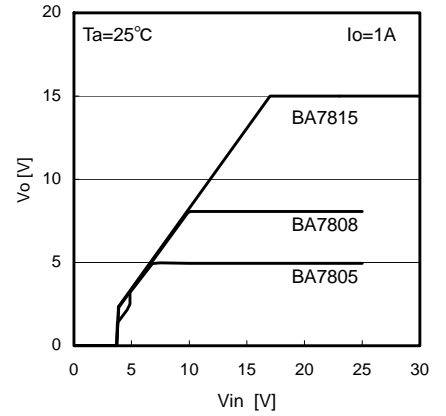

Fig.15. Line Regulation (Io=1A)

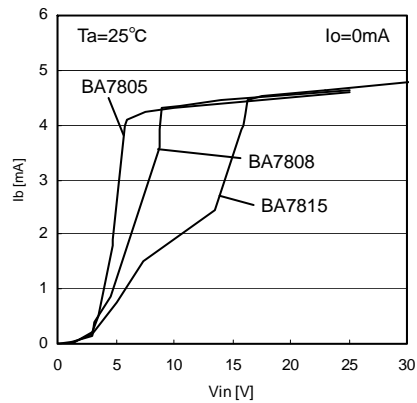

Fig.16 Vin - Ib

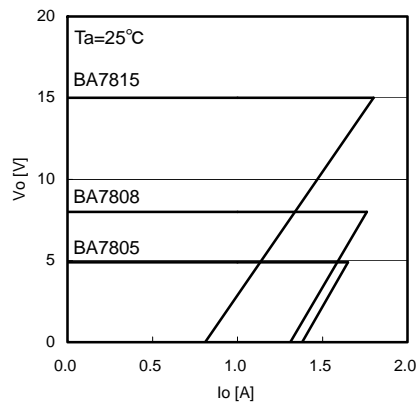

Fig.17 Load Regulation

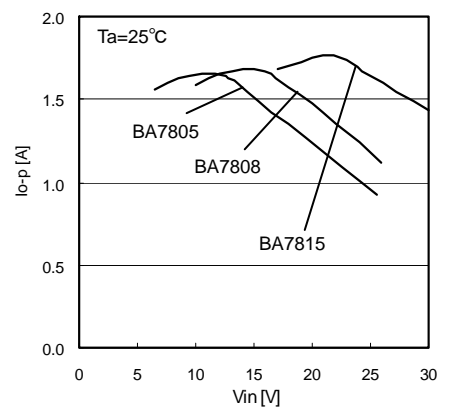

Fig.18 Peak Output Current

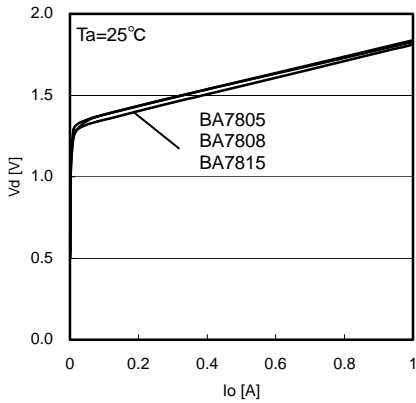

Fig.19 Dropout Voltage

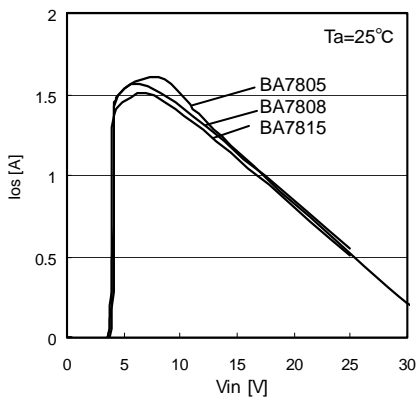

Fig.20 Short - Circuit Output Current

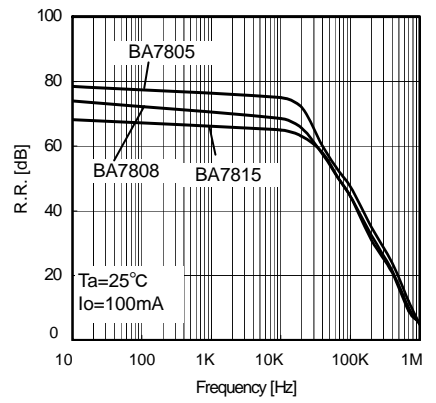

Fig.21 Ripple Rejection Ratio

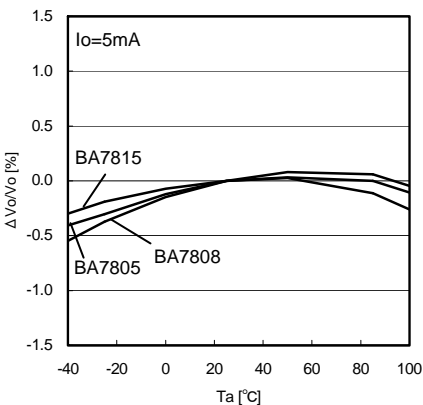

Fig.22 Ta - Vo

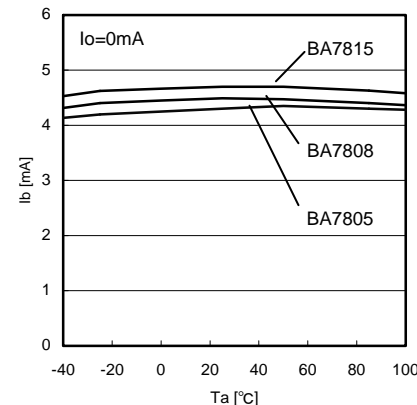

Fig.23 Ta - Ib

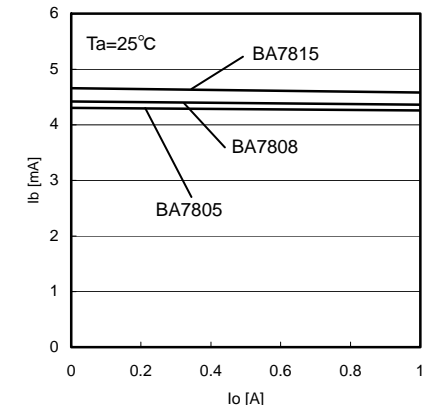
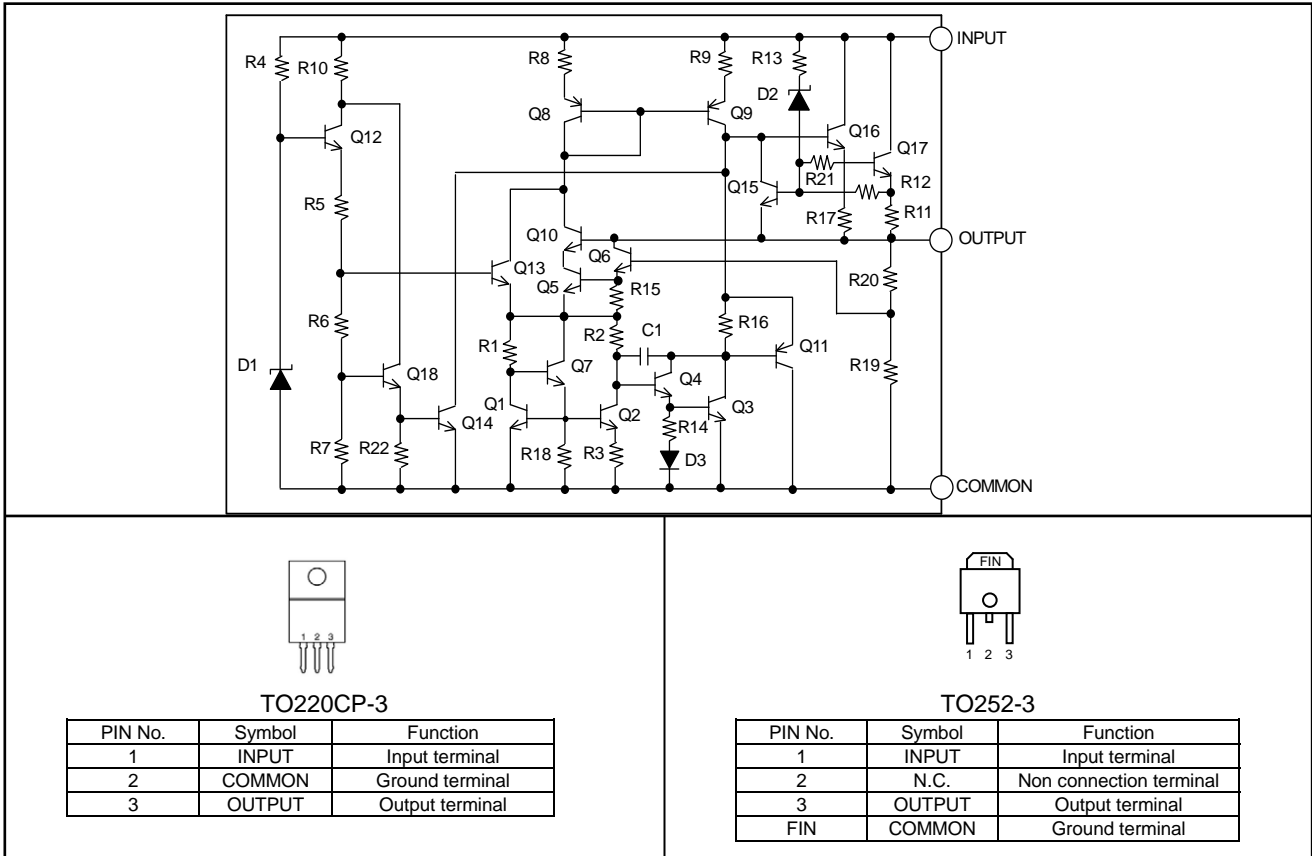

Fig.24 Io - Ib

●Internal Circuit Structural Diagram



●Protection Circuit

(1)Over-current protection circuit

When the maximum rating current or more is rushed, it controls the current ability and protects the IC from destruction.

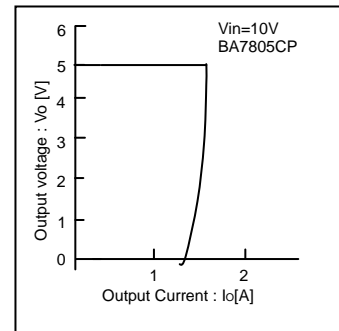

(2) Thermal shutdown circuit

When the chip temperature of IC exceeds the setting temperature, the IC goes OFF, and it controls the IC not to be destroyed by the heat generation. It can be restored by being lowered the chip temperature of IC below the setting temperature.

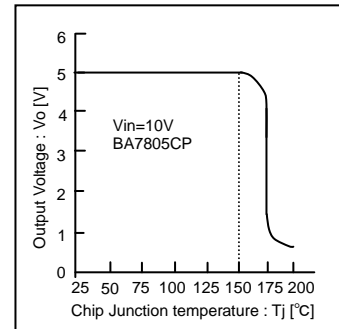

(3) Safety operation area control circuit

It controls the output current in inverse proportion ratio to voltage difference (input-output). When voltage difference becomes bigger, the IC will be destroyed in rush current. It protects the IC by controlling the current ability according to the voltage level.

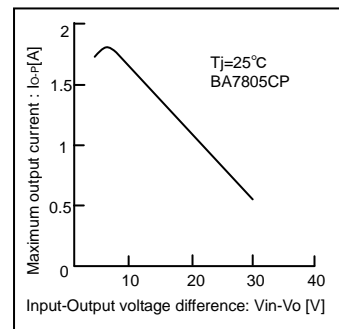

● Thermal design

Refer to the following thermal derating curves (Fig. 25, 26), when using in the status of Ta=25°C or more. The characteristic of IC is greatly related to the operating temperature. When it is used in over maximum junction temperature, the elements inside IC might become weaker and be destroyed. It is recommended to take into consideration thermal of IC. Note that the temperatures are in the allowed temperature limits and operated within Pd.

It is necessary to operate it at junction temperature Tjmax or less to prevent IC from the thermal destruction.

Please operate IC within permissible loss Pd because the junction temperature Tj might become considerably a high temperature even if ambient temperature Ta is normal temperature (25°C).

Power consumption Pc(W) may be expressed by the equation shown below:

$$P_c = (V_{in} - V_o) \times I_o + V_{in} \times I_b$$

permissible loss $P_d \geq P_c$

$$I_o \leq \frac{P_d - V_{in} \times I_b}{V_{in} - V_o}$$

Vin : Input Voltage
 Vo : Output Voltage
 Io : Output Current
 Ib : Bias current

Maximum Output current IoMAX can be calculated in thermal design.

• Calculation example

Ex.1) Ta=85°C, Vin =7.5V, Vo=5.0V

$$I_o \leq \frac{1.04 - 7.5 \times 4.5m}{7.5 - 5.0}$$

$$I_o \leq 400mA$$

Using TO220CP-3 alone
 θja=62.5°C/W → 16mW/°C
 Pd=1.04W at 85°C

Be sure to use this IC within a power dissipation at the range of operating temperature.

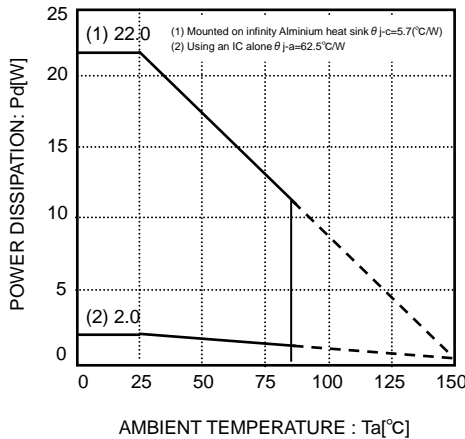

Fig.25 Thermal derating curve (TO220CP-3)

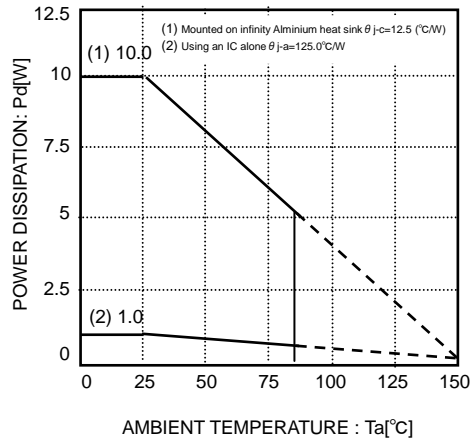

Fig.26 Thermal derating curve (TO252-3)

● Terminal Setting and Cautions

• INPUT

It is recommended that a capacitor (about 0.33uF) be inserted between INPUT and COMMON. The value of capacitor is designed suitable for the actual application.

• OUTPUT

It is recommended that a capacitor (about 0.1uF) be inserted between OUTPUT and COMMON. A tantalum capacitor can also be used for this pin because insufficient capacitors may cause oscillation by a temperature change.

• COMMON

Keep the no voltage drop between Ground level of set board and IC. When there is the voltage difference, setting voltage becomes inaccuracy and unstable. It is recommended to connect by wide, short pattern, and lower the impedance.

●Notes for use

(1) Absolute Maximum Ratings

While utmost care is taken to quality control of this product, any application that may exceed some of the absolute maximum ratings including the voltage applied and the operating temperature range may result in breakage. If broken, short-mode or open-mode may not be identified. So if it is expected to encounter with special mode that may exceed the absolute maximum ratings, it is requested to take necessary safety measures physically including insertion of fuses.

(2) Ground voltage

Make setting of the potential of the GND terminal so that it will be maintained at the minimum in any operating state. Furthermore, check to be sure no terminals are at a potential lower than the GND voltage including an actual electric transient.

(3) Thermal design

When you do the kind of use which exceeds Pd, It may be happened to deteriorating IC original quality such as decrease of electric current ability with chip temperature rise. Do not exceed the power dissipation (Pd) of the package specification rating under actual operation, and please design enough temperature margins.

(4) Short-circuiting between terminals, and mismounting

When mounting to pc board, care must be taken to avoid mistake in its orientation and alignment. Failure to do so may result in IC breakdown. Short-circuiting due to foreign matters entered between output terminals, or between output and power supply or GND may also cause breakdown.

(5) Operation in Strong electromagnetic field

Be noted that using the IC in the strong electromagnetic radiation can cause operation failures.

(6) Inspection with the IC set to a pc board

If a capacitor must be connected to the pin of lower impedance during inspection with the IC set to a pc board, the capacitor must be discharged after each process to avoid stress to the IC. For electrostatic protection, provide proper grounding to assembling processes with special care taken in handling and storage. When connecting to jigs in the inspection process, be sure to turn OFF the power supply before it is connected and removed.

(7) Input to IC terminals

This is a monolithic IC with P⁺ isolation between P-substrate and each element as illustrated below. This P-layer and the N-layer of each element form a P-N junction, and various parasitic element are formed.

If a resistor is joined to a transistor terminal as shown in Fig 28.

- OP-N junction works as a parasitic diode if the following relationship is satisfied;
 - GND>Terminal A (at resistor side), or GND>Terminal B (at transistor side); and
 - Oif GND>Terminal B (at NPN transistor side),

a parasitic NPN transistor is activated by N-layer of other element adjacent to the above-mentioned parasitic diode.

The structure of the IC inevitably forms parasitic elements, the activation of which may cause interference among circuits, and/or malfunctions contributing to breakdown. It is therefore requested to take care not to use the device in such manner that the voltage lower than GND (at P-substrate) may be applied to the input terminal, which may result in activation of parasitic elements.

(8) Ground wiring pattern

If small-signal GND and large-current GND are provided, It will be recommended to separate the large-current GND pattern from the small-signal GND pattern and establish a single ground at the reference point of the set PCB so that resistance to the wiring pattern and voltage fluctuations due to a large current will cause no fluctuations in voltages of the small-signal GND. Pay attention not to cause fluctuations in the GND wiring pattern of external parts as well.

(9) Thermal shutdown circuit

A temperature control circuit is built in the IC to prevent the damage due to overheat. Therefore, the output is turned off when the thermal circuit works and is turned on when the temperature goes down to the specified level.

But, built-in the IC a temperature control circuit to protect itself, and avoid the design used the thermal protection.

(10) Over current protection circuit

The over-current protection circuits are built in at output, according to their respective current outputs and prevent the IC from being damaged when the load is short-circuited or over-current. But, these protection circuits are effective for preventing destruction by unexpected accident. When it's in continuous protection circuit moving period don't use please. And for ability, because this chip has minus characteristic, be careful for heat plan.

(11) There is a possibility to damage an internal circuit or the element when Vin and the voltage of each terminal reverse in the application. For instance, Vin is short-circuited to GND etc. with the charge charged to an external capacitor. Please use the capacitor of the output terminal with 1000μF or less. Moreover, the Vin series is recommended to insert the diode of the by-pass the diode of the backflow prevention or between each terminal and Vin.

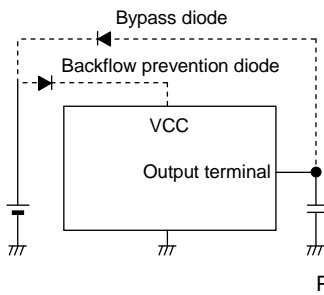

Fig.27 Bypass Diode

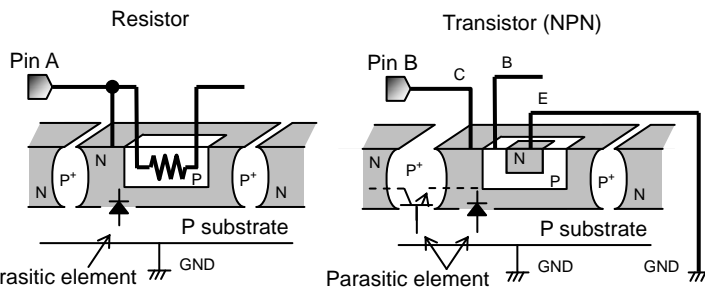
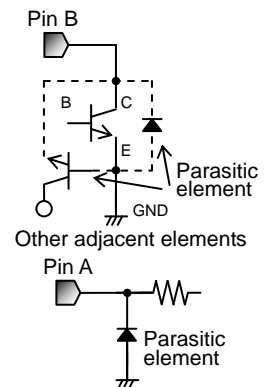
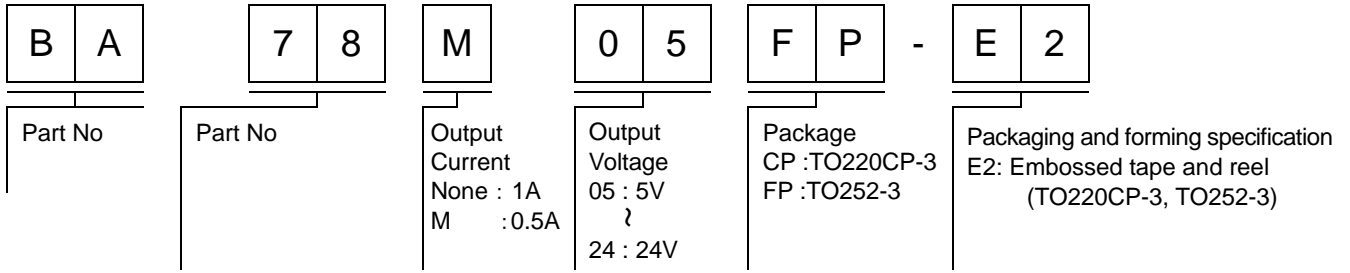

Fig.28 Simplified structure of monoristic IC



●Ordering part number



TO220CP-3

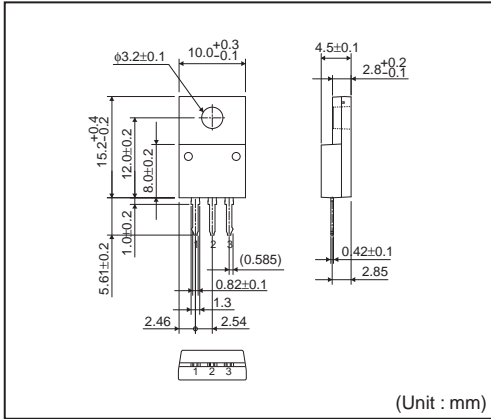

<Tape and Reel information>

| | |
|-------------------|---|
| Tape | Embossed carrier tape |
| Quantity | 500pcs |
| Direction of feed | E2 (The direction is the 1pin of product is at the lower left when you hold reel on the left hand and you pull out the tape on the right hand) |

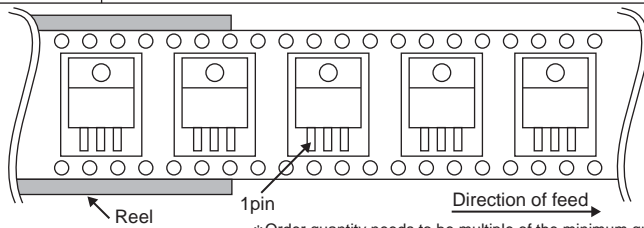

*Order quantity needs to be multiple of the minimum quantity.

TO252-3

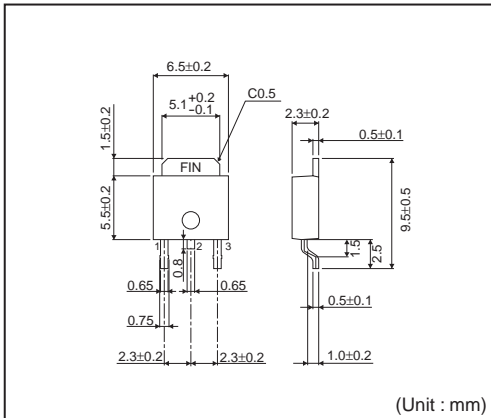

<Tape and Reel information>

| | |
|-------------------|---|
| Tape | Embossed carrier tape |
| Quantity | 2000pcs |
| Direction of feed | E2 (The direction is the 1pin of product is at the lower left when you hold reel on the left hand and you pull out the tape on the right hand) |

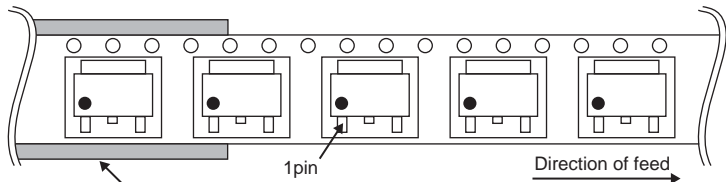

*Order quantity needs to be multiple of the minimum quantity.

Notice

Precaution on using ROHM Products

- Our Products are designed and manufactured for application in ordinary electronic equipments (such as AV equipment, OA equipment, telecommunication equipment, home electronic appliances, amusement equipment, etc.). If you intend to use our Products in devices requiring extremely high reliability (such as medical equipment ^(Note 1), transport equipment, traffic equipment, aircraft/spacecraft, nuclear power controllers, fuel controllers, car equipment including car accessories, safety devices, etc.) and whose malfunction or failure may cause loss of human life, bodily injury or serious damage to property ("Specific Applications"), please consult with the ROHM sales representative in advance. Unless otherwise agreed in writing by ROHM in advance, ROHM shall not be in any way responsible or liable for any damages, expenses or losses incurred by you or third parties arising from the use of any ROHM's Products for Specific Applications.

(Note1) Medical Equipment Classification of the Specific Applications

| JAPAN | USA | EU | CHINA |
|-----------|-----------|------------|-----------|
| CLASS III | CLASS III | CLASS II b | CLASS III |
| CLASS IV | | CLASS III | |

- ROHM designs and manufactures its Products subject to strict quality control system. However, semiconductor products can fail or malfunction at a certain rate. Please be sure to implement, at your own responsibilities, adequate safety measures including but not limited to fail-safe design against the physical injury, damage to any property, which a failure or malfunction of our Products may cause. The following are examples of safety measures:
 - Installation of protection circuits or other protective devices to improve system safety
 - Installation of redundant circuits to reduce the impact of single or multiple circuit failure
- Our Products are designed and manufactured for use under standard conditions and not under any special or extraordinary environments or conditions, as exemplified below. Accordingly, ROHM shall not be in any way responsible or liable for any damages, expenses or losses arising from the use of any ROHM's Products under any special or extraordinary environments or conditions. If you intend to use our Products under any special or extraordinary environments or conditions (as exemplified below), your independent verification and confirmation of product performance, reliability, etc. prior to use, must be necessary:
 - Use of our Products in any types of liquid, including water, oils, chemicals, and organic solvents
 - Use of our Products outdoors or in places where the Products are exposed to direct sunlight or dust
 - Use of our Products in places where the Products are exposed to sea wind or corrosive gases, including Cl₂, H₂S, NH₃, SO₂, and NO₂
 - Use of our Products in places where the Products are exposed to static electricity or electromagnetic waves
 - Use of our Products in proximity to heat-producing components, plastic cords, or other flammable items
 - Sealing or coating our Products with resin or other coating materials
 - Use of our Products without cleaning residue of flux (even if you use no-clean type fluxes, cleaning residue of flux is recommended); or Washing our Products by using water or water-soluble cleaning agents for cleaning residue after soldering
 - Use of the Products in places subject to dew condensation
- The Products are not subject to radiation-proof design.
- Please verify and confirm characteristics of the final or mounted products in using the Products.
- In particular, if a transient load (a large amount of load applied in a short period of time, such as pulse. is applied, confirmation of performance characteristics after on-board mounting is strongly recommended. Avoid applying power exceeding normal rated power; exceeding the power rating under steady-state loading condition may negatively affect product performance and reliability.
- De-rate Power Dissipation (Pd) depending on Ambient temperature (Ta). When used in sealed area, confirm the actual ambient temperature.
- Confirm that operation temperature is within the specified range described in the product specification.
- ROHM shall not be in any way responsible or liable for failure induced under deviant condition from what is defined in this document.

Precaution for Mounting / Circuit board design

- When a highly active halogenous (chlorine, bromine, etc.) flux is used, the residue of flux may negatively affect product performance and reliability.
- In principle, the reflow soldering method must be used; if flow soldering method is preferred, please consult with the ROHM representative in advance.

For details, please refer to ROHM Mounting specification

Precautions Regarding Application Examples and External Circuits

1. If change is made to the constant of an external circuit, please allow a sufficient margin considering variations of the characteristics of the Products and external components, including transient characteristics, as well as static characteristics.
2. You agree that application notes, reference designs, and associated data and information contained in this document are presented only as guidance for Products use. Therefore, in case you use such information, you are solely responsible for it and you must exercise your own independent verification and judgment in the use of such information contained in this document. ROHM shall not be in any way responsible or liable for any damages, expenses or losses incurred by you or third parties arising from the use of such information.

Precaution for Electrostatic

This Product is electrostatic sensitive product, which may be damaged due to electrostatic discharge. Please take proper caution in your manufacturing process and storage so that voltage exceeding the Products maximum rating will not be applied to Products. Please take special care under dry condition (e.g. Grounding of human body / equipment / solder iron, isolation from charged objects, setting of Ionizer, friction prevention and temperature / humidity control).

Precaution for Storage / Transportation

1. Product performance and soldered connections may deteriorate if the Products are stored in the places where:
 - [a] the Products are exposed to sea winds or corrosive gases, including Cl₂, H₂S, NH₃, SO₂, and NO₂
 - [b] the temperature or humidity exceeds those recommended by ROHM
 - [c] the Products are exposed to direct sunshine or condensation
 - [d] the Products are exposed to high Electrostatic
2. Even under ROHM recommended storage condition, solderability of products out of recommended storage time period may be degraded. It is strongly recommended to confirm solderability before using Products of which storage time is exceeding the recommended storage time period.
3. Store / transport cartons in the correct direction, which is indicated on a carton with a symbol. Otherwise bent leads may occur due to excessive stress applied when dropping of a carton.
4. Use Products within the specified time after opening a humidity barrier bag. Baking is required before using Products of which storage time is exceeding the recommended storage time period.

Precaution for Product Label

QR code printed on ROHM Products label is for ROHM's internal use only.

Precaution for Disposition

When disposing Products please dispose them properly using an authorized industry waste company.

Precaution for Foreign Exchange and Foreign Trade act

Since our Products might fall under controlled goods prescribed by the applicable foreign exchange and foreign trade act, please consult with ROHM representative in case of export.

Precaution Regarding Intellectual Property Rights

1. All information and data including but not limited to application example contained in this document is for reference only. ROHM does not warrant that foregoing information or data will not infringe any intellectual property rights or any other rights of any third party regarding such information or data. ROHM shall not be in any way responsible or liable for infringement of any intellectual property rights or other damages arising from use of such information or data.:
2. No license, expressly or implied, is granted hereby under any intellectual property rights or other rights of ROHM or any third parties with respect to the information contained in this document.

Other Precaution

1. This document may not be reprinted or reproduced, in whole or in part, without prior written consent of ROHM.
2. The Products may not be disassembled, converted, modified, reproduced or otherwise changed without prior written consent of ROHM.
3. In no event shall you use in any way whatsoever the Products and the related technical information contained in the Products or this document for any military purposes, including but not limited to, the development of mass-destruction weapons.
4. The proper names of companies or products described in this document are trademarks or registered trademarks of ROHM, its affiliated companies or third parties.

General Precaution

1. Before you use our Products, you are requested to carefully read this document and fully understand its contents. ROHM shall not be in any way responsible or liable for failure, malfunction or accident arising from the use of any ROHM's Products against warning, caution or note contained in this document.
2. All information contained in this document is current as of the issuing date and subject to change without any prior notice. Before purchasing or using ROHM's Products, please confirm the latest information with a ROHM sales representative.
3. The information contained in this document is provided on an "as is" basis and ROHM does not warrant that all information contained in this document is accurate and/or error-free. ROHM shall not be in any way responsible or liable for any damages, expenses or losses incurred by you or third parties resulting from inaccuracy or errors of or concerning such information.

X-ON Electronics

Largest Supplier of Electrical and Electronic Components

Click to view similar products for [Linear Voltage Regulators](#) category:

Click to view products by [ROHM](#) manufacturer:

Other Similar products are found below :

[LV56831P-E](#) [LV5684PVD-XH](#) [MAX202ECWE-LF](#) [MCDTSA6-2R](#) [L4953G](#) [L7815ACV-DG](#) [PQ3DZ53U](#) [LV56801P-E](#)
[TCR3DF13,LM\(CT](#) [TCR3DF39,LM\(CT](#) [TLE42794G](#) [L78L05CZ/1SX](#) [L78LR05DL-MA-E](#) [L78MR05-E](#) [033150D](#) [033151B](#) [090756R](#)
[636416C](#) [NCV78M15BDTG](#) [702482B](#) [714954EB](#) [TLE42794GM](#) [TLE42994GM](#) [ZMR500QFTA](#) [BA033LBSG2-TR](#)
[NCV78M05ABDTRKG](#) [NCV78M08BDTRKG](#) [NCP7808TG](#) [NCV571SN12T1G](#) [LV5680P-E](#) [CAJ24C256YI-GT3](#) [L78M15CV-DG](#) [L9474N](#)
[TLS202B1MBV33HTSA1](#) [L79M05T-E](#) [NCP571SN09T1G](#) [MAX15006AASA/V+](#) [MIC5283-5.0YML-T5](#) [L4969URTR-E](#) [L78LR05D-MA-E](#)
[NCV7808BDTRKG](#) [L9466N](#) [NCP7805ETG](#) [SC7812CTG](#) [NCV7809BTG](#) [NCV571SN09T1G](#) [NCV317MBTG](#) [MC78M15CDTT5G](#)
[MC78M12CDTT5G](#) [L9468N](#)