

# 1 Channel Compact High Side Switch ICs

## 2.0A Current Limit High Side Switch ICs

### BD82023FVJ

#### Description

BD82023FVJ is a Single Channel High Side Switch IC employing N-channel power MOSFET with low on resistance and low supply current for the power supply line of universal serial bus (USB).

This IC has a built-in over current detection circuit, thermal shutdown circuit, under voltage lockout and soft start circuits.

#### Features

- Over-Current Protection : 2.0A
- Control Input Logic : Active-Low
- Output Discharge Function
- Reverse Current Protection when Power Switch Off
- Thermal Shutdown
- Open-Drain Fault Flag Output
- Under-Voltage Lockout
- OCP Fast Response
- Soft-Start Circuit
- ESD Protection
- UL : File No. E243261
- IEC 60950-1 CB\_scheme: File No.US-18106-UL

#### Key Specifications

- |                                |              |
|--------------------------------|--------------|
| ■ Input Voltage Range:         | 2.8V to 5.5V |
| ■ ON Resistance: (VIN=5V)      | 90mΩ(Typ)    |
| ■ Over Current Threshold:      | 2.0A         |
| ■ Standby Current:             | 0.01μA (Typ) |
| ■ Operating Temperature Range: | -40 to +85   |

#### Package

TSSOP-B8J

W(Typ) D(Typ) H(Max)  
3.00mm x 4.90mm x 1.10mm



#### Applications

USB hub in consumer appliances, PC, PC peripheral equipment, and so forth

#### Typical Application Circuit

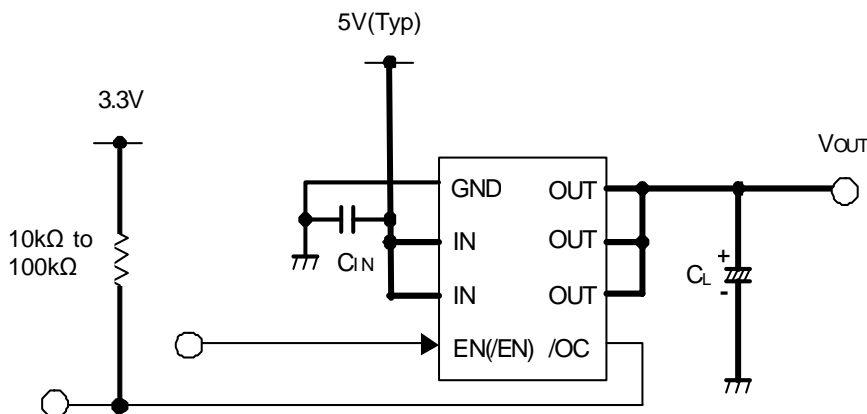

Figure 1. Typical Application Circuit

Block Diagram



Figure 2. Block Diagram

Pin Configuration

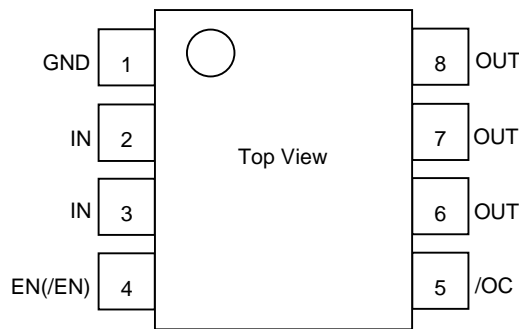

Figure 3. Pin Configuration (TOP VIEW)

Pin Descriptions

Pin No.	Symbol	I/O	Function
1	GND	-	Ground
2, 3	IN	I	Power supply input Input terminal to the power switch and power supply input terminal of the internal circuit Short these pins externally
4	EN, /EN	I	Enable input Active low power on switch High level input > 2.0V, Low level input < 0.8V
5	/OC	O	Error flag output Low when over-current or thermal shutdown is activated Open drain output
6, 7, 8	OUT	O	Power switch output Short these pins externally

**Absolute Maximum Ratings**( $T_a=25$  )

Parameter	Symbol	Rating	Unit
IN Supply Voltage	$V_{IN}$	-0.3 to +6.0	V
/EN Input Voltage	$V_{/EN}$	-0.3 to +6.0	V
/OC Voltage	$V_{/OC}$	-0.3 to +6.0	V
/OC Sink Current	$I_{/OC}$	5	mA
OUT Voltage	$V_{OUT}$	-0.3 to +6.0	V
Storage Temperature	$T_{stg}$	-55 to +150	
Power Dissipation	$P_d$	587.5 <sup>(1)</sup>	mW

(1) Mounted on 70mm x 70mm x 1.6mm glass epoxy board. Reduce 4.7mW per 1 above 25

**Recommended Operating Ratings**

Parameter	Symbol	Rating			Unit
		Min	Typ	Max	
IN Operating Voltage	$V_{IN}$	2.8	-	5.5	V
Operating Temperature	$T_{opr}$	-40	-	+85	

**Electrical Characteristics** ( $V_{IN}=5V$ ,  $T_a=25$  , unless otherwise specified.)DC Characteristics

Parameter	Symbol	Limit			Unit	Condition
		Min	Typ	Max		
Operating Current	$I_{DD}$	-	95	135	$\mu A$	$V_{/EN}=0V$ , $V_{OUT}$ = open
Standby Current	$I_{STB}$	-	0.01	1	$\mu A$	$V_{/EN}=5V$ , $V_{OUT}$ = open
/EN Input Voltage	$V_{/ENH}$	2.0	-	-	V	High input
	$V_{/ENL}$	-	-	0.8	V	Low input
/EN Input Leakage	$I_{/EN}$	-1	0.01	+1	$\mu A$	$V_{/EN}=0V$ or 5V
On Resistance	$R_{ON}$	-	90	115	m $\Omega$	$I_{OUT}=1.0A$
Reverse Leak Current	$I_{REV}$	-	-	1	$\mu A$	$V_{OUT}=5.5V$ , $V_{IN}=0V$
Over-Current Threshold	$I_{TH}$	1.5	2.0	2.6	A	Current Load Slew rate 100A/s
Short Circuit Output Current	$I_{SC}$	1.1	1.4	1.9	A	$V_{OUT}=0V$ $C_L=100\mu F$ RMS
Output Discharge Resistance	$R_{DISC}$	-	75	150	$\Omega$	$I_{OUT}=1mA$ , $V_{/EN}=5V$
/OC Output Low Voltage	$V_{/OC}$	-	-	0.4	V	$I_{/OC}=1mA$
/OC Output Leak Current	$I_{L/OC}$	-	0.01	1	$\mu A$	$V_{/OC}=5V$
UVLO Threshold	$V_{TUVH}$	2.0	2.3	2.5	V	$V_{IN}$ increasing
	$V_{TUVL}$	1.9	2.2	2.4	V	$V_{IN}$ decreasing

AC Characteristics

Parameter	Symbol	Limit			Unit	Condition
		Min	Typ	Max		
Output Rise Time	$t_{ON1}$	-	0.4	10	ms	$R_L=10\Omega$
Output Turn-on Time	$t_{ON2}$	-	0.6	20	ms	
Output Fall Time	$t_{OFF1}$	-	2	20	$\mu s$	
Output Turn-off Time	$t_{OFF2}$	-	4	40	$\mu s$	
/OC Delay Time	$t_{/OC}$	5	12	20	ms	

Measurement Circuit

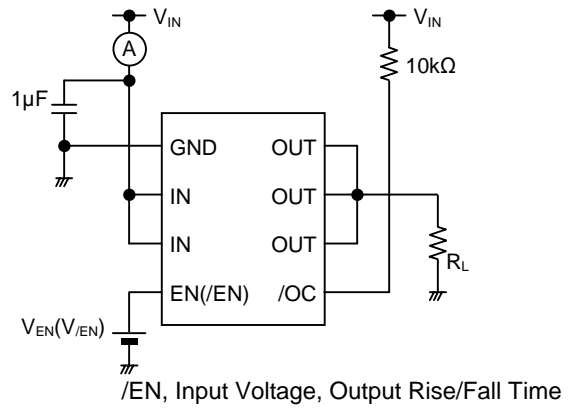
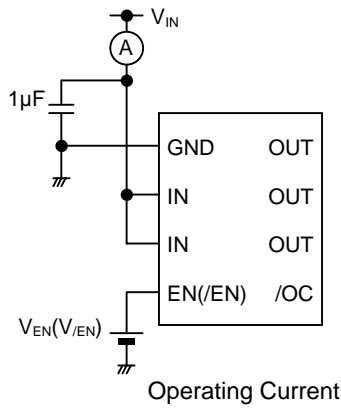

Figure 4. Measurement Circuit

Timing Diagram

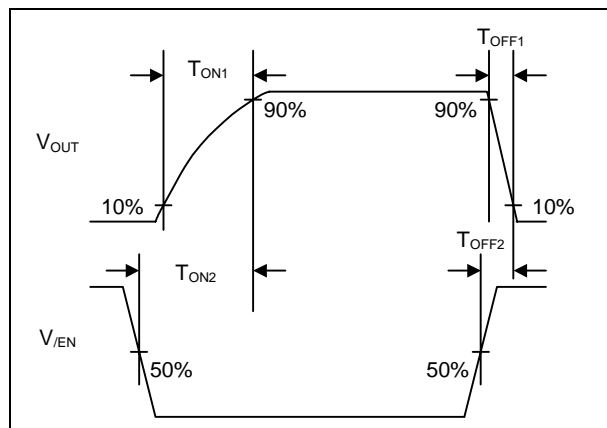

Figure 5. Output Rise/Fall Time

Typical Performance Curves

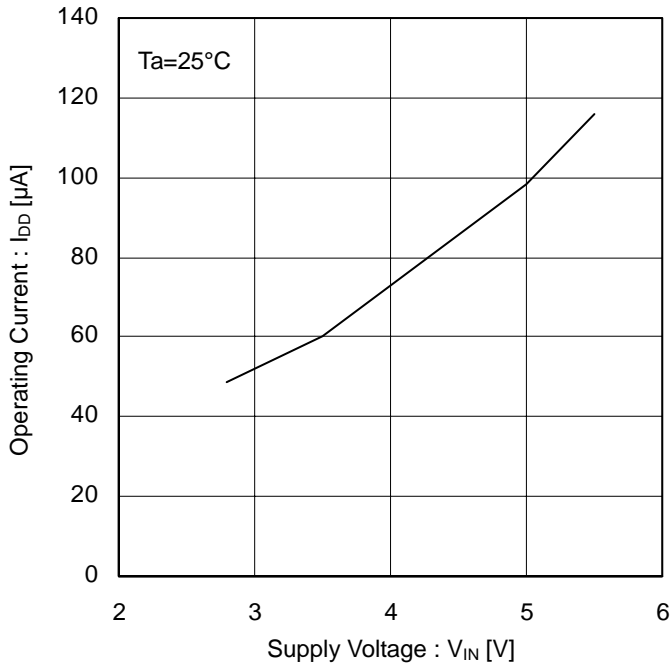

Figure 6. Operating Current EN Enable

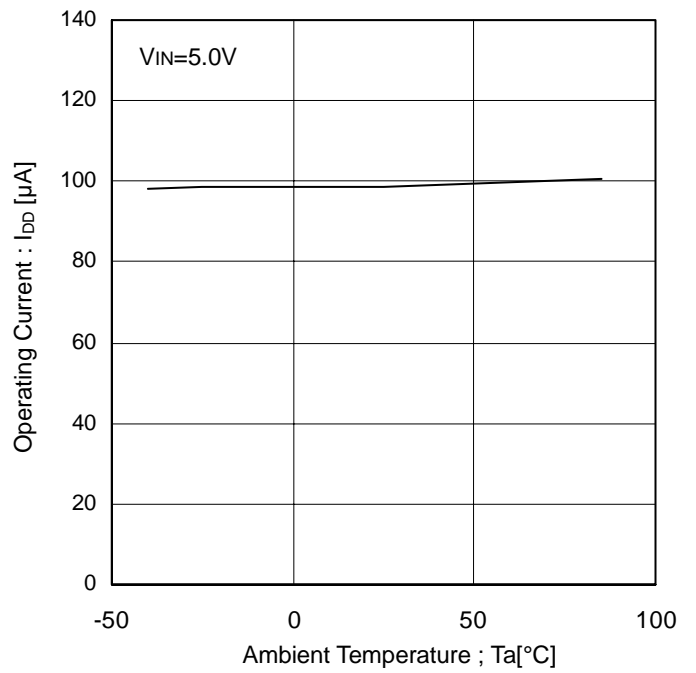

Figure 7. Operating Current EN Enable

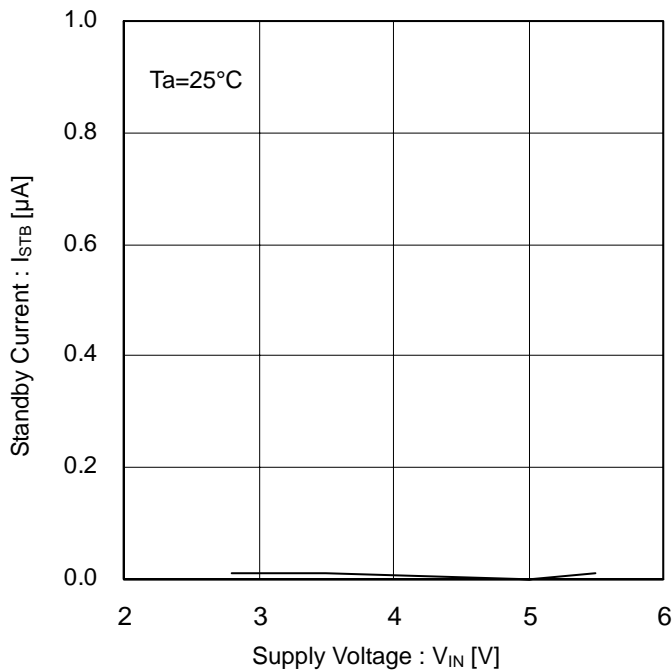

Figure 8. Standby Current EN Disable

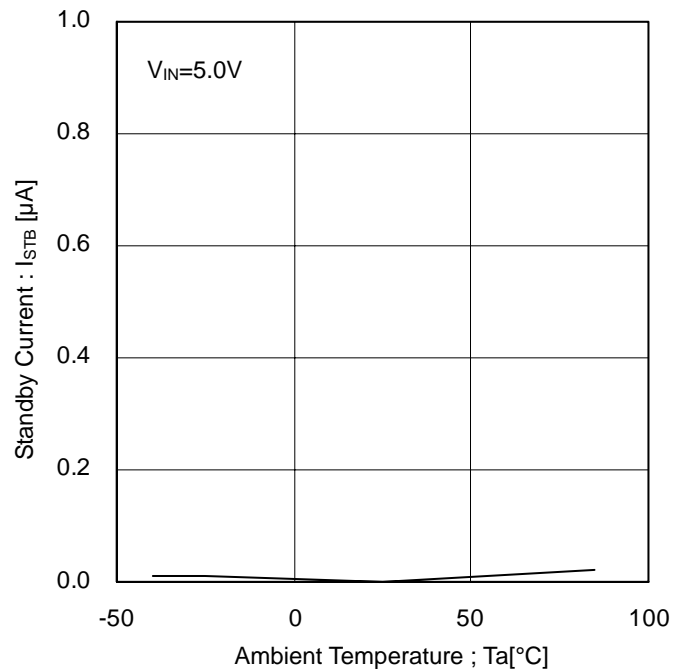
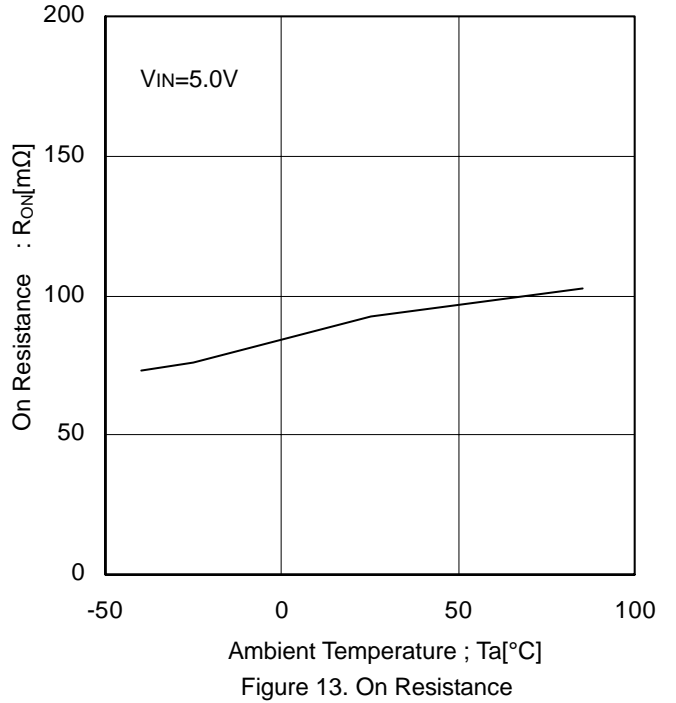
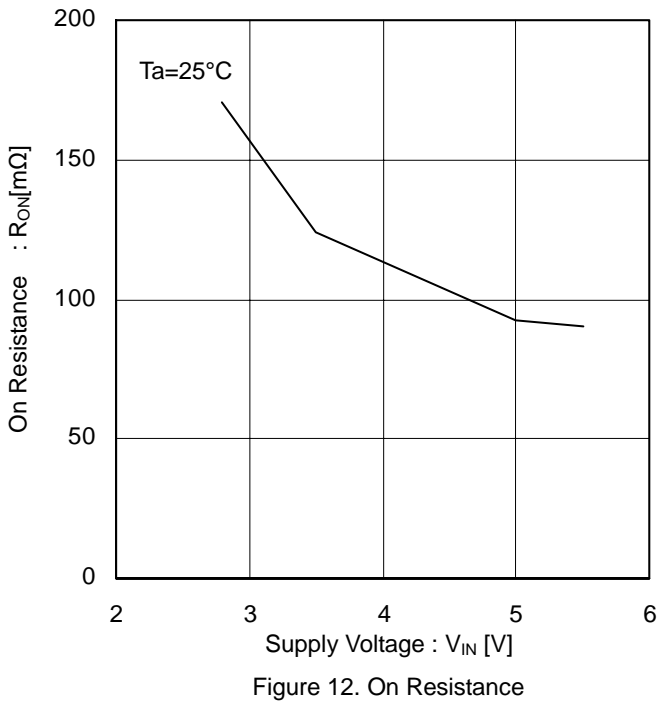
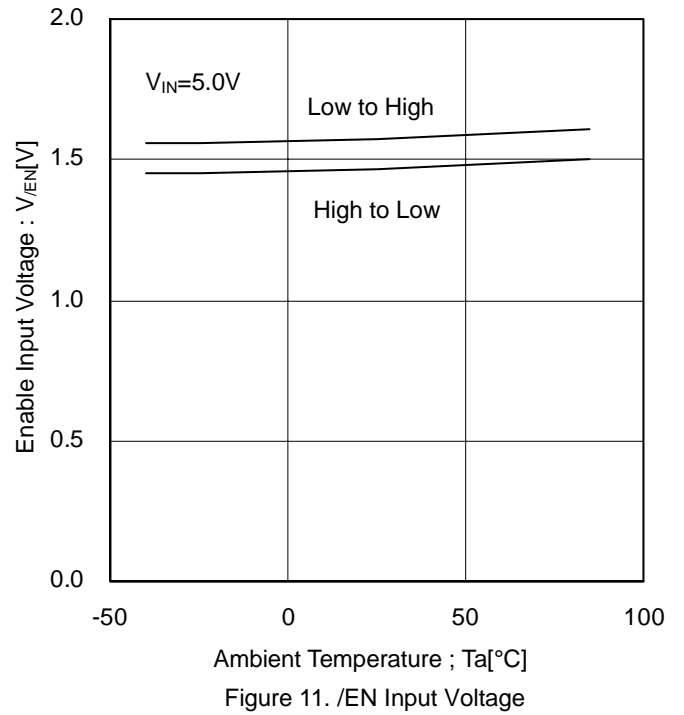
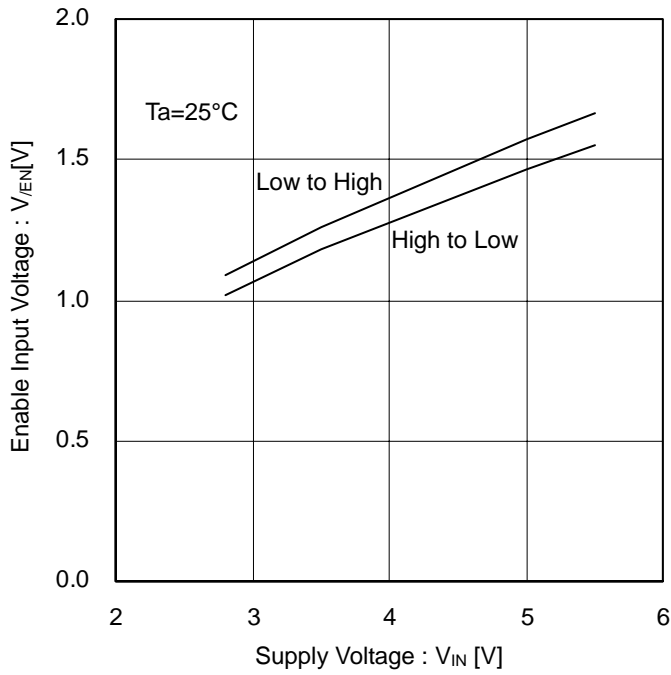

Figure 9. Standby Current EN Disable

Typical Performance Curves - continued



Typical Performance Curves - continued

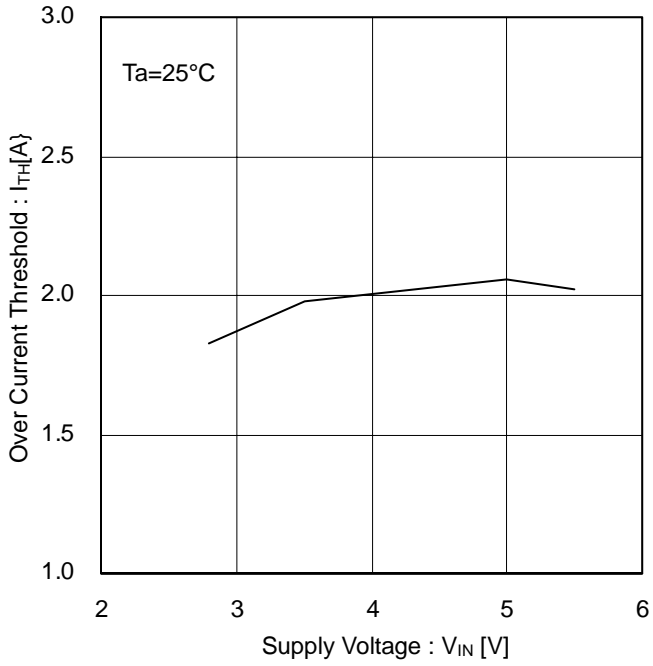

Figure 14. Over-Current Threshold

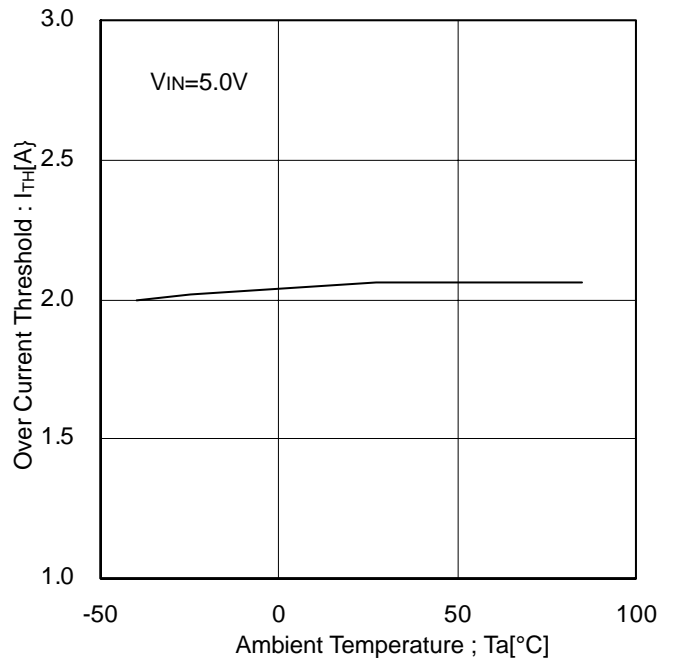

Figure 15. Over-Current Threshold

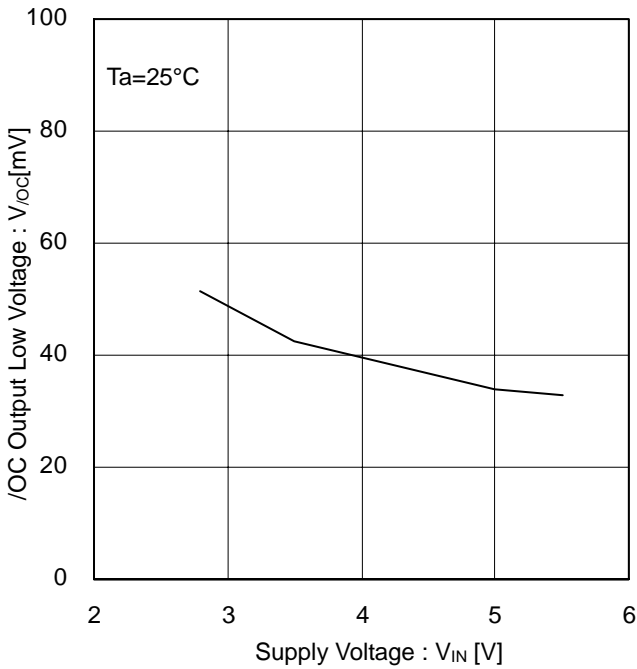

Figure 16. /OC Output Low Voltage

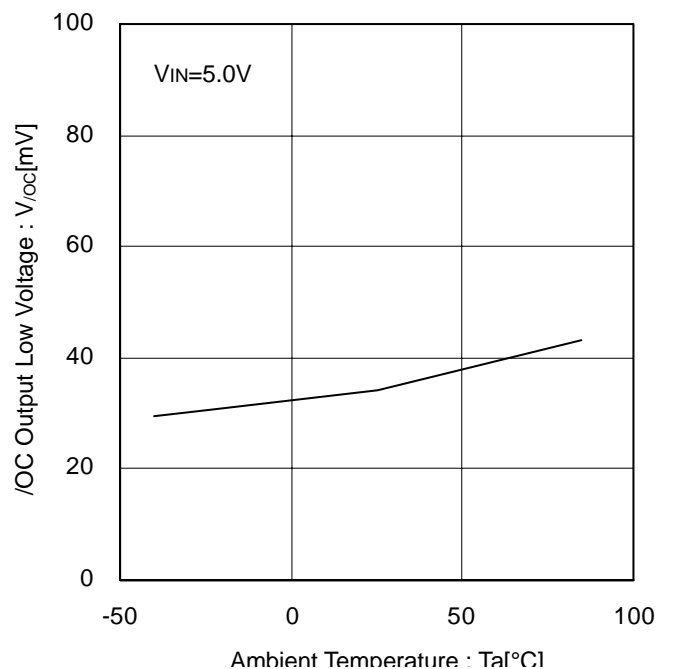

Figure 17. /OC Output Low Voltage

Typical Performance Curves - continued

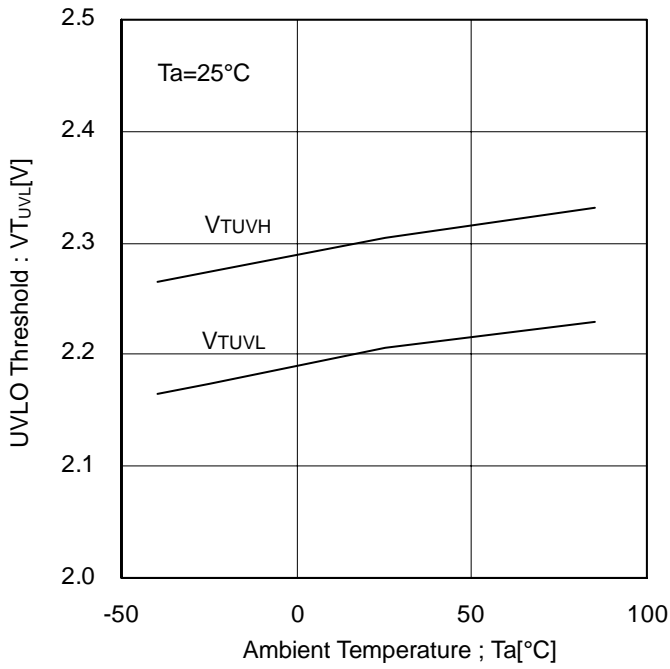

Figure 18. UVLO Threshold

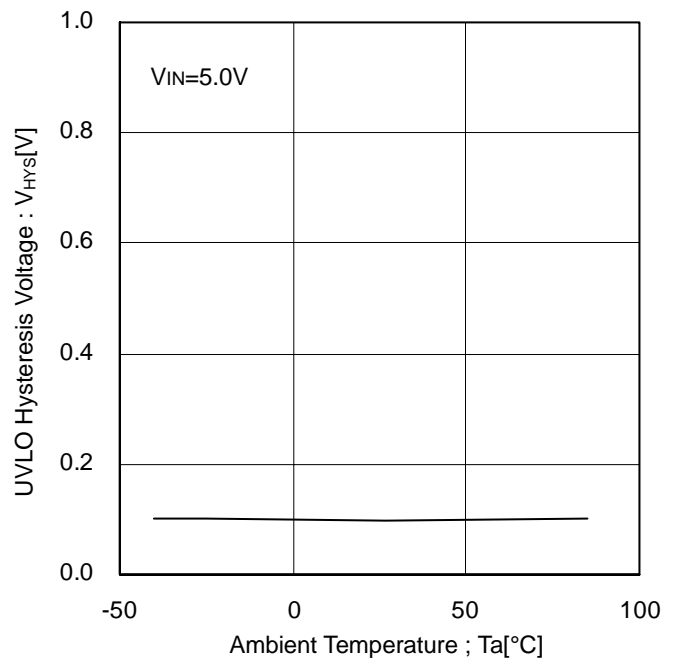

Figure 19. UVLO Hysteresis Voltage

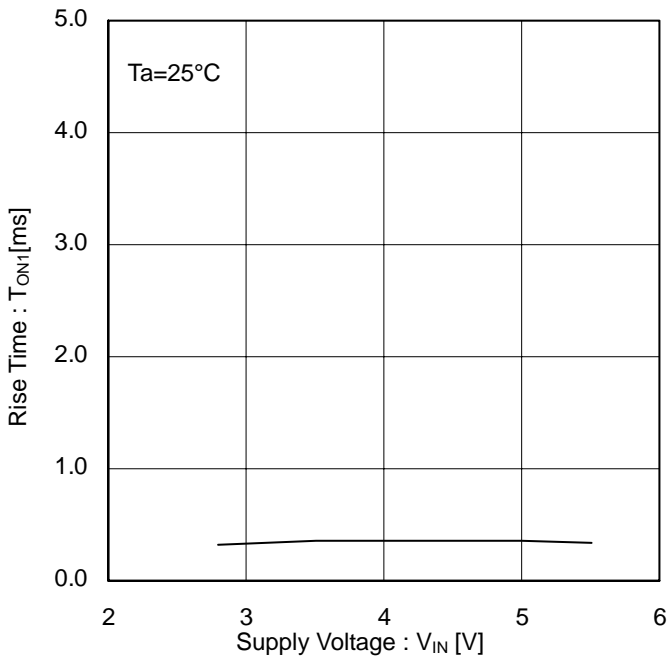

Figure 20. Output Rise Time

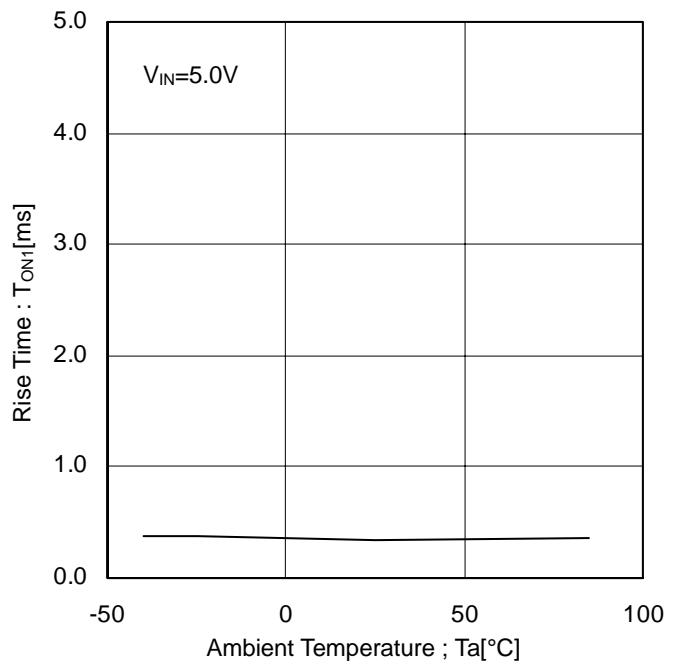

Figure 21. Output Rise Time



Typical Performance Curves - continued

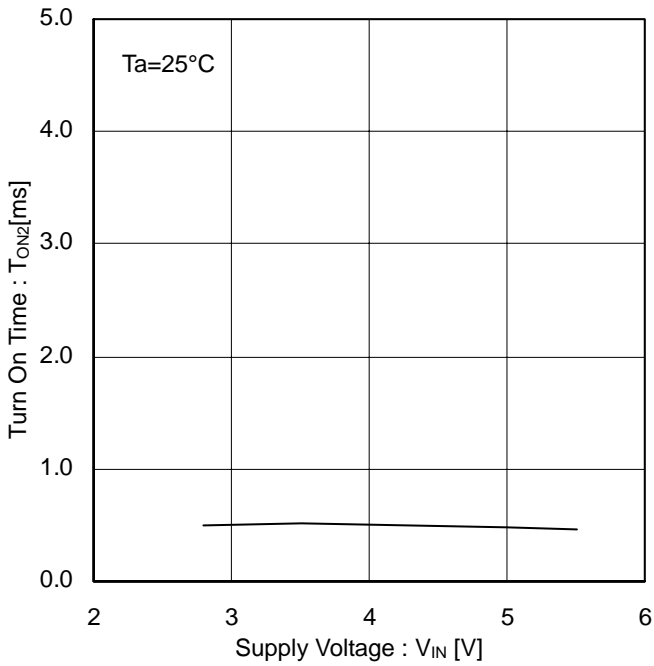

Figure 22. Output Turn-on Time

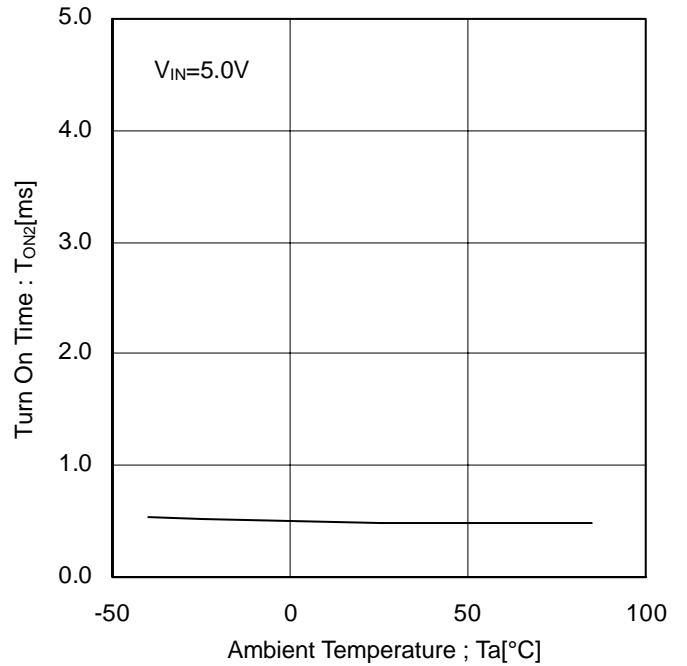

Figure 23. Output Turn-on Time

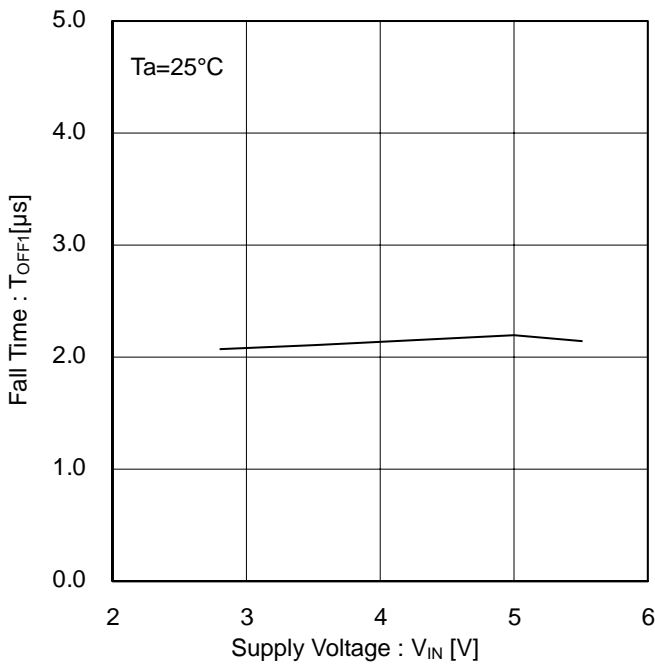

Figure 24. Output Fall Time

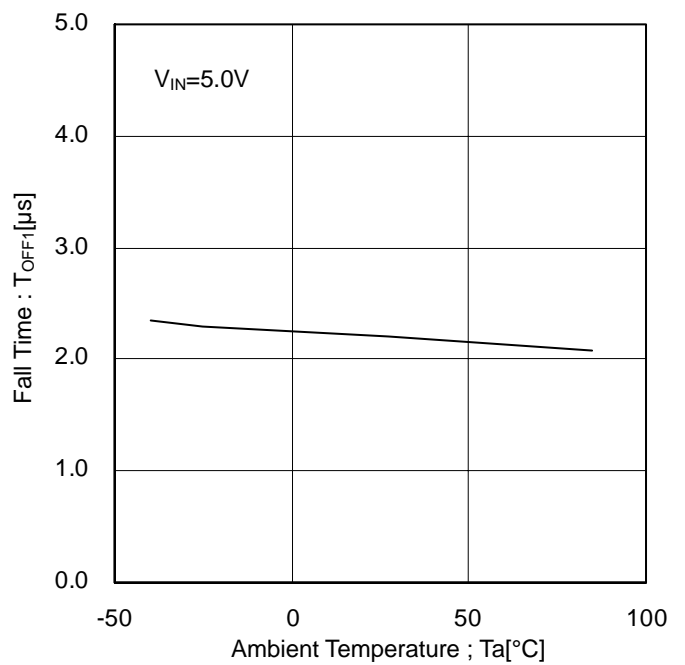

Figure 25. Output Fall Time

Typical Performance Curves - continued

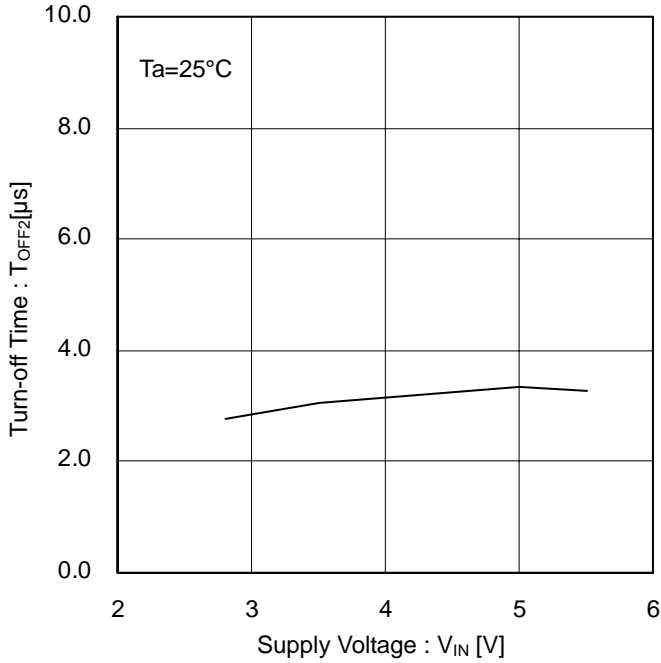

Figure 26. Output Turn-off Time

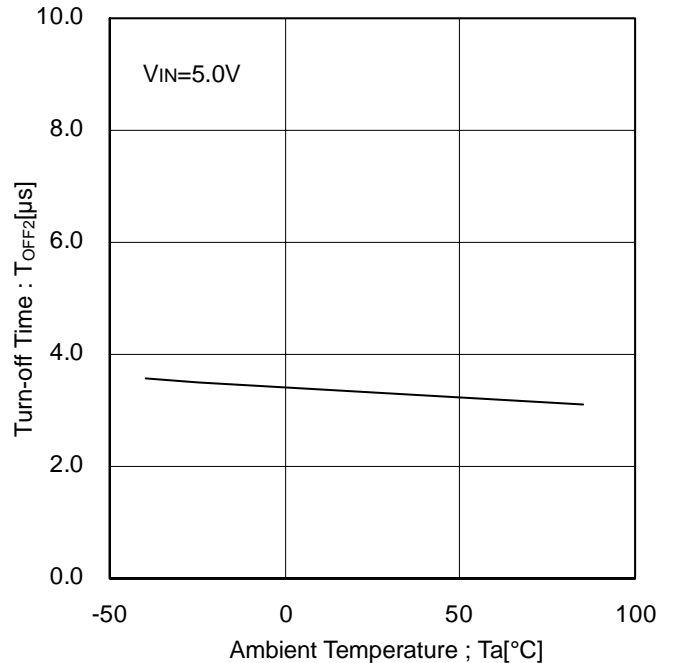

Figure 27. Output Turn-off Time

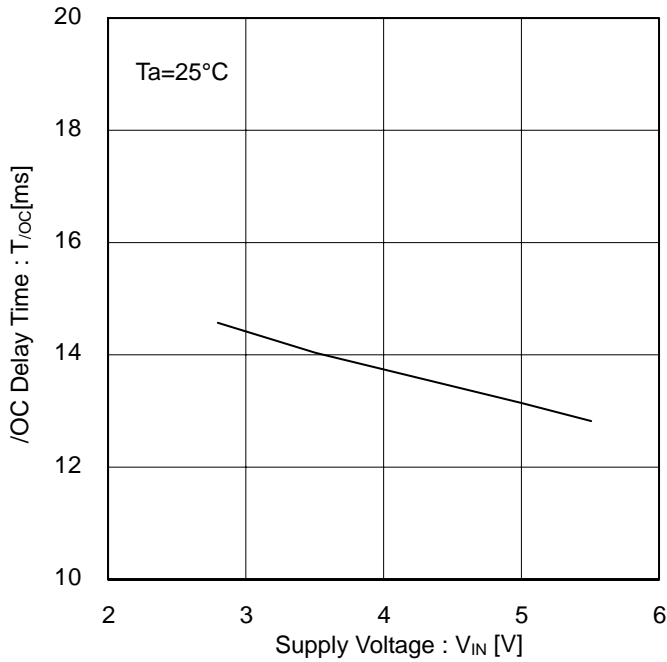

Figure 28. /OC Delay Time

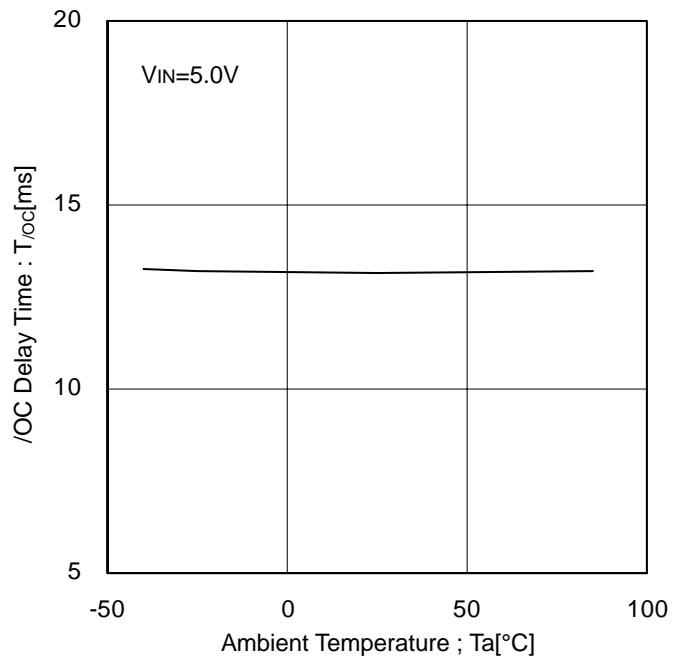

Figure 29. /OC Delay Time

Typical Performance Curves - continued

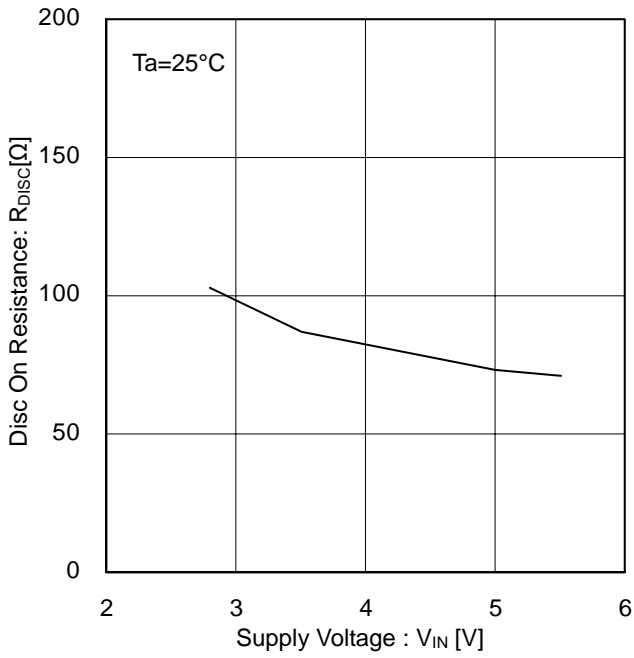

Figure 30. Discharge On Resistance

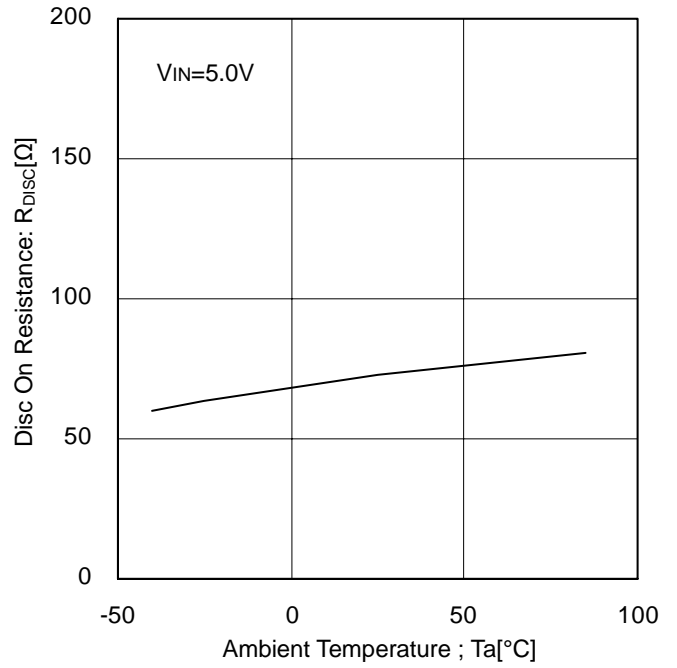

Figure 31. Discharge On Resistance

Typical Wave Forms (BD82023FVJ)

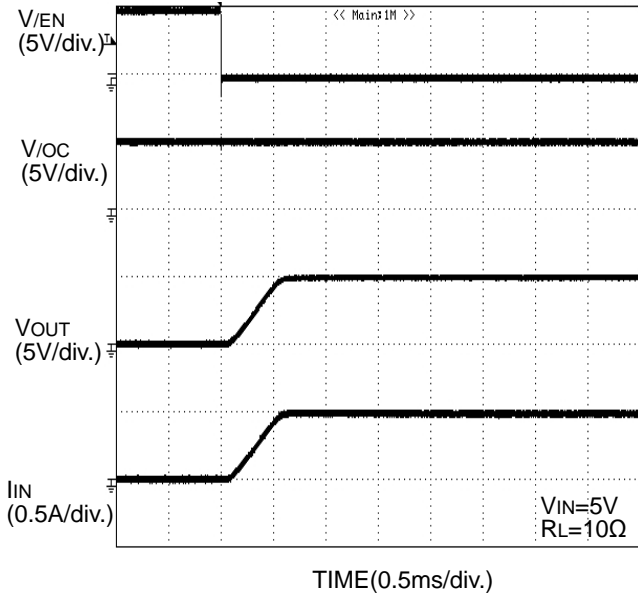

Figure 32. Output Rise Characteristic

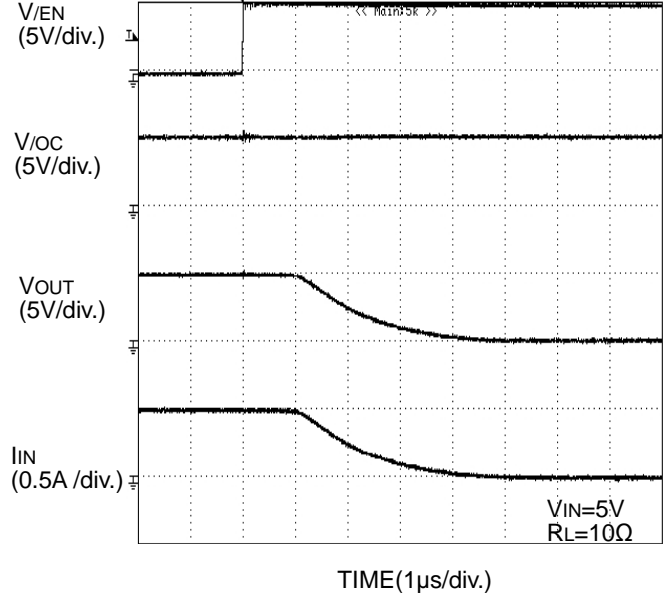

Figure 33. Output Fall Characteristic

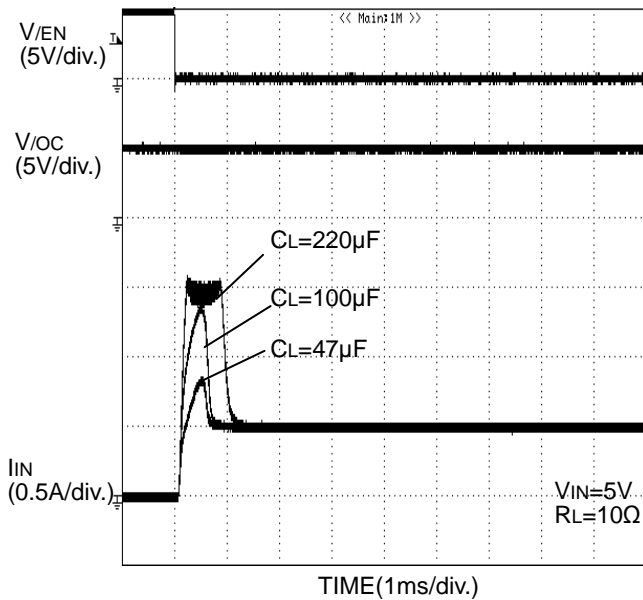

Figure 34. Inrush Current Response

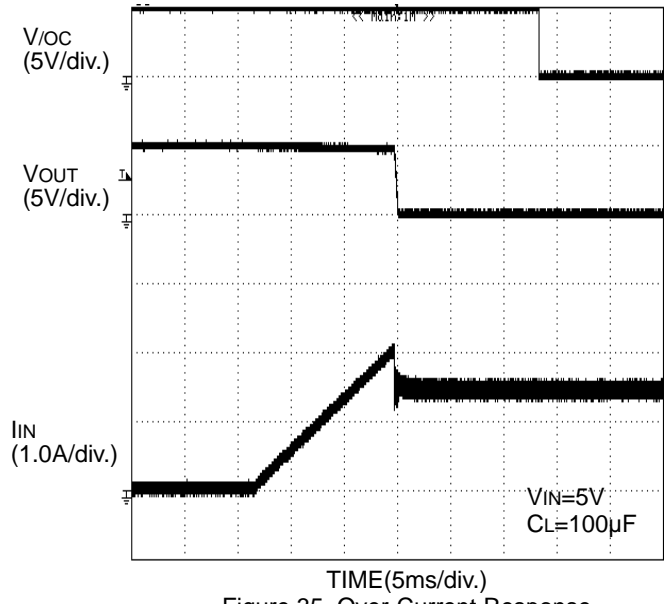
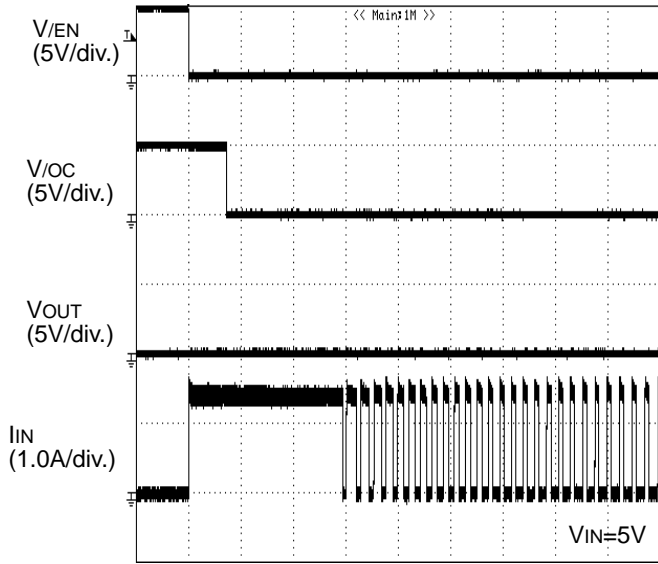
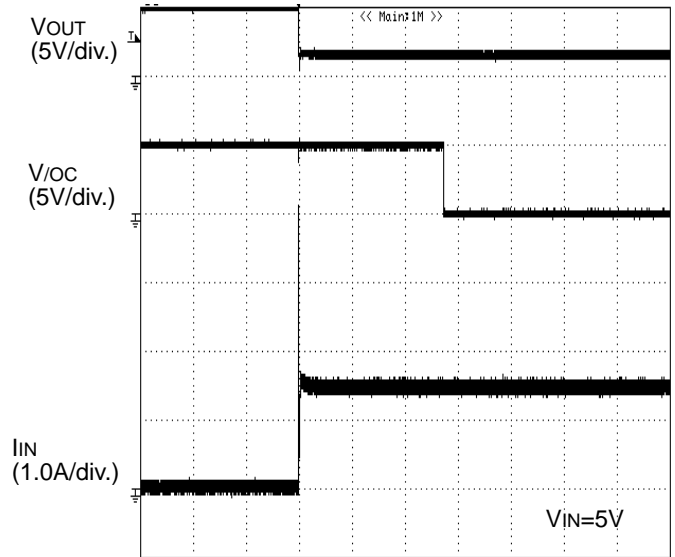

Figure 35. Over-Current Response Ramped Load

Typical Wave Forms (BD82023FVJ)



TIME(20ms/div.)  
Figure 36. Over-Current Response  
Enable to Shortcircuit



TIME(5ms/div.)  
Figure 37. Over-Current Response  
1 Load Connected at Enable

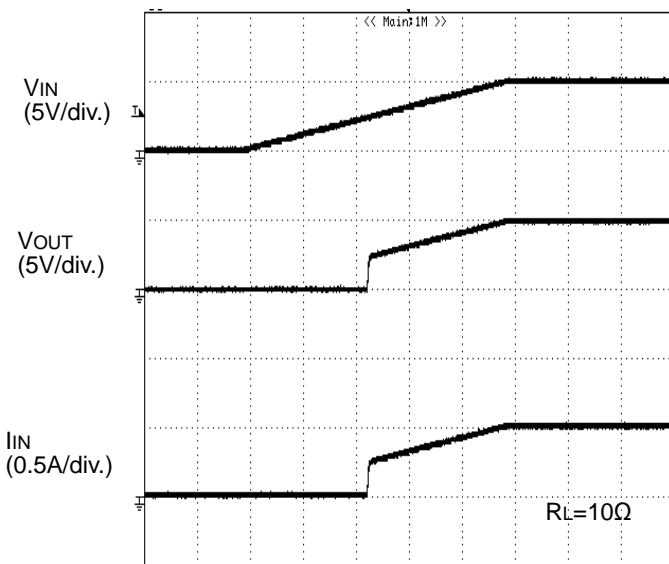

TIME(10ms/div.)  
Figure 38. UVLO Response  
Increasing VIN

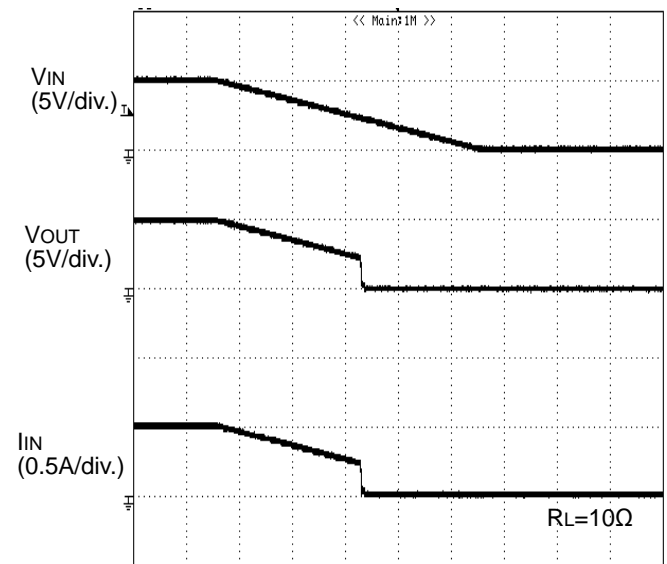

TIME(10ms/div.)  
Figure 39. UVLO Response  
Decreasing VIN

## Typical Application Circuit



Figure 40. Typical Application Circuit

## Application Information

When excessive current flows due to output short-circuit or overload ringing occurs because of inductance between power source line and IC. This may cause bad effects on IC operations. In order to avoid this case, connect a bypass capacitor  $C_{IN}$  across IN terminal and GND terminal of IC.  $1\mu\text{F}$  or higher is recommended. In order to decrease voltage fluctuations of power source line to IC, connect a low ESR capacitor in parallel with  $C_{IN}$ .  $10\mu\text{F}$  to  $100\mu\text{F}$  or higher is recommended.

Pull up /OC output via resistance value of  $10\text{k}\Omega$  to  $100\text{k}\Omega$ .

Set up a value for  $C_L$  which satisfies the application.

This system connection diagram does not guarantee operation as the intended application.

When using the circuit with changes to the external circuit values, make sure to leave an adequate margin for external components including static and transitional characteristics as well as the design tolerances of the IC.

## Functional Description

### 1. Switch Operation

IN terminal and OUT terminal are connected to the drain and the source of switch MOSFET respectively. The IN terminal is also used as power source input to internal control circuit.

When the switch is turned on from /EN control input, the IN terminal and OUT terminal are connected by a  $90\text{m}\Omega$ (Typ) switch. In ON status, the switch is bidirectional. Therefore, when the potential of OUT terminal is higher than that of the IN terminal, current flows from OUT terminal to IN terminal.

Since the parasitic diode between the drain and the source of switch MOSFET is canceled current flow from OUT to IN is prevented during off state.

### 2. Thermal Shutdown Circuit (TSD)

If over current would continue, the temperature of the IC would increase drastically. If the junction temperature reaches beyond  $130$  (Typ) during the condition of over current detection, thermal shutdown circuit operates and turns power switch off and outputs an error flag (/OC). Then, when the junction temperature decreases below  $120$  (Typ), power switch is turned on and error flag (/OC) is cancelled. Unless the cause of the increase of the chip's temperature is removed or the output of power switch is turned off, this operation repeats.

The thermal shutdown circuit operates when the switch is on (/EN signal is active).

### 3. Over-Current Detection (OCD)

The over-current detection circuit (OCD) limits current ( $I_{SC}$ ) and outputs error flag (/OC) when current flowing in each switch MOSFET exceeds a specified value. There are three cases when the OCD circuit is activated. The OCD operates when the switch is on (/EN signal is active).

- (1) When the switch is turned on while the output is in short-circuit status, the switch gets in current limit status immediately.
- (2) When the output short-circuits or when high current load is connected while the switch is on, very large current will flow until the over-current limit circuit reacts. When this happens, the over-current limit circuit is activated and the current limitation is carried out.
- (3) When the output current increases gradually, current limitation does not work until the output current exceeds the over-current detection value. When it exceeds the detection value, current limitation is carried out.

#### 4. Under-Voltage Lockout (UVLO)

UVLO circuit prevents the switch from turning on until  $V_{IN}$  exceeds 2.3V(Typ). If  $V_{IN}$  drops below 2.2V(Typ) while the switch is still on, then the UVLO will shut off the power switch. UVLO has a hysteresis of 100mV(Typ). Under-voltage lockout circuit works when the switch is on (/EN signal is active).

#### 5. Error Flag (/OC) Output

Error flag output is an N-MOS open drain output. Upon detection of over current or thermal shutdown, the output level becomes low.

Over-current detection has a delay filter. This delay filter prevents current detection flags from being sent during instantaneous events such as surge current due to switching or hot plug.

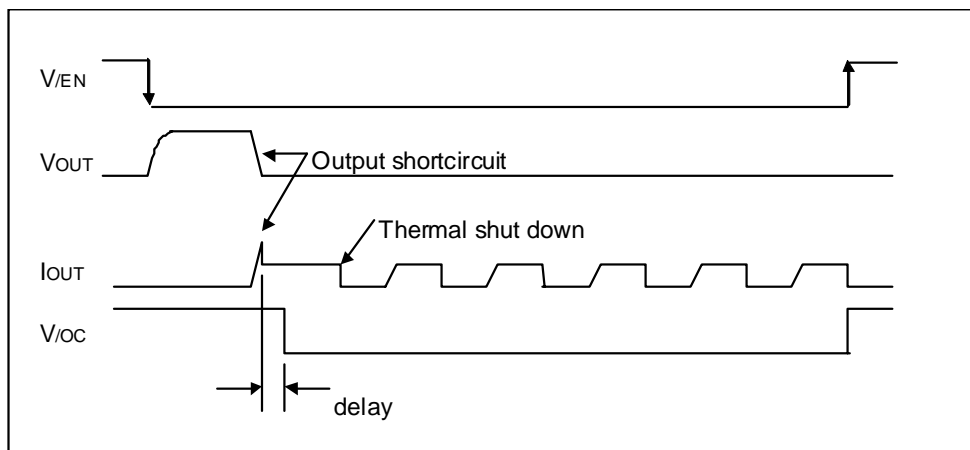

Figure 41. Over-Current Detection, Thermal Shutdown Timing

**Power Dissipation**

The power dissipation depends on output load, ambient temperature and PCB layout. The devices have current capacity of 1.5A respectively. Power dissipation can be calculated using the output current and the RON of the power switch as below.

$$P_d = R_{ON} \times I_{OUT}^2$$

The derating curve is shown below

TSSOP-B8J

(MSOP-8 JEDEC standard)

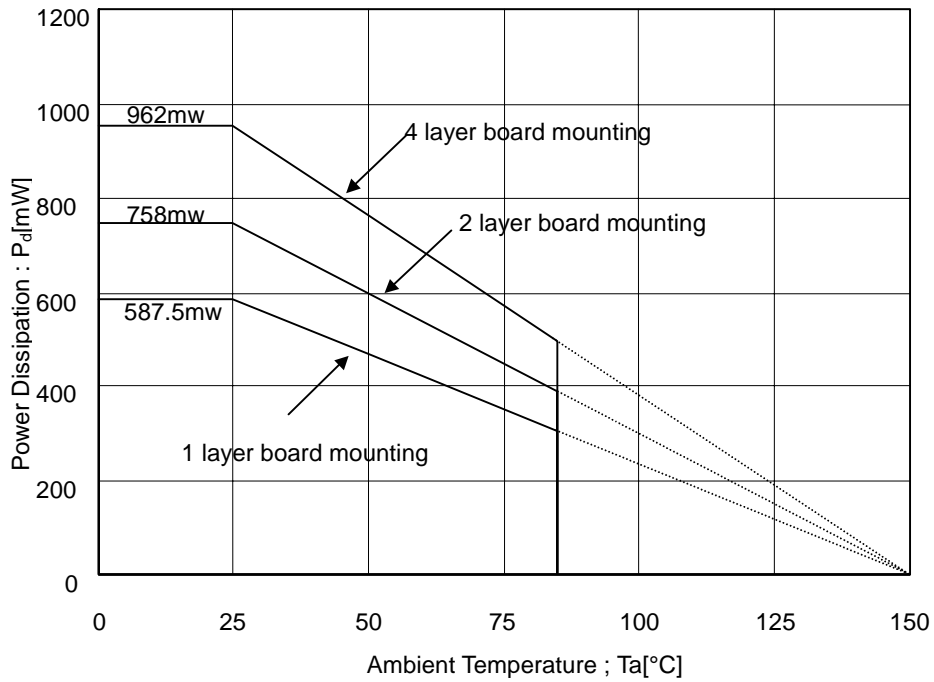

Note: IC is Mounted on 70mmx70mmx1.6mm glass-epoxy PCB. Derating is 4.7mW/ above Ta=25 .

Figure 42. Power Dissipation Curve (Pd-Ta Curve)



## I/O Equivalent Circuit

Symbol	Pin No.	Equivalent Circuit
EN(/EN)	4	
/OC	5	
OUT	6,7,8	

## Operational Notes

- Absolute Maximum Ratings**  
 Operating the IC over the absolute maximum ratings may damage the IC. In addition, it is impossible to predict all destructive situations such as short-circuit modes, open circuit modes, etc. Therefore, it is important to consider circuit protection measures, like adding a fuse, in case the IC is operated in a special mode exceeding the absolute maximum ratings.
- Operating Conditions**  
 These conditions represent a range within which the expected characteristics of the IC can be approximately obtained. The electrical characteristics are guaranteed under the conditions of each parameter.
- Reverse Connection of Power Supply Connector**  
 Connecting the power supply in reverse polarity can damage the IC. Take precautions against reverse polarity when connecting the power supply, such as mounting an external diode between the power supply and the IC's power supply terminals.
- Power Supply Line**  
 Design the PCB layout pattern to provide low impedance ground and supply lines. Separate the ground and supply lines of the digital and analog blocks to prevent noise in the ground and supply lines of the digital block from affecting the analog block. Furthermore, connect a capacitor to ground at all power supply pins. Consider the effect of temperature and aging on the capacitance value when using electrolytic capacitors.
- GND Voltage**  
 The voltage of the ground pin must be the lowest voltage of all pins of the IC at all operating conditions. Ensure that no pins are at a voltage below the ground pin at any time, even during transient condition.
- Short Circuit between Terminals and Erroneous Mounting**  
 Ensure that when mounting the IC on the PCB the direction and position are correct. Incorrect mounting may result in damaging the IC. Avoid nearby pins being shorted to each other especially to ground. Inter-pin shorts could be due to many reasons such as metal particles, water droplets (in very humid environment) and unintentional solder bridge deposited in between pins during assembly to name a few.
- Operation in Strong Electromagnetic Field**  
 Operating the IC in the presence of a strong electromagnetic field may cause the IC to malfunction.

8. Inspection with Set PCB  
When testing the IC on an application board, connecting a capacitor directly to a low-impedance output pin may subject the IC to stress. Always discharge capacitors completely after each process or step. The IC's power supply should always be turned off completely before connecting or removing it from the test setup during the inspection process. To prevent damage from electro static discharge, ground the IC during assembly and use similar precautions during transport and storage.
9. Input Terminals  
In the construction of this IC, P-N junctions are inevitably formed creating parasitic diodes or transistors. The operation of these parasitic elements can result in mutual interference among circuits, operational faults, or physical damage. Therefore, conditions which cause these parasitic elements to operate, such as applying a voltage to an input pin lower than the GND voltage should be avoided. Furthermore, do not apply a voltage to the input terminals when no power supply voltage is applied to the IC. Even if the power supply voltage is applied, make sure that the input terminals have voltages within the values specified in the electrical characteristics of this IC..
10. Ground Wiring Pattern  
When using both small-signal and large-current GND traces, the two ground traces should be routed separately but connected to a single ground at the reference point of the application board to avoid fluctuations in the small-signal ground caused by large currents. Also ensure that the GND traces of external components do not cause variations on the GND voltage. The power supply and ground lines must be as short and thick as possible to reduce line impedance.
11. External Capacitor  
When using a ceramic capacitor, determine the dielectric constant considering the change of capacitance with temperature and the decrease in nominal capacitance due to DC bias and others.
12. Thermal Shutdown Circuit (TSD)  
The IC incorporates a built-in thermal shutdown circuit, which is designed to turn off the IC when the internal temperature of the IC reaches a specified value. Do not continue to operate the IC after this function is activated. Do not use the IC in conditions where this function will always be activated.
13. Thermal Design  
Use a thermal design that allows for a sufficient margin by taking into account the permissible power dissipation (Pd) in actual operating conditions.

Ordering Information

B	D	8	2	0	2	3	F	V	J	-	E	2
Part No.		Part No.					Package FVJ : TSSOP-B8J (MSOP-8 JEDEC)			Packaging and forming specification E2: Embossed tape and reel		

Lineup

Over-Current Threshold	Control Logic	Part Number
2.0A	Active- Low	BD82023FVJ

Marking Diagram

TSSOP-B8J(TOP VIEW)

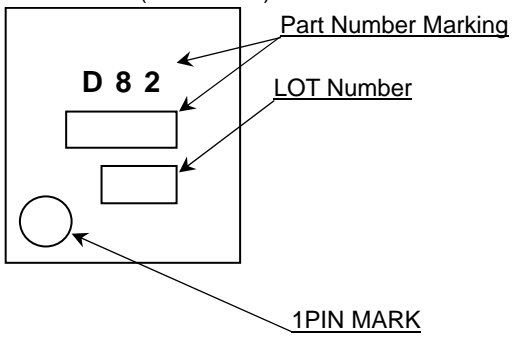

Part Number	Marking
BD82023FVJ	023

Physical Dimension, Tape and Reel Information

Package Name	TSSOP-B8J
--------------	-----------

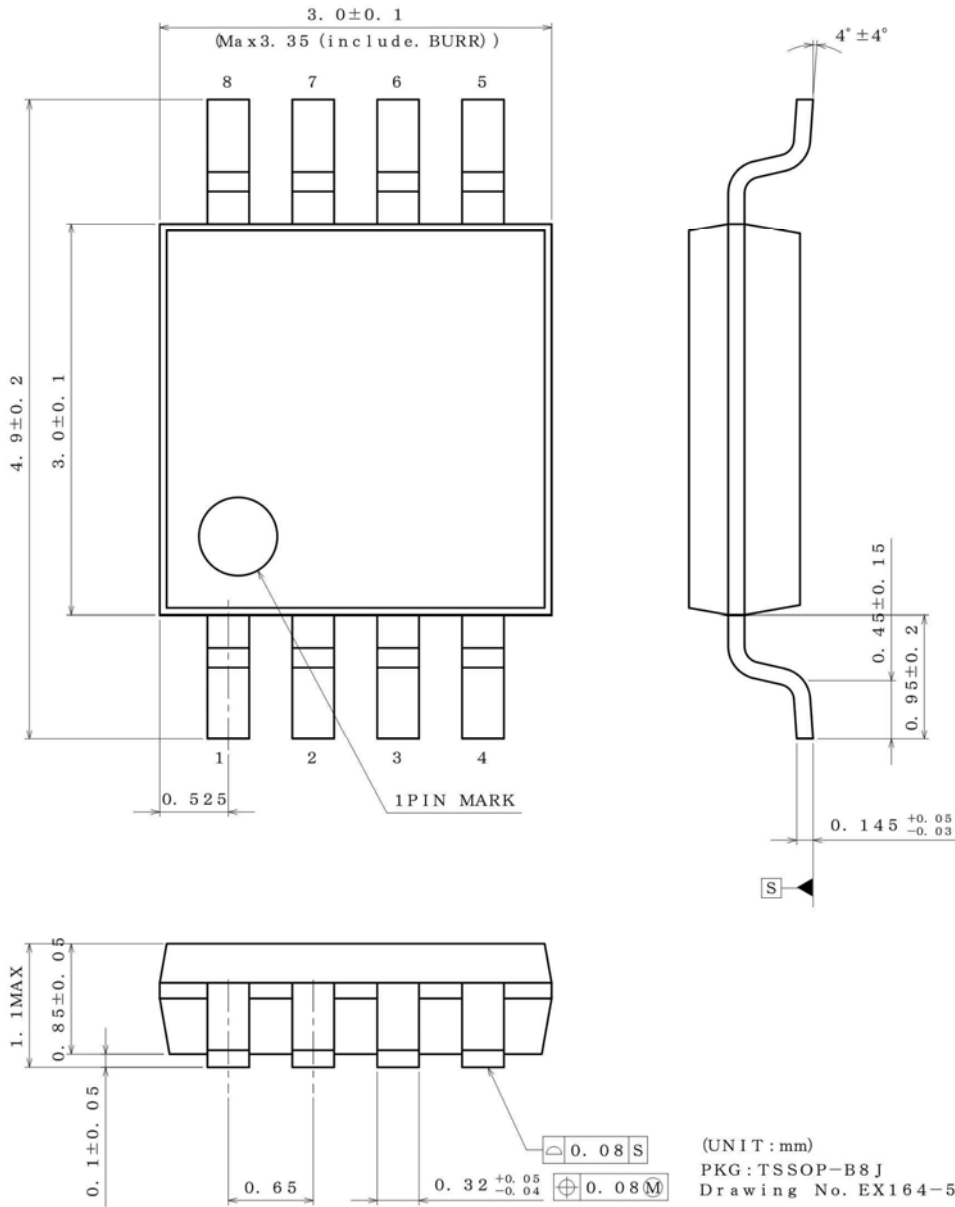

**Revision History**

Date	Revision	Changes
2.APR.2013	001	New Release
18.SEP.2013	002	Revised derating of Power Dissipation

# Notice

## Precaution on using ROHM Products

- Our Products are designed and manufactured for application in ordinary electronic equipments (such as AV equipment, OA equipment, telecommunication equipment, home electronic appliances, amusement equipment, etc.). If you intend to use our Products in devices requiring extremely high reliability (such as medical equipment <sup>(Note 1)</sup>, transport equipment, traffic equipment, aircraft/spacecraft, nuclear power controllers, fuel controllers, car equipment including car accessories, safety devices, etc.) and whose malfunction or failure may cause loss of human life, bodily injury or serious damage to property ("Specific Applications"), please consult with the ROHM sales representative in advance. Unless otherwise agreed in writing by ROHM in advance, ROHM shall not be in any way responsible or liable for any damages, expenses or losses incurred by you or third parties arising from the use of any ROHM's Products for Specific Applications.

(Note1) Medical Equipment Classification of the Specific Applications

JAPAN	USA	EU	CHINA
CLASS III	CLASS III	CLASS II b	CLASS III
CLASS IV		CLASS III	

- ROHM designs and manufactures its Products subject to strict quality control system. However, semiconductor products can fail or malfunction at a certain rate. Please be sure to implement, at your own responsibilities, adequate safety measures including but not limited to fail-safe design against the physical injury, damage to any property, which a failure or malfunction of our Products may cause. The following are examples of safety measures:
  - Installation of protection circuits or other protective devices to improve system safety
  - Installation of redundant circuits to reduce the impact of single or multiple circuit failure
- Our Products are designed and manufactured for use under standard conditions and not under any special or extraordinary environments or conditions, as exemplified below. Accordingly, ROHM shall not be in any way responsible or liable for any damages, expenses or losses arising from the use of any ROHM's Products under any special or extraordinary environments or conditions. If you intend to use our Products under any special or extraordinary environments or conditions (as exemplified below), your independent verification and confirmation of product performance, reliability, etc. prior to use, must be necessary:
  - Use of our Products in any types of liquid, including water, oils, chemicals, and organic solvents
  - Use of our Products outdoors or in places where the Products are exposed to direct sunlight or dust
  - Use of our Products in places where the Products are exposed to sea wind or corrosive gases, including Cl<sub>2</sub>, H<sub>2</sub>S, NH<sub>3</sub>, SO<sub>2</sub>, and NO<sub>2</sub>
  - Use of our Products in places where the Products are exposed to static electricity or electromagnetic waves
  - Use of our Products in proximity to heat-producing components, plastic cords, or other flammable items
  - Sealing or coating our Products with resin or other coating materials
  - Use of our Products without cleaning residue of flux (even if you use no-clean type fluxes, cleaning residue of flux is recommended); or Washing our Products by using water or water-soluble cleaning agents for cleaning residue after soldering
  - Use of the Products in places subject to dew condensation
- The Products are not subject to radiation-proof design.
- Please verify and confirm characteristics of the final or mounted products in using the Products.
- In particular, if a transient load (a large amount of load applied in a short period of time, such as pulse. is applied, confirmation of performance characteristics after on-board mounting is strongly recommended. Avoid applying power exceeding normal rated power; exceeding the power rating under steady-state loading condition may negatively affect product performance and reliability.
- De-rate Power Dissipation (Pd) depending on Ambient temperature (Ta). When used in sealed area, confirm the actual ambient temperature.
- Confirm that operation temperature is within the specified range described in the product specification.
- ROHM shall not be in any way responsible or liable for failure induced under deviant condition from what is defined in this document.

## Precaution for Mounting / Circuit board design

- When a highly active halogenous (chlorine, bromine, etc.) flux is used, the residue of flux may negatively affect product performance and reliability.
- In principle, the reflow soldering method must be used; if flow soldering method is preferred, please consult with the ROHM representative in advance.

For details, please refer to ROHM Mounting specification

**Precautions Regarding Application Examples and External Circuits**

1. If change is made to the constant of an external circuit, please allow a sufficient margin considering variations of the characteristics of the Products and external components, including transient characteristics, as well as static characteristics.
2. You agree that application notes, reference designs, and associated data and information contained in this document are presented only as guidance for Products use. Therefore, in case you use such information, you are solely responsible for it and you must exercise your own independent verification and judgment in the use of such information contained in this document. ROHM shall not be in any way responsible or liable for any damages, expenses or losses incurred by you or third parties arising from the use of such information.

**Precaution for Electrostatic**

This Product is electrostatic sensitive product, which may be damaged due to electrostatic discharge. Please take proper caution in your manufacturing process and storage so that voltage exceeding the Products maximum rating will not be applied to Products. Please take special care under dry condition (e.g. Grounding of human body / equipment / solder iron, isolation from charged objects, setting of ionizer, friction prevention and temperature / humidity control).

**Precaution for Storage / Transportation**

1. Product performance and soldered connections may deteriorate if the Products are stored in the places where:
  - [a] the Products are exposed to sea winds or corrosive gases, including Cl<sub>2</sub>, H<sub>2</sub>S, NH<sub>3</sub>, SO<sub>2</sub>, and NO<sub>2</sub>
  - [b] the temperature or humidity exceeds those recommended by ROHM
  - [c] the Products are exposed to direct sunshine or condensation
  - [d] the Products are exposed to high Electrostatic
2. Even under ROHM recommended storage condition, solderability of products out of recommended storage time period may be degraded. It is strongly recommended to confirm solderability before using Products of which storage time is exceeding the recommended storage time period.
3. Store / transport cartons in the correct direction, which is indicated on a carton with a symbol. Otherwise bent leads may occur due to excessive stress applied when dropping of a carton.
4. Use Products within the specified time after opening a humidity barrier bag. Baking is required before using Products of which storage time is exceeding the recommended storage time period.

**Precaution for Product Label**

QR code printed on ROHM Products label is for ROHM's internal use only.

**Precaution for Disposition**

When disposing Products please dispose them properly using an authorized industry waste company.

**Precaution for Foreign Exchange and Foreign Trade act**

Since our Products might fall under controlled goods prescribed by the applicable foreign exchange and foreign trade act, please consult with ROHM representative in case of export.

**Precaution Regarding Intellectual Property Rights**

1. All information and data including but not limited to application example contained in this document is for reference only. ROHM does not warrant that foregoing information or data will not infringe any intellectual property rights or any other rights of any third party regarding such information or data. ROHM shall not be in any way responsible or liable for infringement of any intellectual property rights or other damages arising from use of such information or data.:
2. No license, expressly or implied, is granted hereby under any intellectual property rights or other rights of ROHM or any third parties with respect to the information contained in this document.

**Other Precaution**

1. This document may not be reprinted or reproduced, in whole or in part, without prior written consent of ROHM.
2. The Products may not be disassembled, converted, modified, reproduced or otherwise changed without prior written consent of ROHM.
3. In no event shall you use in any way whatsoever the Products and the related technical information contained in the Products or this document for any military purposes, including but not limited to, the development of mass-destruction weapons.
4. The proper names of companies or products described in this document are trademarks or registered trademarks of ROHM, its affiliated companies or third parties.

**General Precaution**

1. Before you use our Products, you are requested to carefully read this document and fully understand its contents. ROHM shall not be in any way responsible or liable for failure, malfunction or accident arising from the use of any ROHM's Products against warning, caution or note contained in this document.
2. All information contained in this document is current as of the issuing date and subject to change without any prior notice. Before purchasing or using ROHM's Products, please confirm the latest information with a ROHM sales representative.
3. The information contained in this document is provided on an "as is" basis and ROHM does not warrant that all information contained in this document is accurate and/or error-free. ROHM shall not be in any way responsible or liable for any damages, expenses or losses incurred by you or third parties resulting from inaccuracy or errors of or concerning such information.



## X-ON Electronics

Largest Supplier of Electrical and Electronic Components

*Click to view similar products for [Power Switch ICs - Power Distribution](#) category:*

*Click to view products by [ROHM](#) manufacturer:*

Other Similar products are found below :

[TCK111G,LF\(S\)](#) [FPF1018](#) [DS1222](#) [TCK2065G,LF](#) [SZNCP3712ASNT3G](#) [MIC2033-05BYMT-T5](#) [MIC2033-12AYMT-T5](#) [MIC2033-05BYM6-T5](#) [SLG5NT1437VTR](#) [SZNCP3712ASNT1G](#) [DML1008LDS-7](#) [KTS1670EDA-TR](#) [KTS1640QGDV-TR](#) [KTS1641QGDV-TR](#) [NCV459MNWTBG](#) [FPF2260ATMX](#) [U6513A](#) [MIC2012YM-TR](#) [NCP45780IMN24RTWG](#) [MAX14919ATP+](#) [MC33882PEP](#) [TPS2104DBVR](#) [MIC2098-1YMT-TR](#) [MIC94062YMT TR](#) [MP6231DN-LF](#) [MIC2015-1.2YM6 TR](#) [MIC2075-2YM](#) [MIC94068YML-TR](#) [SIP32461DB-T2-GE1](#) [NCP335FCT2G](#) [TCK105G,LF\(S\)](#) [AP2411S-13](#) [AP2151DSG-13](#) [MIC94094YC6-TR](#) [MIC94093YC6-TR](#) [MIC94064YC6-TR](#) [MIC94061YMT-TR](#) [MIC2505-1YM](#) [MIC94305YMT-TR](#) [MIC94085YFT-TR](#) [MIC94081YFT-TR](#) [MIC94042YFL-TR](#) [MIC94041YFL-TR](#) [MIC2005-1.2YM6-TR](#) [TPS2032QDRQ1](#) [NCP333FCT2G](#) [BTS3050TFATMA1](#) [NCP331SNT1G](#) [TPS2092DR](#) [TPS2063DR](#)