

LED Drivers series for LCD Backlights

PWM pulse Generator for LCD Panels



BD9478F

●General Description

BD9478F is PWM pulse generator for LCD panel. This IC compares triangle waveform which is generated inside IC and external DC signal, and generates a PWM pulse. This PWM pulse is provided to LED driver and controls LED grayscale. PWM pulse frequency can be synchronized to external signal frequency inputted to SYNC terminal. Even if this frequency gets out of range, it works in the setting frequency, is protected and it always provides stable PWM pulse to LED driver.

●Key Specification

- Operating power supply voltage range: 4.5V to 5.5V
- Free Run frequency: 150Hz (CT=0.01μF)
- Operating Current: 2mA (typ.)
- Operating temperature range: -40°C to +85°C

●Applications

LED backlight of monitor, TV, NOTE PC, etc.

●Typical Application Circuit

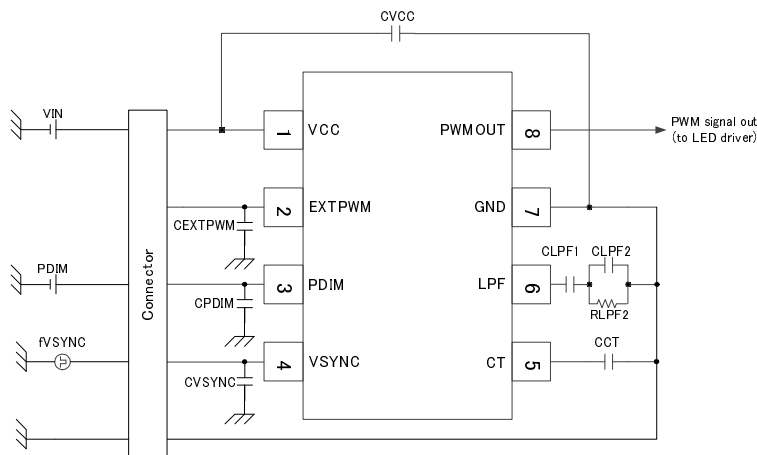


Figure 2. Typical Application Circuit

●Features

- The signal that the frequency synchronizes with the VSYNC signal is output to PWMOUT.
- The PWM pulse is generated with the DC signal of a triangular wave and PDIM generated with the LCT capacitor.
- When the VSYNC frequency exceeds the stipulated range, it fixes by a set frequency.
($f_{\text{VSYNC}} < f_{\text{PLLtyp}} \times 0.35 \rightarrow f_{\text{PLL}} = 0.36 \times f_{\text{PLLtyp}}$, $f_{\text{VSYNC}} > f_{\text{PLLtyp}} \times 2.75 \rightarrow f_{\text{PLL}} = 2.75 \times f_{\text{PLLtyp}}$)
- When VSYNC is a no signal input, the self-oscillation is operated by set frequency decided on the CT capacitance.
- When the pulse signal is input to the terminal EXTPWM, it shifts automatically to external PWM mode.

●Package

	W(Typ.)	D(Typ.)	H(Max.)
SOP-8:	5.00mm	6.20mm	1.71mm
Pin Pitch:			1.27mm

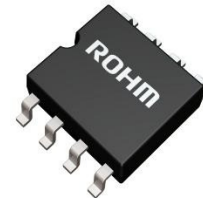


Figure 1. SOP-8

●Absolute maximum ratings (Ta=25°C)

Parameter	Symbol	Ratings	Unit
Power supply voltage	VCC	7	V
Operating Temperature Range	Ta(opr)	-40 ~ +85	°C
Storage Temperature Range	Tstg	-55 ~ +150	°C
Junction Temperature	Tjmax	150	°C
Power Dissipation	Pd	689※1	mW

*1 Decreases 5.5mW/°C at Ta=25°C or higher (When mounting a one-layer 70.0mmx70.0mmx1.6mm board)

●Operating Ratings (Ta = 25°C)

Parameter	Symbol	Range	Unit
Power supply voltage	VCC	4.5 ~ 5.5	V
VSYNC input frequency range	F_VSYNC	0.040 ~ 0.8	kHz
EXTPWM input PWM signal frequency range	F_EXTPWM	FCT ~ 30	kHz

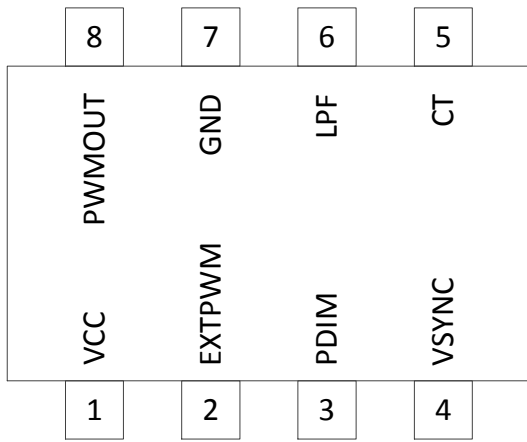
The operating conditions written above are constants of the IC unit. Be careful enough when setting the constant in the actual set. FCT is dimming frequency that oscillates itself when VSYNC terminal is input no signal

●External Components Recommended Range

Item	Symbol	Setting Range	Unit
VCC capacitance	CVCC	0.1 ~ 10	μF
PLL Burst OSC oscillation frequency setting capacitance	CT	0.040 ~ 0.8	μF

The operating conditions written above are constants of the IC unit. Be careful enough when setting the constant in the actual set.

●Pin Configuration



SOP-8

Figure 3. Pin Configuration

●Marking diagram and physical dimension

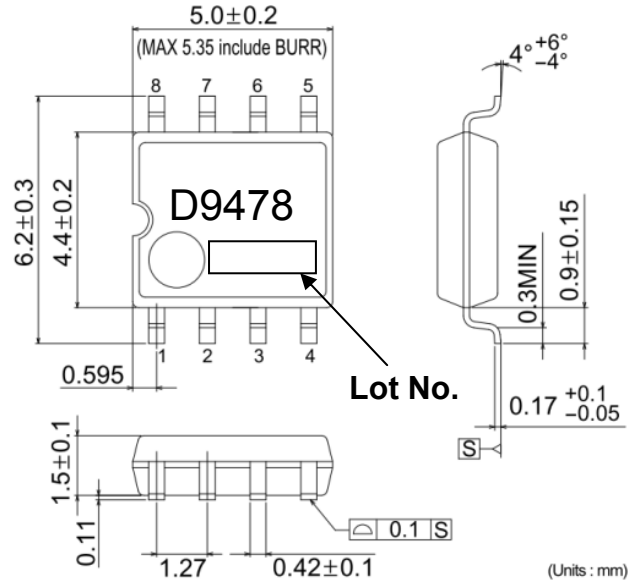


Figure 4. Physical Dimension

● **Electrical Characteristics** (Unless otherwise specified, Ta=25°C, VCC=5V)

Parameter	Symbol	Limit			Unit	Condition
		Min.	Typ.	Max.		
[Whole Device]						
Circuit Current during Operation	ICC	—	2	4	mA	PDIM=3V,CT=0.01uF VSYNC=EXTPWM=open
[UVLO Block]						
Release voltage	VUVLO	3.5	3.8	4.1	V	VCC=SWEEP UP
Hysteresis voltage	VUHYS	150	300	600	mV	VCC=SWEEP DOWN
[PLL Block]						
Oscillation frequency when VSYNC is input no signal	fCTNS	142	150	158	Hz	CT=0.01μF,LPF=0V
Triangle wave maximum voltage	VCTH	2.70	3.00	3.30	V	fCT=150Hz
Triangle wave minimum voltage	VCTL	0.40	0.50	0.60	V	fCT=150Hz
Synchronous signal abnormal judgment voltage, (at High frequency input)	CT_SYNC_DET1	2.612	2.750	2.888	V	LPF=2.0V→3.0V
Synchronous signal normal judgment voltage, (at High frequency input)	CT_SYNC_OKH	2.517	2.650	2.783	V	LPF=3.0V→2.0V
Internal RT voltage at Synchronous signal, abnormal judgment when High frequency input	VRTFH	-	2.750	-	V	LPF=3V
Synchronous signal abnormal judgment voltage, (at Low frequency input)	CT_SYNC_DET2	0.331	0.350	0.389	V	LPF=1.0V→0.1V
Synchronous signal normal judgment voltage, (at Low frequency input)	CT_SYNC_OKL	0.414	0.450	0.486	V	LPF=0.1V→1.0V
Internal RT voltage at Synchronous signal, abnormal judgment when High frequency input	VRTFL	-	0.360	-	V	LPF=0.25V
Switch voltage to internal fixed frequency	VINTF	0.10	0.15	0.20	V	LPF=1.0V→0.1V
Internal RT voltage at switched to internal fixed, frequency	VRTFI	-	0.900	-	V	LPF=0V
[Input pin (EXTPWM,PDIM,VSYNC)]						
Input High level	VIH	2.0	-	20	V	
Input Low level	VIL	-0.3	-	0.8	V	
Pull down resistance	RIPD	0.5	1.0	2.0	MΩ	
[Output pin (PWMOUT)]						
Output High level	VOH	4.3	4.85	-	V	Io=-1mA
Output Low level	VOL	-	0.1	0.5	V	Io=1mA

● Pin Descriptions

Pin No	Pin Name	In/Out	Function	Rating [V]
1	VCC	-	Power supply	-0.3~7
2	EXTPWM	In	External PWM signal input	-0.3~20
3	PDIM	In	DC signal input for Internal PWM	-0.3~20
4	VSYNC	In	Synchronous signal input	-0.3~20
5	CT	Out	Capacitance pin for VCO	-0.3~7
6	LPF	In/Out	LPF output for PLL	-0.3~7
7	GND	-	Ground	-
8	PWMOUT	Out	PWM dimming signal output	-0.3~7

● Pin ESD Type

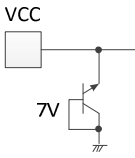
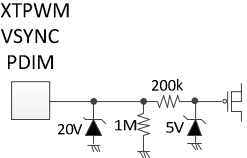
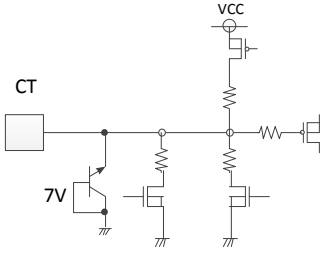
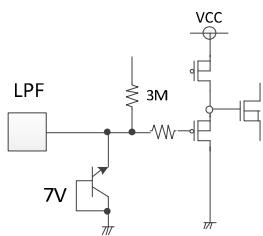

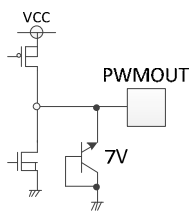
VCC	EXTPWM / VSYNC / PDIM	CT
		
LPF	GND	PWMOUT
		

Figure 5. Pin ESD Type

●Block Diagram

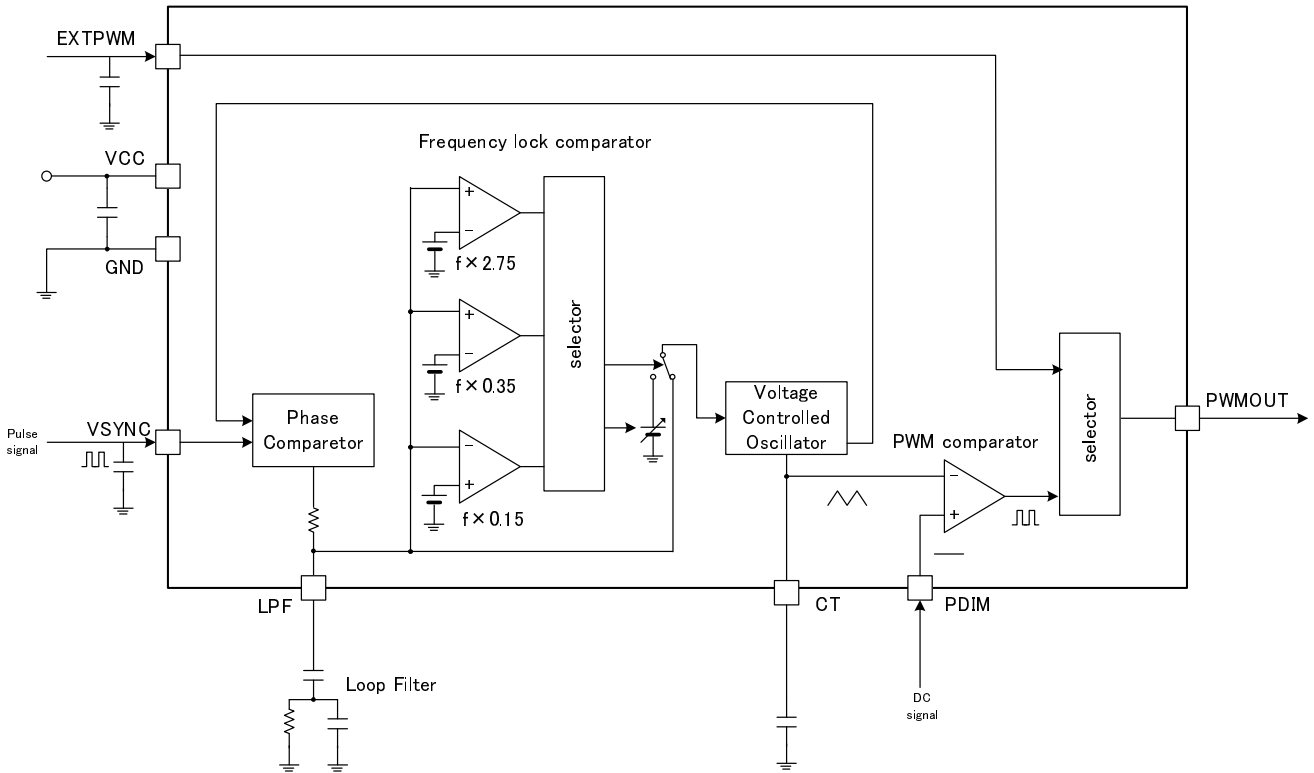


Figure 6. Block Diagram

● Typical Performance Curve

Figure 7. Operating Current (ICC) [mA] vs. VCC[V]

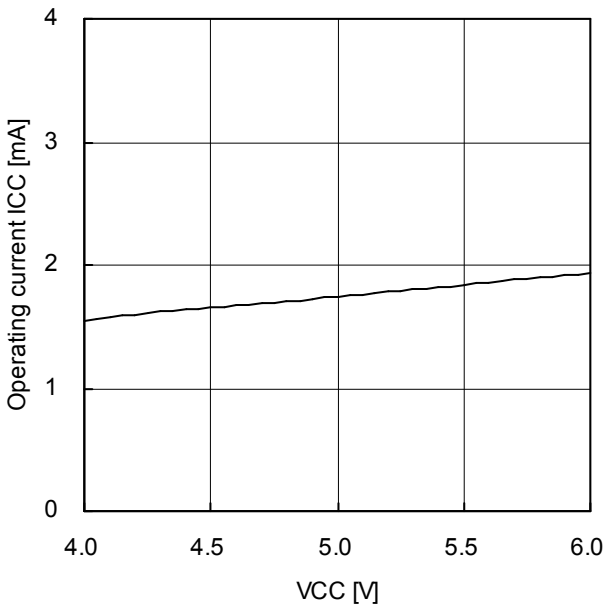


Figure 8. frequency fCT[Hz] vs. CT[nF]

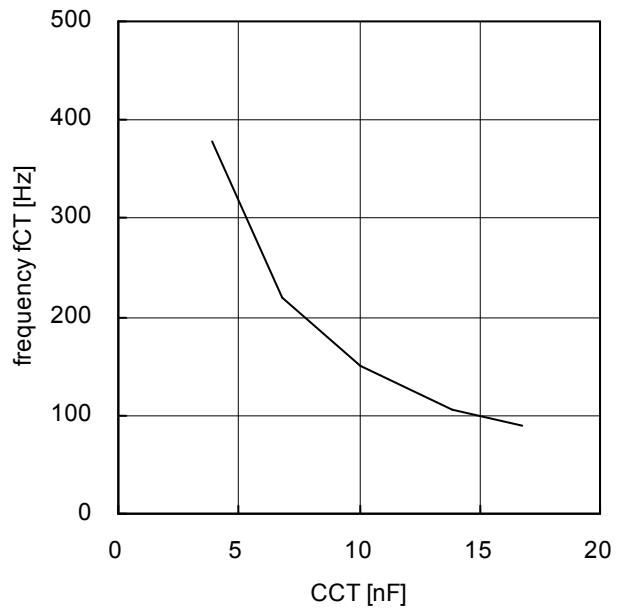


Figure 9. PWM DUTY [%] vs. PDIM[V]

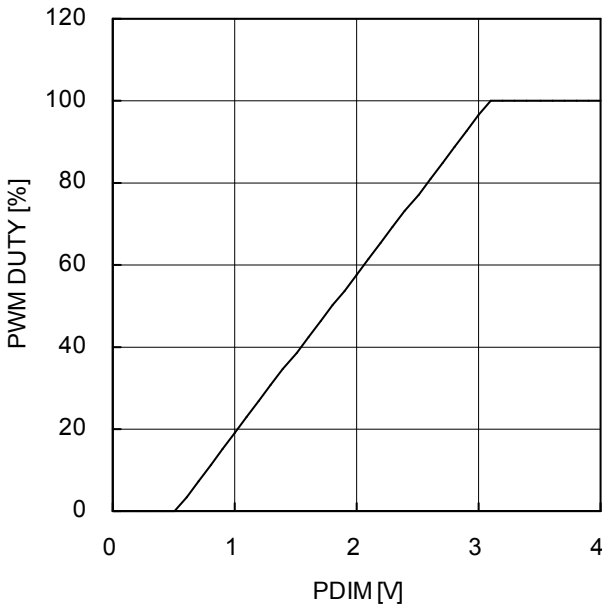


Figure 10. PWMOUT jitter [μs] vs. fCT[Hz]

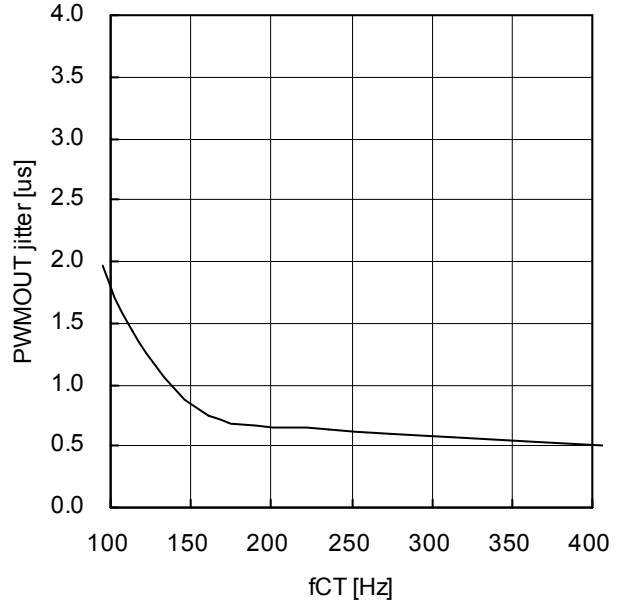


Figure 11. Start up waveform (Free Run mode)

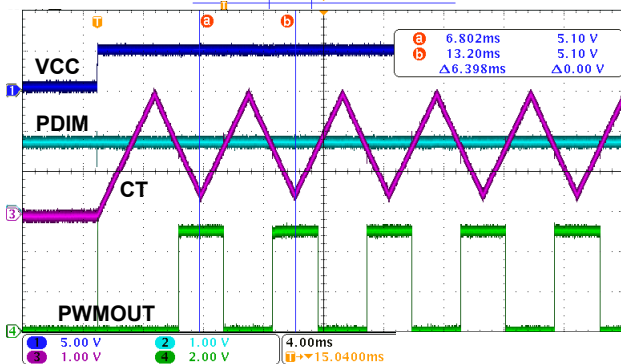
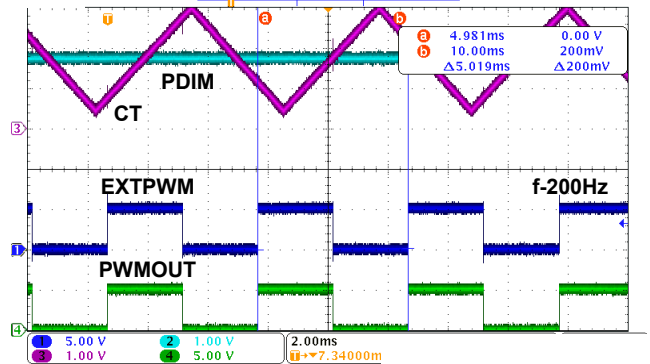


Figure 12. EXTPWM mode waveform



● Pin Function

OPin 1: VCC

Power supply pin of the IC. Input range is from 4.5V to 5.5V
Operation starts at VCC=3.8V(TYP.) or higher and shuts down at VCC=3.5V(TYP.) or lower.

OPin 2: EXTPWM

External PWM signal input terminal.
In case of the following equation, the signal input to EXTPWM is output directly to PWMOUT.
The equation ; $f(PLL) < 2 * f(EXTPWM)$
f(EXTPWM) ; frequency of signal input to EXTPWM
f(PLL) ; frequency of signal that synchronizes with VSYNC signal

OPin 3: PDIM

DC signal input terminal to generate internal PWM signal.
The PWM signal is generated with compare it with a triangular waveform in IC.
If PDIM input DC level is changed, PWM Duty can be changed.
PDIM input DC voltage range is from 0.5V to 3.0V. (PWM Duty is changed from 0% to 100%)

OPin 4: VSYNC

Synchronous signal input terminal.
The signal that synchronizes with the frequency of the signal input to VSYNC is generated with PLL.
A triangular wave is generated based on the frequency of this synchronized signal, and the PWM pulse is generated with compare it with the PDIM signal

OPin 5: CT

Capacitor connection terminal that decides the oscillation frequency of VCO..
Please adjust the capacity of CT by the following equation so that the voltage of the terminal LPF may become 0.9V when the frequency of the signal that synchronizes is input.

$$CT = \frac{1.5}{f_{PLLtyp}[Hz]} \quad [uF]$$

OPin 6: LPF

Low pass filter connection pin.
The pulse signal output from Phase Comparator is smoothed by Low path filter, and it inputs to Voltage.
Controlled Oscillator (VCO).

OPin 7: GND

Ground pin of this IC.

OPin 8: PWMOUT

PWM signal output pin.
The PWM signal generated in IC is output.

●About Dimming Function

Burst Frequency Free Run Function

Because PLL is incorporated, Free Run operation is possible for burst frequency.

PLL circuit will operate like it synchronizes with the frequency of signal input to VSYNC pin.

Then, the voltage that is in proportion to the frequency will be generated in LPF pin.

When LPF pin voltage becomes 0.35V or lower, it will judge the external burst frequency is abnormal and clumps with the frequency of f_{PLLmin} . Then, PLL frequency is changed to Free Run frequency. (note1)

When the burst frequency becomes normal and LPF pin becomes over 0.9V, it will return to the state that synchronizes with the burst frequency.(note2)

In the same way, when LPF pin becomes 2.75V or more, it will clump with the frequency of f_{PLLmax} .

When the burst frequency becomes normal and LPF2 pin becomes 2.65V or lower, it will return to the state that synchronizes with the burst frequency.

When LPF pin becomes 0.15V or lower, it will judge the external burst frequency is not inputted and switches to the frequency of f_{PLLtyp} .(Free Run mode)

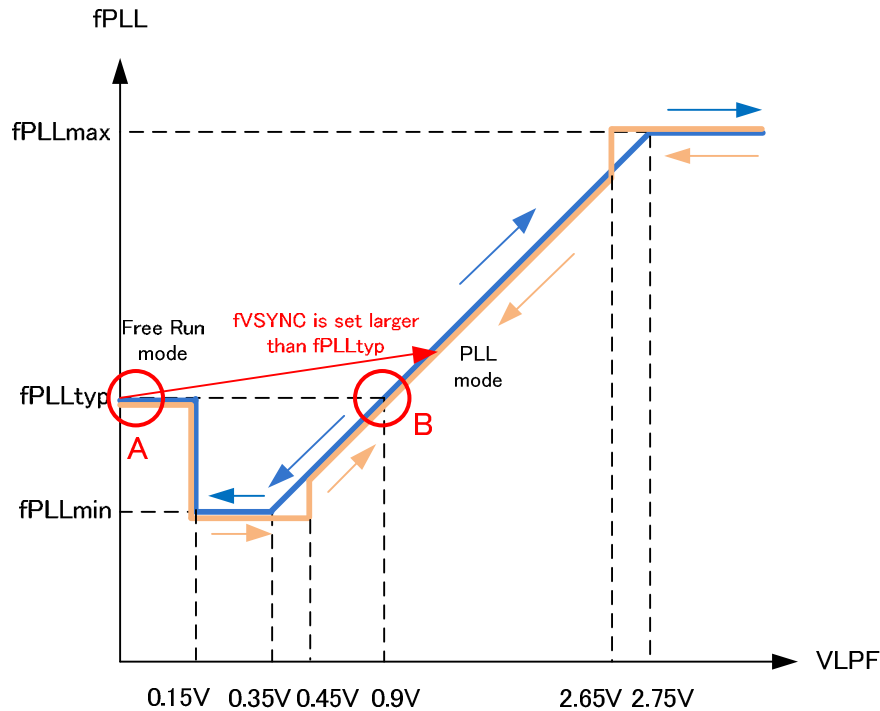


Figure 13.

Note1

If f_{VSYNC} is less than f_{PLLmin} , the input of VCO is fixed to 0.36V inside IC, and PWM frequency is fixed to f_{PLLmin} . However, since it is $f_{VSYNC} < f_{PLLmin}$, a LPF terminal approaches 0V. Then, it is set to $LPF < 0.15V$, and it shifts to Free Run mode and PWM frequency is set to f_{PLLtyp} .

Note2

In order to shift to PLL mode, it is necessary to input bigger frequency than Free Run frequency into VSYNC.

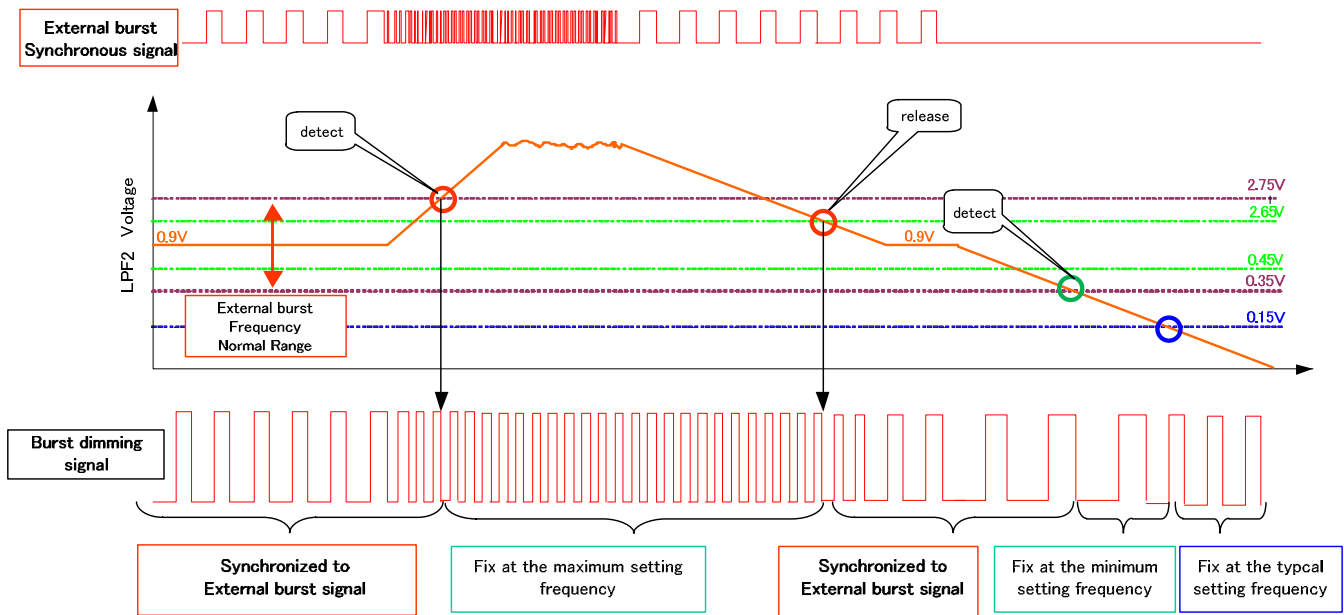


Figure 14.

(Free Run Operation Explanation)

For example, if you set $CT=0.01\mu F$ (At this time, f_{PLLtyp} is adjusted to 150 Hz.) and $f(VSYNC)=180Hz$, the LPF pin voltage becomes 1.2V.

The built-in VCO is proportional to the LPF pin voltage.

If VSYNC is inputted to low frequency and it becomes $LPF < 0.35V$ (at this time, $f < 58Hz$), it will clump at $f_{PLLmin}=58Hz$.

However, since it is $fVSYNC < f_{PLLmin}$, a LPF terminal approaches 0V.

Then, it is set to $LPF < 0.15V$, and it shifts to Free Run mode and PWM frequency is set to f_{PLLtyp} .

(at this time, $f=150Hz$). If $fVSYNC$ is larger than f_{PLLtyp} , PWM frequency will return to the frequency that synchronizes with $f(VSYNC)$.

If VSYNC is inputted high frequency and it becomes $LPF > 2.75V$ (at this time, $f > 343Hz$), it will clump at $f_{PLLmax}=343Hz$.

When synchronous signal is not inputted to VSYNC terminal, LPF voltage decreases and then it becomes $LPF < 0.15V$ (at this time, $f < 19Hz$), it oscillates typical frequency (at this time, $f=150Hz$).

Note: Please set $f(VSYNC)$ frequency to satisfy the following equations when you start up PLL mode.

And then, please change $f(VSYNC)$ frequency.

$$f(VSYNC) > f_{PLLtyp}, f_{PLLtyp} = 1.5/(CT[\mu F]) [Hz]$$

●Dimming Signal Automatic Selection Function

In this IC, even if either PWM dimming signal or DC dimming signal is inputted into the DUTY pin, it is automatically distinguished as DC or PWM in the IC.

By detecting 4 cycles of the PWM signal within the 8 cycles of the burst frequency in the IC, it will switch automatically to PWM dimming.

Therefore, set the burst frequency in the IC as follows:

$$(\text{Burst Frequency in the IC (same } f_{\text{SYNC}})) < 2 \times (\text{Externally inputted PWM signal (} f_{\text{EXTPWM}}))$$

Also, if you do not detect 4 cycles of the PWM signal within the 8 cycles of the burst frequency after switching to PWM dimming, it will automatically switch to DC dimming.

(a) When (Burst Frequency in the IC) $< 2 \times$ (Externally inputted PWM signal)

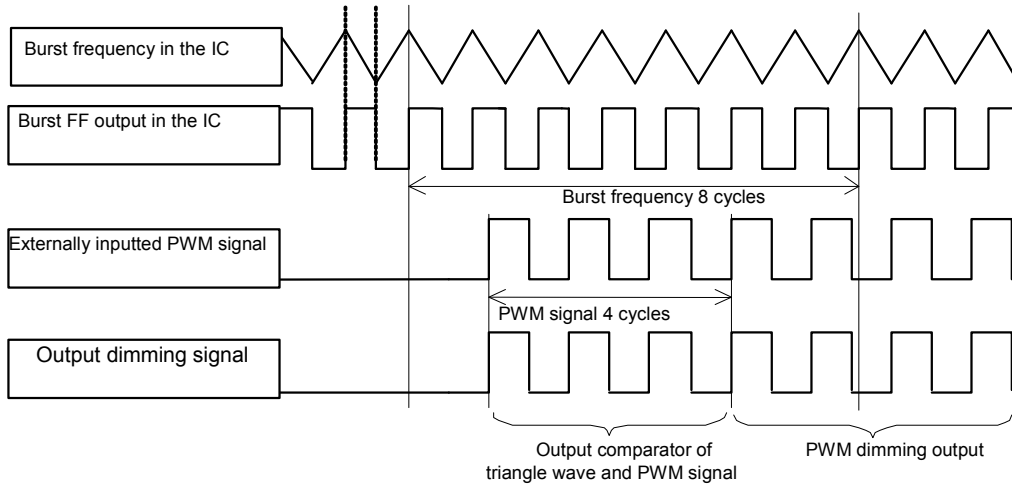


Figure 15.

(b) When (Burst Frequency in the IC) $\geq 2 \times$ (Externally inputted PWM signal)

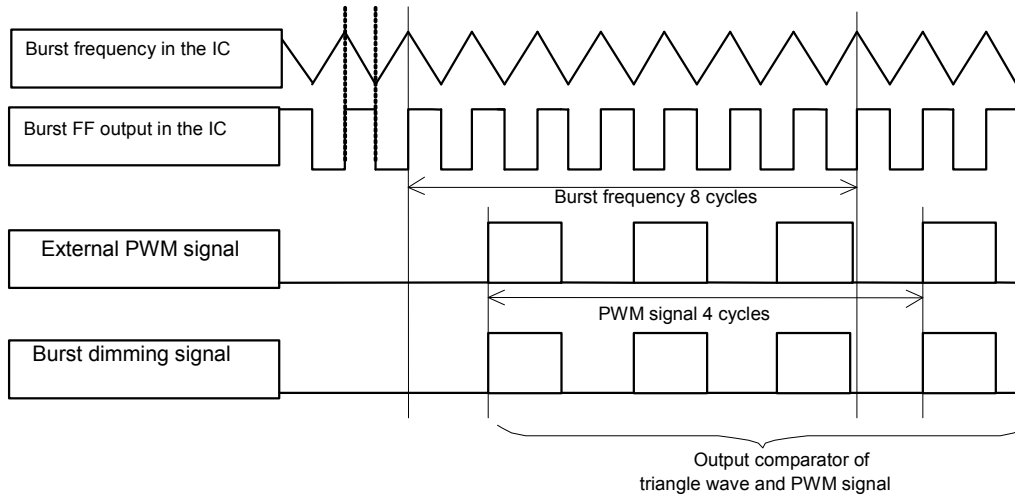


Figure 16.

●Operational Notes

- 1.) Although the quality of this product has been tightly controlled, deterioration or even destruction may occur if the absolute maximum ratings, such as for applied pressure and operational temperature range, are exceeded. Furthermore, we are unable to assume short or open mode destruction conditions. If special modes which exceed the absolute maximum ratings are expected, physical safety precautions such as fuses should be considered.
- 2.) The IC can destruct from reverse connection of the power supply connector. Precautions, such as inserting a diode between the external power supply and IC power terminal, should be taken as protection against reverse connection destruction.
- 3.) When attaching to the printed substrate, pay special attention to the direction and proper placement of the IC. If the IC is attached incorrectly, it may be destroyed.
Destruction can also occur when there is a short, which can be caused by foreign objects entering between outputs or an output and the power GND.
- 4.) Because there is a return of current regenerated by back EMF of the external coil, the capacity value should be determined after confirming that there are no problems with characteristics such as capacity loss at low temperatures with electrolysis condensers, for example by placing a condenser between the power supply and GND as a route for the regenerated current.
- 5.) The potential of the GND pin should be at the minimum potential during all operation status
- 6.) Heat design should consider power dissipation (Pd) during actual use and margins should be set with plenty of room.
- 7.) Exercise caution when operating in strong magnet fields, as errors can occur.
- 8.) When using this IC, it should be configured so that the output Tr should not exceed absolute maximum ratings and ASO. With CMOS ICs and ICs which have multiple power sources, there is a chance of rush current flowing momentarily, so exercise caution with power supply coupling capacity, power supply and width of GND pattern wiring and its layout.
- 9.) This IC has a built-in Temperature Protection Circuit (TSD circuit). The temperature protection circuit (TSD circuit) is only to cut off the IC from thermal runaway, and has not been designed to protect or guarantee the IC. Therefore, the user should not plan to activate this circuit with continued operation in mind.
- 10.) If a condenser is connected to a pin with low impedance when inspecting the set substrate, stress may be placed on the IC, so there should be a discharge after each process. Furthermore, when connecting a jig for the inspection process, the power must first be turned OFF before connection and inspection, and turned OFF again before removal.
- 11.) This IC is a monolithic IC, and between each element there is a P+ isolation and P substrate for element separation. There is a P-N junction formed between this P-layer and each element's N-layer, which makes up various parasitic elements. For example, when resistance and transistor are connected with a terminal as in figure 15:
○When $GND > (\text{terminal A})$ at the resistance, or $GND > (\text{terminal B})$ at the transistor (NPN), the P-N junction operates as a parasitic diode.
○Also, when $GND > (\text{terminal B})$ at the transistor, a parasitic NPN transistor operates by the N-layer of other elements close to the aforementioned parasitic diode.
With the IC's configuration, the production of parasitic elements by the relationships of the electrical potentials is inevitable. The operation of the parasitic elements can also interfere with the circuit operation, leading to malfunction and even destruction. Therefore, uses which cause the parasitic elements to operate, such as applying voltage to the input terminal which is lower than the GND (P-substrate), should be avoided.

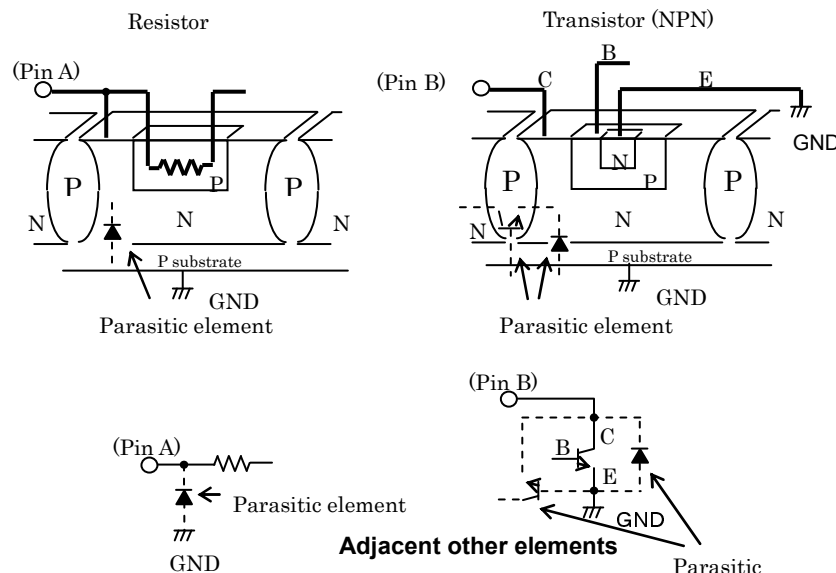


Figure 17. Example of Simple Structure of Monolithic IC

Status of this document

The Japanese version of this document is formal specification. A customer may use this translation version only for a reference to help reading the formal version.

If there are any differences in translation version of this document formal version takes priority

● Ordering Information

B D 9 4 7 8 F

Part Number

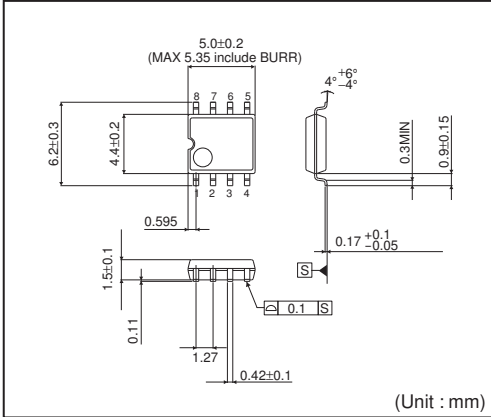
Package
F:SOP

XX

Packaging and forming specification
XX: Please confirm the formal name to our sales.

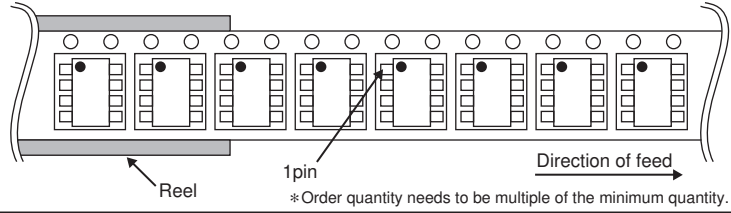
● Physical Dimension Tape and Reel Information

SOP8



<Tape and Reel information>

Tape	Embossed carrier tape
Quantity	2500pcs
Direction of feed	E2 (The direction is the 1pin of product is at the upper left when you hold reel on the left hand and you pull out the tape on the right hand)



Notice

●General Precaution

- 1) Before you use our Products, you are requested to carefully read this document and fully understand its contents. ROHM shall not be in any way responsible or liable for failure, malfunction or accident arising from the use of any ROHM's Products against warning, caution or note contained in this document.
- 2) All information contained in this document is current as of the issuing date and subject to change without any prior notice. Before purchasing or using ROHM's Products, please confirm the latest information with a ROHM sales representative.

●Precaution on using ROHM Products

- 1) Our Products are designed and manufactured for application in ordinary electronic equipments (such as AV equipment, OA equipment, telecommunication equipment, home electronic appliances, amusement equipment, etc.). If you intend to use our Products in devices requiring extremely high reliability (such as medical equipment, transport equipment, traffic equipment, aircraft/spacecraft, nuclear power controllers, fuel controllers, car equipment including car accessories, safety devices, etc.) and whose malfunction or failure may cause loss of human life, bodily injury or serious damage to property ("Specific Applications"), please consult with the ROHM sales representative in advance. Unless otherwise agreed in writing by ROHM in advance, ROHM shall not be in any way responsible or liable for any damages, expenses or losses incurred by you or third parties arising from the use of any ROHM's Products for Specific Applications.
- 2) ROHM designs and manufactures its Products subject to strict quality control system. However, semiconductor products can fail or malfunction at a certain rate. Please be sure to implement, at your own responsibilities, adequate safety measures including but not limited to fail-safe design against the physical injury, damage to any property, which a failure or malfunction of our Products may cause. The following are examples of safety measures:
 - [a] Installation of protection circuits or other protective devices to improve system safety
 - [b] Installation of redundant circuits to reduce the impact of single or multiple circuit failure
- 3) Our Products are designed and manufactured for use under standard conditions and not under any special or extraordinary environments or conditions, as exemplified below. Accordingly, ROHM shall not be in any way responsible or liable for any damages, expenses or losses arising from the use of any ROHM's Products under any special or extraordinary environments or conditions. If you intend to use our Products under any special or extraordinary environments or conditions (as exemplified below), your independent verification and confirmation of product performance, reliability, etc. prior to use, must be necessary:
 - [a] Use of our Products in any types of liquid, including water, oils, chemicals, and organic solvents
 - [b] Use of our Products outdoors or in places where the Products are exposed to direct sunlight or dust
 - [c] Use of our Products in places where the Products are exposed to sea wind or corrosive gases, including Cl₂, H₂S, NH₃, SO₂, and NO₂
 - [d] Use of our Products in places where the Products are exposed to static electricity or electromagnetic waves
 - [e] Use of our Products in proximity to heat-producing components, plastic cords, or other flammable items
 - [f] Sealing or coating our Products with resin or other coating materials
 - [g] Use of our Products without cleaning residue of flux (even if you use no-clean type fluxes, cleaning residue of flux is recommended); or Washing our Products by using water or water-soluble cleaning agents for cleaning residue after soldering
 - [h] Use of the Products in places subject to dew condensation
- 4) The Products are not subject to radiation-proof design.
- 5) Please verify and confirm characteristics of the final or mounted products in using the Products.
- 6) In particular, if a transient load (a large amount of load applied in a short period of time, such as pulse) is applied, confirmation of performance characteristics after on-board mounting is strongly recommended. Avoid applying power exceeding normal rated power; exceeding the power rating under steady-state loading condition may negatively affect product performance and reliability.
- 7) De-rate Power Dissipation (Pd) depending on Ambient temperature (Ta). When used in sealed area, confirm the actual ambient temperature.
- 8) Confirm that operation temperature is within the specified range described in the product specification.
- 9) ROHM shall not be in any way responsible or liable for failure induced under deviant condition from what is defined in this document.

●Precaution for Mounting / Circuit board design

- 1) When a highly active halogenous (chlorine, bromine, etc.) flux is used, the residue of flux may negatively affect product performance and reliability.
- 2) In principle, the reflow soldering method must be used; if flow soldering method is preferred, please consult with the ROHM representative in advance.

For details, please refer to ROHM Mounting specification

●Precautions Regarding Application Examples and External Circuits

- 1) If change is made to the constant of an external circuit, please allow a sufficient margin considering variations of the characteristics of the Products and external components, including transient characteristics, as well as static characteristics.
- 2) You agree that application notes, reference designs, and associated data and information contained in this document are presented only as guidance for Products use. Therefore, in case you use such information, you are solely responsible for it and you must exercise your own independent verification and judgment in the use of such information contained in this document. ROHM shall not be in any way responsible or liable for any damages, expenses or losses incurred by you or third parties arising from the use of such information.

●Precaution for Electrostatic

This Product is electrostatic sensitive product, which may be damaged due to electrostatic discharge. Please take proper caution in your manufacturing process and storage so that voltage exceeding the Products maximum rating will not be applied to Products. Please take special care under dry condition (e.g. Grounding of human body / equipment / solder iron, isolation from charged objects, setting of Ionizer, friction prevention and temperature / humidity control).

●Precaution for Storage / Transportation

- 1) Product performance and soldered connections may deteriorate if the Products are stored in the places where:
 - [a] the Products are exposed to sea winds or corrosive gases, including Cl₂, H₂S, NH₃, SO₂, and NO₂
 - [b] the temperature or humidity exceeds those recommended by ROHM
 - [c] the Products are exposed to direct sunshine or condensation
 - [d] the Products are exposed to high Electrostatic
- 2) Even under ROHM recommended storage condition, solderability of products out of recommended storage time period may be degraded. It is strongly recommended to confirm solderability before using Products of which storage time is exceeding the recommended storage time period.
- 3) Store / transport cartons in the correct direction, which is indicated on a carton with a symbol. Otherwise bent leads may occur due to excessive stress applied when dropping of a carton.
- 4) Use Products within the specified time after opening a humidity barrier bag. Baking is required before using Products of which storage time is exceeding the recommended storage time period.

●Precaution for Product Label

QR code printed on ROHM Products label is for ROHM's internal use only.

●Precaution for Disposition

When disposing Products please dispose them properly using an authorized industry waste company.

●Precaution for Foreign Exchange and Foreign Trade act

Since our Products might fall under controlled goods prescribed by the applicable foreign exchange and foreign trade act, please consult with ROHM representative in case of export.

●Precaution Regarding Intellectual Property Rights

- 1) All information and data including but not limited to application example contained in this document is for reference only. ROHM does not warrant that foregoing information or data will not infringe any intellectual property rights or any other rights of any third party regarding such information or data. ROHM shall not be in any way responsible or liable for infringement of any intellectual property rights or other damages arising from use of such information or data.:
- 2) No license, expressly or implied, is granted hereby under any intellectual property rights or other rights of ROHM or any third parties with respect to the information contained in this document.

●Other Precaution

- 1) The information contained in this document is provided on an "as is" basis and ROHM does not warrant that all information contained in this document is accurate and/or error-free. ROHM shall not be in any way responsible or liable for any damages, expenses or losses incurred by you or third parties resulting from inaccuracy or errors of or concerning such information.
- 2) This document may not be reprinted or reproduced, in whole or in part, without prior written consent of ROHM.
- 3) The Products may not be disassembled, converted, modified, reproduced or otherwise changed without prior written consent of ROHM.
- 4) In no event shall you use in any way whatsoever the Products and the related technical information contained in the Products or this document for any military purposes, including but not limited to, the development of mass-destruction weapons.
- 5) The proper names of companies or products described in this document are trademarks or registered trademarks of ROHM, its affiliated companies or third parties.

X-ON Electronics

Largest Supplier of Electrical and Electronic Components

Click to view similar products for [LED Lighting Drivers](#) category:

Click to view products by [ROHM](#) manufacturer:

Other Similar products are found below :

[LV5235V-MPB-H](#) [MB39C602PNF-G-JNEFE1](#) [MIC2871YMK-T5](#) [AL1676-10BS7-13](#) [AL1676-20AS7-13](#) [AP5726WUG-7](#) [ICL8201](#)
[IS31BL3228B-UTLS2-TR](#) [IS31BL3506B-TTLS2-TR](#) [AL3157F-7](#) [LV52204MTTBG](#) [AP5725WUG-7](#) [STP4CMPQTR](#) [NCL30086BDR2G](#)
[CAT4004BHU2-GT3](#) [LV52207AXA-VH](#) [AP1694AS-13](#) [TLE4242EJ](#) [AS3688](#) [IS31LT3172-GRLS4-TR](#) [TLD2311EL](#) [KTD2694EDQ-TR](#)
[KTZ8864EJAA-TR](#) [IS32LT3174-GRLA3-TR](#) [MP2488DN-LF-Z](#) [NLM0010XTSA1](#) [AL1676-20BS7-13](#) [ZXLD1370QESTTC](#) [MPQ7220GF-](#)
[AEC1-P](#) [MPQ7220GR-AEC1-P](#) [MPQ4425BGJ-AEC1-P](#) [MPQ7220GF-AEC1-Z](#) [MPQ7220GR-AEC1-Z](#) [MPQ4425BGJ-AEC1-Z](#)
[IS31FL3737B-QFLS4-TR](#) [IS31FL3239-QFLS4-TR](#) [KTD2058EUAC-TR](#) [KTD2037EWE-TR](#) [DIO5662ST6](#) [IS31BL3508A-TTLS2-TR](#)
[KTD2026BEWE-TR](#) [MAX20052CATC/V+](#) [MAX25606AUP/V+](#) [BD6586MUV-E2](#) [BD9206EFV-E2](#) [LYT4227E](#) [LYT6079C-TL](#)
[MP3394SGF-P](#) [MP4689AGN-P](#) [MPQ4425AGQB-AEC1-Z](#)