

Ambient Light Sensor ICs

Digital 16bit Serial Output Type Ambient Light Sensor IC

BH1780GLI

No.11046ECT08

●Descriptions

BH1780GLI is a digital Ambient Light Sensor IC for I²C bus interface. This IC is the most suitable to obtain the ambient light data for adjusting LCD and Keypad backlight power of Mobile phone. It is possible to detect wide range at High resolution. (1 - 65535 lx).

●Features

- 1) I²C bus Interface (f/s mode support, Slave address : "0101001")
- 2) Spectral responsibility is approximately human eye response
- 3) Illuminance to Digital Converter
- 4) Wide range and High resolution. (1 – 65535 lx)
- 5) Low Current by power down function
- 6) 50Hz / 60Hz Light noise reject-function
- 7) 1.8V Logic input interface
- 8) No need any external parts
- 9) Light source dependency is little.
(ex. Incandescent Lamp. Fluorescent Lamp. Halogen Lamp. White LED. Sun Light)
- 10) Small measurement variation (+/- 20%)
- 11) The influence of infrared is very small.

●Applications

Mobile phone, LCD TV, NOTE PC, Portable game machine, Digital camera, Digital video camera, PDA, LCD display

●Absolute Maximum Ratings

Parameter	Symbol	Limits	Units
Supply Voltage	Vmax	4.5	V
Operating Temperature	Topr	-40~85	°C
Storage Temperature	Tstg	-40~100	°C
SDA Sink Current	I _{max}	7	mA
Power Dissipation	Pd	120※	mW

※ 70mm × 70mm × 1.6mm glass epoxy board. Decreasing rate is 1.6mW/°C for operating above Ta=25°C.

●Operating Conditions

Parameter	Symbol	Ratings			Units
		Min.	Typ.	Max.	
VCC Voltage	Vcc	2.3	2.5	3.0	V

●Electrical Characteristics (VCC = 2.5V, Ta = 25°C, unless otherwise noted)

Parameter	Symbol	Limits			Units	Conditions
		Min.	Typ.	Max.		
Supply Current	I _{CC1}	—	120	200	μA	Ev=100 lx ※
Powerdown Current	I _{CC2}	—	0.7	2.5	μA	No Input Light
Measurement Accuracy	S/A	0.8	1.0	1.2	Times	Sensor out / Actual lx Ev=1000 lx ※
Dark (0 lx) Sensor out	S0	0	0	2	count	
Measurement Time	t _M	—	150	250	ms	
SCL SDA input 'H' Voltage	V _{IH}	1.26	—	—	V	
SCL SDA input 'L' Voltage	V _{IL}	—	—	0.54	V	
SCL SDA input 'H' / 'L' Current	I _i	-10	—	10	μA	
I ² C SDA Output 'L' Voltage	V _{OL1}	0	—	0.4	V	IOL=3 mA
I ² C Rejected Spike pulse width	t _{SP}	—	100	—	ns	
SDA SCL Capacitance	C _i	—	7	—	pF	
I ² C SCL Clock Frequency	f _{SCL}	—	—	400	kHz	
I ² C Hold Time (Repeated) START Condition	t _{HD;STA}	0.6	—	—	us	
I ² C 'L' Period of the SCL Clock	t _{LOW}	1.3	—	—	us	
I ² C 'H' Period of the SCL Clock	t _{HIGH}	0.6	—	—	us	
I ² C Set up time for a Repeated START Condition	t _{SU;STA}	0.6	—	—	us	
I ² C Data Hold Time	t _{HD;DAT}	0	—	—	us	
I ² C Data Setup Time	t _{SU;DAT}	100	—	—	ns	
I ² C Set up Time for STOP Condition	t _{SU;STO}	0.6	—	—	us	
I ² C Bus Free Time between a STOP and START Condition	t _{BUF}	1.3	—	—	us	
I ² C Data Valid Time	t _{VD;DAT}	—	—	0.9	us	
I ² C Data Valid Acknowledge Time	t _{VD;ACK}	—	—	0.9	us	

※ White LED is used as optical source.

●Block Diagram

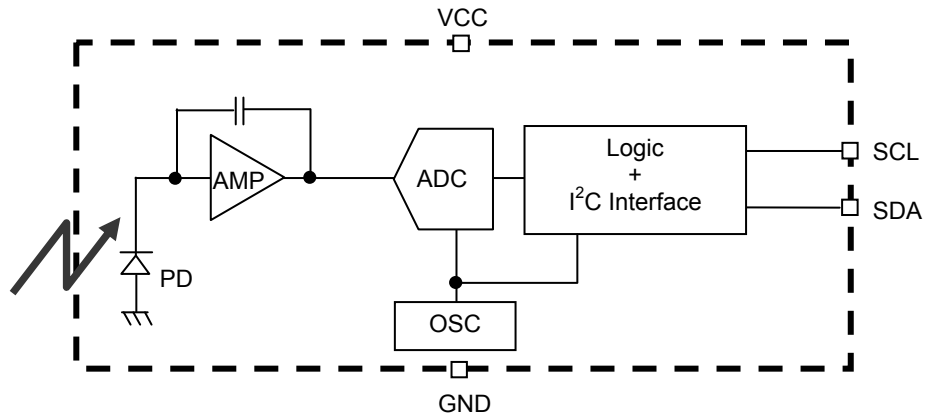

- PD
Photo diode with approximately human eye response.
- AMP
Integration-OPAMP for converting from PD current to voltage.
- ADC
AD converter for obtaining digital 16bit data.
- Logic + I²C Interface
Ambient Light Calculation and I²C bus Interface. It is including below register.
Data Register → This is for registration of Ambient Light Data. Initial Value is "0000_0000_0000_0000".
- OSC
Internal Oscillator (typ. 320kHz). It is CLK for internal logic.

●Reference Data

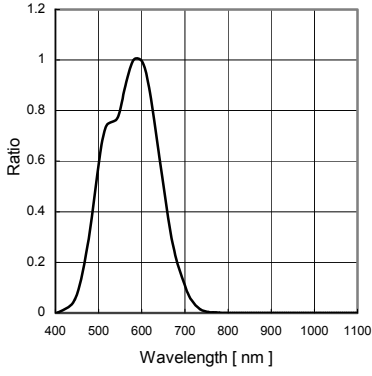

Fig.1 Spectral Response

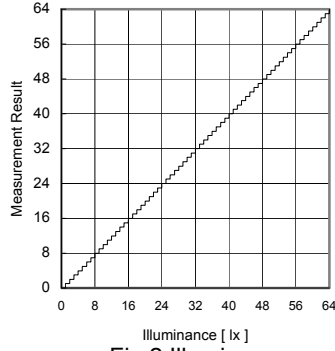

Fig.2 Illuminance – Measurement Result 1

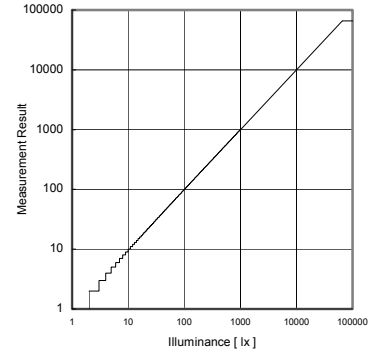

Fig.3 Illuminance – Measurement Result 2

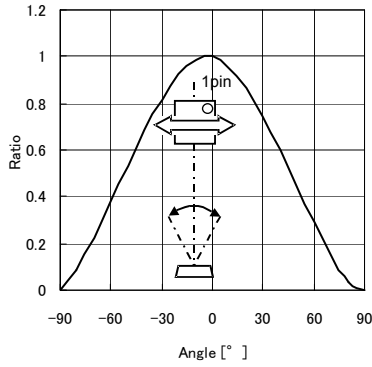

Fig.4 Directional Characteristics 1

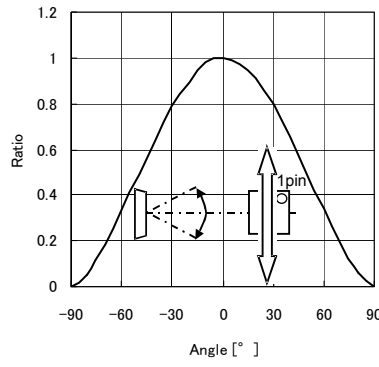

Fig.5 Directional Characteristics 2

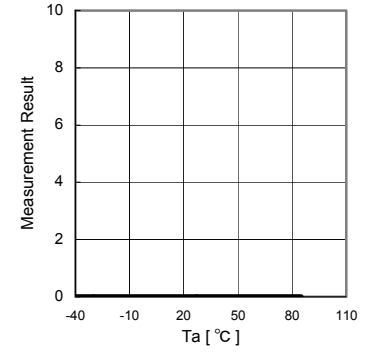

Fig.6 Dark Response

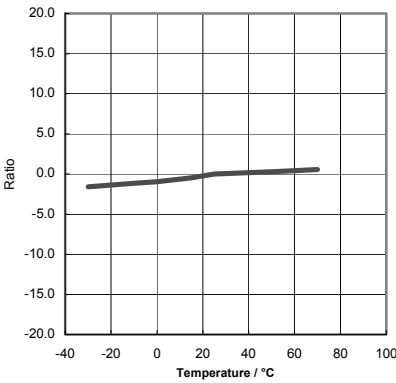

Fig.7 Measurement Result Temperature Dependency

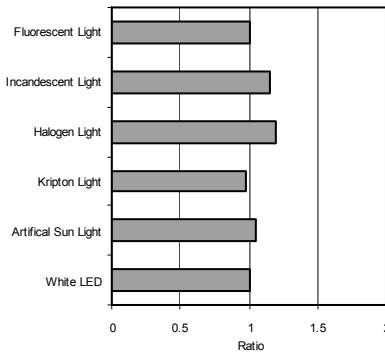

Fig.8 Light Source Dependency (Fluorescent Light is set to '1')

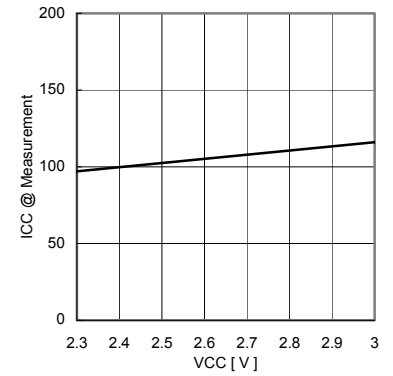

Fig.9 VCC – ICC (During measurement)

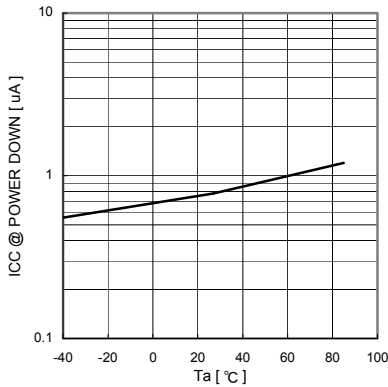

Fig.10 VCC – ICC@0 Lx (POWER DOWN)

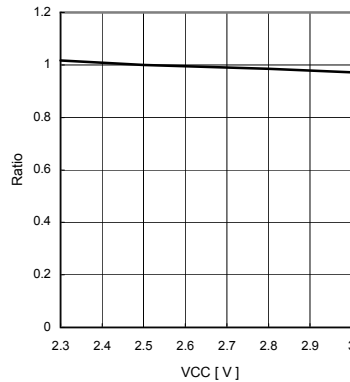

Fig.11 Measurement Result VCC Dependency

●Command Set

Address	Register name	Register function
--	COMMAND	Specifies register address
0h	CONTROL	Control of basic functions
Ah	PART ID	Part ID
Bh	MANUFACTURE ID	Manufacture ID
Ch	DATALOW	Low byte of ADC
Dh	DATAHIGH	High byte of ADC

○Command Register

7	6	5	4	3	2	1	0
CMD	XXX			ADDRESS			

default value 00h

Field	Bit	Description
CMD	7	Write 1
XXX	6 : 4	Write "000" Don't care if ADDRESS(Command Register< 3 : 0 >) is "0h" or "Ah" or "Bh" or "Ch" or "Dh".
ADDRESS	3 : 0	Register address

○Control Register (0h)

7	6	5	4	3	2	1	0
RES	RES	RES	RES	RES	RES	POWER	

default value 00h

Field	Bit	Description
RES	7 : 2	Write "000000"
POWER	1 : 0	"00" : Power down "01" : Resv "10" : Resv "11" : Power up

OPART ID Register (Ah)

The PART ID register provides device identification. It is a read only register.

7	6	5	4	3	2	1	0
PART NO				REV			

Field	Bit	Description
PARTNO	7 : 4	"1000"
REV	3 : 0	"0001"

OMANUFACTURE ID Register (Bh)

The MANUFACTURE ID register provides device identification. It is a read only register.

7	6	5	4	3	2	1	0
MANUFACTURE ID							

Field	Bit	Description
MANUFACTURE ID	7 : 0	"00000001"

OADC channel data registers (Ch, Dh)

Illuminance data register.

7	6	5	4	3	2	1	0
CHANNEL DATA							

Register	Address	Bit	Description
DATALOW	Ch	7 : 0	Lower byte
DATAHIGH	Dh	7 : 0	Upper byte

●Lux calculation

Measurement result is registered to ADC channel data registers(Ch, Dh) in below format.

DATALOW (Ch)

7	6	5	4	3	2	1	0
2^7	2^6	2^5	2^4	2^3	2^2	2^1	2^0

DATAHIGH (Dh)

7	6	5	4	3	2	1	0
2^{15}	2^{14}	2^{13}	2^{12}	2^{11}	2^{10}	2^9	2^8

This is an example for DATA to Lux conversion when DATA Register values are seeing in below condition.

ex)

DATA Low Byte = "1001_0000"

DATA High Byte = "1000_0011"

$$(2^{15} + 2^9 + 2^8 + 2^7 + 2^4) \div 33680 [lx]$$

●Measurement sequence example from "Write instruction" to "Read measurement result"



from Master to Slave



from Slave to Master

① Send Power up instruction.

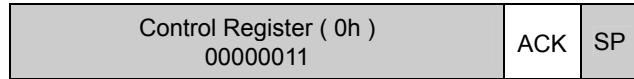

② Change ADDRESS Field of Control Register to Ch(DATALOW).



Wait 150ms until Measurement result is output.

③ Read measurement result.

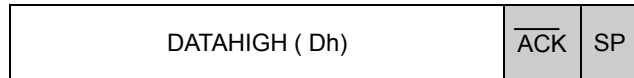

④ Wait 150ms until measurement result is updated.

⑤ Read measurement result.

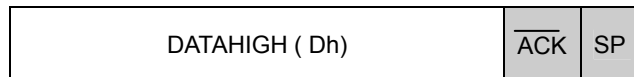
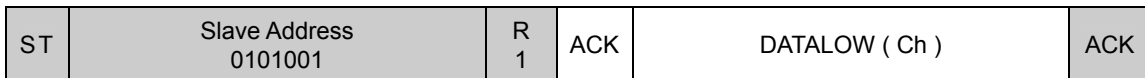

⑥ Send Power down instruction

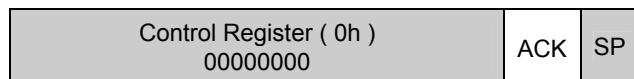
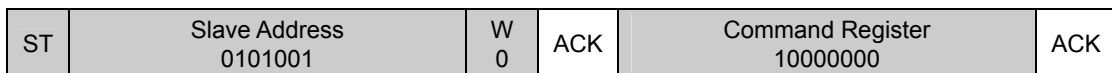

● I²C Bus Communication

1) Slave Address "0101001"

2) Main write Format

1. Write to Command Register

ST	Slave Address 0101001	W 0	ACK	Data to Command Register 1000XXXX	ACK	SP
----	--------------------------	--------	-----	--------------------------------------	-----	----

※ Data<7:4> must be "1000"

2. Write to Control Register

ST	Slave Address 0101001	W 0	ACK	Data to Control Register 000000XX	ACK	SP
----	--------------------------	--------	-----	--------------------------------------	-----	----

※ Data<7:2> must be "000000"

※ It is necessary that ADDRESS Field of Command Register must set "0000".

3. Write to Command Register and Control Register

ST	Slave Address 0101001	W 0	ACK	Command Register 1000XXXX	ACK
----	--------------------------	--------	-----	------------------------------	-----

Control Register (0h) 000000XX	ACK	SP
-------------------------------------	-----	----

3) Main read Format

ST	Slave Address 0101001	R 1	ACK	Data specified at ADDRESS Field of Command Register	ACK
----	--------------------------	--------	-----	--	-----

Data specified at ADDRESS Field of Command Register+1	ACK	ACK	Data specified at ADDRESS Field of Command Register +N	NACK	SP
--	-----	-------	-----	---	------	----

0h - Ah - BH1780GLI outputs Data from specified ADDRESS Field of Command Register until Master issues stop condition. Read cycle is Bh - Ch - Dh - 0h - Ah - Bh - Ch - Dh

ex) If ADDRESS Field of Command Register is Ch, then BH1780GLI outputs data like seeing in below.
Ch - Dh - 0h - Ah - Bh - Ch - Dh - 0h - Ah It is continued until Master issues stop condition.

●Caution of power on reset function

BH1780GLI has power on reset (POR) function. POR is to reset all register and flip flop when VCC Power supplies. There is some cautions about power on and down sequence seeing in below.

- ① Power on time : t1
More than 2ms is need to active BH1780GLI after VCC supplies more than 1.9V from VCC is less than 0.4V.
- ② Power off time : t2
More than 1ms (VCC < 0.4V) is need to active BH1780GLI.

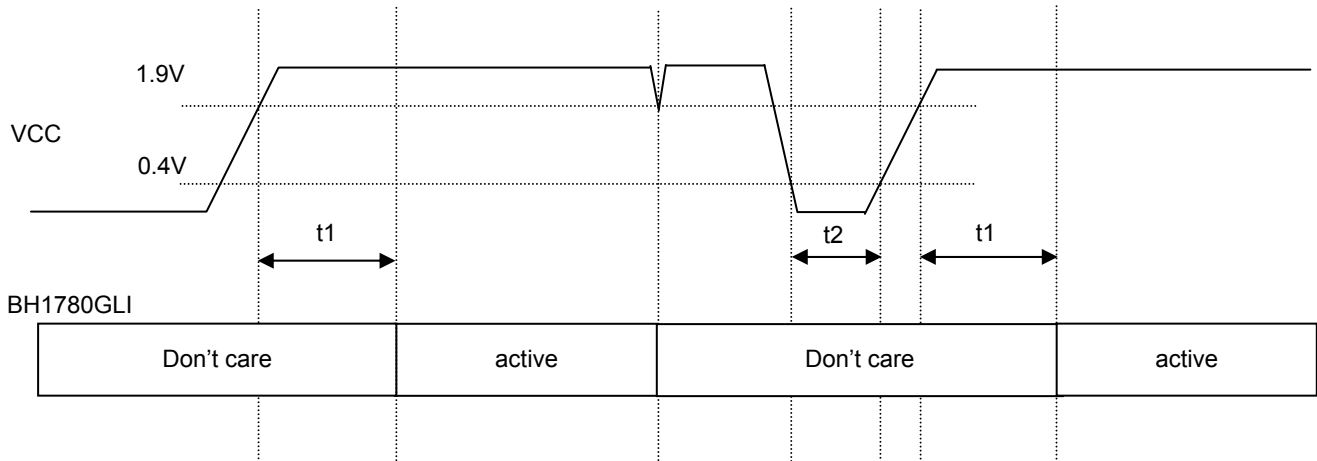

**"active state" is that BH1780GLI works and accept I²C bus access correctly.

●Terminal Description

PIN No.	Terminal Name	Equivalent Circuit	Function
1	VCC		Power Supply Terminal
2	GND		GND Terminal
3	SDA		I ² C bus Interface SDA Terminal
4	SCL		I ² C bus Interface SCL Terminal

●Package Outlines

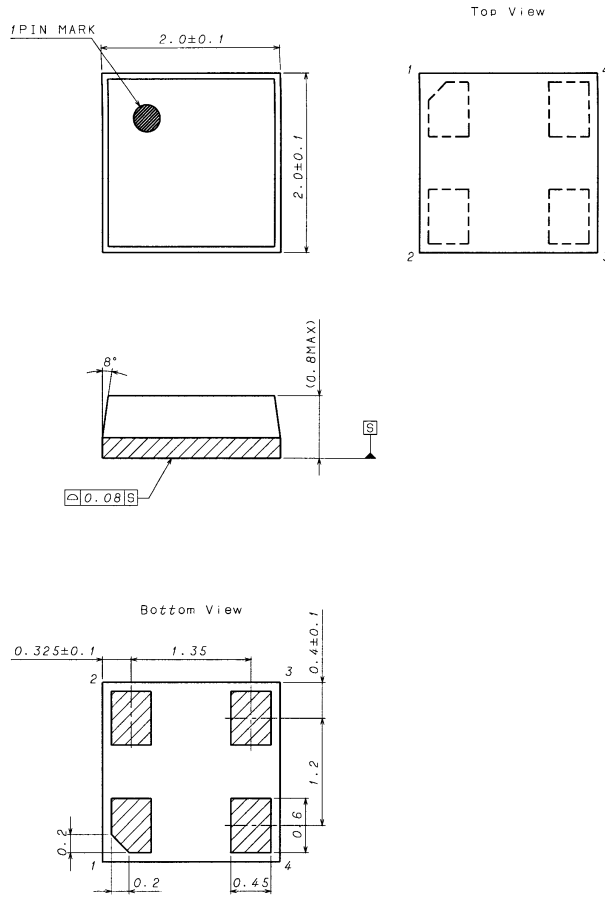

(UNIT: mm)

●Recommended Land pattern (Top view)

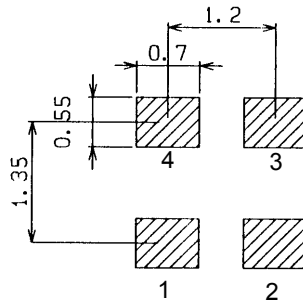

●Cautions on use

- 1) Absolute Maximum Ratings
An excess in the absolute maximum ratings, such as supply voltage (V_{max}), temperature range of operating conditions (T_{opr}), etc., can break down devices, thus making impossible to identify breaking mode such as a short circuit or an open circuit. If any special mode exceeding the absolute maximum ratings is assumed, consideration should be given to take physical safety measures including the use of fuses, etc.
- 2) GND voltage
Make setting of the potential of the GND terminal so that it will be maintained at the minimum in any operating state. Furthermore, check to be sure no terminals are at a potential lower than the GND voltage including an actual electric transient.
- 3) Short circuit between terminals and erroneous mounting
In order to mount ICs on a set PCB, pay thorough attention to the direction and offset of the ICs. Erroneous mounting can break down the ICs. Furthermore, if a short circuit occurs due to foreign matters entering between terminals or between the terminal and the power supply or the GND terminal, the ICs can break down.
- 4) Operation in strong electromagnetic field
Be noted that using ICs in the strong electromagnetic field can malfunction them.
- 5) Inspection with set PCB
On the inspection with the set PCB, if a capacitor is connected to a low-impedance IC terminal, the IC can suffer stress. Therefore, be sure to discharge from the set PCB by each process. Furthermore, in order to mount or dismount the set PCB to/from the jig for the inspection process, be sure to turn OFF the power supply and then mount the set PCB to the jig. After the completion of the inspection, be sure to turn OFF the power supply and then dismount it from the jig. In addition, for protection against static electricity, establish a ground for the assembly process and pay thorough attention to the transportation and the storage of the set PCB.
- 6) Input terminals
In terms of the construction of IC, parasitic elements are inevitably formed in relation to potential. The operation of the parasitic element can cause interference with circuit operation, thus resulting in a malfunction and then breakdown of the input terminal. Therefore, pay thorough attention not to handle the input terminals; such as to apply to the input terminals a voltage lower than the GND respectively, so that any parasitic element will operate.
- 7) Thermal design
Perform thermal design in which there are adequate margins by taking into account the power dissipation (P_d) in actual states of use.
- 8) Treatment of package
Dusts or scratch on the photo detector may affect the optical characteristics. Please handle it with care.
- 9) Rush current
When power is first supplied to the CMOS IC, it is possible that the internal logic may be unstable and rush current may flow instantaneously. Therefore, give special consideration to power coupling capacitance, power wiring, width of GND wiring, and routing of connections.

●Ordering part number



WLGA04IW02

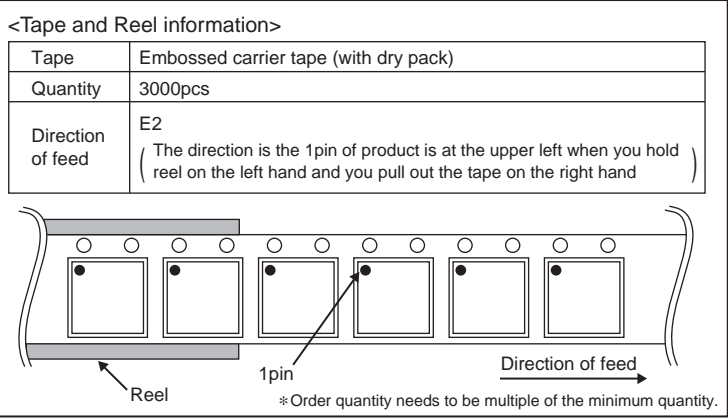
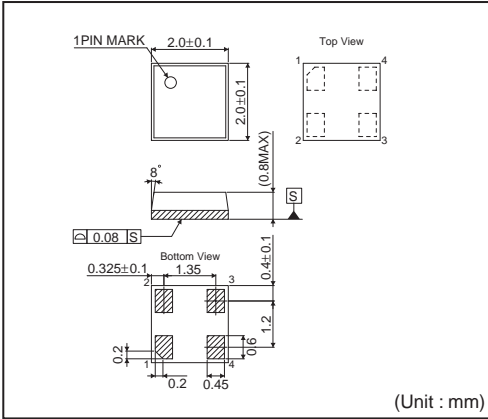

Notice

Precaution on using ROHM Products

- Our Products are designed and manufactured for application in ordinary electronic equipments (such as AV equipment, OA equipment, telecommunication equipment, home electronic appliances, amusement equipment, etc.). If you intend to use our Products in devices requiring extremely high reliability (such as medical equipment ^(Note 1), transport equipment, traffic equipment, aircraft/spacecraft, nuclear power controllers, fuel controllers, car equipment including car accessories, safety devices, etc.) and whose malfunction or failure may cause loss of human life, bodily injury or serious damage to property ("Specific Applications"), please consult with the ROHM sales representative in advance. Unless otherwise agreed in writing by ROHM in advance, ROHM shall not be in any way responsible or liable for any damages, expenses or losses incurred by you or third parties arising from the use of any ROHM's Products for Specific Applications.

(Note1) Medical Equipment Classification of the Specific Applications

JAPAN	USA	EU	CHINA
CLASS III	CLASS III	CLASS II b	CLASS III
CLASS IV		CLASS III	

- ROHM designs and manufactures its Products subject to strict quality control system. However, semiconductor products can fail or malfunction at a certain rate. Please be sure to implement, at your own responsibilities, adequate safety measures including but not limited to fail-safe design against the physical injury, damage to any property, which a failure or malfunction of our Products may cause. The following are examples of safety measures:
 - Installation of protection circuits or other protective devices to improve system safety
 - Installation of redundant circuits to reduce the impact of single or multiple circuit failure
- Our Products are designed and manufactured for use under standard conditions and not under any special or extraordinary environments or conditions, as exemplified below. Accordingly, ROHM shall not be in any way responsible or liable for any damages, expenses or losses arising from the use of any ROHM's Products under any special or extraordinary environments or conditions. If you intend to use our Products under any special or extraordinary environments or conditions (as exemplified below), your independent verification and confirmation of product performance, reliability, etc. prior to use, must be necessary:
 - Use of our Products in any types of liquid, including water, oils, chemicals, and organic solvents
 - Use of our Products outdoors or in places where the Products are exposed to direct sunlight or dust
 - Use of our Products in places where the Products are exposed to sea wind or corrosive gases, including Cl₂, H₂S, NH₃, SO₂, and NO₂
 - Use of our Products in places where the Products are exposed to static electricity or electromagnetic waves
 - Use of our Products in proximity to heat-producing components, plastic cords, or other flammable items
 - Sealing or coating our Products with resin or other coating materials
 - Use of our Products without cleaning residue of flux (even if you use no-clean type fluxes, cleaning residue of flux is recommended); or Washing our Products by using water or water-soluble cleaning agents for cleaning residue after soldering
 - Use of the Products in places subject to dew condensation
- The Products are not subject to radiation-proof design.
- Please verify and confirm characteristics of the final or mounted products in using the Products.
- In particular, if a transient load (a large amount of load applied in a short period of time, such as pulse. is applied, confirmation of performance characteristics after on-board mounting is strongly recommended. Avoid applying power exceeding normal rated power; exceeding the power rating under steady-state loading condition may negatively affect product performance and reliability.
- De-rate Power Dissipation (Pd) depending on Ambient temperature (Ta). When used in sealed area, confirm the actual ambient temperature.
- Confirm that operation temperature is within the specified range described in the product specification.
- ROHM shall not be in any way responsible or liable for failure induced under deviant condition from what is defined in this document.

Precaution for Mounting / Circuit board design

- When a highly active halogenous (chlorine, bromine, etc.) flux is used, the residue of flux may negatively affect product performance and reliability.
- In principle, the reflow soldering method must be used; if flow soldering method is preferred, please consult with the ROHM representative in advance.

For details, please refer to ROHM Mounting specification

Precautions Regarding Application Examples and External Circuits

1. If change is made to the constant of an external circuit, please allow a sufficient margin considering variations of the characteristics of the Products and external components, including transient characteristics, as well as static characteristics.
2. You agree that application notes, reference designs, and associated data and information contained in this document are presented only as guidance for Products use. Therefore, in case you use such information, you are solely responsible for it and you must exercise your own independent verification and judgment in the use of such information contained in this document. ROHM shall not be in any way responsible or liable for any damages, expenses or losses incurred by you or third parties arising from the use of such information.

Precaution for Electrostatic

This Product is electrostatic sensitive product, which may be damaged due to electrostatic discharge. Please take proper caution in your manufacturing process and storage so that voltage exceeding the Products maximum rating will not be applied to Products. Please take special care under dry condition (e.g. Grounding of human body / equipment / solder iron, isolation from charged objects, setting of ionizer, friction prevention and temperature / humidity control).

Precaution for Storage / Transportation

1. Product performance and soldered connections may deteriorate if the Products are stored in the places where:
 - [a] the Products are exposed to sea winds or corrosive gases, including Cl₂, H₂S, NH₃, SO₂, and NO₂
 - [b] the temperature or humidity exceeds those recommended by ROHM
 - [c] the Products are exposed to direct sunshine or condensation
 - [d] the Products are exposed to high Electrostatic
2. Even under ROHM recommended storage condition, solderability of products out of recommended storage time period may be degraded. It is strongly recommended to confirm solderability before using Products of which storage time is exceeding the recommended storage time period.
3. Store / transport cartons in the correct direction, which is indicated on a carton with a symbol. Otherwise bent leads may occur due to excessive stress applied when dropping of a carton.
4. Use Products within the specified time after opening a humidity barrier bag. Baking is required before using Products of which storage time is exceeding the recommended storage time period.

Precaution for Product Label

QR code printed on ROHM Products label is for ROHM's internal use only.

Precaution for Disposition

When disposing Products please dispose them properly using an authorized industry waste company.

Precaution for Foreign Exchange and Foreign Trade act

Since our Products might fall under controlled goods prescribed by the applicable foreign exchange and foreign trade act, please consult with ROHM representative in case of export.

Precaution Regarding Intellectual Property Rights

1. All information and data including but not limited to application example contained in this document is for reference only. ROHM does not warrant that foregoing information or data will not infringe any intellectual property rights or any other rights of any third party regarding such information or data. ROHM shall not be in any way responsible or liable for infringement of any intellectual property rights or other damages arising from use of such information or data.:
2. No license, expressly or implied, is granted hereby under any intellectual property rights or other rights of ROHM or any third parties with respect to the information contained in this document.

Other Precaution

1. This document may not be reprinted or reproduced, in whole or in part, without prior written consent of ROHM.
2. The Products may not be disassembled, converted, modified, reproduced or otherwise changed without prior written consent of ROHM.
3. In no event shall you use in any way whatsoever the Products and the related technical information contained in the Products or this document for any military purposes, including but not limited to, the development of mass-destruction weapons.
4. The proper names of companies or products described in this document are trademarks or registered trademarks of ROHM, its affiliated companies or third parties.

General Precaution

1. Before you use our Products, you are requested to carefully read this document and fully understand its contents. ROHM shall not be in any way responsible or liable for failure, malfunction or accident arising from the use of any ROHM's Products against warning, caution or note contained in this document.
2. All information contained in this document is current as of the issuing date and subject to change without any prior notice. Before purchasing or using ROHM's Products, please confirm the latest information with a ROHM sales representative.
3. The information contained in this document is provided on an "as is" basis and ROHM does not warrant that all information contained in this document is accurate and/or error-free. ROHM shall not be in any way responsible or liable for any damages, expenses or losses incurred by you or third parties resulting from inaccuracy or errors of or concerning such information.

X-ON Electronics

Largest Supplier of Electrical and Electronic Components

Click to view similar products for [Ambient Light Sensors](#) category:

Click to view products by [ROHM](#) manufacturer:

Other Similar products are found below :

[IS31SE5000-UTLS2-TR](#) [0805-PTSM D021](#) [ALS-PT19-315C/L177/TR8](#) [BH1680FVC-TR](#) [SI1132-A10-GM](#) [APS3227SP1C-P22](#) [ALS-PDIC144-6C/L378](#) [4681](#) [AS7211-BLGM](#) [AS7211-BLGT](#) [AS7220-BLGM](#) [AS7221-BLGM](#) [AS7263-BLGM](#) [AS7341-DLGM](#) [AS7341-DLGT](#) [TMD27253M](#) [TMD27504](#) [TMD37024VCM](#) [TMD37253M](#) [TSL25403M](#) [TSL27403M](#) [APDS-9007-020](#) [DY-FPD204-6B/L3](#) [DY-FPD333-3B/L3](#) [DY-FPD333B-A5](#) [DY-FPD4134C-A3](#) [DY-PD204-6B](#) [DY-PD234-6B](#) [DY-PD333B-A5](#) [DY-PD673B-A2](#) [CLS15-22C/L213G/TR8](#) [HLPT5I850HP25](#) [ISL76671AR0Z-T7A](#) [LTR-303ALS-01](#) [LTR-329ALS-01](#) [LTR-308ALS-01](#) [NJL7502L](#) [LV0111CF-TLM-H](#) [SFH 3711](#) [BH1600FVC-TR](#) [BH1603FVC-TR](#) [BH1620FVC-TR](#) [BH1621FVC-TR](#) [BH1710FVC-TR](#) [BH1721FVC-TR](#) [BH1730FVC-TR](#) [BH1749NUC-E2](#) [BH1750FVI-TR](#) [BH1751FVI-TR](#) [RPR-0521RS](#)