

CMOS LDO Regulators for Potable Equipments

System Regulator with High Efficiency DC/DC Converters



BH6172GU

No.11020EAT08

●Descriptions

BH6172GU incorporates 1 DCDC+ 5 Linear LDO regulators. It is integrated in a small 2.6mm×2.6mm size package, with 16 steps adjustable Vo's for every channel, low voltage output (0.8V~) to support almost any kind of mobile application now available.

●Features

- 1) 1ch 500mA, high efficiency Step-down Converter. (16 steps adjustable VO by I²C)
- 2) 5-channel CMOS-type LDOs. (16 steps adjustable VO by I²C, 150mA × 3, 300mA × 2)
- 3) Power ON/OFF control enabled by I2C interface or external pin
- 4) I²C compatible Interface. (Device address is "1001111")
- 5) Wafer Level CSP package(2.6mm × 2.6mm) for space-constrained applications
- 6) Discharge resistance selectable for power-down sequence ramp speed control
- 7) Over-current protection in all LDO regulators
- 8) Over-current protection in Step-down Converter
- 9) Over-voltage protection in Step-down Converter
- 10) Thermal shutdown protection

●Applications

Mobile phones, Portable game systems, Portable mp3 players, Portable DVD players, Portable TV, Portable GPS, PDA, Portable electronic dictionaries, etc.

●Absolute maximum ratings (Ta=25°C)

Parameter	Symbol	Ratings	Unit
Maximum Supply Voltage (VBAT)	VBATMAX	6.0	V
Maximum Supply Voltage (PBAT)	VPBATMAX	6.0	V
Maximum Supply Voltage (VUSB)	VUSBMAX	6.0	V
Maximum Supply Voltage (DVDD)	DVDDMAX	4.5	V
Maximum Input Voltage 1 (LX, FB, OUT1, OUT2, OUT3, OUT4, OUT5, EN_LD1, EN_LD2, EN_LD3, EN_LD4)	VINMAX1	VBAT + 0.3	V
Maximum Input Voltage 2 (NRST, CLK, DATA)	VINMAX2	DVDD + 0.3	V
Power Dissipation	Pd	900* ¹	mW
Operating Temperature Range	Topr	-35 ~ +85	°C
Storage Temperature Range	Tstg	-55 ~ +125	°C

* This is an allowable loss of the ROHM evaluation glass epoxy board(60mm × 60mm × 16mm).
To use at temperature higher than 25°C, derate 9.0mW per 1°C.

*1 Must not exceed Pd or ASO.

● Recommended Operating Conditions (Ta=25°C)

Parameter	Symbol	Ratings	Unit
VBAT Voltage	VBAT	2.20 ~ 5.50* ²	V
PBAT Voltage	VPBAT	2.20 ~ 5.50* ²	V
VUSB Voltage	VUSB	2.20 ~ 5.50* ^{2*3}	V
DVDD Voltage	VDVDD	1.70 ~ 4.20* ⁴	V

*² Whenever the VBAT or PBAT or VUSB voltage is under the LDO, SWREG output voltage, or else under certain levels, the LDO and SWREG output is not guaranteed to meet its published specifications.

*³ VUSB Power Supply can be externally connected to the VBAT, PBAT Power Supply when necessary.

*⁴ The DVDD Voltage must be under the Battery Voltage VBAT, PBAT at any times.

● Electrical Characteristics (Unless otherwise specified, Ta=25°C, VBAT=PBAT =3.6V, VUSB=5.0V)

Parameter	Symbol	Limits			Unit	Condition
		Min.	Typ.	Max.		
Circuit Current						
VBAT Circuit Current 1 (OFF)	IQVB1	-	0.4	1	μA	LDO1~5=OFF SWREG1=OFF NRST=L DVDD=0V
VUSB Circuit Current 1 (OFF)	IQUSB1	-	0	1	μA	LDO1~5=OFF SWREG1=OFF NRST=L DVDD=0V
VBAT Circuit Current 2 (OFF)	IQVB2	-	0.4	1	μA	LDO1~5=OFF SWREG1=OFF NRST=L DVDD=0V VUSB=VBAT external connection
VBAT Circuit Current 3 (STANDBY)	IQVB3	-	0.7	1.4	μA	LDO1~5=OFF SWREG1=OFF NRST=H DVDD=2.6V
VUSB Circuit Current 2 (STANDBY)	IQUSB2	-	0	1	μA	LDO1~5=OFF SWREG1=OFF NRST=H DVDD=2.6V
VBAT Circuit Current 4 (STANDBY)	IQVB4	-	0.7	1.4	μA	LDO1~5=OFF SWREG1=OFF NRST=H DVDD=2.6V VUSB=VBAT external connection
VBAT Circuit Current 5 (Active)	IQVB5	-	170	300	μA	LDO1~5=ON(no load, initial voltage) SWREG1=ON(no load, initial voltage) NRST=H DVDD=2.6V
VUSB Circuit Current 3 (Active)	IQUSB3	-	35	70	μA	LDO1~5=ON(no load, initial voltage) SWREG1=ON(no load, initial voltage) NRST=H DVDD=2.6V
VBAT Circuit Current 6 (Active)	IQVB6	-	200	350	μA	LDO1~5=ON(no load, initial voltage) SWREG1=ON(no load, initial voltage) NRST=H DVDD=2.6V VUSB=VBAT external connection

©This product is not especially designed to be protected from radioactivity.

● **Electrical Characteristics** (Unless otherwise specified, Ta=25°C, VBAT=PBAT =3.6V, VUSB=5.0V, DVDD=2.6V)

Parameter		Symbol	Limits			Unit	Condition
			Min.	Typ.	Max.		
Logic pin character							
NRST (CMOS input)	Input "H" level	VIH1	DVDD x0.7	-	DVDD +0.3	V	Pin voltage: DVDD
	Input "L" level	VIL1	-0.3	-	DVDD x0.3	V	Pin voltage: 0 V
	Input leak current	IIC1	0	0.3	1	μA	
EN_LD1, EN_LD2, EN_LD3, EN_LD4 (NMOS input)	Input "H" level	VIH2	1.44	-	-	V	
	Input "L" level	VIL2	-	-	0.4	V	
	Input leak current	IIC2	-1	0	1	μA	
Digital characteristics (Digital pins: CLK and DATA)							
Input "H" level	VIH3	DVDD x0.8	-	DVDD +0.3	V		
Input "L" level	VIL3	-0.3	-	DVDD x0.2	V		
Input leak current	IIC3	-1	0	1	μA	Pin voltage: DVDD	
DATA output "L" level voltage	VOL	-	-	0.4	V	IOL=6mA	
SWREG							
Output Voltage	VOSW	0.94	1.00	1.06	V	initial value Io=100mA	
Output current	IOSW	-	-	500	mA	Vo=1.00V	
Efficiency	η_{SW}	-	90	-	%	Io=100mA, Vo=2.40V, VBAT=3.2V	
Oscillating Frequency	fOSC	-	1.7	-	MHz	Vo=1.00V	
Output Inductance	LSWREG	1.5	2.2	-	μH	Ta= -30~75°C	
Short circuit current	ISHTSW	-	500	-	mA	Ta= -30~75°C	
Output Capacitance	CSWREG	3.3	4.7	-	μF	Ta= -30~75°C with SWREG's DC bias	

● **Electrical Characteristics** (Unless otherwise specified, Ta=25°C, VBAT=PBAT =3.6V, VUSB=5.0V)

Parameter	Symbol	Limits			Unit	Condition
		Min.	Typ.	Max.		
LDO1						
Output Voltage	VOM1	0.970	1.000	1.030	V	initial value Io=1mA@VBAT=4.5V Io=150mA@VBAT=3.4V
Output current	VOM1C	-	-	150	mA	Vo=1.0V
Dropout Voltage	VOM1DP	-	0.1	-	V	Io=50mA
Input Voltage Stability	Δ VIM1	-	2	-	mV	VBAT=3.4~4.5V, Io=50mA Vo=1.0V
Load Stability	Δ VLM1	-	20	-	mV	Io=50 μ A~150mA, VBAT=3.6V Vo=1.0V
Ripple rejection ratio	RRM1	-	60	-	dB	VR=-20dBV, fR=120Hz Io=50mA, Vo=2.6V BW=20Hz~20kHz
Short circuit current	ISHTM3	-	180	-	mA	Vo=0V
Output Capacitor	COUT1	-	1.0	-	μ F	Ta= -30~75°C with LDO's DC bias
LDO2						
Output Voltage	VOM2	2.522	2.600	2.678	V	initial value Io=1mA@VBAT=4.5V Io=150mA@VBAT=3.4V
Output current	VOM2C	-	-	150	mA	Vo=2.6V
Dropout Voltage	VOM2DP	-	0.1	-	V	Io=50mA
Input Voltage Stability	Δ VIM2	-	2	-	mV	VBAT=3.4~4.5V, Io=50mA Vo=2.6V
Load Stability	Δ VLM2	-	20	-	mV	Io=50 μ A~150mA, VBAT=3.6V Vo=2.6V
Ripple rejection ratio	RRM2	-	60	-	dB	VR=-20dBV, fR=120Hz Io=50mA, Vo=2.6V BW=20Hz~20kHz
Short circuit current	ISHTM3	-	180	-	mA	Vo=0V
Output Capacitor	COUT2	-	1.0	-	μ F	Ta= -30~75°C with LDO's DC bias
LDO3						
Output Voltage	VOM3	2.716	2.800	2.884	V	initial value Io=1mA@VBAT=4.5V Io=150mA@VBAT=3.4V
Output current	VOM3C	-	-	300	mA	Vo=2.8V
Dropout Voltage	VOM3DP	-	0.1	-	V	Io=50mA
Input Voltage Stability	Δ VIM3	-	2	-	mV	VBAT=3.4~4.5V, Io=50mA Vo=2.8V
Load Stability	Δ VLM3	-	20	-	mV	Io=50 μ A~300mA, VBAT=3.6V Vo=2.8V
Ripple rejection ratio	RRM3	-	60	-	dB	VR=-20dBV, fR=120Hz Io=50mA, Vo=2.6V BW=20Hz~20kHz
Short circuit current	ISHTM3	-	180	-	mA	Vo=0V
Output Capacitor	COUT3	-	1.0	-	μ F	Ta= -30~75°C with LDO's DC bias

●Electrical Characteristics (Unless otherwise specified, Ta=25°C, VBAT=PBAT =3.6V, VUSB=5.0V)

Parameter	Symbol	Limits			Unit	Condition
		Min.	Typ.	Max.		
LDO4						
Output Voltage	VOM4	1.746	1.800	1.854	V	initial value Io=1mA@VBAT=4.5V Io=300mA@VBAT=3.4V
Output current	VOM4C	-	-	300	mA	Vo=1.8V
Dropout Voltage	VOM4DP	-	0.1	-	V	Io=50mA
Input Voltage Stability	Δ VIM4	-	2	-	mV	VBAT=3.4~4.5V, Io=50mA Vo=1.8V
Load Stability	Δ VLM4	-	30	-	mV	Io=50 μ A~300mA, VBAT=3.6V Vo=1.8V
Ripple rejection ratio	RRM4	-	60	-	dB	VR=-20dBV, fR=120Hz Io=50mA, Vo=2.6V BW=20Hz~20kHz
Short circuit current	ISHTM4	-	340	-	mA	Vo=0V
Output Capacitor	COUT4	-	1.0	-	μ F	Ta= -30~75°C with LDO's DC bias
LDO5						
Output Voltage	VOM5	3.201	3.300	3.399	V	initial value Io=1mA@VUSB=5.5V Io=150mA@VUSB=4.4V
Output current	VOM5C	-	-	150	mA	Vo=3.3V
Dropout Voltage	VOM5DP	-	0.1	-	V	Io=50mA
Input Voltage Stability	Δ VIM5	-	2	-	mV	VUSB=4.4~5.5V, Io=50mA Vo=3.3V
Load Stability	Δ VLM5	-	20	-	mV	Io=50 μ A~150mA, VUSB=5.5V Vo=3.3V
Ripple rejection ratio	RRM5	-	60	-	dB	VR=-20dBV, fR=120Hz Io=50mA, Vo=2.6V BW=20Hz~20kHz
Short circuit current	ISHTM5	-	180	-	mA	Vo=0V
Output Capacitor	COUT5	-	1.0	-	μ F	Ta= -30~75°C with LDO's DC bias

●SWREG & LDOs Output Voltage table

Parameter	Usage example	Power Supply	Initial Output Voltage	Load max	Adjustable range
SWREG	CORE	VBAT/PBAT	1.00V	500mA	0.80-2.40V
LDO1	CORE	VBAT	1.00V	150mA	1.00-3.30V
LDO2	I/O1	VBAT	2.60V	150mA	1.00-3.30V
LDO3	MEMORY	VBAT	2.80V	300mA	1.20-3.30V
LDO4	I/O2	VBAT	1.80V	300mA	1.20-3.30V
LDO5	USB	VBAT/VUSB	3.30V	150mA	1.20-3.30V

Parameter	SWREG	LDO1	LDO2	LDO3	LDO4	LDO5
Programmable Output Voltages	0.80V	1.00V	1.00V	1.20V	1.20V	1.20V
	0.85V	1.10V	1.10V	1.30V	1.30V	1.30V
	0.90V	1.20V	1.20V	1.40V	1.40V	1.40V
	0.95V	1.30V	1.30V	1.50V	1.50V	1.50V
	1.00V	1.40V	1.40V	1.60V	1.60V	1.60V
	1.05V	1.50V	1.50V	1.70V	1.70V	1.70V
	1.10V	1.60V	1.60V	1.80V	1.80V	1.80V
	1.15V	1.70V	1.70V	1.85V	1.85V	1.85V
	1.20V	1.80V	1.80V	1.90V	1.90V	1.90V
	1.365V	1.85V	1.85V	2.00V	2.00V	2.00V
	1.40V	2.60V	2.60V	2.60V	2.60V	2.60V
	1.50V	2.70V	2.70V	2.70V	2.70V	2.70V
	1.65V	2.80V	2.80V	2.80V	2.80V	2.80V
	1.80V	2.85V	2.85V	2.85V	2.85V	2.85V
	1.85V	3.00V	3.00V	3.00V	3.00V	3.00V
	2.40V	3.30V	3.30V	3.30V	3.30V	3.30V

●Block diagram, Ball matrix

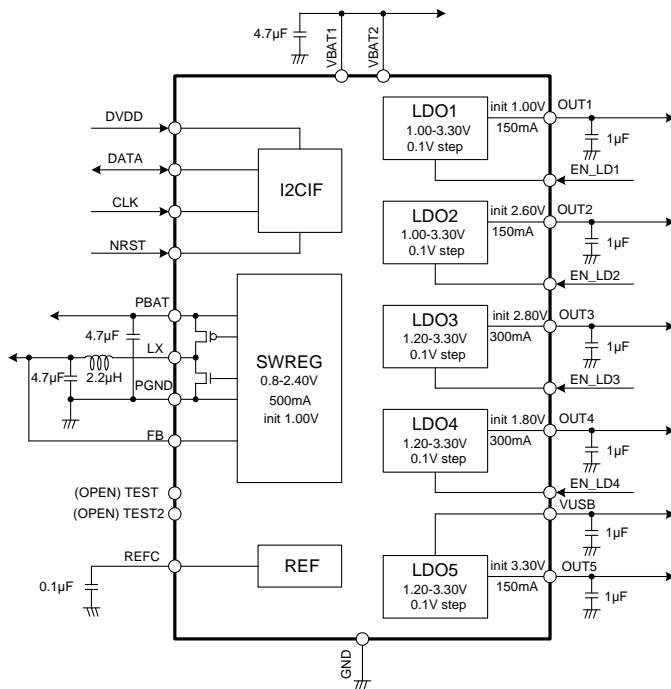

Fig.1 Block diagram

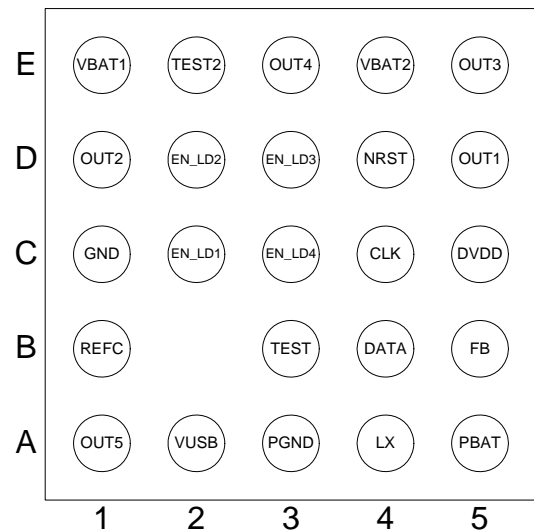

Fig.2 Ball matrix

●Pin description

Ball No.	PIN Name	Function
B4	DATA	Data input/output for I ² C
C4	CLK	CLK input for I ² C
E1	VBAT1	Power Supply 1
E4	VBAT2	Power Supply 2
A5	PBAT	Power Supply for SWREG
A4	LX	Inductor Connect pin for SWREG
A3	PGND	Ground for SWREG
B5	FB	Voltage Feed back pin for SWREG
D4	NRST	RESET Input Pin (Low Active)
D5	OUT1	LDO1 Output
D1	OUT2	LDO2 Output
E5	OUT3	LDO3 Output
E3	OUT4	LDO4 Output
A1	OUT5	LDO5 Output
B1	REFC	Reference Voltage Output
C2	EN_LD1	LDO1 Enable Pin
D2	EN_LD2	LDO2 Enable Pin
D3	EN_LD3	LDO3 Enable Pin
C3	EN_LD4	LDO4 Enable Pin
A2	VUSB	USBVBUS Power Supply ^{*1}
C5	DVDD	Digital Power Supply
C1	GND	Analog Ground
B3	TEST	TEST PIN (Always keep OPEN at normal use)
E2	TEST2	TEST PIN (Always keep OPEN at normal use)

* EST, TEST2 pin is used during our company shipment test.
Please keep TEST pin and TEST2 pin "OPEN" at all times.

^{*1} USB Power Supply can be externally connected to the VBAT Power Supply when necessary.

● I²C Bus Interface

The I²C compatible synchronous serial interface provides access to programmable functions and register on the device. This protocol uses a two-wire interface for bi-directional communications between the LSI's connected to the bus. The two interface lines are the Serial Data Line (DATA), and the Serial Clock Line (CLK). These lines should be connected to the power supply DVDD by a pull-up resistor, and remain high even when the bus is idle.

1. Start and Stop Conditions

When CLK is high, pulling DATA low produces a start condition and pulling DATA high produces a stop condition. Every instruction is started when a start condition occurs and terminated when a stop condition occurs. During read, a stop condition causes the read to terminate and the chip enters the standby state. During write, a stop condition causes the fetching of write data to terminate, after which writing starts automatically. Upon the completion of writing, the chip enters the standby state. Two or more start conditions cannot be entered consecutively.

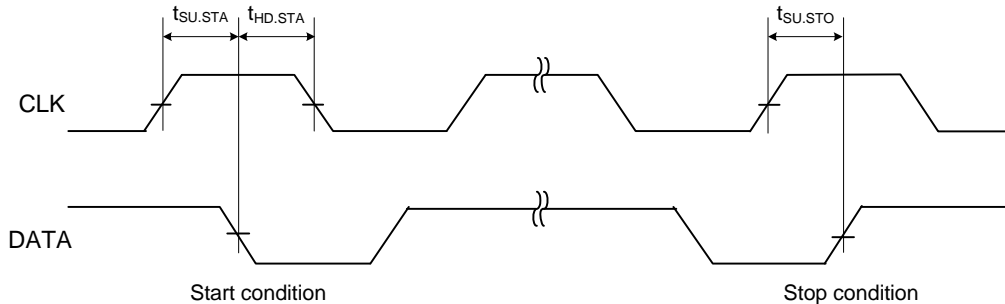

Fig.3 I²C Start, Stop condition

2. Data transmission

Data on the DATA input can be modified while CLK is low. When CLK is high, modifying the DATA input means a start or stop condition.

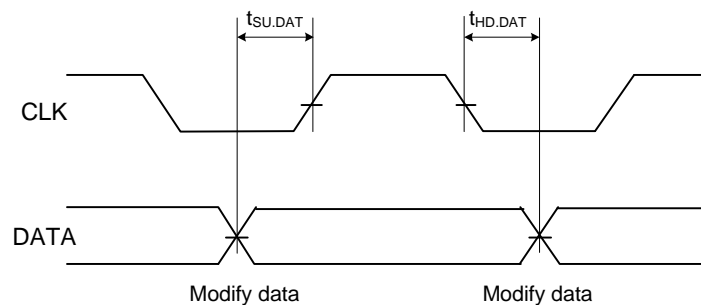

Fig.4 I²C Data Transmission Timing

All other acknowledge, write, and read timings all conform to the I²C standard.

3. Device addressing

The device address for this device is "1001111".

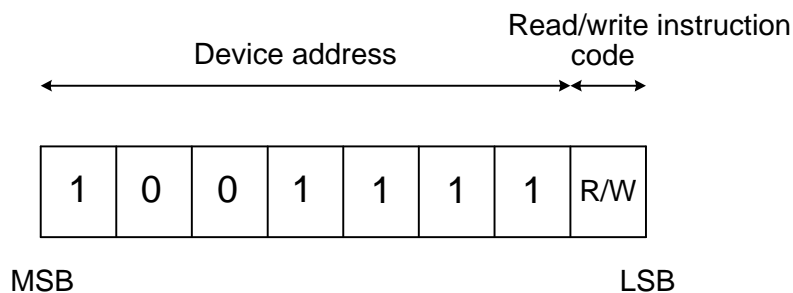

Fig.5 I²C device address

● I²C Bus AC specification

Characteristics	Symbol	Min.	Max.	Unit
CLK clock frequency	fCLK	0	400	kHz
CLK clock "low" time	tLOW	1.3	-	μs
CLK clock "high" time	tHIGH	0.6	-	μs
Bus free time	tBUF	1.3	-	μs
Start condition hold time	tHD.STA	0.6	-	μs
Start condition setup time	tSU.STA	0.6	-	μs
Data input hold time	tHD.DAT	0	-	ns
Data input setup time	tSU.DAT	100	-	ns
Stop condition setup time	tSU.STO	0.6	-	μs

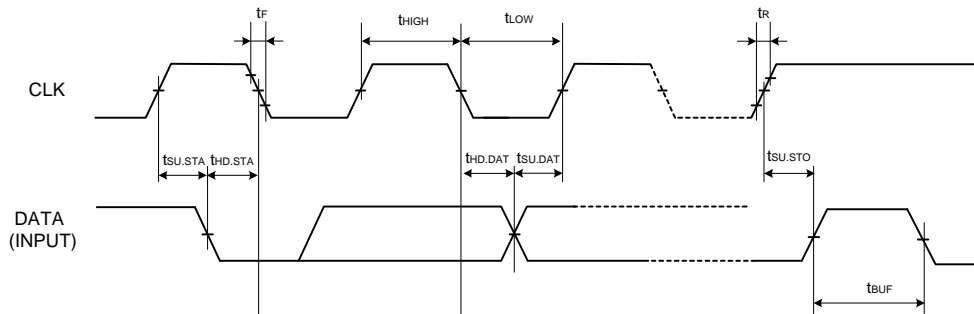

Fig.6 Bus timing 1

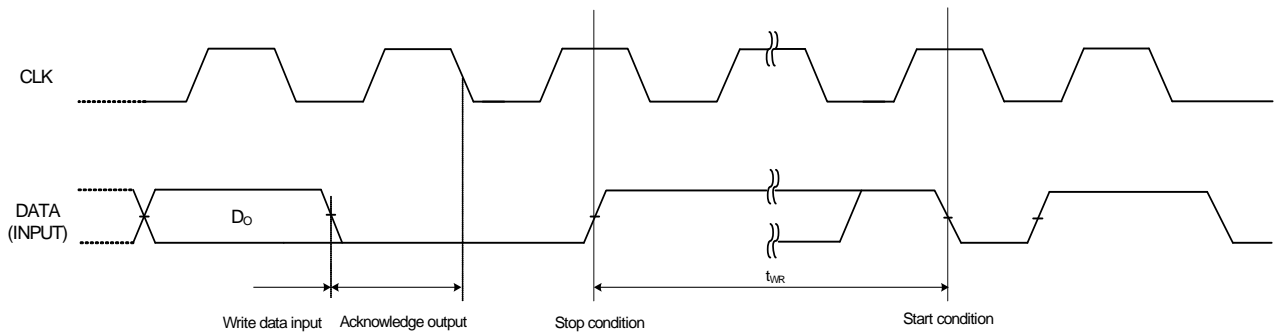

Fig.7 Bus timing 2

● I²C Register information

OREGCNT(SWREGON, LDO*ON)

Control each SWREG, LDO.

0	ON
1	OFF

OSWADJ(SWREGADJ[3:0])

Change SWREG output voltage by 16 steps.

"0000"	0.80V
∟	∟
"1111"	2.40V

OLDLOADJ*(LDO*ADJ[3:0])

Change LDO1~5 output voltage by 16 steps.

"0000"	1.00V(LDO1, 2), 1.20V(LDO3, 4, 5)
∟	∟
"1111"	3.30V

OPDSEL(SWPDSEL, LDO*PDSEL)

Change the discharge resistance of SWREG, LDO.

0	1kΩ
1	10kΩ

OPDCNT(SWPD, LDO*PD)

Enable/disable the discharge resistance of SWREG, LDO.

0	Discharge disable
1	Discharge enable

OEN_SEL(ENLD*_EN)

Select either an enable pin or I²C register for LDO1~4 ON/OFF control.

0	External enable pin selected
1	I ² C register selected

●Reference data(ICC)

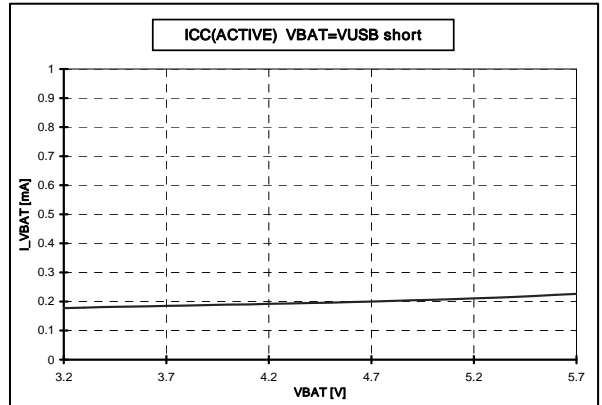
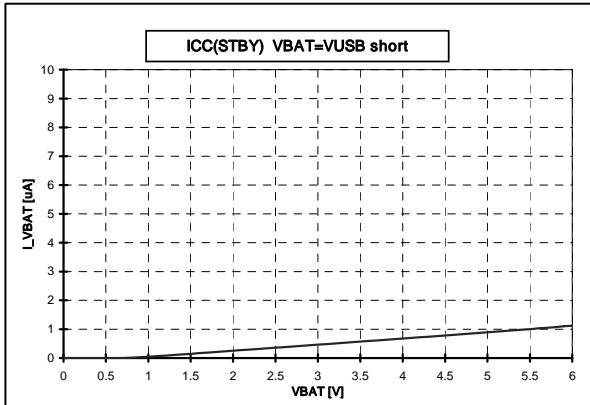
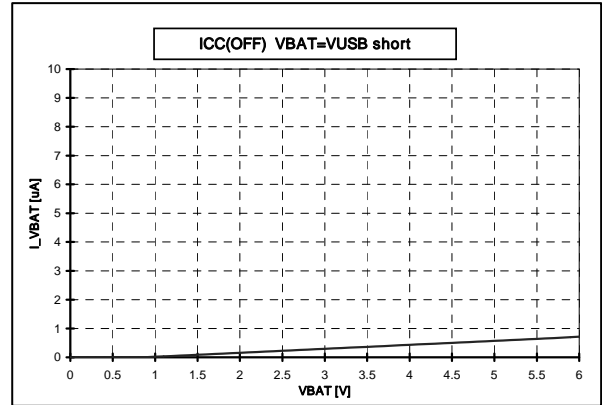
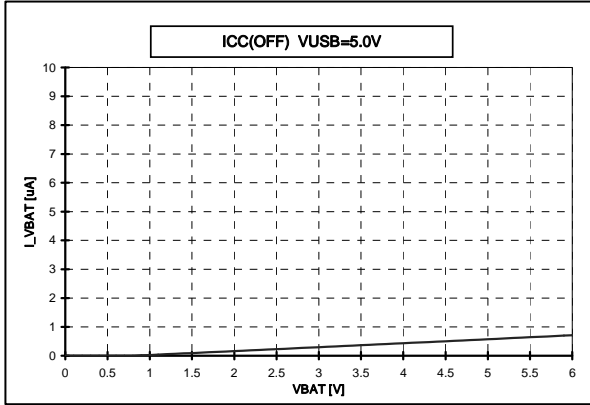

●Reference data(SWREG)

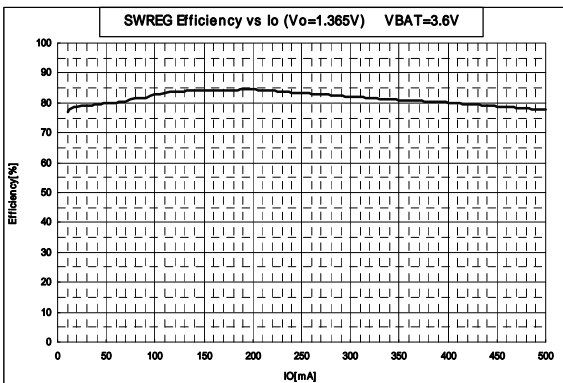
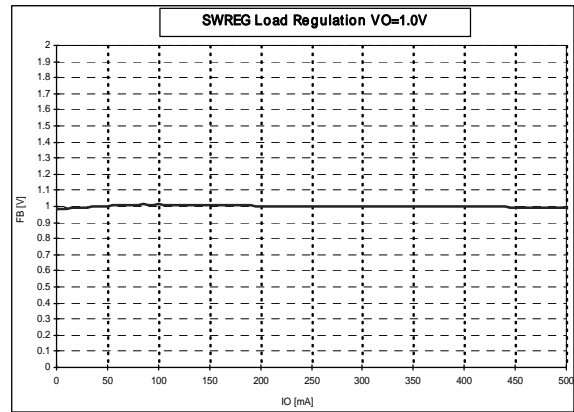
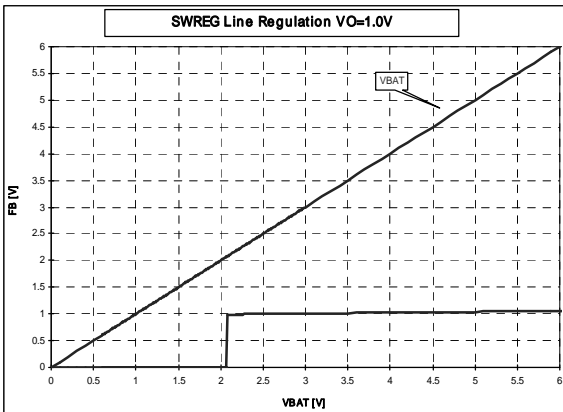

●Reference data(Output stability)

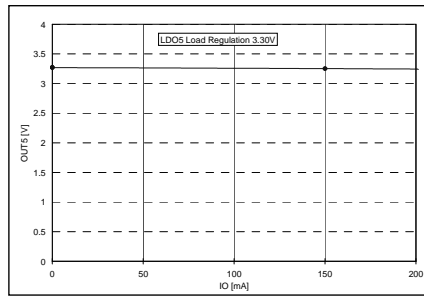
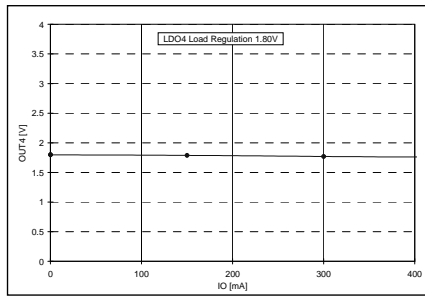
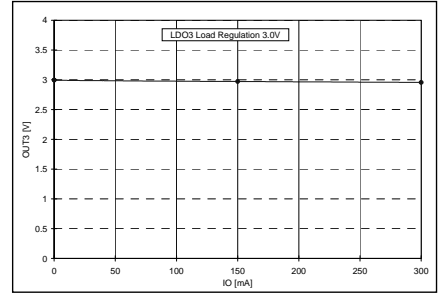
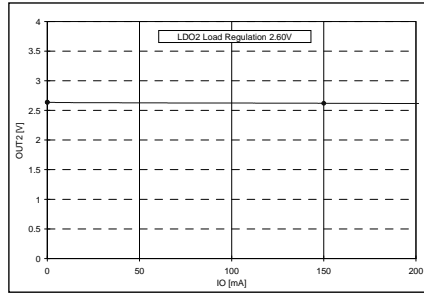
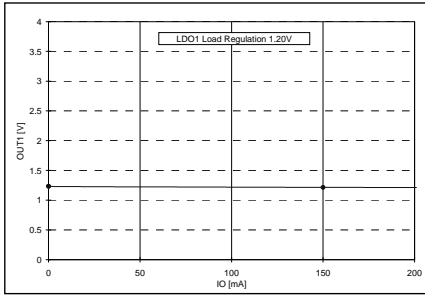

●Reference data(Input stability)

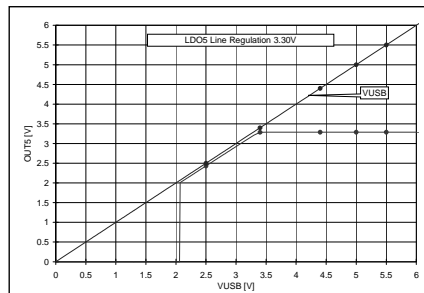
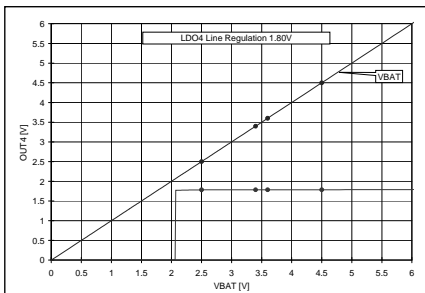
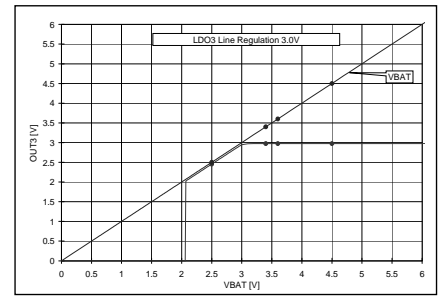
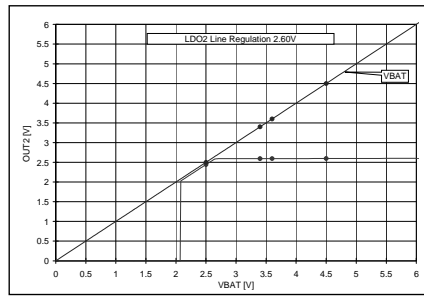
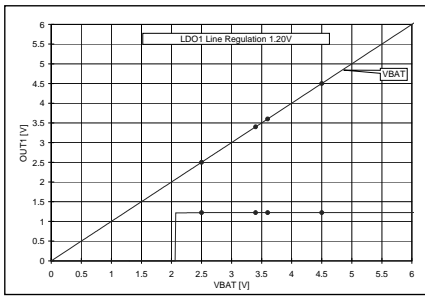

●Reference data(Load transient response)

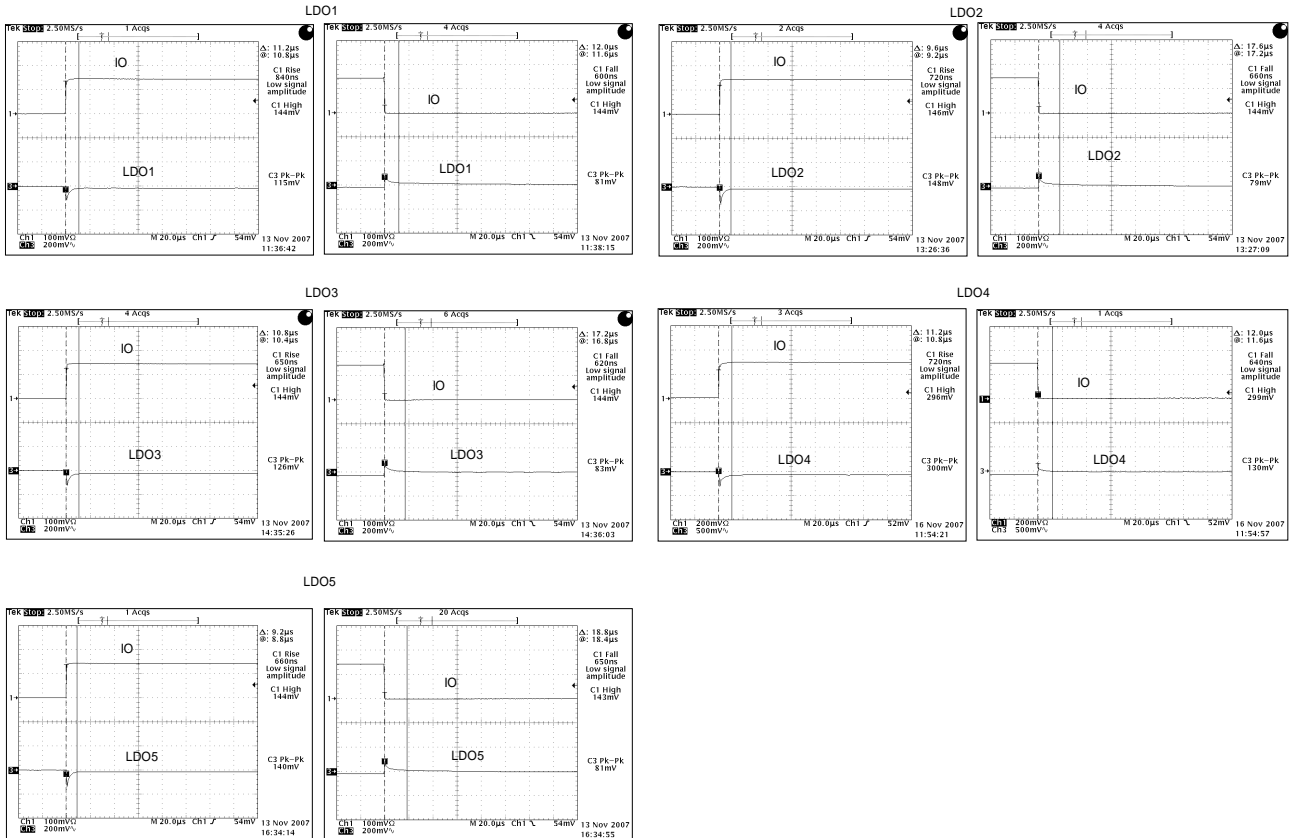

●Reference data(Rise time)

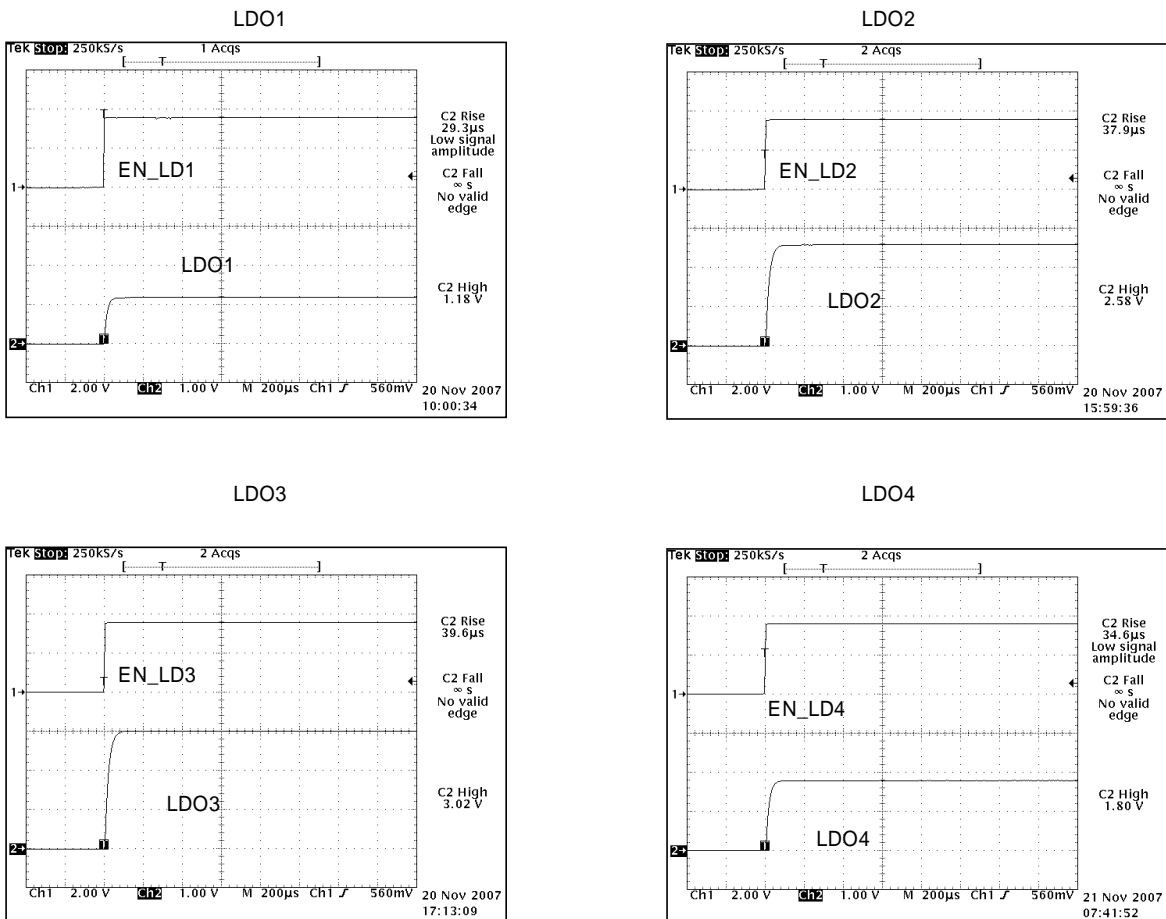

●Reference data(VBAT line transient response)

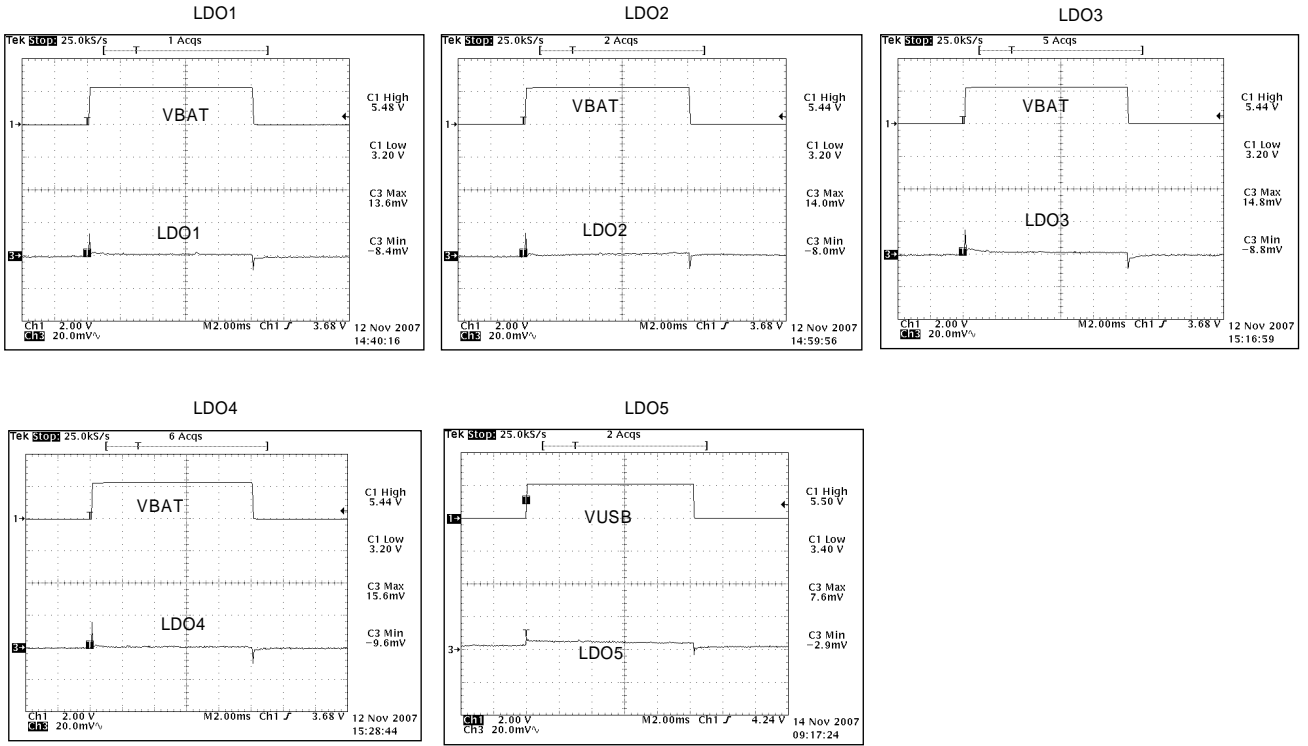

●Notes for use

- (1) Absolute maximum ratings
If applied voltage (VBAT, VADP, VUSB), operating temperature range (Topr), or other absolute maximum ratings are exceeded, there is a risk of damage. Since it is not possible to identify short, open, or other damage modes, if special modes in which absolute maximum ratings are exceeded are assumed, consider applying fuses or other physical safety measures.
- (2) Recommended operating range
This is the range within which it is possible to obtain roughly the expected characteristics. For electrical characteristics, it is those that are guaranteed under the conditions for each parameter. Even when these are within the recommended operating range, voltage and temperature characteristics are indicated.
- (3) Reverse connection of power supply connector
There is a risk of damaging the LSI by reverse connection of the power supply connector. For protection from reverse connection, take measures such as externally placing a diode between the power supply and the power supply pin of the LSI.
- (4) Power supply lines
In the design of the board pattern, make power supply and GND line wiring low impedance. When doing so, although the digital power supply and analog power supply are the same potential, separate the digital power supply pattern and analog power supply pattern to deter digital noise from entering the analog power supply due to the common impedance of the wiring patterns. Similarly take pattern design into account for GND lines as well. Furthermore, for all power supply pins of the LSI, in conjunction with inserting capacitors between power supply and GND pins, when using electrolytic capacitors, determine constants upon adequately confirming that capacitance loss occurring at low temperatures is not a problem for various characteristics of the capacitors used.
- (5) GND voltage
Make the potential of a GND pin such that it will be the lowest potential even if operating below that. In addition, confirm that there are no pins for which the potential becomes less than a GND by actually including transition phenomena.
- (6) Shorts between pins and misinstallation
When installing in the set board, pay adequate attention to orientation and placement discrepancies of the LSI. If it is installed erroneously, there is a risk of LSI damage. There also is a risk of damage if it is shorted by a foreign substance getting between pins or between a pin and a power supply or GND.
- (7) Operation in strong magnetic fields
Be careful when using the LSI in a strong magnetic field, since it may malfunction.
- (8) Inspection in set board
When inspecting the LSI in the set board, since there is a risk of stress to the LSI when capacitors are connected to low impedance LSI pins, be sure to discharge for each process. Moreover, when getting it on and off of a jig in the inspection process, always connect it after turning off the power supply, perform the inspection, and remove it after turning off the power supply. Furthermore, as countermeasures against static electricity, use grounding in the assembly process and take appropriate care in transport and storage.
- (9) Input pins
Parasitic elements inevitably are formed on an LSI structure due to potential relationships. Because parasitic elements operate, they give rise to interference with circuit operation and may be the cause of malfunctions as well as damage. Accordingly, take care not to apply a lower voltage than GND to an input pin or use the LSI in other ways such that parasitic elements operate. Moreover, do not apply a voltage to an input pin when the power supply voltage is not being applied to the LSI. Furthermore, when the power supply voltage is being applied, make each input pin a voltage less than the power supply voltage as well as within the guaranteed values of electrical characteristics.
- (10) Ground wiring pattern
When there is a small signal GND and a large current GND, it is recommended that you separate the large current GND pattern and small signal GND pattern and provide single point grounding at the reference point of the set so that voltage variation due to resistance components of the pattern wiring and large currents do not cause the small signal GND voltage to change. Take care that the GND wiring pattern of externally attached components also does not change.
- (11) Externally attached capacitors
When using ceramic capacitors for externally attached capacitors, determine constants upon taking into account a lowering of the rated capacitance due to DC bias and capacitance change due to factors such as temperature.
- (12) Thermal shutdown circuit (TSD)
When the junction temperature becomes higher than a certain specific value, the thermal shutdown circuit operates and turns the switch OFF. The thermal shutdown circuit, which is aimed at isolating the LSI from thermal runaway as much as possible, is not aimed at the protection or guarantee of the LSI. Therefore, do not continuously use the LSI with this circuit operating or use the LSI assuming its operation.
- (13) Thermal design
Perform thermal design in which there are adequate margins by taking into account the permissible dissipation (Pd) in actual states of use.
- (14) Rush Current
Extra care must be taken on power coupling, power, ground line impedance, and PCB design while excess amount of rush current might instantly flow through the power line when powering-up a LSI which is equipped with several power supplies, depending on on/off sequence, and ramp delays.

●Ordering part number

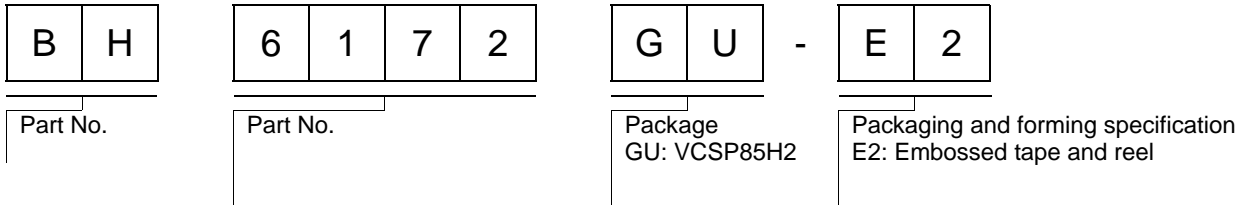

VCSP85H2(BH6172GU)

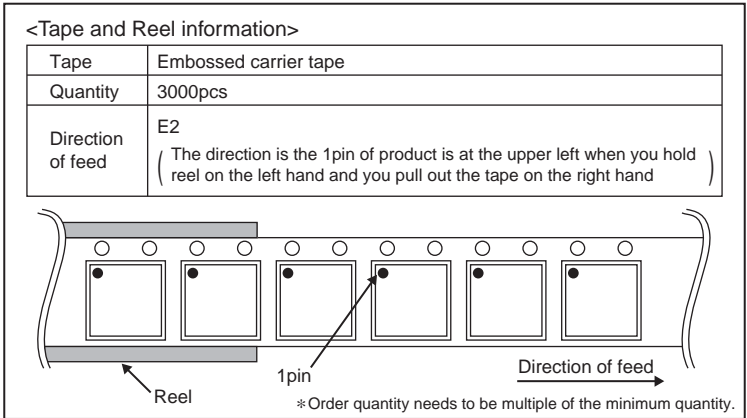
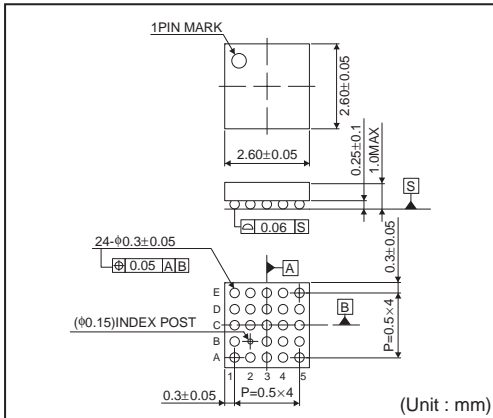

Notice

Precaution on using ROHM Products

- Our Products are designed and manufactured for application in ordinary electronic equipments (such as AV equipment, OA equipment, telecommunication equipment, home electronic appliances, amusement equipment, etc.). If you intend to use our Products in devices requiring extremely high reliability (such as medical equipment ^(Note 1), transport equipment, traffic equipment, aircraft/spacecraft, nuclear power controllers, fuel controllers, car equipment including car accessories, safety devices, etc.) and whose malfunction or failure may cause loss of human life, bodily injury or serious damage to property ("Specific Applications"), please consult with the ROHM sales representative in advance. Unless otherwise agreed in writing by ROHM in advance, ROHM shall not be in any way responsible or liable for any damages, expenses or losses incurred by you or third parties arising from the use of any ROHM's Products for Specific Applications.

(Note1) Medical Equipment Classification of the Specific Applications

JAPAN	USA	EU	CHINA
CLASS III	CLASS III	CLASS II b	CLASS III
CLASS IV		CLASS III	

- ROHM designs and manufactures its Products subject to strict quality control system. However, semiconductor products can fail or malfunction at a certain rate. Please be sure to implement, at your own responsibilities, adequate safety measures including but not limited to fail-safe design against the physical injury, damage to any property, which a failure or malfunction of our Products may cause. The following are examples of safety measures:
 - Installation of protection circuits or other protective devices to improve system safety
 - Installation of redundant circuits to reduce the impact of single or multiple circuit failure
- Our Products are designed and manufactured for use under standard conditions and not under any special or extraordinary environments or conditions, as exemplified below. Accordingly, ROHM shall not be in any way responsible or liable for any damages, expenses or losses arising from the use of any ROHM's Products under any special or extraordinary environments or conditions. If you intend to use our Products under any special or extraordinary environments or conditions (as exemplified below), your independent verification and confirmation of product performance, reliability, etc. prior to use, must be necessary:
 - Use of our Products in any types of liquid, including water, oils, chemicals, and organic solvents
 - Use of our Products outdoors or in places where the Products are exposed to direct sunlight or dust
 - Use of our Products in places where the Products are exposed to sea wind or corrosive gases, including Cl₂, H₂S, NH₃, SO₂, and NO₂
 - Use of our Products in places where the Products are exposed to static electricity or electromagnetic waves
 - Use of our Products in proximity to heat-producing components, plastic cords, or other flammable items
 - Sealing or coating our Products with resin or other coating materials
 - Use of our Products without cleaning residue of flux (even if you use no-clean type fluxes, cleaning residue of flux is recommended); or Washing our Products by using water or water-soluble cleaning agents for cleaning residue after soldering
 - Use of the Products in places subject to dew condensation
- The Products are not subject to radiation-proof design.
- Please verify and confirm characteristics of the final or mounted products in using the Products.
- In particular, if a transient load (a large amount of load applied in a short period of time, such as pulse. is applied, confirmation of performance characteristics after on-board mounting is strongly recommended. Avoid applying power exceeding normal rated power; exceeding the power rating under steady-state loading condition may negatively affect product performance and reliability.
- De-rate Power Dissipation (Pd) depending on Ambient temperature (Ta). When used in sealed area, confirm the actual ambient temperature.
- Confirm that operation temperature is within the specified range described in the product specification.
- ROHM shall not be in any way responsible or liable for failure induced under deviant condition from what is defined in this document.

Precaution for Mounting / Circuit board design

- When a highly active halogenous (chlorine, bromine, etc.) flux is used, the residue of flux may negatively affect product performance and reliability.
- In principle, the reflow soldering method must be used; if flow soldering method is preferred, please consult with the ROHM representative in advance.

For details, please refer to ROHM Mounting specification

Precautions Regarding Application Examples and External Circuits

1. If change is made to the constant of an external circuit, please allow a sufficient margin considering variations of the characteristics of the Products and external components, including transient characteristics, as well as static characteristics.
2. You agree that application notes, reference designs, and associated data and information contained in this document are presented only as guidance for Products use. Therefore, in case you use such information, you are solely responsible for it and you must exercise your own independent verification and judgment in the use of such information contained in this document. ROHM shall not be in any way responsible or liable for any damages, expenses or losses incurred by you or third parties arising from the use of such information.

Precaution for Electrostatic

This Product is electrostatic sensitive product, which may be damaged due to electrostatic discharge. Please take proper caution in your manufacturing process and storage so that voltage exceeding the Products maximum rating will not be applied to Products. Please take special care under dry condition (e.g. Grounding of human body / equipment / solder iron, isolation from charged objects, setting of ionizer, friction prevention and temperature / humidity control).

Precaution for Storage / Transportation

1. Product performance and soldered connections may deteriorate if the Products are stored in the places where:
 - [a] the Products are exposed to sea winds or corrosive gases, including Cl₂, H₂S, NH₃, SO₂, and NO₂
 - [b] the temperature or humidity exceeds those recommended by ROHM
 - [c] the Products are exposed to direct sunshine or condensation
 - [d] the Products are exposed to high Electrostatic
2. Even under ROHM recommended storage condition, solderability of products out of recommended storage time period may be degraded. It is strongly recommended to confirm solderability before using Products of which storage time is exceeding the recommended storage time period.
3. Store / transport cartons in the correct direction, which is indicated on a carton with a symbol. Otherwise bent leads may occur due to excessive stress applied when dropping of a carton.
4. Use Products within the specified time after opening a humidity barrier bag. Baking is required before using Products of which storage time is exceeding the recommended storage time period.

Precaution for Product Label

QR code printed on ROHM Products label is for ROHM's internal use only.

Precaution for Disposition

When disposing Products please dispose them properly using an authorized industry waste company.

Precaution for Foreign Exchange and Foreign Trade act

Since our Products might fall under controlled goods prescribed by the applicable foreign exchange and foreign trade act, please consult with ROHM representative in case of export.

Precaution Regarding Intellectual Property Rights

1. All information and data including but not limited to application example contained in this document is for reference only. ROHM does not warrant that foregoing information or data will not infringe any intellectual property rights or any other rights of any third party regarding such information or data. ROHM shall not be in any way responsible or liable for infringement of any intellectual property rights or other damages arising from use of such information or data.:
2. No license, expressly or implied, is granted hereby under any intellectual property rights or other rights of ROHM or any third parties with respect to the information contained in this document.

Other Precaution

1. This document may not be reprinted or reproduced, in whole or in part, without prior written consent of ROHM.
2. The Products may not be disassembled, converted, modified, reproduced or otherwise changed without prior written consent of ROHM.
3. In no event shall you use in any way whatsoever the Products and the related technical information contained in the Products or this document for any military purposes, including but not limited to, the development of mass-destruction weapons.
4. The proper names of companies or products described in this document are trademarks or registered trademarks of ROHM, its affiliated companies or third parties.

General Precaution

1. Before you use our Products, you are requested to carefully read this document and fully understand its contents. ROHM shall not be in any way responsible or liable for failure, malfunction or accident arising from the use of any ROHM's Products against warning, caution or note contained in this document.
2. All information contained in this document is current as of the issuing date and subject to change without any prior notice. Before purchasing or using ROHM's Products, please confirm the latest information with a ROHM sales representative.
3. The information contained in this document is provided on an "as is" basis and ROHM does not warrant that all information contained in this document is accurate and/or error-free. ROHM shall not be in any way responsible or liable for any damages, expenses or losses incurred by you or third parties resulting from inaccuracy or errors of or concerning such information.

X-ON Electronics

Largest Supplier of Electrical and Electronic Components

Click to view similar products for [LDO Voltage Regulators](#) category:

Click to view products by [ROHM](#) manufacturer:

Other Similar products are found below :

[M38D29FFHP#U1](#) [702103A](#) [717726C](#) [742457H](#) [MP20051DN-LF-Z](#) [R5F111PGGFB#30](#) [AP7363-SP-13](#) [NCP103AMX285TCG](#)
[NCV8664CST33T3G](#) [NCV8752AMX28TCG](#) [L9454](#) [AP7362-HA-7](#) [LX13043CLD](#) [TCR3DF185,LM\(CT](#) [TCR3DF24,LM\(CT](#)
[TCR3DF285,LM\(CT](#) [TCR3DF31,LM\(CT](#) [TCR3DF45,LM\(CT](#) [TLF4949EJ](#) [MP2013GQ-33-Z](#) [L9708](#) [L970813TR](#) [030014BB](#) [059985X](#)
[NCP121AMX173TCG](#) [NCP4687DH15T1G](#) [701326R](#) [702087BB](#) [755078E](#) [TCR2EN28,LF\(S](#) [LM1117DT-1.8/NO](#) [LT1086CM#TRPBF](#)
[AZ1085S2-1.5TRE1](#) [MAX15101EWL+T](#) [NCV8170AXV250T2G](#) [TCR3DF27,LM\(CT](#) [TCR3DF19,LM\(CT](#) [TCR3DF125,LM\(CT](#)
[TCR2EN18,LF\(S](#) [MAX15103EWL+T](#) [TS2937CZ-5.0 C0](#) [MAX8878EUK30-T](#) [MAX663CPA](#) [NCV4269CPD50R2G](#) [NCV8716MT30TBG](#)
[AZ1117IH-1.2TRG1](#) [MP2013GQ-P](#) [AP2112R5A-3.3TRG1](#) [AP7315-25W5-7](#) [MAX15102EWL+T](#)